

cuboDock

Made for
iPod iPhone

Instruction Manual



sonoro

sonoro audio GmbH

Unter Goldschmied 6
50667 Köln
Germany

info@sonoro-audio.com
www.sonoro-audio.com

10/10

The manufacturer continuously works on the further development of all types and models. We ask for your understanding that changes of the scope of delivery in regard to form, components and technology are therefore possible at any time. The information, illustrations and descriptions in this manual therefore shall not constitute an entitlement to any claims.

Replication, copying or translation, even in parts, is not permitted without the written consent of the manufacturers. The manufacturer explicitly reserves all rights pursuant to the law governing the copyright. Subject to changes.

“Made for iPod” and “Made for iPhone” mean that an electronic accessory has been designed to connect specifically to iPod or iPhone, respectively, and has been certified by the developer to meet Apple performance standards. Apple is not responsible for the operation of this device or its compliance with safety and regulatory standards. Please note that the use of this accessory with iPod or iPhone may affect wireless performance.

iPod and iPhone are trademarks of Apple Inc., registered in the U.S. and other countries.

Contents

| | | |
|-----------|---|-----------|
| 1. | Introduction | 3 |
| 2. | Safety Instructions | 3 |
| 2.1 | Symbols in this Operating Manual | 3 |
| 2.2 | Intended Use | 3 |
| 2.3 | Children and Persons with Limited Cognitive Abilities | 3 |
| 2.4 | Power Supply | 3 |
| 2.5 | Battery | 4 |
| 2.6 | Transport | 4 |
| 2.7 | Environmental Conditions | 4 |
| 2.8 | Operation | 4 |
| 2.9 | Defect | 4 |
| 2.10 | Cleaning | 5 |
| 2.11 | Disposal | 5 |
| 3. | Scope of Delivery | 5 |
| 4. | Unpack Device and Start Operation | 5 |
| 4.1 | Unpack Device | 5 |
| 4.2 | Insert Batteries | 6 |
| 4.3 | Establish Power Supply | 6 |
| 4.4 | Prepare iPod Docking Station | 6 |
| 5. | LED colour Indication on the unit | 7 |
| 6. | Technical Data | 14 |
| 7. | Warranty | 15 |

1. Introduction

Congratulations on purchasing a sonoro cuboDock.

This operating manual provides you with all information concerning the correct and safe operation of the device.

- Please read this operating manual in its entirety before using the device.
- Keep these instructions at a safe place.
- In case you pass this device on to a third party, please also include the operating manual.
- Non-compliance with this manual may lead to serious injuries and damage to the device.
- We may not be held liable for damage that was caused due to non-compliance with this operating manual.
- Please take special note of the chapter „Safety Instructions“.

The illustrations in this operating manual serve the purpose to visualize processes.

Enjoy your device!

2. Safety Instructions

2.1 Symbols in this Operating Manual

Important information relative to your safety is especially marked. It is imperative that you adhere to this information to avoid accidents and damage to the device:



RISK!

Warning concerning risks to your health and indication of potential risk of injury.



WARNING!

Indicates potential risks for the device and other objects.



NOTE!

Highlights tips and information for you.

2.2 Intended Use

The device is only for private use. It is not suitable for commercial use. The device is exclusively intended for the following tasks:

- Play audio directly from an iPod/iPhone, charging function for the iPod/iPhone
- Play audio for external devices that are connected via AUX.
- Play audio from external devices that are connected via Bluetooth

Any other use is not intended and is prohibited. We may not be held liable for damage caused through unintended use.

2.3 Children and Persons with Limited Cognitive Abilities

- Do not leave the device unattended and do not use it if children or people are in close range who may not be able to assess the associated risks.
- Persons (including children) who based on their physical, sensory or mental capacities or their inexperience or lack of knowledge are not able to safely use this device may not use this device without supervision or without instructions provided by a responsible person. Please store this device at an inaccessible location.
- Packaging material may not be used for playing. It presents a suffocation risk.

2.4 Power Supply

The device is powered by electricity; therefore there is always a risk of an electric shock. For this reason, especially adhere to the following instructions:

- Never touch the power plug with wet hands.
- If you want to pull the plug from the power outlet, always pull directly on the plug. Never pull on the cable, it may rip.

- Please ensure unobstructed access to the utilized power outlet at all times, so that the plug can be pulled immediately in case of an emergency.
- Please ensure that the electric cord is not bent, wedged or rolled over. Install the electric cord so that it cannot become a tripping hazard and so that it is out reach for children.
- Only use extension cords that are designed to handle the power input of the device.
- Keep the device away from rain and moisture as well as from any heat sources
- Only operate the device when the electric voltage on the type label of the device and on the plug match the voltage of your electrical outlet. An incorrect voltage can destroy the device.
- If you will not use the device for a longer period of time, separate the device completely from the power supply system to prevent a potential fire hazard. For that, pull the plug from the electrical outlet.

2.5 Battery

- Remove battery from the battery compartment of the remote control as soon as it is empty or if the device will not be used for a longer period of time.
- Do not throw the battery in a fire and never make them subject to high temperatures.
- Never try to recharge battery. Do not try to open or short-out battery. This may present an explosion hazard.
- Liquid that leaks during the incorrect use of the batteries may cause skin irritations. In the event of direct contact with the liquid, wash it off with plenty of water. When the liquid gets into the eyes, do not rub the eyes. Flush the eyes with water for 10 minutes and immediately seek medical assistance.

2.6 Transport

- To avoid damage to the inserted iPods/iPhones, please remove it from the device prior to transport/shipping.
- Store the device during the transport in a vehicle in such a fashion that the occupants are not endangered.
- If you ship the device, pack it in the original packaging. Therefore, keep the packaging.

2.7 Environmental Conditions

The safe operation of the device requires appropriate environmental conditions. Therefore, please adhere to the following:

- Protect the device from exposure to effects imposed by the weather. Never use it outside and never set it up at locations that are subject to significant direct sunlight.
- Never place the device on or in immediate proximity of fire or heat sources such as for example burning candles, stove tops, ovens etc.
- Set up the device so that sufficient air supply is guaranteed. This will avoid heat accumulation on the inside of the device. Always keep a minimum distance of 10 cm to other devices or walls. The distance between the backside of cuboDock and a wall behind influences the sound performance. Vary the distance according to your taste: The less the distance the stronger the bass.
- Protect the device from strong mechanical vibrations and place it on solid surfaces.
- Protect the remote control from effects imposed by the weather, moisture and high temperatures (e.g. from direct sunlight).
- Protect the device from splashing or dripping water. Never place a container filled with liquid next to or onto the device.



RISK!

Never install/ remove the batteries that came with the device in an environment that bears the potential risk of explosions (e. g. gas station areas, fuel lines, gasoline storage areas, areas where the air may contain chemicals or explosive particles/dust (e. g. flour dust or metal powder) or areas in which you have been instructed to turn off the engine of your vehicle). This may present an explosion hazard.

2.8 Operation

- Never place any other than the approved iPod/iPhone types into the iPod/iPhone docking station.
- cuboDock is a very powerful device. Put it on a stable ground to enjoy the full sound without vibration noises.

2.9 Defect

Never try to fix your device on your own if it becomes defective.

- If the power plug, the adapter or the power cord of this device is damaged, they must be replaced by the manufacturer or the manufacturer's customer service to avoid the risk of electric shock.
- If liquid gets into the device or if the device was dropped or otherwise damaged, it must be checked by an authorized dealer. Separate the device from the power supply and contact an authorized dealer.

2.10 Cleaning

- Only use a dry, soft cloth to clean the exterior surfaces of the device. Never use any abrasive or dissolvent cleaning agents, because these may damage the surface of the device.
- If the device is extremely dirty, it may also be wiped down with a slightly moist cloth and dried with a dry, soft cloth.

2.11 Disposal

Devices that are marked with the symbol on the right may not be disposed of with the regular household trash, but must be dropped off at a recycling center for electric and electronic devices.



Batteries/ rechargeable batteries may contain toxic heavy metals and are subject to special refuse treatment. Drop off the batteries/rechargeable batteries at a communal collection site or bring them to a specialized store for disposal.

Please consider that your electronic entertainment device is subject to the European guideline 2002/96/EC for the reduction of electronic waste.

- Therefore please note that you are not permitted to dispose of your device in your household waste.
- You can receive information regarding the disposal of old devices at the municipal administration, the waste disposal administration and the store where you purchased this product
- You can drop off your device free of charge at communal collection points.
- With the proper disposal of old devices you prevent environmental damage and don't damage your health.

3. Scope of Delivery

- sonoro cuboDock (with bag)
- Remote control
- 3 bumpers
- Universal power supply adapter
- Button cell battery
- Gloves
- Operating manual

4. Unpack Device and Start Operation

You may only use connecting cables and external devices that comply with this device in regard to electromagnetic compatibility and insulation quality. This device fulfills all relevant standards and guidelines in conjunction with US and European regulation. In the event of a device change that has not been coordinated with the manufacturer, the compliance with the standards and guidelines is no longer guaranteed. Only use the accessories listed by the manufacturer.



RISK!

Playing with packaging material presents a suffocation risk!

Playing with packaging material presents a suffocation risk. Keep the packaging material out of the reach of children and persons who may not be able to assess the risks.

4.1 Unpack Device

1. Unpack the device and all accessories and check the content for completeness and proper condition.



NOTE!

In case you detect damage due to transportation or if parts of the packet are missing, contact your dealer immediately.

2. Set up the device at a suitable location. Adhere to the security instructions concerning the environmental conditions.

4.2 Insert Batteries

For installation please refer to Figure 10.



RISK!

Injury hazard due to incorrect handling of batteries!

Battery must be treated with special care.

- Remove battery from of the battery compartment as soon as it is empty or if the device will not be used for a longer period of time.

- Do not throw battery into a fire and never make them subject to high temperatures.

- Do not try to recharge standard batteries. This may present an explosion hazard. Do not try to open or short-out the battery.

- Leaking liquid in conjunction with an incorrect use of batteries may cause skin irritations. In the event of contact with the liquid, wash it off with plenty of water. If the liquid gets into the eyes, do not rub the eyes. Flush the eyes with water for 10 minutes and immediately seek medical assistance.

4.3 Establish Power Supply

The device is powered via the power supply unit that comes with the packet. The power supply unit with the universal adapter must be assembled prior to its first use.



RISK!

Injury hazard due to inappropriate handling!

Improper handling of the universal power supply unit may result in the risk of an electric shock.

- Make sure that the power supply unit and the universal adapter are always firmly connected with each other.

- Pull the power supply unit with the universal adapter from the outlet in a strait motion so that the adapter will not break off the mounting.



WARNING!

Property damage due to incorrect voltage connection

Connection values that exceed the permissible maximum values of the device can destroy the device.

- Only use the power supply unit that came with the device.

- Only operate the device when the voltage indicated on the power supply unit matches the voltage on your electrical outlet.

1. Slide the universal adapter onto the power supply unit until it has snapped into position.
2. Plug the connecting plug of the power supply into the 16V \approx 2.5A DC port on the back of the device.
3. Plug the power plug into an electrical outlet.

4.4 Prepare iPod Docking Station



WARNING!

Physical damage through improper operation!

Pointy or sharp edged objects may damage the PIN connector.

- Do not use any such objects to insert or remove the dock adapter.

Declaration of Conformity

Manufacturer: sonoro audio GmbH

We herewith declares that the sonoro cuboDock is in conformity with the EMC directive 2004/108/EC, the LVD directive 2006/95/EC and R&TTE directive 1999/5/EC; with respect to its conception and style of construction as well as its performance as issued by us.



In the case of a modification, unauthorized by sonoro audio GmbH being made to the device, the declaration loses its validity automatically.

The full description of conformity can get from support@sonoro-audio.com

5. LED colour Indication on the unit

| Mode | Operating | LED Indicator Colour |
|-----------------------|-------------------------|-----------------------|
| Standby | | Red |
| iPod | Playback / Pause | Green |
| (iPod is plugged) | Volume +/- | Green - fast flashing |
| | Fast Forward / Backward | Green - slow flashing |
| | Mute | Green - slow flashing |
| (iPod is not plugged) | | Green - fast flashing |
| Bluetooth | Not pairing | Blue - fast flashing |
| | Paired, playback | Blue |
| | Pause | Blue - slow flashing |
| | Volume +/- | Blue - fast flashing |
| | Mute | Blue - slow flashing |
| AUX IN | | Amber |
| | Volume +/- | Amber - fast flashing |
| | Mute | Amber - slow flashing |

Figure 1

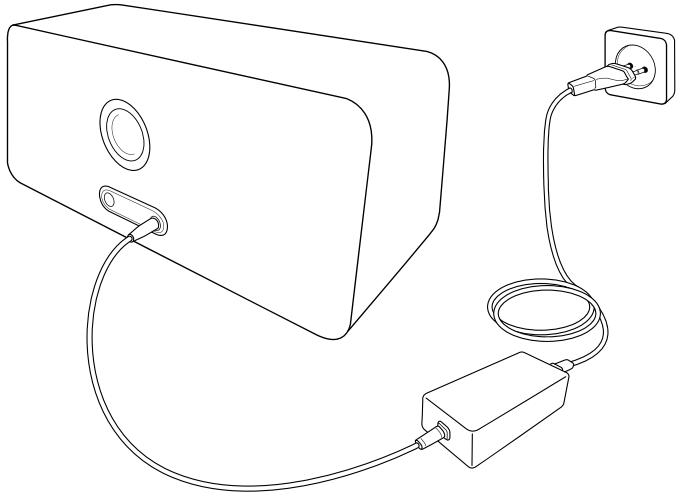

Figure 2

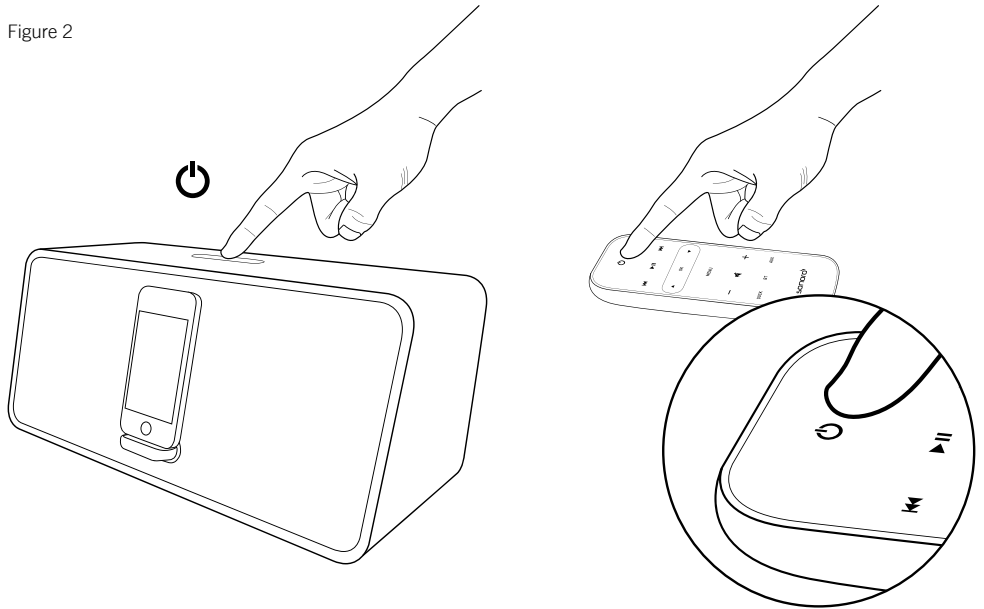

Figure 3

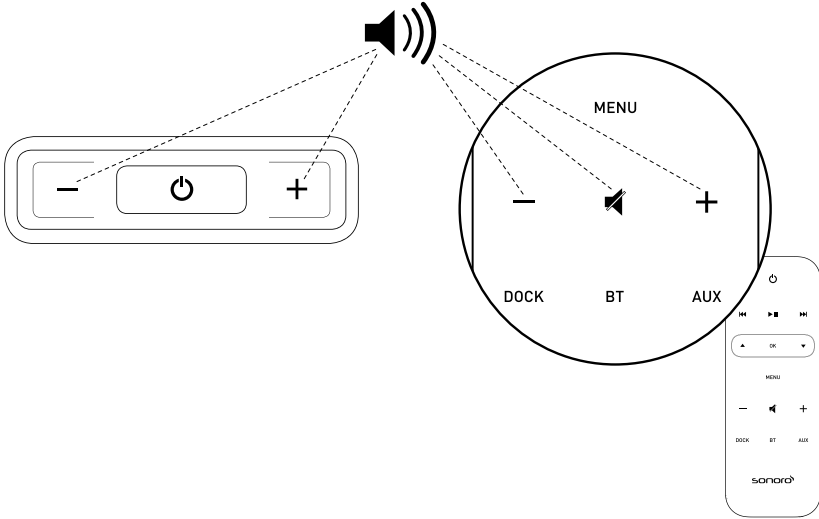

Figure 4

iPod Operation

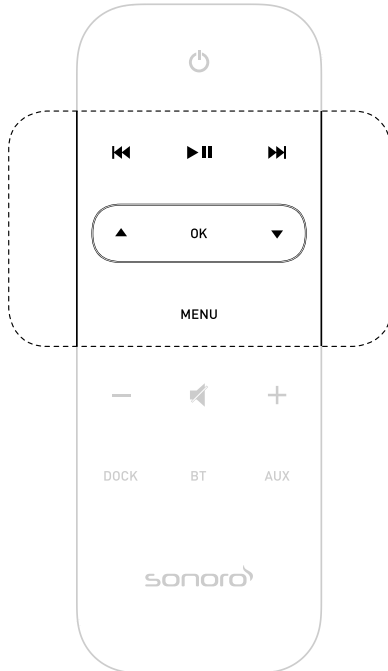

Figure 5

Bluetooth

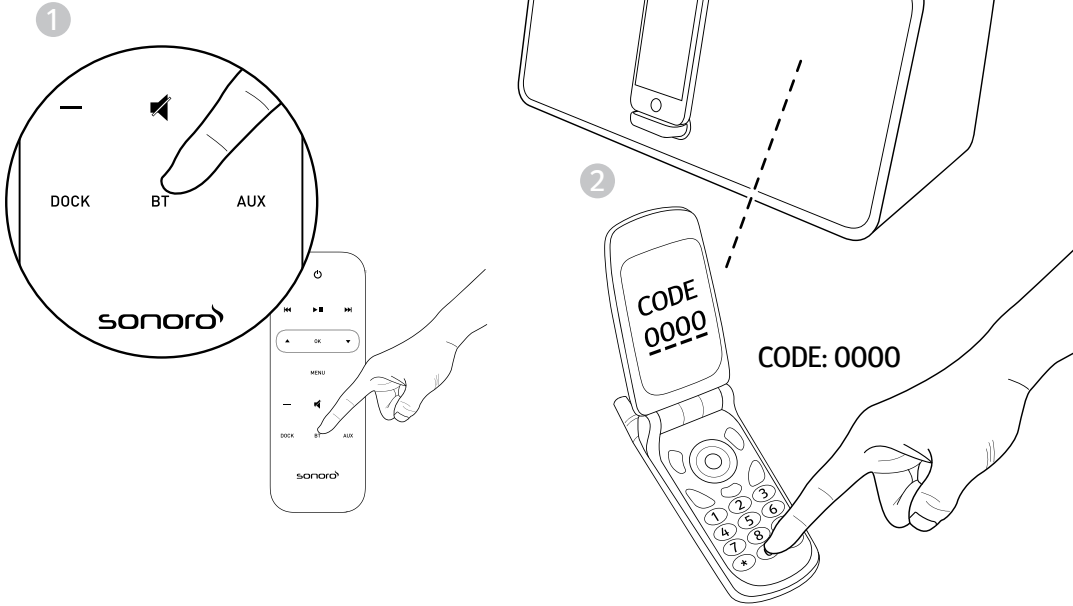

Figure 6

AUX

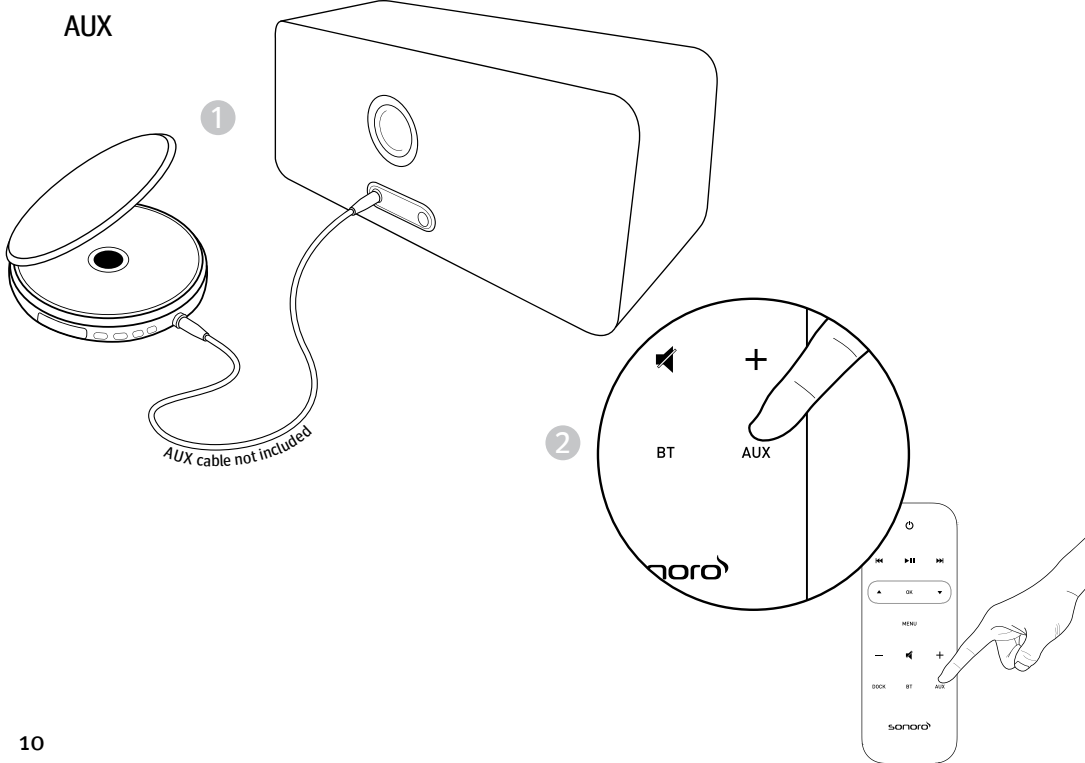

Figure 7

iPod

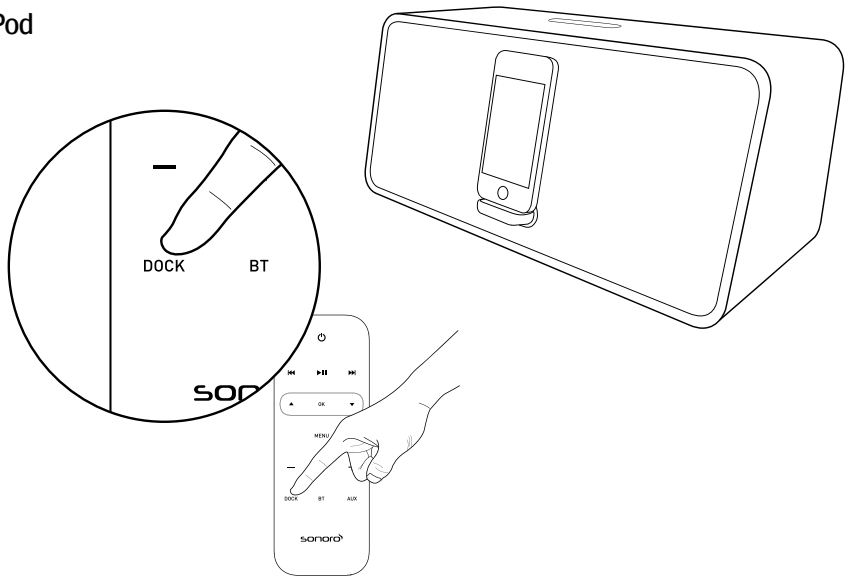
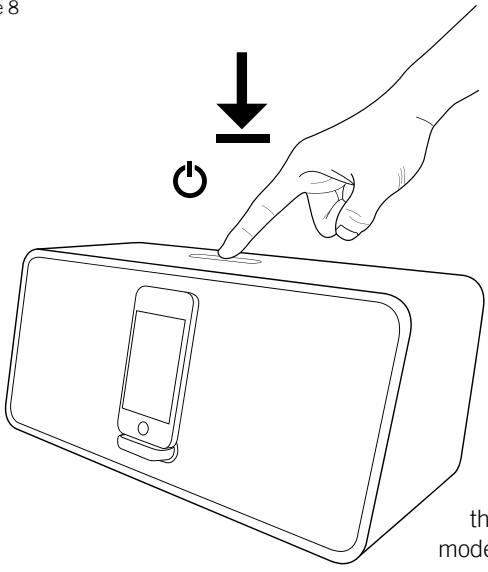

Figure 8











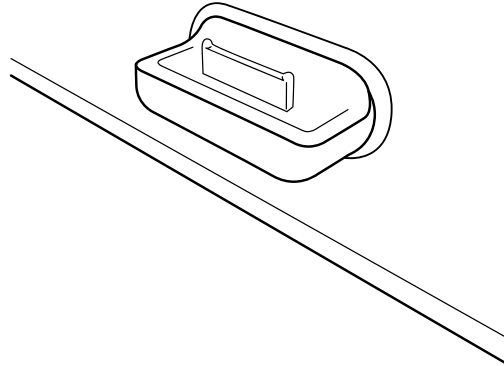
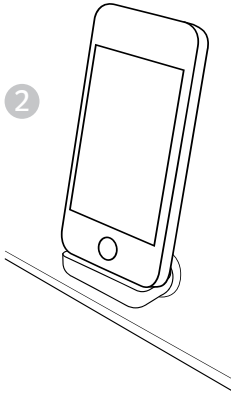
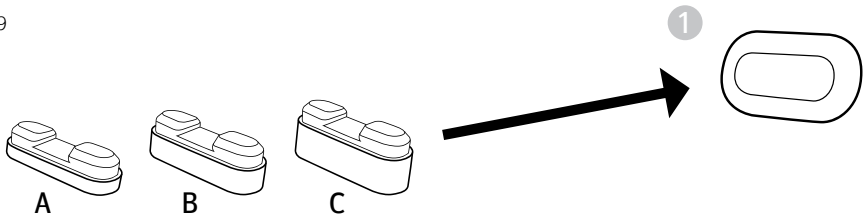





When unit is switched ON press and hold the main unit standby key for about 1.5 seconds, then release it, and it will change the operating modes one by one.

Unit is switched on:

..... iPod → Bluetooth → AUX → iPod

Figure 9



| iPod Model | Bumper |
|---|--------|
|  iPod 3rd generation 10GB 15GB 20GB | A |
|  iPod 3rd generation 30GB 40GB | A |
|  iPod 4th generation 20GB | A |
|  iPod 4th generation 40GB | A |
|  iPod 4th generation (color display) 20GB 30GB | A |
|  iPod 4th generation (color display) 40GB 60GB | A |
|  iPod 5th generation (video) 30GB | B |
|  iPod 5th generation (video) 60GB 80GB | A |
|  iPod mini 4GB 6GB | A |
|  iPod classic 80GB | B |
|  iPod classic 160GB (2007) | A |
|  iPod classic 160GB (2009) | A |
|  iPod nano 1st generation 1GB 2GB 4GB | C |













| iPod Model | Bumper |
|---|--------|
|  iPod nano 2nd generation (aluminum) 2GB 4GB 8GB | C |
|  iPod nano 3rd generation (video) 4GB 8GB | C |
|  iPod nano 4th generation (video) 8GB 16GB | C |
|  iPod nano 5th generation (video camera) 8GB 16GB | C |
|  iPod nano 6th generation 8GB 16GB | — |
|  iPod touch 1st generation 8GB 16GB 32GB | B |
|  iPod touch 2nd generation 8GB 16GB 32GB | B |
|  iPod touch 3rd generation 32GB 64GB | B |
|  iPod touch 4th generation 8GB 32GB 64GB | C |
|  iPhone 4GB 8GB 16GB | A |
|  iPhone 3G 8GB 16GB | A |
|  iPhone 3GS 8GB 16GB 32GB | A |
|  iPhone 4 16GB 32GB | B |

Figure 10

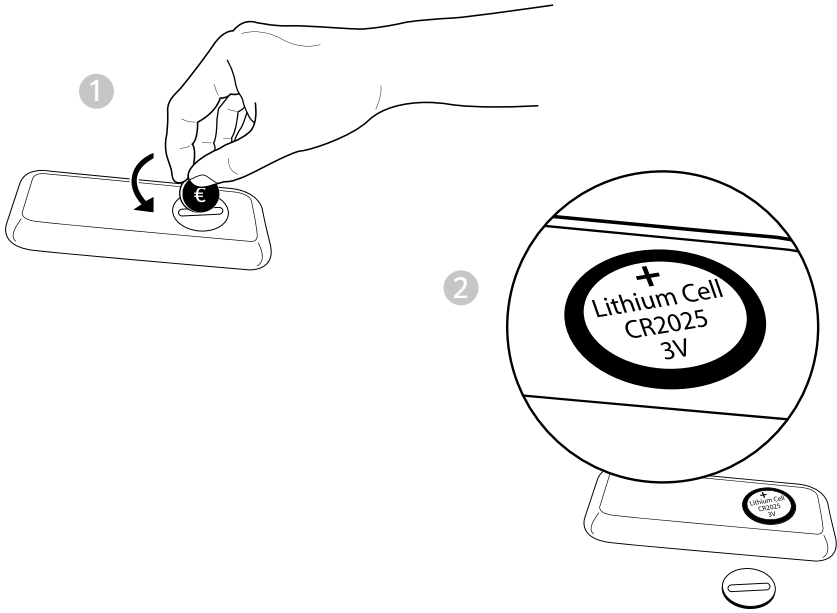
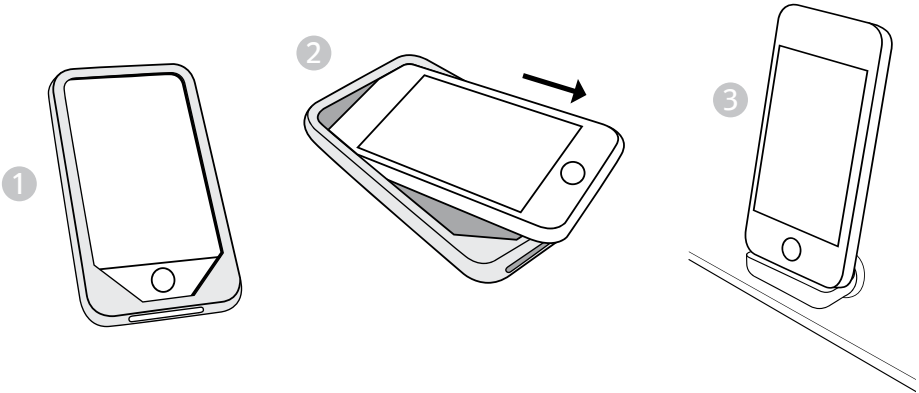

Figure 11



7. Warranty

The following applies to the filing of warranty claims - without thereby limiting your legal rights:

- Warranty claims may only be asserted within a time period of no more than two years (one year for North America) starting with the date of purchase.
- Within the warranty period we will rectify all defects that are based on material or manufacturing defects at our discretion either through repair or a replacement of the device.
- Please contact your authorized dealer or send the defective device together with the warranty card and the proof of purchase to the service address. The repair or replacement of the device will not start a new warranty period. The warranty period of 2 years (one year for North America) from the purchase date remains the deciding factor.
- Damages due to improper use, normal wear and tear as well as defects that impact the value or the usability of the device only insignificantly are excluded from the warranty. Procedures that were performed by any unauthorized agent will also terminate the warranty.



cuboDock

Warranty card

AU-7000

Last name

Serial number

First name

Street address

City / State/ ZIP

Phone

Statement of defect

E-mail

Signature of customer

sonoro

