





















Half Milano Gazebo



| | | |
|----|--|----|
| A |  | 1 |
| B |  | 1 |
| C |  | 1 |
| C1 |  | 1 |
| D |  | 4 |
| E |  | 2 |
| F |  | 4 |
| G |  | 2 |
| H |  | 2 |
| I |  | 2 |
| J |  | 16 |
| K |  | 4 |
| L |  | 8 |
| M |  | 24 |
| N |  | 10 |
| O |  | 16 |
| P |  | 4 |
| Q |  | 1 |
| R |  | 1 |
| S |  | 4 |
| T |  | 1 |

1

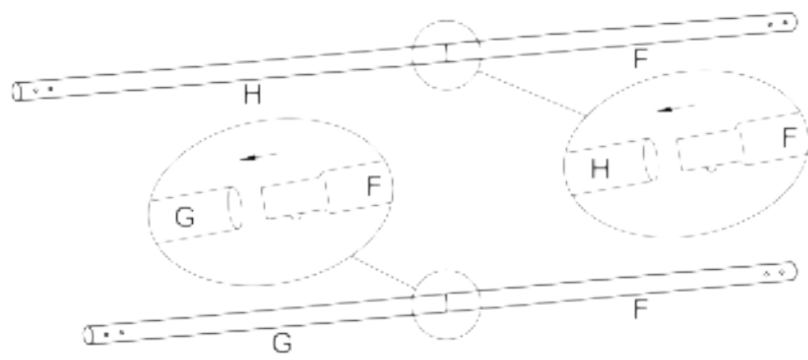

2

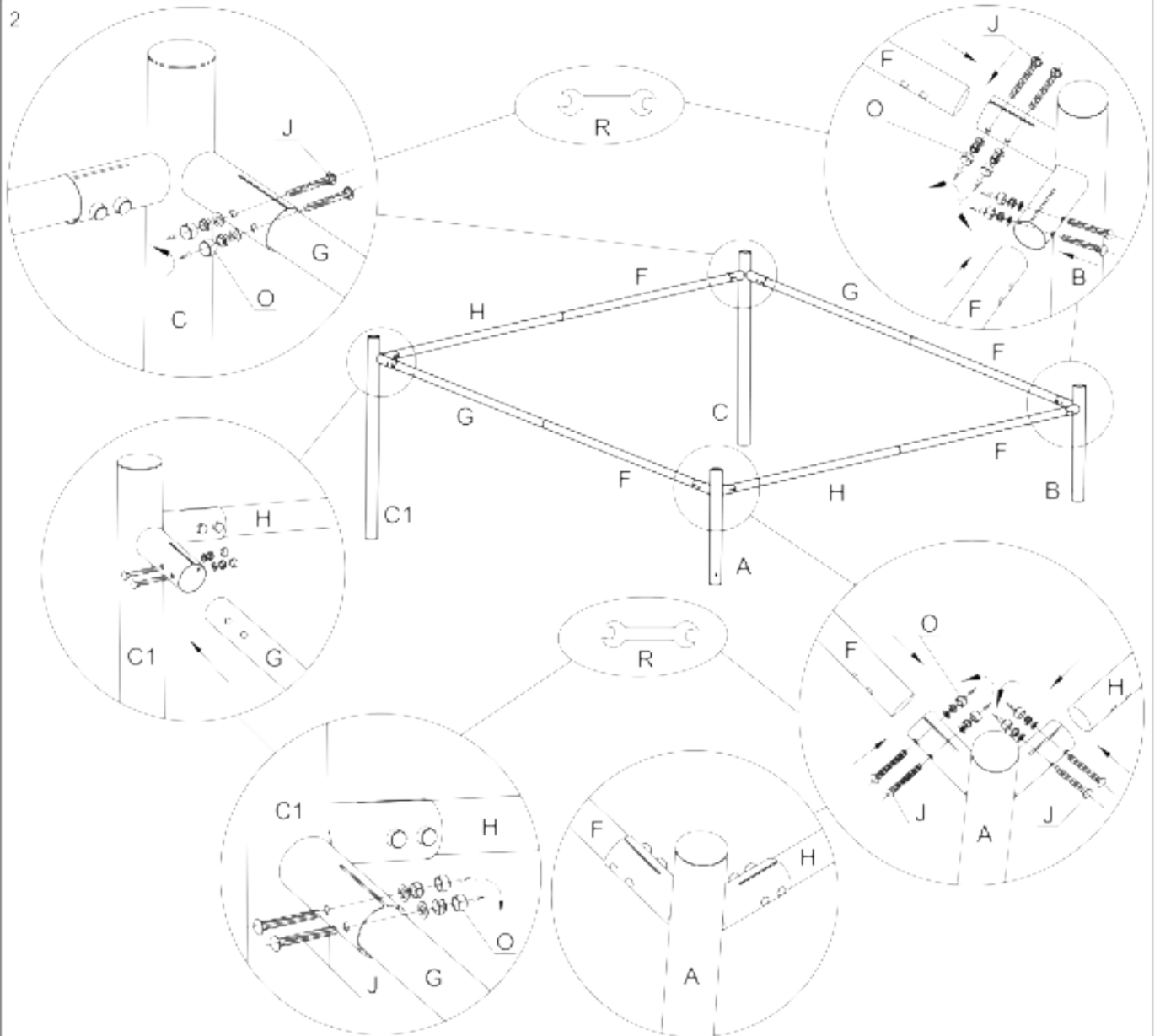

3

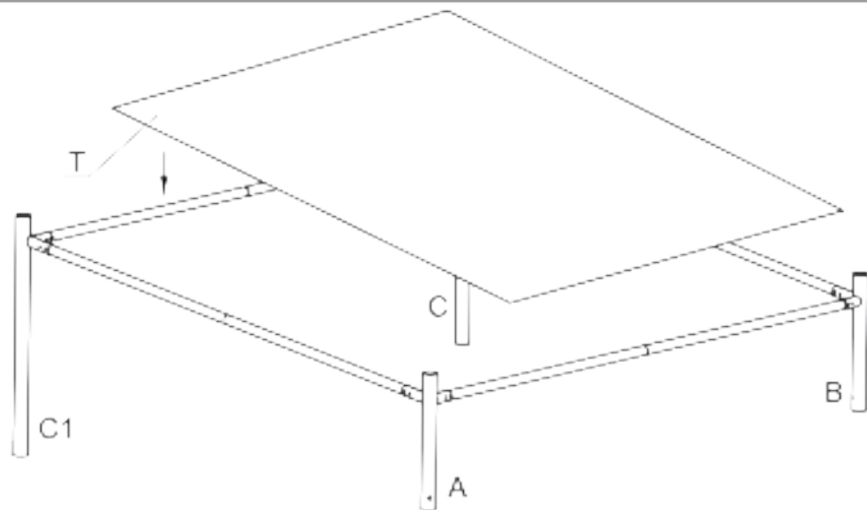

4

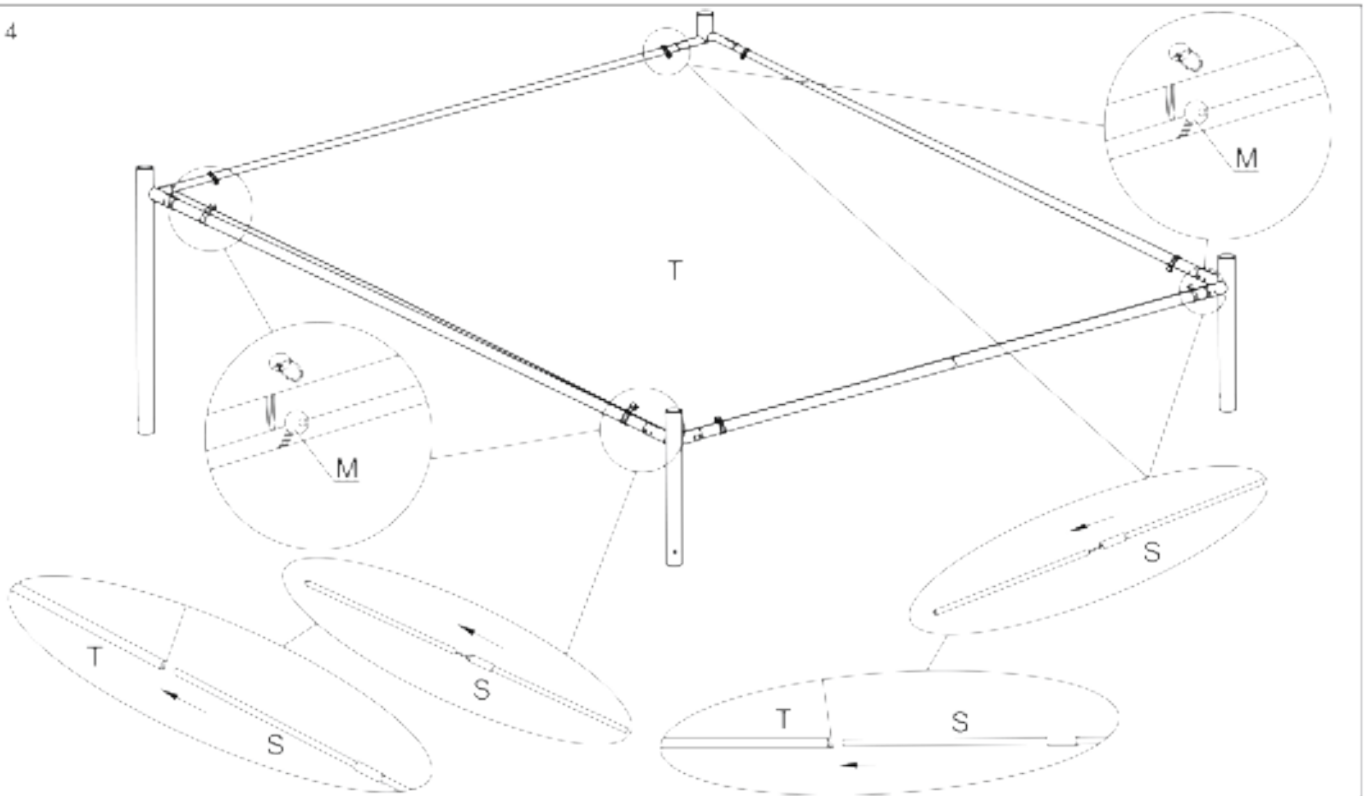

5

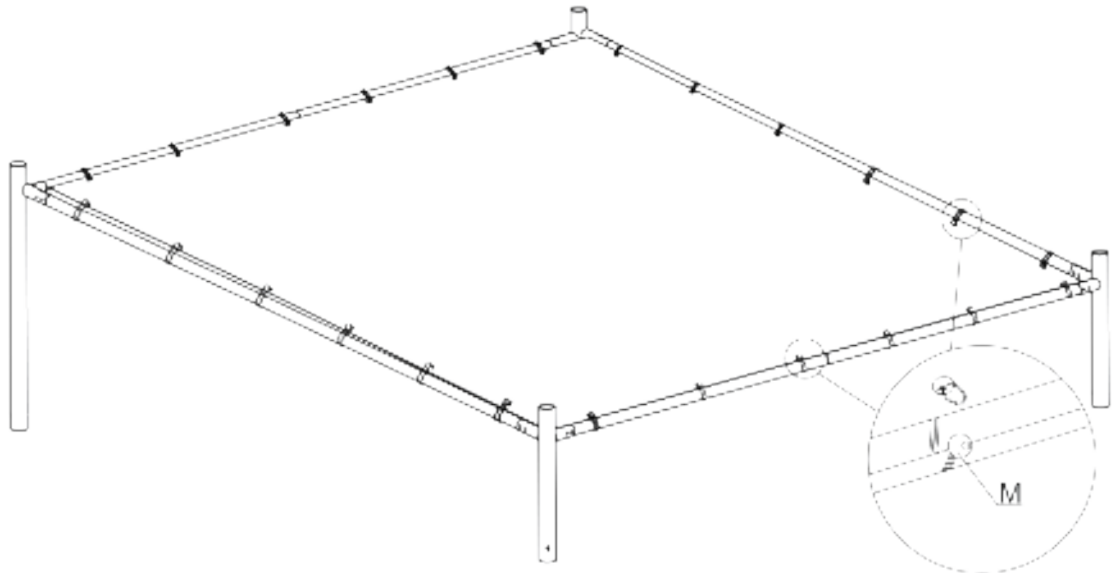

6

