

Instant™

VORTEX™

3.8 AND 5.7 LITRES AIR FRYERS



- 3** Important safeguards
- 7** Welcome
- 7** Product, parts and accessories
- 8** Get started
- 10** Control panel
- 13** Cooking
- 17** Care, cleaning and storage
- 18** Troubleshooting
- 19** Warranty
- 21** Contact



Table of contents

Getting Started Guide

User manual.....	1
Special lead set instructions.....	5
Product specifications	6
Find your model name and serial number	6
Welcome to the world of Instant Cooking	7
Product, parts and accessories	7
Air fryer	7
Get started.....	8
Initial set-up	8
Is anything missing or damaged?	8
Initial test run	9
Control panel	10
Settings.....	11
Cooking status.....	12
Status messages.....	12
Cooking	13
Air Fry, Roast and Bake.....	13
Cooking tips	15
Reheat.....	16
Care, cleaning and storage	17
Troubleshooting.....	18
Warranty.....	19
Contact.....	21

IMPORTANT SAFEGUARDS



At Instant Brands™ your safety always comes first. The Instant™ Vortex™ family was designed with your safety in mind, and we mean business. Visit instantpot.co.uk to learn about this appliance's safety mechanisms.

When using electrical appliances, basic safety precautions should always be followed:

- 01 READ ALL INSTRUCTIONS, SAFEGUARDS AND WARNINGS BEFORE OPERATING THE APPLIANCE. FAILURE TO FOLLOW THESE SAFEGUARDS AND INSTRUCTIONS MAY RESULT IN INJURY AND/OR PROPERTY DAMAGE.**
- 02** Always operate the appliance on a stable, non-combustible, heat-resistant, level surface.
- 03** The appliance's outer surfaces may become hot during use. Do not touch hot surfaces. Wear oven gloves when opening the Air Fryer and handling hot components. Extreme caution must be used when moving the appliance. Allow the appliance to cool to room temperature before handling or moving.
- 04** **⚠ CAUTION** To protect against the risk of electric shock, do not immerse the power lead, plug or appliance in water or other liquid.
- 05** Do not rinse appliance under the tap.
- 06** The cooking chamber contains electrical components. To avoid electric shock, do not put liquid of any kind into the cooking chamber.
- 07** This appliance is NOT to be used by children or by persons with reduced physical, sensory or mental capabilities, or lack of experience and knowledge. Close supervision is necessary when any appliance is used near children and these individuals. Children should not play with, clean or perform maintenance on this appliance.
- 08** Unplug from the socket when not in use, as well as before adding or removing parts or accessories, and before cleaning. To unplug, take hold of the plug and pull it from the socket. Never pull from the power lead.
- 09** Avoid contact with moving parts.

⚠ WARNING

Read this manual carefully and completely and retain for future reference. Failure to adhere to safety instructions may result in serious injury or damage.

IMPORTANT SAFEGUARDS



- 10 Regularly inspect the appliance and power lead. Do not operate any appliance with a damaged lead or plug or after the appliance malfunctions, or is dropped or damaged in any manner. Contact Customer Care at **UKSupport@instantbrands.com** or on **+44 (0) 3331 230051**.
- 11 Do not use any accessories or attachments not authorised by Instant Brands Inc. The use of attachments not recommended by the manufacturer, such as frying baskets, may cause a risk of injury, fire or electric shock.
- 12 For household countertop use only. Do not use outdoors. Not for commercial use. Not for use in staff kitchen areas in shops, offices and other working environments, in farmhouses, or by clients in hotels, motels and other residential type environments such as bed and breakfasts.
- 13 Do not place the appliance on any kind of hob, or in a heated oven; heat from an external source will damage the appliance.
- 14 Do not let power lead come into contact with hot surfaces or open flames, including hobs.
- 15 Do not use the appliance for anything other than its intended use.
- 16 Proper maintenance is recommended after each use. Refer to “Care, Cleaning & Storage”. Allow the appliance to cool to room temperature prior to cleaning or storage.
- 17 **⚠ CAUTION** Spilled food can cause serious burns. A short power-supply lead is provided to reduce the hazards resulting from grabbing, entanglement and tripping. Keep the appliance and lead away from children. Never drape the lead over the edge of a table or counter, never use a power socket below the counter, and never use with an extension lead.
- 18 Do not attempt to repair, replace, alter or modify components of the appliance. This may cause electric shock, fire and/or injury, and will void the warranty.
- 19 Do not tamper with any of the safety mechanisms.
- 20 Do not use the appliance in electrical systems other than 220–240 V~ 50–60Hz. Do not use with power converters or adapters.

⚠ WARNING

Read this manual carefully and completely and retain for future reference. Failure to adhere to safety instructions may result in serious injury or damage.

IMPORTANT SAFEGUARDS



- 21 Do not overfill the air fryer basket. Overfilling may cause food to come into contact with the heating element, which may result in fire and/or personal injury.
- 22 Do not cover the air vents while the appliance is in operation. Doing so will prevent even cooking and may cause damage to the appliance.
- 23 Never pour oil into the cooking chamber. Fire and personal injury could result.
- 24 The internal temperature of the appliance reaches several hundred degrees while cooking. To avoid personal injury, never place unprotected hands inside the appliance until it has cooled to room temperature.
- 25 When cooking, do not place the appliance against a wall or against other appliances. Do not operate the appliance on or near combustible materials such as tablecloths and curtains. Do not place anything on top of the appliance.
- 26 When in operation, hot air is released through the air vents. Keep your hands and face at a safe distance from the air vents and take extreme caution when removing the accessories from the appliance.
- 27 Should the unit emit black smoke, press Cancel and unplug the appliance immediately. Wait for smoking to stop before removing the air fryer basket, then clean the appliance thoroughly.
- 28 Do not leave the appliance unattended while in use.
- 29 Never connect this appliance to an external timer switch or separate remote control system.
- 30 Use extreme caution when removing hot accessories from the cooking chamber or disposing of hot grease.
- 31 Oversized foods and/or metal utensils must not be inserted into the cooking chamber as they may cause a risk of fire and/or personal injury.
- 32 Do not store any materials, other than the included accessories, in the cooking chamber when not in use.
- 33 Do not place any combustible materials in the cooking chamber, such as paper, cardboard, plastic, polystyrene or wood.
- 34 The included accessories are not to be used in a microwave, toaster

WARNING

Read this manual carefully and completely and retain for future reference.
Failure to adhere to safety instructions may result in serious injury or damage.

IMPORTANT SAFEGUARDS



oven, convection or conventional oven, or on a ceramic, electric, induction or gas hob, or an outdoor grill.

SAVE THESE INSTRUCTIONS.

⚠ WARNING

To avoid injury, read and understand the instructions in this user manual before attempting to use this appliance.

⚠ WARNING

Electric shock hazard. Use earthed socket only.

- DO NOT remove earthing.
- DO NOT use an adapter.
- DO NOT use an extension lead.

Failure to follow these instructions may result in electric shock and/or serious injury.

⚠ WARNING







THE FAILURE TO FOLLOW ANY OF THE IMPORTANT SAFEGUARDS AND/OR THE INSTRUCTIONS FOR SAFE USE IS A MISUSE OF YOUR APPLIANCE THAT CAN VOID YOUR WARRANTY AND CREATE THE RISK OF SERIOUS INJURY.

Special lead set instructions

As per CE safety requirements, a short power supply lead is provided to reduce the hazards resulting from grabbing, entanglement and tripping.

This appliance has an earthed plug. To reduce the risk of electric shock, plug the power lead into an earthed and easily accessible electric socket.

Product specifications

					
Vortex 4	1400 - 1650 W	220-240 V ~ 50-60 Hz	3.7 Litres	3.92 kg	cm: 25.7D x 33.1W x 28.0H
Vortex 6	1450-1700 W	220-240 V~ 50-60Hz	5.7 Litres	5.48 kg	cm: 37.9D x 31.4W x 32.6H

Find your model name and serial number

Find both of these on the rating label on the back of the air fryer, near the power lead.

⚠ WARNING

Read this manual carefully and completely and retain for future reference. Failure to adhere to safety instructions may result in serious injury or damage.

Welcome to the world of Instant Cooking

As the new owner of an Instant™ Vortex™ 4-in-1 Air Fryer, we'd like to welcome you to the Instant Community. At Instant Brands™, we are committed to helping homechefs worldwide to cook healthier, and get delicious meals on the table, quicker and easier than ever before. Our multifunctional cooking appliances will ignite your passion for making mealtimes amazing. We have created a world of cooking resources to help you on your journey to create a variety of culinary masterpieces at home.



Join other Instant home chefs on the **Instant Pot UK community on Facebook** for tips, tricks, and inspiration from the recipes they have created.



Download the **Instant Pot app** to access 1000+ recipe ideas.



Subscribe to our e-newsletter to receive regular recipe e-books and find your next dinner favourite.



And of course, we want to hear from you, so don't forget to tag us online **@instantpotuk** and share your experiences and the dishes you create using **#InstantChefAtHome** **#instantpot**.

Say hello to the healthy and convenient alternative to deep frying. Your Air Fryer can create all your favourite fried foods with little to no oil, as well as bake delicious desserts, create perfect roasts and reheat yesterday's leftovers. If you have any comments or queries, please get in touch with us via the helpdesk on www.instantpot.co.uk/support/instant-pot-help-desk/ or by sending an email to UKSupport@instantbrands.com. You may also find the Frequently Asked Questions page on our website useful, which answers common Air Frying questions. Finally, don't forget to register your appliance online, simply head to www.instantpot.co.uk.

Product, parts and accessories

Before using your new air fryer, make sure that everything is present and accounted for.

Air fryer

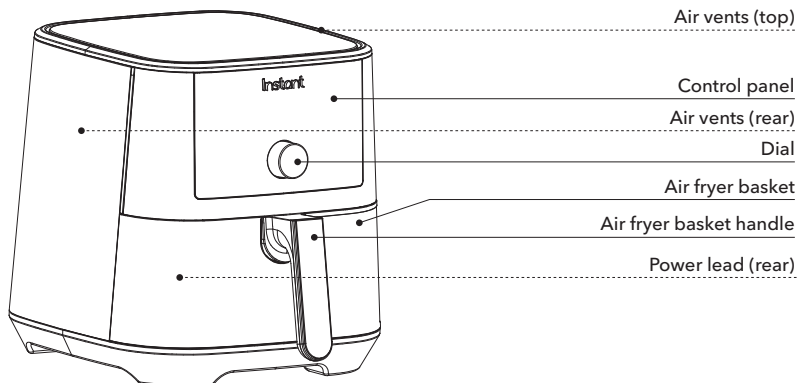

Illustrations in this document are for reference only and may differ from the actual product. Always refer to the actual product.

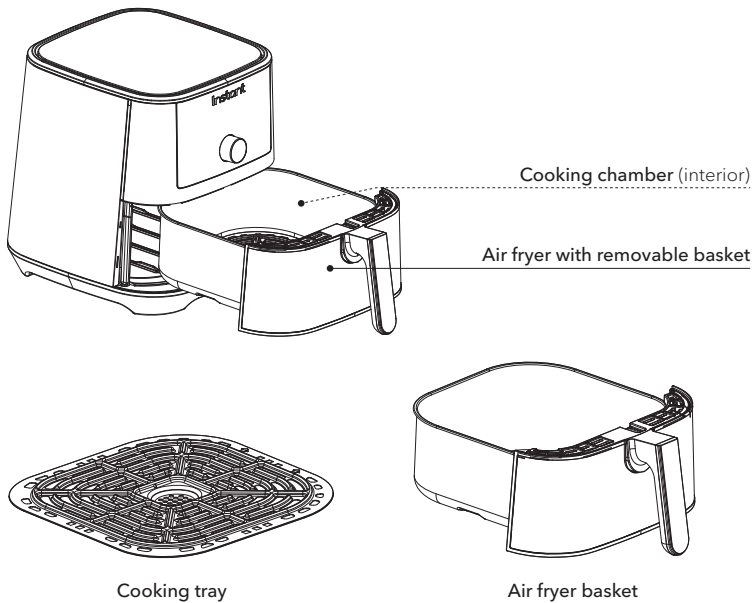

Get started



"A recipe has no soul. You as the cook must bring soul to the recipe." – Thomas Keller

Initial set up

- 01** Pull that Vortex out of the box!
 - 02** Remove the air fryer basket and check the cooking chamber for loose packing material before first use.
 - 03** You may be tempted to put the air fryer on your stovetop – *but don't do it!* Place it on a stable, level surface, *away* from combustible material and external heat sources. Do not place your air fryer on top of another appliance.
 - 04** Follow the **Care, cleaning and storage** instructions to wash your new air fryer before using it.
-  Don't remove the safety warning stickers or the rating label from the air fryer.

⚠ WARNING



<p>Read the Important Safeguards before using the appliance. Failure to read and follow those instructions for safe use may result in damage to the appliance, property damage or personal injury.</p>	<p>Do not place the appliance on a hob, on another appliance or in a heated oven. Heat from an external source will damage the appliance.</p>	<p>To avoid the risk of fire, property damage and/or personal injury, do not place anything on top of the appliance, and do not block the air vents.</p>
---	---	--

Get started



Initial test run

Take a few minutes to get to know your Instant Vortex.

Stage 1: Setting up the air fryer for cooking

- 01** Connect the power cord to a 220-240V power source.
The air fryer is in standby mode and the display shows **OFF**.
- 02** Remove the air fryer basket from the cooking chamber.
- 03** Place the cooking tray on the bottom of the air fryer basket (if it is not already installed).
 Make sure the little indicator arrows on the cooking tray point towards the back or the front of the air fryer basket.
- 04** Insert the air fryer basket back into the cooking chamber.
- 05** Touch **Air Fry**.
- 06** Touch **Temp**, then turn the dial to adjust the cooking temperature to 205°C.
 Each Smart Programme automatically saves the adjustments you make to the time and temperature when you touch **Start**.
- 07** Touch **Start** to begin!
The display shows **On** and the cooking status shows **Preheat**.
 The first few times you use your air fryer, you may notice a strong plastic smell. This is normal, non-toxic, and goes away quickly.

Stage 2: Cooking

- 01** When the air fryer is hot enough, the display shows **Add Food**.
 For this initial test, do not add food to the air fryer basket.
Carefully remove and re-insert the air fryer basket. The display shows the cooking time and temperature, and the cooking status shows **Cook**.
- 02** Part way through cooking, the display shows **turn Food**.
Wait 10 seconds for the programme to resume automatically, or, remove and re-insert the air fryer basket to pause and resume the programme manually.
- 03** When 1 minute remains, the display counts down the remaining cooking time in seconds.
When the Smart Programme completes, the display shows **End** and the fan blows for a little while to help cool the air fryer.
- 04** Touch **Cancel** to return to standby mode and start cooking for real!
 If you forget this last step, the air fryer will beep to remind you about it after 5, 30, and 60 minutes.

CAUTION

The air fryer and air fryer basket will be hot during and after cooking. To avoid the risk of burn injury, DO NOT touch hot surfaces. Allow the air fryer to cool to room temperature, then clean the appliance according to **Care, cleaning and storage** instructions.

Control panel

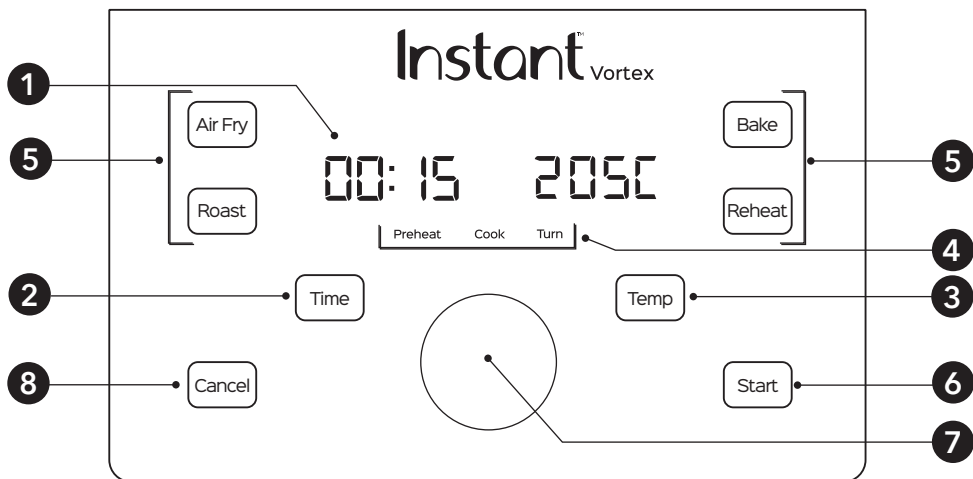

Illustrations in this document are for reference only and may differ from the actual product. Always refer to the actual product.

Is something missing or damaged?

Get in touch with a **Customer Care Advisor** by email at UKSupport@instantbrands.com or by phone on **+44 (0) 3331 230051** and we'll happily make some magic happen for you!

1	Time/temperature display	Shows the cooking time, the set temperature, reminder messages and error messages.
2	Time	Touch Time if you want to adjust the cooking time.
3	Temp	Touch Temp if you want to adjust the cooking temperature.
4	Cooking status	Preheat, Cook and Turn.
5	Smart programmes	<ul style="list-style-type: none"> • Air Fry • Roast • Bake • Reheat
6	Dial	Rotate to adjust cooking times and temperatures. Press to wake the display.
7	Start	Touch Start to begin a selected smart programme.
8	Cancel	Touch Cancel to stop a smart programme at any time and go back to standby.

Find full instructions for use online at instantpot.co.uk.

Control panel

Settings

To do this...	Do this!
Wake the air fryer.	Touch any button, press the dial, or remove and re-insert the air fryer basket to wake the air fryer. The display shows OFF to let you know that it's in standby mode and ready for action.
Turn sounds on and off.	In standby mode, touch and hold both Time and Temp for 5 seconds.  Error alerts cannot be silenced.
Change temperature scale (°C or °F).	In standby mode, touch and hold the Temp key for 5 seconds to toggle between °C and °F.
Save a custom cooking time.	Select a smart programme, then touch Time , and use the dial to adjust the time as you like. Touch Start to save the change to memory.
Save a custom cooking temperature.	Select a smart programme, then touch Temp and turn the dial to adjust the temperature as you like. Touch Start to save the change to memory.
Reset an individual smart programme.	In standby mode, touch and hold the smart programme key you want to reset (for example: Air Fry) for 5 seconds. The cooking time and temperature for that Smart Programme are restored to the factory default settings.
Reset all smart programmes.	In standby mode, press and hold the dial for 5 seconds. The cooking times and temperatures for all Smart Programmes are restored to the factory default settings.

Control panel

Cooking status

00:15 205C

Preheat

Cook

Turn

The air fryer is heating up to the perfect temperature to cook your meal.



Cooking is in progress.

Food is ready to be flipped or tossed, as required by your recipe.

 Not applicable to Reheat.

 Only applicable to Air Fry and Roast.

Status messages

OFF	The air fryer is in standby mode.
On	A smart programme is in the Preheat stage.  Not applicable to Reheat.
Add Food	This message appears to let you know that the air fryer has reached the perfect cooking temperature and food can be added to the air fryer basket (if it hasn't been already).  Not applicable to Reheat.
00:15	The display shows the cooking time and on-screen messages.
205C	The display also shows the set cooking temperature and on-screen messages.
Turn Food	Food is ready to be turned or tossed, as recommended by your recipe.  Only applicable to Air Fry and Roast.
End	The Smart Programme has finished.

Cooking

Cooking in the Vortex is quick and easy – food goes in, crispy deliciousness comes out!

Check out the **cooking timetables** for guidance or visit our **recipe site** at instantbrands.co.uk for fun, easy-to-follow recipe instructions. You can also download the free **Instant Pot app** to search recipes, save favourites, make notes and more!

Air Fry, Roast and Bake

These programmes give your meals all the rich, crispy flavour of deep frying with little to no oil, so you can say, “See ya!” to the greasy mess and extra calories! The pre-sets are a starting point that you can experiment with to get the results you prefer.

Smart programme	Model	Default time	Time range	Default temperature	Temperature range
Air Fry	Vortex 4	17 minutes (00:17)	1 minute to 1 hour (00:01 to 01:00)	205°C	82 to 205°C
	Vortex 6	15 minutes (00:15)	1 minute to 1 hour (00:01 to 01:00)	196°C	82 to 205°C
Roast	Vortex 4	18 minutes (00:18)	1 minute to 1 hour (00:01 to 01:00)	205°C	82 to 205°C
	Vortex 6	18 minutes (00:18)	1 minute to 1 hour (00:01 to 01:00)	193°C	82 to 205°C
Bake	Vortex 4	22 minutes (00:22)	1 minute to 1 hour (00:01 to 01:00)	176°C	82 to 205°C
	Vortex 6	30 minutes (00:30)	1 minute to 1 hour (00:01 to 01:00)	185°C	82 to 205°C

Stage 1: Setting up for cooking

- 01** Follow steps 01 to 04 in the **Initial test run: Stage 1** to set up the air fryer.
- 02** Touch the smart programme you want to use: **Air Fry, Roast** or **Bake**.
- 03** Touch **Temp**, then turn the dial to adjust the temperature.

- 04** Touch **Time**, then turn the dial to adjust the time.

 Smart Programmes automatically save adjustments to temperature and time settings when you touch **Start**.

- 05** Touch **Start** to begin!

The display shows **On** and the cooking status shows **Preheat**.

Cooking

Stage 2: Cooking

01 When the display shows **Add Food**, remove the air fryer basket and carefully place your food items inside the hot cooking chamber.

 You can put food directly on the cooking tray or in any oven-safe baking dish.

02 Carefully re-insert the air fryer basket. The display shows the cooking time and temperature, and the cooking status shows **Cook**.

03 Part-way through cooking, the display shows **turn Food**.

 Not applicable to Bake.

If you want to toss or turn your food, remove the air fryer basket and do so, then re-insert the basket into the air fryer. Cooking pauses and resumes automatically.

 If your food does not need to be flipped, wait 10 seconds for the programme to resume automatically.

04 When the display shows **End**, carefully remove your food from the hot cooking chamber.

CAUTION

The air fryer oven and air frying accessories will be hot during and after cooking. Do not touch hot surfaces with unprotected hands. Allow all items to cool to room temperature, then clean them according to **Care, cleaning and storage** instructions.

To avoid a burn injury, always use proper hand protection and exercise extreme caution when adding food to or removing it from the hot cooking chamber.

Cooking

Cooking tips

Give all your favourite fresh and frozen oven-baked and deep-fried snacks a fighting chance!

- Preheating is an important step! Wait for the **Add Food** message to appear before adding food to the air fryer basket.
- When baking muffins, buns, quiche and other treats, cover your oven-safe baking dish to prevent the top from overcooking.
- For coated food, like onion rings or deep-fried snacks, use an egg wash with breadcrumbs rather than liquid-based batters to make sure the batter sticks to the food.
- Spray food items with cooking oil *before* adding seasoning so that the seasoning sticks well.
- For super crispy chips, soak your fresh-cut potato sticks in iced water for 15 minutes, then pat them dry and spray lightly with oil before cooking.
- Patting dry moist food items before cooking prevents excess steam and splatter and gives you crispier results.
- Air frying can cause oil and fat to drip from foods. To prevent excess smoke, carefully remove and drain the air fryer basket as needed.

Check out the **cooking timetables**, download the **Instant Pot app** or visit our **recipe site** for fun, easy-to-follow recipes.

CAUTION

To avoid the risk of fire, property damage and personal injury, **DO NOT** spray cooking oil into the cooking chamber

Cooking

Reheat

Smart programme	Model	Default time	Time range	Default temperature	Temperature range
Reheat	Vortex 4	10 minutes (00:10)	1 minute to 1 hour (00:01 to 01:00)	138°C	49 to 182°C
	Vortex 6	10 minutes (00:10)	1 minute to 1 hour (00:01 to 01:00)	138°C	49 to 182°C

- 01 Follow steps 01 to 04 in the **Initial test run: Stage 1** to set up the air fryer.
- 02 Remove the air fryer basket and place your food items inside, then carefully re-insert it.
- 03 Touch **Reheat**.
- 04 Touch **Temp**, then turn the dial to adjust the temperature.
- 05 Touch **Time**, then turn the dial to adjust the time.
 Smart Programmes automatically save adjustments to temperature and time settings when you touch **Start**.
- 06 Touch **Start** to begin heating.
The time starts counting down straight away.
- 07 When the display shows **End**, carefully remove your food from the hot cooking chamber.

CAUTION

The air fryer oven and air frying accessories will be hot during and after cooking. Do not touch hot surfaces with unprotected hands. Allow all items to cool to room temperature, then clean them according to **Care, cleaning and storage** instructions.

To avoid a burn injury, always use proper hand protection and exercise extreme caution when adding food to or removing it from the hot cooking chamber.

Care, cleaning and storage

Clean your air fryer and accessories after each use.

Always unplug the air fryer and let it cool to room temperature before cleaning. Never use harsh chemical detergents, scouring pads, or powders on any of the parts or components.

Let all surfaces dry thoroughly before use, and before storage.

Part or accessory	Cleaning method and notes
Air fryer basket	<ul style="list-style-type: none">• Clean the air fryer basket with a sponge or cloth and warm water and dish soap, then rinse well. Ensure that all grease and food debris are removed.• DO NOT immerse the basket in water or any other liquid.• DO NOT machine wash the basket.
Cooking tray	<ul style="list-style-type: none">• Clean the cooking tray with a cloth or sponge and warm water and dish soap.• The cooking tray has non-stick coating. To avoid damage to the non-stick coating, DO NOT use metal cleaning utensils.
Cooking chamber	<ul style="list-style-type: none">• Clean the cooking chamber with a sponge or soft cloth and warm water and dish soap.• To remove baked-on grease and food residue from cooking chamber, spray with a mixture of baking soda and vinegar and wipe clean with damp cloth.• For stubborn stains, allow the mixture to sit on the affected area for several minutes before scrubbing clean.• Check the heating coil for oil spatter and food debris. Clean the heating coil with a damp cloth as needed. Ensure the heating coil is completely dry before next use.
Exterior	<ul style="list-style-type: none">• Clean with a soft, damp cloth or sponge and wipe dry.

Any other servicing must be performed by an authorized representative.

WARNING

To avoid risk of electric shock and personal injury:

- Do not immerse the appliance in water.
- Do not rinse the appliance under a tap.
- Do not wet the pins of the power lead.

Without proper cleaning, food and grease splatter may build up around the heating element, causing the risk of smoke, fire and personal injury.

If you see or smell smoke, touch **Cancel**, unplug the appliance and allow it to cool. Remove food splatter or grease with a soft cloth and a mild detergent.

Troubleshooting

Register your air fryer today!

If your problem persists or if you have questions, get in touch with a Customer Care

Advisor by email at EUsupport@instantbrands.co.uk or by phone on **+44 (0) 3331 230051**

Problem		Possible reason	Solution
Black smoke is coming from the air fryer.	⚠ CAUTION Stop cooking immediately. Cancel the Smart Programme, then unplug the air fryer and allow it to cool to room temperature.		
	Using an oil with a low smoke point.	Touch Cancel , unplug the air fryer and allow it to cool to room temperature. Choose a neutral oil with a high smoke point, such as avocado, canola, soybean, safflower or rice bran.	
	Food residue on the heating coil, in the cooking chamber or on accessories.	Touch Cancel , unplug the air fryer and allow it to cool to room temperature. Clean the cooking chamber and accessories thoroughly.	
	Faulty circuit or heating element.	Touch Cancel , unplug the air fryer and allow it to cool to room temperature. Contact Customer Care .  Do not attempt to repair the appliance.	
White smoke is coming from the air fryer.	Cooking foods with a high fat content, such as bacon, sausages and hamburgers.	Avoid air frying foods with a high fat content. Check the air fryer basket for excess oil or fat and carefully remove as needed after cooking.	
	Water is evaporating, producing thick steam.	Pat dry moist food ingredients before air frying and do not add water or other liquids to the cooking chamber when air frying.	
	Seasoning on food has blown into the element.	Be careful when seasoning food. Spray vegetables and meats with oil before seasoning to help the seasoning stick.	
The air fryer is plugged in but will not turn on.	The appliance is not properly plugged in.	Make sure the power lead is in good condition and is plugged firmly into the socket.	
	Power is not switched on at the socket.	Plug another appliance into the same socket to see if it works. Move the air fryer to another socket.	
	Air fryer basket is not fully inserted into the cooking chamber.	Make sure the air fryer basket is fully inserted into the cooking chamber.	
All lights flash and a code appears on the display.	E1	Temperature sensor circuit broken.	Contact Customer Care .
	E2	Temperature sensor short circuit.	Contact Customer Care .

Any other servicing must be performed by an authorised representative.

Warranty

Limited Warranty

Instant Brands (EMEA) Limited and Instant Brands Inc. (collectively the "Company") warrant this appliance to be free from defects in workmanship and material, under normal household use, for a period of one (1) year from the date of original purchase. This Limited Warranty extends only to the original purchaser and use of the appliance in the UK. This warranty does not cover appliance use outside of the UK.

Proof of original purchase date and, if requested, return of your appliance is required to obtain service under this Limited Warranty. Provided that this appliance is operated and maintained in accordance with the written instructions included with the appliance (which are also available at instantpot.co.uk), the Company will, at its sole discretion, either: (i) repair defects in materials and workmanship; or (ii) replace the appliance. In the event the appliance is replaced, the Limited Warranty on the replacement appliance will expire 12 months from the date of original consumer purchase.

The Company is not responsible for shipping costs for warranty service.

Limitation and Exclusions

Any modification or attempted modification to your appliance may interfere with the safe operation of the appliance and may result in serious injury and damage. Any modification or attempted modification to your appliance or any part thereof will void the warranty, unless such modification(s) or alteration(s) were expressly authorised by the Company.

This warranty does not cover (1) normal wear and tear; (2) damage resulting from negligent, unreasonable or misuse of the appliance, improper assembly or disassembly, use contrary to the operating instructions, failure to provide reasonable and necessary maintenance, Acts of God (such as fire, flood, hurricanes and tornadoes), or repair or alteration by anyone, unless expressly directed and authorised by the Company; and (3) repairs where your appliance is used for other than normal household use and in a manner contrary to published user or operator instructions.

To the extent permitted by applicable law, the liability of the Company, if any, for any allegedly defective appliance or part shall be limited to repair or replacement of the appliance or part thereof, and shall not exceed the purchase price of a comparable replacement appliance. Except as expressly provided herein and to the extent permitted by law, (1) the Company makes no warranties, conditions or representations, express or implied, usage, custom of trade or otherwise with respect to the appliance or parts covered by this warranty and (2) the Company shall not be responsible or liable for indirect, incidental or consequential damages arising out of or in connection with the use or performance of the appliance or damages with respect to any economic loss, loss of property, loss of revenues or profits, loss of enjoyment or use, costs of removal, installation or other consequential damages of any nature or kind.

You may have rights and remedies under applicable laws, which are in addition to any right or remedy which may be available under this limited warranty.

Warranty

Warranty Registration

Please visit instantpot.co.uk/support/register to register your appliance. You will be asked to provide your name, your email address, the store name, date of purchase, model number and serial number (both of which are found on the appliance). This registration will enable us to keep you up-to-date with product developments and recipes, and contact you in the unlikely event of a product safety notification. By registering, you acknowledge that you have read and understood the instructions for use and warnings accompanying the appliance.

Warranty Service

- Your name, email address or phone number.
- A copy of the original purchase receipt with order number, model and serial number.
- A description of the product defect, including any photographs or video if possible.

Warranty Registration

Instant Brands (EMEA) Limited
1 Christchurch Way
Woking
Surrey. GU21 6JG, UK

Email: UKSupport@instantbrands.com

Telephone: +44 (0) 3331 230051

This warranty was last updated on 1 September 2019 for all products sold from [1 November 2019]. If your product comes with our older warranty version, your warranty will continue to be honoured.

Recycling

This appliance complies with the WEEE Directive 2012/19/EU on the disposal of electrical and electronic equipment (WEEE). This appliance complies with the European directive for electromagnetic compatibility (EMC) 2014/30/EU and its revisions, as well as Low Voltage Directive (LVD) 2014/35/EU and its revisions.

This marking indicates that this product should not be disposed of with other household waste throughout the United Kingdom. To prevent possible harm to the environment or human health from uncontrolled waste disposal, recycle it responsibly to promote the sustainable re-use of material sources. To return your used device, please use the return and collection systems or contact Customer Care for further recycling and WEEE information.



Inst nt™

Instant Brands Inc.

Instant Brands (EMEA) Limited,
1 Christchurch Way,
Woking, Surrey,
GU21 6JG, UK.

Register your product today

www.instantpot.co.uk/support/register

Subscribe to our newsletter

Contact us

+44 (0) 3331 230051

UKSupport@instantbrands.com
instantpot.co.uk

Join the Official Instant Pot Community

www.facebook.com/groups/InstantPotUKCommunity

Download Free App



Tag us in your creations

 @instantpotUK

 @InstantpotUK

 @instantpotUK

 @InstantpotUK

 @InstantBrandsUK

Made in China

Copyright © 2021 Instant Brands™ Inc
885-0319-91