

# USER MANUAL

## NMS20 - NMS30 Hand Held Metal Detector



**Nokta | MAKRO**  
DETECTION TECHNOLOGIES



# INTRODUCTION

Thank you for choosing and purchasing the NMS20/NMS30 Hand Held Metal Detector.

NMS20/NMS30 is a hand-held metal detector designed to find all kinds of ferrous and non-ferrous metals carried on a person or inside a non-metal object.

## WARNINGS!

- ▶ NMS20/30 is a state-of-the-art electronic device. Do not operate the device before reading the user manual.
- ▶ Do not store the device under extremely low or high temperatures for extended periods. (Storage Temperature: - 40°C to 80°C / - 40°F to 185°F)
- ▶ The device is waterproof up to 1 meter (3ft.) and thus is protected for use in the rain and against liquid spills (does not apply to the versions with earphone jack).
- ▶ Wipe the device with a damp, soft, non-scratch cloth. Do not use any cleaning products that contain chemicals!
- ▶ Always keep the device off when not in use. This will help increase battery life.
- ▶ Protect the detector against impacts during normal use. For shipping, carefully place detector in original carton and secure with shock resistant packaging.
- ▶ NMS20/30 metal detector may only be disassembled and repaired by **Nokta Makro Authorized Service Centers**. Unauthorized disassembly/intrusion into the metal detector control housing for any reason voids the warranty.
- ▶ Remove the batteries when the unit will not be used for extended periods of time in order to avoid damage to the thermometer resulting from battery leakage, heat generation or bursting.
- ▶ It is the operator's responsibility to set the appropriate level of security/sensitivity for his/her application. In addition, it is also the operator's responsibility to calibrate the device using test pieces appropriate for the security/sensitivity level selected.

Nokta Makro is not responsible for any direct or indirect harm caused by the misuse of the device.



For Consumers within the European Union: Do not dispose of this equipment in general household waste. The crossed wheeled bin symbol on this equipment indicates this unit should not be disposed of in general household waste, but recycled in compliance with local government regulations and environmental requirements.



## FCC STATEMENT

This device complies with Part 15 of the FCC Rules. Operation is subject to the following two conditions: (1) this device may not cause harmful interference, and (2) this device must accept any interference received, including interference that may cause undesired operation.

# TABLE OF CONTENTS

<b>INTRODUCTION TO THE DEVICE</b> .....	1-2
Package Contents.....	1
Optional Accessories.....	1
Controls and Indicators.....	2
<b>BATTERY INFORMATION</b> .....	3-5
Battery Life Indicator.....	3
Charging the Batteries.....	3-4
Connecting Multiple Charging Stations.....	4-5
<b>DEVICE OPERATION</b> .....	6-11
Turning On the Device.....	6
Resetting the Alarm.....	6
Sensitivity Setting.....	6
Alarm Selection.....	6
Scanning.....	7
Metal Detection.....	7
Auto Stand-By Mode.....	8
Turning Off the Device.....	8
Changing the Frequency.....	8
Testing the Device.....	8-9
Using Multiple Detectors Simultaneously.....	9
Using the Device Next To Walk-Through Metal Detectors.....	9
<b>TROUBLESHOOTING</b> .....	10
<b>TECHNICAL SPECIFICATIONS</b> .....	11

---

---

# INTRODUCTION TO THE DEVICE

## Package Contents

- (1) NMS20/30 Hand Held Metal Detector
- (2) NMS20/30 Charging Station
- (3) USB Charging Cable
- (4) NMS20/30 Charging Station Connection Pins (3 pieces)
- (5) Calibration Test Piece
- (6) 2xAA Batteries
- (7) Universal Charging Adaptor
- (8) Universal Charging Adaptor Plugs
- (9) Wrist Strap
- (10) Belt Holster

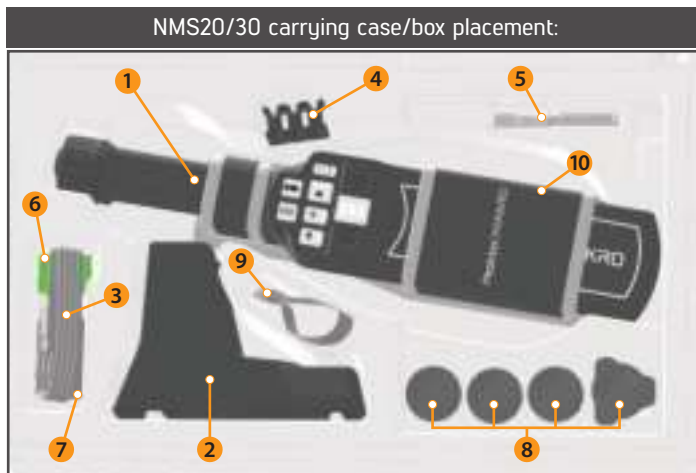

## Optional Accessories

Below are the optional accessories you can purchase separately and that are not supplied with the device:



NMS20/30 Carrying Case



NMS20/30 Multi-Docking Station

# INTRODUCTION TO THE DEVICE

## Controls and Indicators

- (1) Handle
- (2) Detection Sensor
- (3) On/Off & Reset Button
- (4) LED Alarm Indicator
- (5) Battery Life Indicator
- (6) Sensitivity Setting Button & Indicator
- (7) Audio Alarm Button
- (8) Vibration Alarm Button
- (9) Buzzer
- (10) Rebar Elimination Button
- (11) Battery Compartment Cover
- (12) Wrist Strap Hole

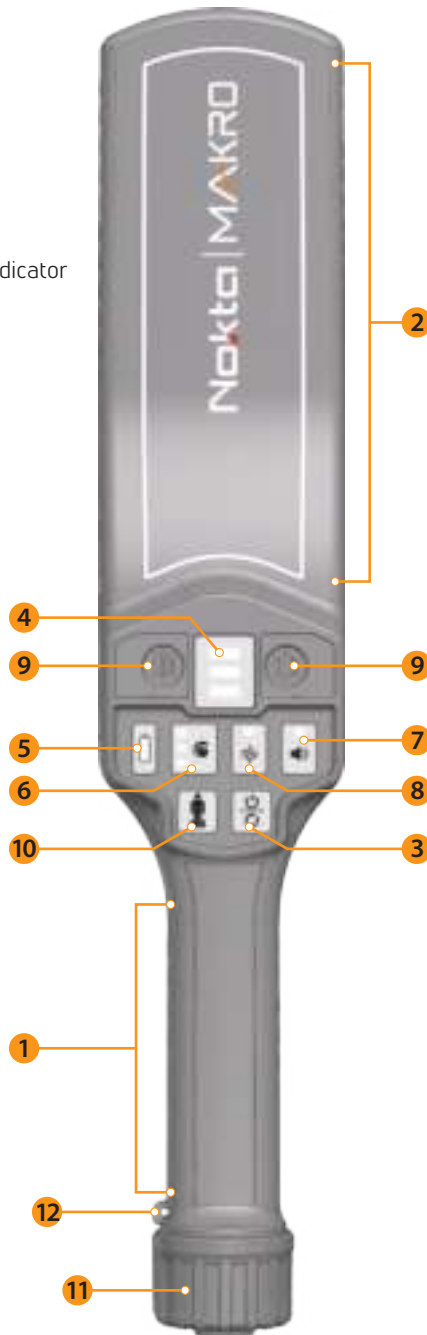

# BATTERY INFORMATION

The device is supplied with 2 rechargeable 2700 mAh Ni-MH batteries.

To insert the batteries, first remove the screw on the battery compartment cover. Then, give the battery compartment cover a quarter turn counter-clockwise and remove both the cover and the battery stopper underneath.

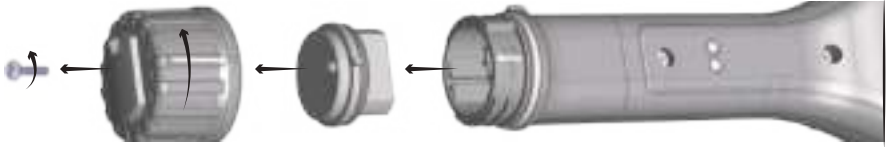

Insert the batteries paying attention to (+) and (-) polarity. Then, insert the battery stopper in the correct direction. Next, attach the battery compartment cover with the white lines on the cover and on the device aligned. Then, give the battery compartment cover a quarter turn clockwise and tighten. Lastly, tighten the screw.

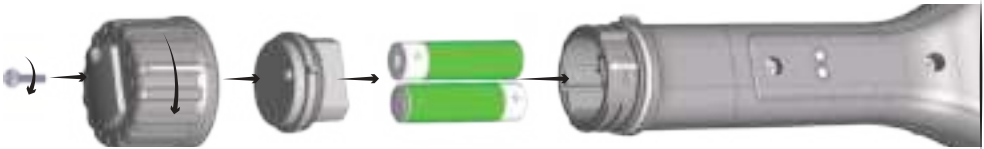

## Battery Life Indicator

The LED on the battery life indicator shows the battery life in 3 different colors:



## Charging the Batteries

Insert the B-type end of the USB charging cable to the charging station. Then, plug the charging adaptor into a wall outlet. Place the detector in the charging station. Charging will start automatically.



# BATTERY INFORMATION



While charging, the LED on the battery life indicator will blink in red. When charging is completed (maximum 4 hours) the LED on the battery indicator will light up solid green.

It is normal for the charging adaptor and the battery compartment to heat up during charging.

There is no harm in leaving the device in the charging station once it is fully charged or removing it from the charging station and using it without waiting for full charge.

**WARNING!** Keep the battery charging pins located on the device and the charging station clean to ensure proper electrical contact.

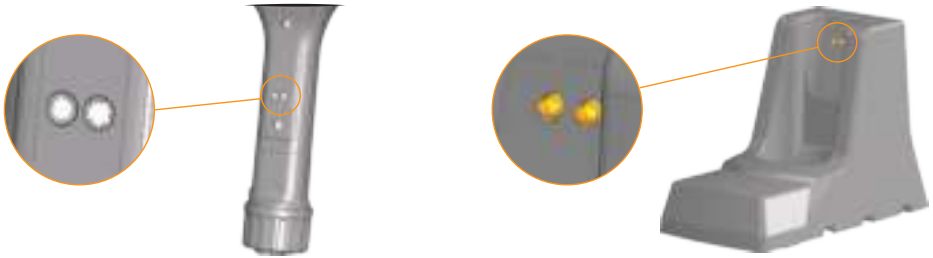

**NOTE:** If the rechargeable Ni-MH batteries are not used for a long time, they may not be charged again. Therefore, we recommend you to charge them once a month even if you are not going to use them.

## Connecting Multiple Charging Stations

When charging multiple devices, you may connect the charging stations together.

For NMS20:

1. Insert the 3 charging station connection pins supplied with the device on one station as shown in the below picture.
2. Align the other station with the pins and slide it down to snap it into its place.

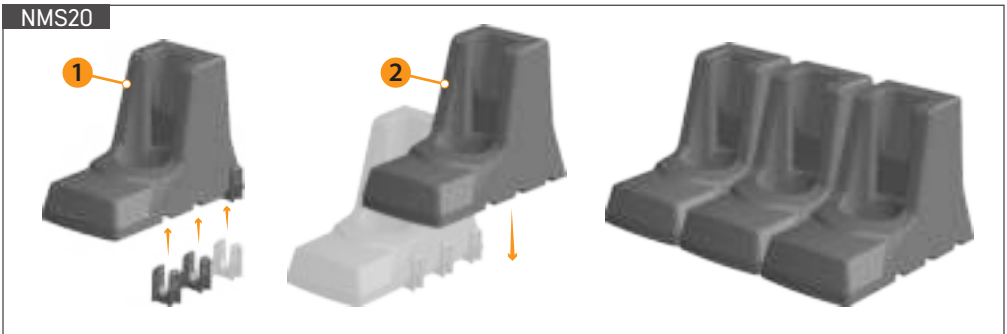



# BATTERY INFORMATION

For NMS30:

In NMS30, 2 pins are used instead of 3. When connecting 2 charging stations for this model, insert the first pin in the middle slot and the second pin in the back slot of the first station leaving the first slot empty. If you want to connect a third station, insert the first pin in the middle slot again but this time, insert the second pin in the front slot of the second station leaving the back slot empty as shown in the picture. When connecting more stations follow the same pattern with the middle slot being the constant.

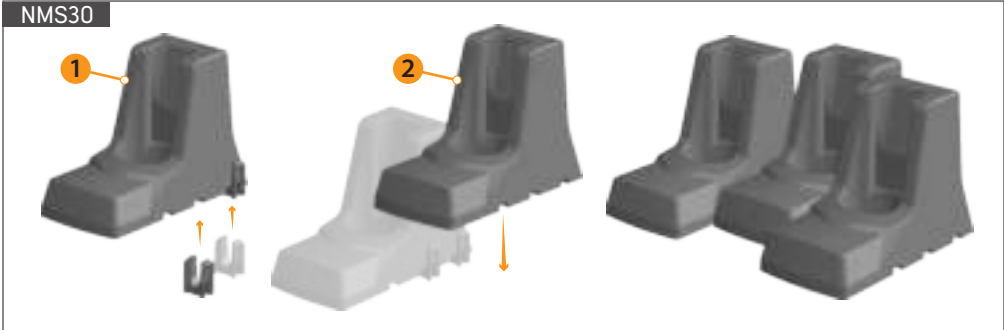

# DEVICE OPERATION



## Turning On the Device

Press and hold the on/off button for 1.5 seconds. The LEDs will blink. After a long and a short beep, battery life and sensitivity indicator LEDs as well as the alarm button LEDs (if they are activated) will stay lit up. The device is ready for use.

**WARNING!!** Keep the device away from metal objects when turning it on.

**NOTE:** In case the device emits a continuous alarm, press the on/off button once to reset it.



## Resetting the Alarm

If the device starts emitting an alarm without the presence of a metal object, press the on/off button once to reset the alarm.



## Sensitivity Setting

The sensitivity setting consists of 3 levels:

Each time you press the sensitivity button the level changes and the white LEDs indicate the sensitivity level.



1 White LED:  
Low Sensitivity



2 White LEDs:  
Medium Sensitivity



3 White LEDs:  
High Sensitivity

Sensitivity setting should be adjusted according to the target metal size and maximum operating distance.

Large Metal Objects: Low Sensitivity Setting

Medium Size Metal Objects: Medium Sensitivity Setting

Small Metal Objects: High Sensitivity Setting

For metal sizes, NIJ Standard – 0602.02 has been taken as a reference.

## Alarm Selection



### Audio Alarm

You can activate the audio alarm by pressing the audio alarm button once. The LED on the button will light up solid. To turn off the alarm press the button again. The LED will go off.



### Vibration Alarm

You can activate the audio alarm by pressing the vibration alarm button once. The LED on the button will light up solid. To turn off the alarm press the button again. The LED will go off.

**NOTE:** The audio and vibration alarms can be activated separately or at the same time or they can both be turned off to have a silent operation.

# DEVICE OPERATION

## Scanning





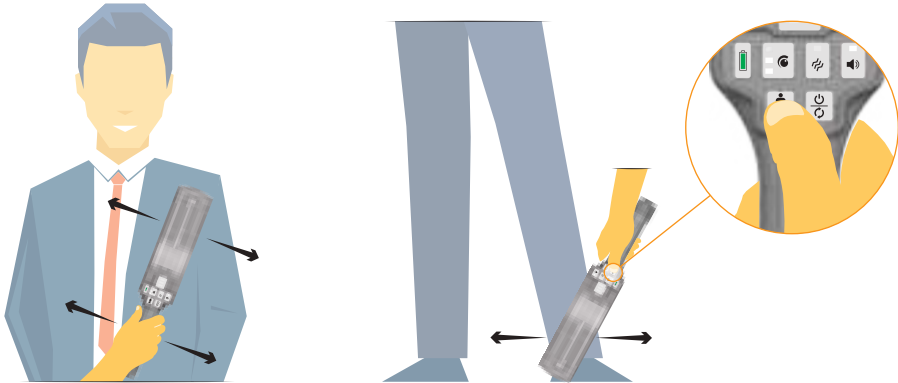

Scan the person's body by holding the device close to the area being scanned.

**WARNING!** When scanning areas closer to the ground, to eliminate the detection of rebar, keeping the rebar elimination button held down, hold the detector as shown in the picture and scan vertically.



## Metal Detection

When the device detects a metal target, the LED Alarm Indicator will light up as follows in proportion to the size and proximity of the target:

	All 3 LEDs are off: No metal target		1 Green LED: Small metal		1 Green LED + 1 Yellow LED: Medium-sized metal
	1 Green LED + 1 Yellow LED + 1 Red LED: Large metal		3 Red LEDs: Very Large Metal		Blue LED(s): Please read the note section below!

When metal is detected, if the audio alarm is active, the device will emit an audio warning. The tone of the audio alarm is proportional to the size (small/medium/large) or the proximity of the metal target.

**NOTE:** In the NMS20R and NMS30R models that have radiation detection, when Beta ve Gamma radiation is detected, beeps will be emitted in frequency that is proportional to the amount of radiation and the blue LEDs will flash on the LED Alarm Indicator.

# DEVICE OPERATION

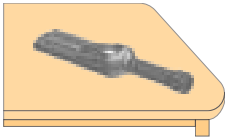

## Auto Stand-By Mode

When the device is laid down flat on a surface with the indicators facing up, it will go into an auto stand-by mode after 180 seconds to reduce power consumption.



When the device is laid down flat on a surface that contains metal with the indicators facing up, it will go into an auto stand-by mode right after emitting an alarm for a second.

To get the device out of the stand-by mode, just move it.

## Turning Off the Device

The device shuts down in 2 ways:

### Auto Shut-Down

The device will shut down after 35 minutes of being in stand-by mode and will not start if you move it. You need to press and hold the on/off button for 1.5 seconds to turn it on.



### Manual Shut-Down

Press and hold the on/off button for at least 3 seconds. The LEDs will blink and the device will shut down.



### Changing the Frequency

While the device is off, turn it on while keeping the rebar elimination button pressed. The device will emit 1-5 beeps. Each different number of beeps indicate a different frequency. To change the frequency, turn the device off and turn it on again while pressing the rebar elimination button pressed.

## Testing the Device

The test piece supplied with the device enables the user to test whether the device is working correctly or not.

Follow the below steps to perform a test:

1) Set the sensitivity setting to maximum - level 3. Then, hold the test piece so that the 3 lines are at the **bottom**. When testing the NMS20, hold the test piece approximately 2" below the top of the device and sweep it across the device by lightly touching it. When testing the NMS30, hold the test piece at the center of the device and sweep it across the device by lightly touching it. The device must generate an alarm.

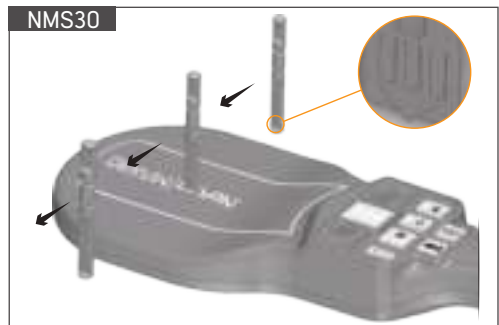
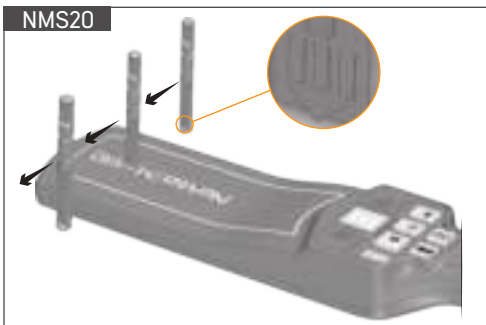

# DEVICE OPERATION

2) Set the sensitivity setting to minimum – level 1. Then, hold the test piece so that the 3 lines are at the top and repeat the process above. The device must generate an alarm.

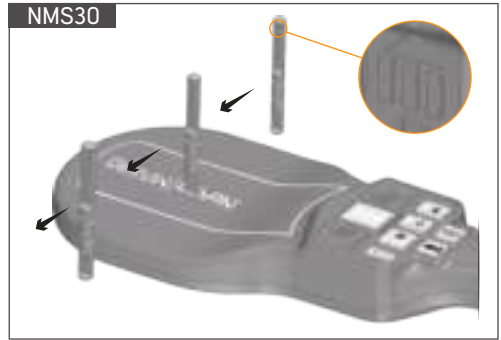
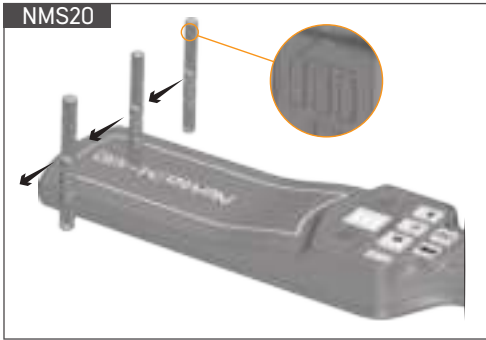

## Using Multiple Detectors Simultaneously

While using multiple detectors simultaneously, the devices must be kept 1 meter (3.3 ft.) away from each other. This distance may vary based on the operating frequency.

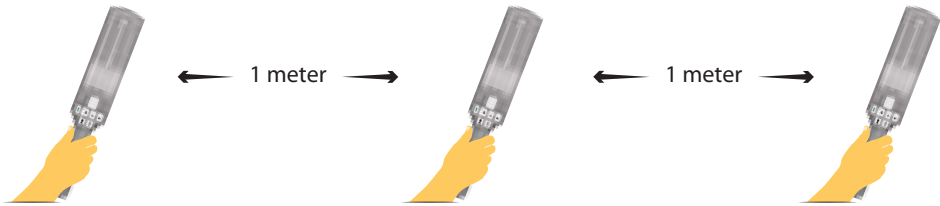

## Using the Device Next To Walk-Through Metal Detectors

Hand-held metal detectors can be used close to walk-through metal detectors at a distance usually designated for secondary inspections.

# TROUBLESHOOTING

**Issue:** The device is emitting an alarm without the presence of a metal target.

**Possible Cause:** Electromagnetic sources are present nearby.

1) Another hand-held detector operating at the same frequency

**Solution:** Turn the detector off and change the frequency.

2) A walk-through metal detector or another electromagnetic noise source

**Solution:** Increase your distance with the source of the electromagnetic interference.

**Issue:** Battery is not charging.

**Possible Causes:** Wrong procedure, battery charging pins are dirty or the batteries are not inserted correctly or they are depleted.

**Solution:**

1) Remove the detector from the charging station and make sure it is off.

2) Make sure that the charging station is connected to the adaptor and the AC power is available.

3) Re-insert the detector in the charging station.

4) Make sure that the charging pins on the detector and station are clean and working properly.

5) Make sure that the batteries are rechargeable and inserted correctly.

6) Change the charging station.

**If the issue persists, contact your dealer or technical service.**

**Issue:** Device test failed.

**Possible Causes:** Wrong procedure.

**Solution:** Turn the detector on again and repeat the procedure. If the issue persists, contact your dealer or technical service.

**Issue:** The device emits 4 beeps at start up and shuts down.

**Solution:** There is an issue with the circuit, contact your dealer or technical service.

# TECHNICAL SPECIFICATIONS

Operating Frequency:	: 13 kHz
Power Supply	: Metal Detector: 2xAA Ni-MH 2700 mAh rechargeable batteries AC/DC Charging Adaptor: 100-240Vac 50-60Hz 0.5A
LED Alarm	: Yes
Audio Alarm	: Yes
Vibration	: Yes
Sensitivity	: 3 levels
Rebar Elimination	: Yes
Battery Life	: 40+ hours
Operating Temperature	: Metal Detector: -40°C - 70°C (-40°F - 158°F) Charging Station: 0°C - 70°C (32°F - 158°F)
Storage Temperature	: -40°C - 85°C (-40°F - 185°F)
Dimensions (WxLxH)	: NMS20: 82x445x48mm (3.2"X17.0"X1.9") NMS30: 128x405x48mm (5.0"X15.9"X1.9") Charging Station: 85x180x128mm (3.3"X7.1"X5.0") Optional NMS20/30 Multi Docking Station: 247x615x82mm (9.7"X24.2"X3.3") Optional NMS20/30 Carrying Case: 300x510x110mm (11.8"X20.1"X4.3")
Weight	: NMS20: 605g. (1.3lbs) NMS30: 610g. (1.3lbs) Charging Station: 625g. (1.4lbs) Optional NMS20/30 Multi Docking Station: 2595g. (5.7lbs) Optional NMS20/30 Carrying Case: 1325g. (2.9lbs)

**Nokta | MAKRO**  
DETECTION TECHNOLOGIES  
[www.noktadetectors.com](http://www.noktadetectors.com)