

Model 203-I
213-F

The logo for Aynna, featuring the brand name in a stylized, orange, cursive font. The letters are contained within a horizontal orange bar that has rounded ends and a slight shadow effect.

Aynna









A large, light gray silhouette of a person performing a handstand on a trampoline. The person's legs are raised and bent at the knees, and their arms are extended downwards. The trampoline's springs are visible at the base of the person's feet.





Rectangular trampolines

Assembly manual

Model 203-I



| Model 203-I 215x155 cm | | | |
|--------------------------------------|----------|---|---|
| | Quantity | Part number | |
| Jumping mat | 1 | TEPL-203-222 |  |
| Galvanized spring L=175mm, ø3.2mm | 44 | TEPL-200-211/C |  |
| Safety pad | 1 | TEPL-203-333-I-green or AVGR-203-333-I-grey of CAM-203-333-I-camouflage |  |
| Fastener for Safety pad | 8 | TEPL-ELAS-A |  |
| L-tube | 2 | TEPL-203-I-1131 |  |
| L-tube | 2 | TEPL-203-I-1132 |  |
| K-tube | 2 | TEPL-203-I-1141 |  |
| K-tube | 2 | TEPL-203-I-1142 |  |
| H-tube | 2 | TEPL-203-I-1151 |  |
| H-tube | 2 | TEPL-203-I-1152 |  |

| Model 203-I 215x155 cm | | | |
|--------------------------------|----------|-------------|---|
| | Quantity | Part number | |
| Inground pin | 8 | TEPL-PIN |  |
| Inground pin for safety pad | 8 | TEPL-SP-PIN |  |
| Tool for spring | 1 | TOOL-SPRING |  |
| Fastener for Safety pad | 16 | TEPL-ELAS-B |  |
| Users manual | 1 | 208010101 | |
| Warning Card | 1 | 208040101 | |
| Tie rip for warning card | 1 | 209010102 | |
| Safety manual | 1 | 208010301 | |

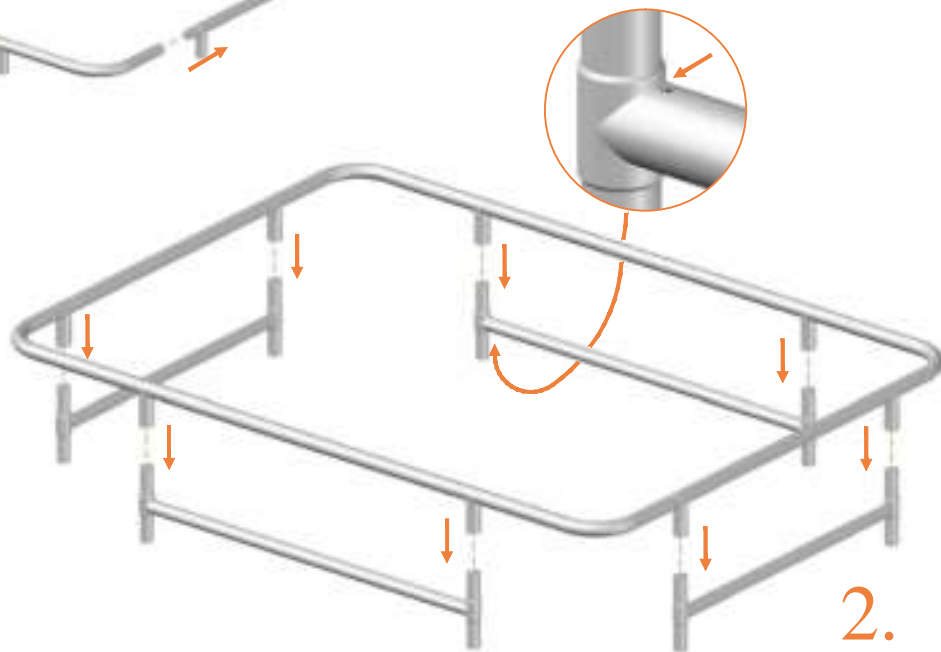
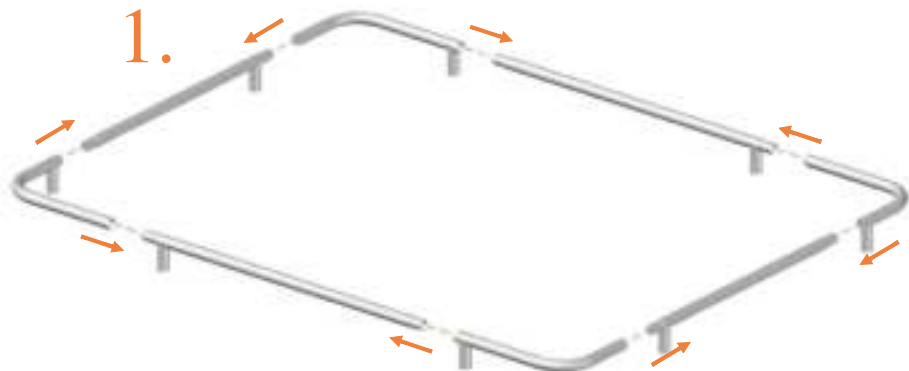

3.

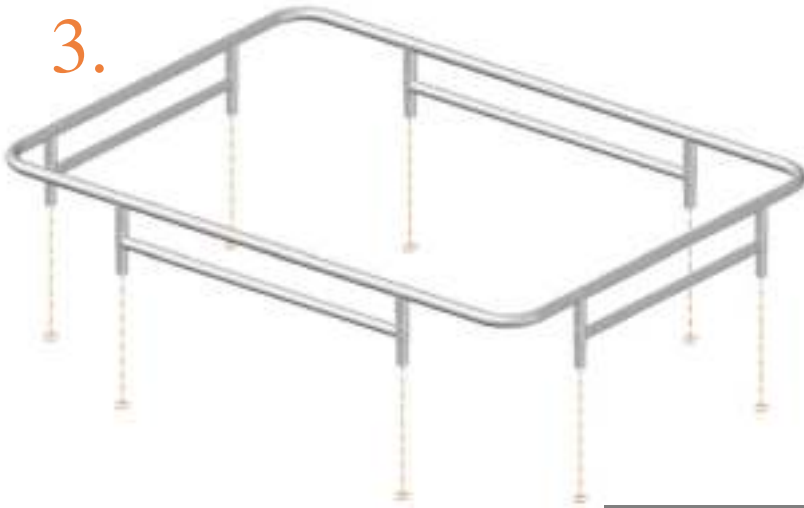

Rubber hammer!



4.

5.

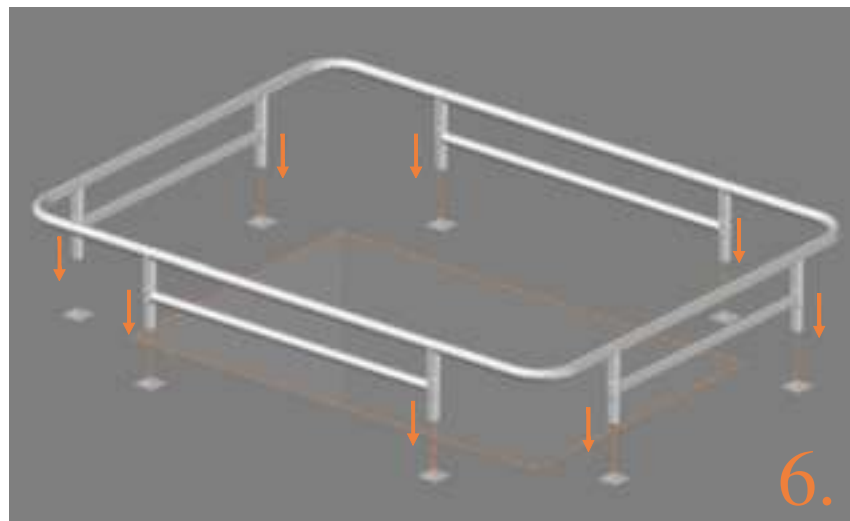
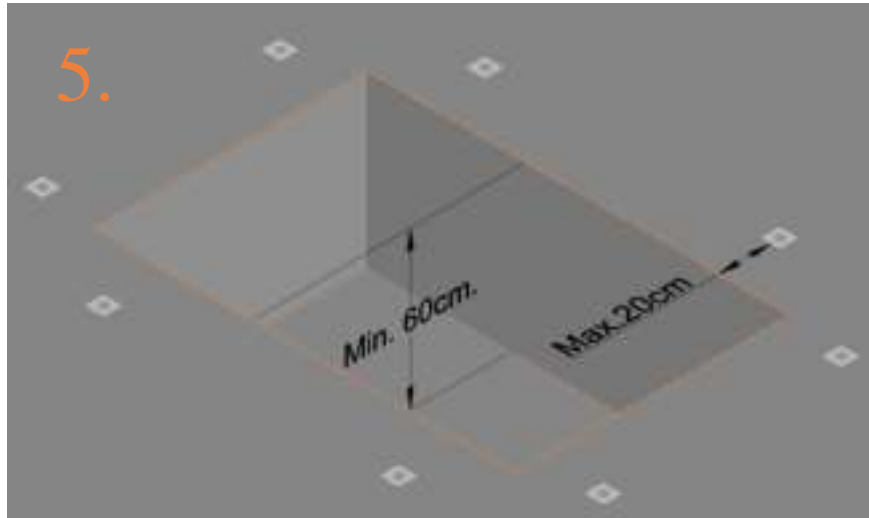

6.

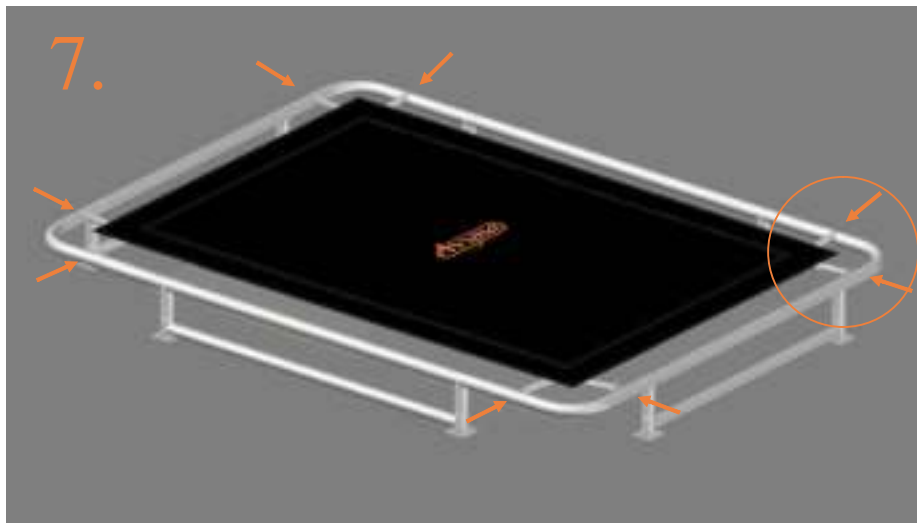

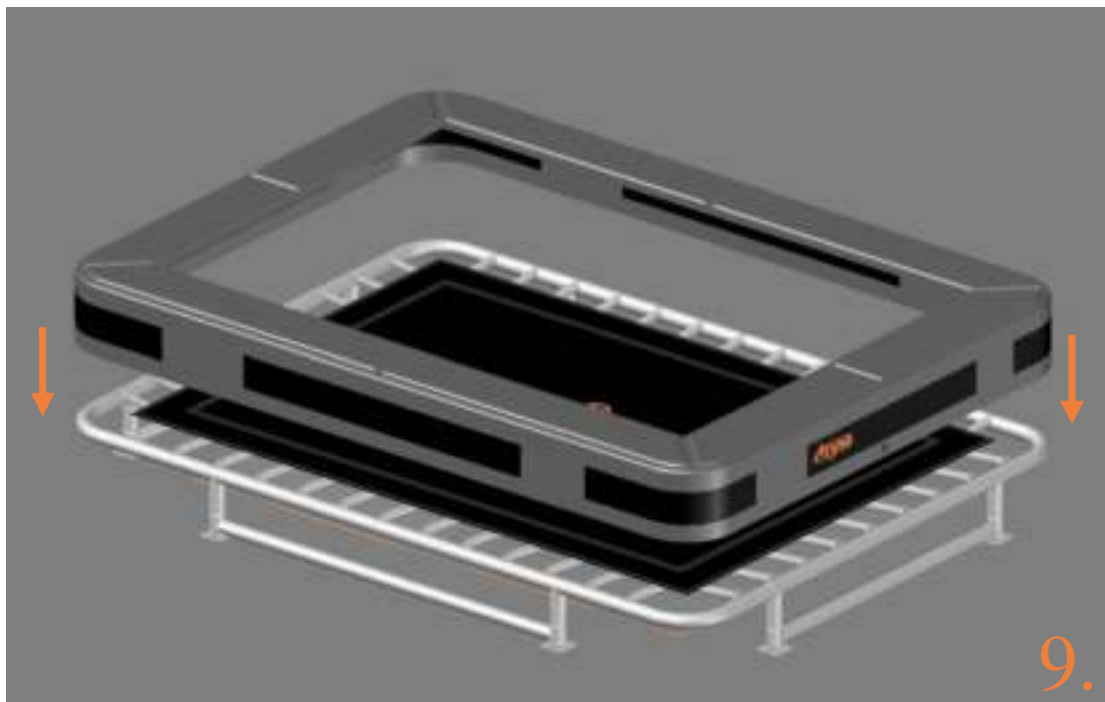

TEPL-ELAS-B

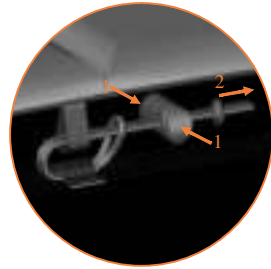

TEPL-ELAS-B



TEPL-ELAS-A





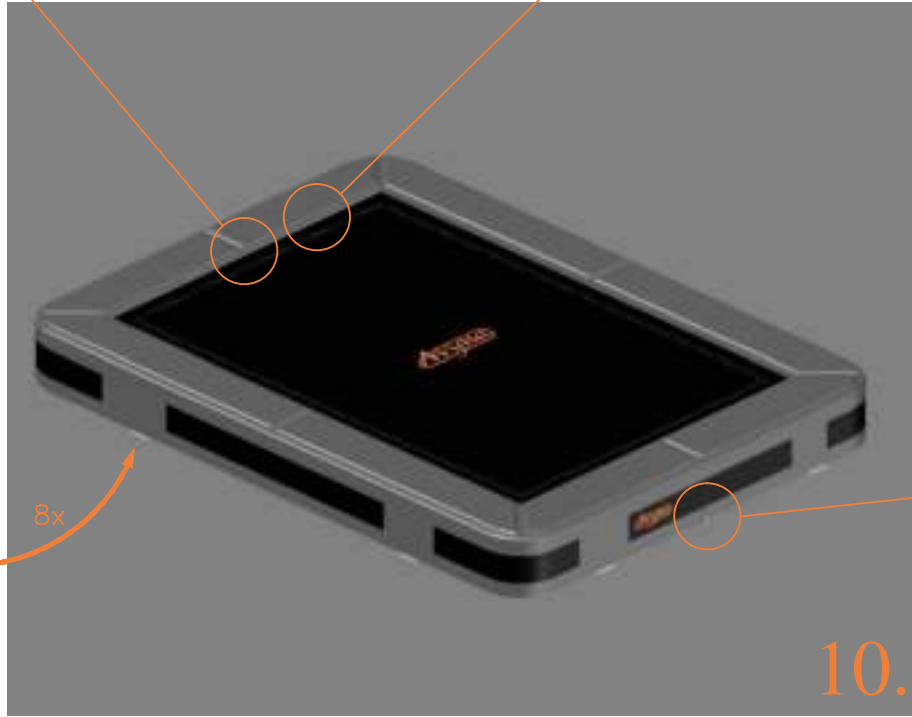





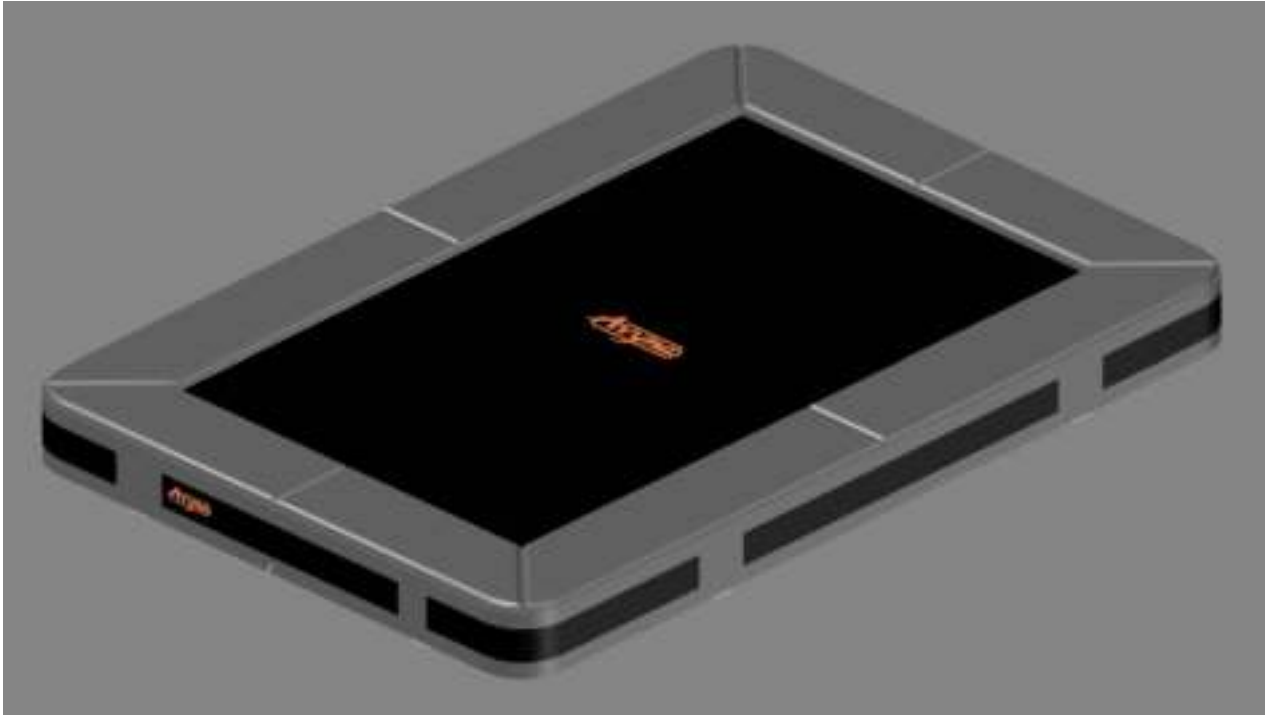

8x











10.

Model 213-I



| | Model 213-I 275x190 cm | | |
|--------------------------------------|---------------------------|---|---|
| | Quantity | Part number | |
| Jumping mat | 1 | TEPL-213-222 |  |
| Galvanized spring L=175mm, Ø3.2mm | 46 | TEPL-200-211/C (red cap) |  |
| Galvanized spring L=175mm, Ø3.8mm | 10 | TEPL-200-211/C (green cap) |  |
| Safety pad | 1 | TEPL-213-333-I-green or AVGR-213-333-I-grey of CAM-213-333-I-camouflage |  |
| Fastener for safety pad | 8 | TEPL-ELAS-A |  |
| K-tube | 2 | TEPL-213-I-1141 |  |
| L-tube | 2 | TEPL-213-I-1142 |  |
| Allen key | 2 | ALLEN KEY |  |
| Screw M6 | 4 | 090-M6-45 |  |
| Screw M8 | 8 | 090-M8-60 |  |
| Wrench M8 | 2 | WRENCH M8 |  |
| Fastener for safety pad | 20 | TEPL-ELAS-B |  |

| | Model 213-I 275 x 190 cm | | |
|-----------------------------|-----------------------------|-------------------|---|
| | Quantity | Part number | |
| H-tube | 2 | TEPL-213-I-1151 |  |
| H-tube | 2 | TEPL-213-I-1152 |  |
| Inground pin | 8 | TEPL-PIN |  |
| Inground pin for safety pad | 8 | TEPL-SP-PIN |  |
| Tool for spring | 1 | TOOL-SPRING |  |
| I-tube | 1 | TEPL-213-I-1161 |  |
| I-tube | 1 | TEPL-213-I-1162-A |  |
| I-tube | 1 | TEPL-213-I-1162-B |  |
| T-tube | 2 | TEPL-213-I-1171 |  |
| Safety Manual | 1 | 208010301 | |
| Users Manual | 1 | 208010101 | |
| Warning Card | 1 | 208040101 | |
| Tie rip for warning card | 1 | 209010102 | |

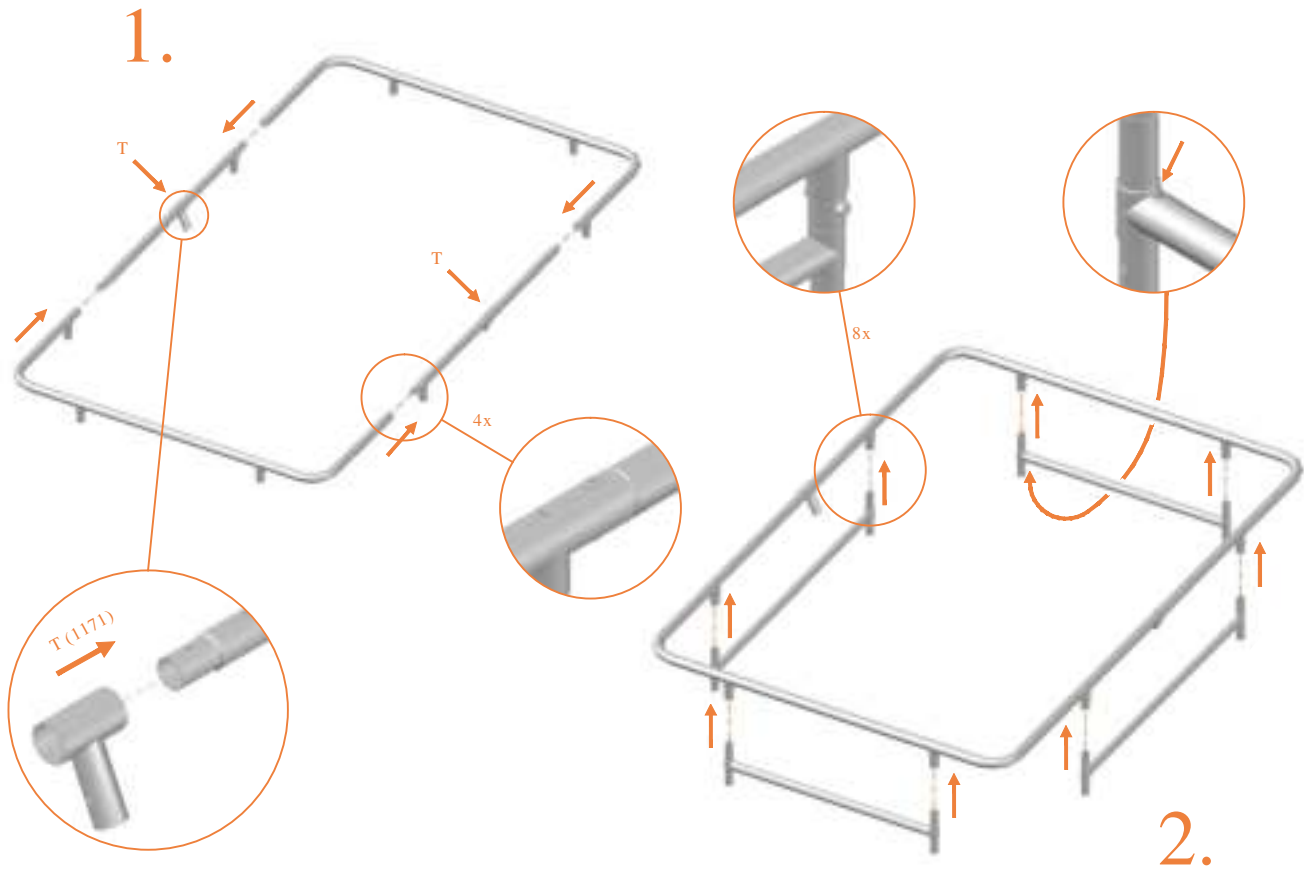

3.

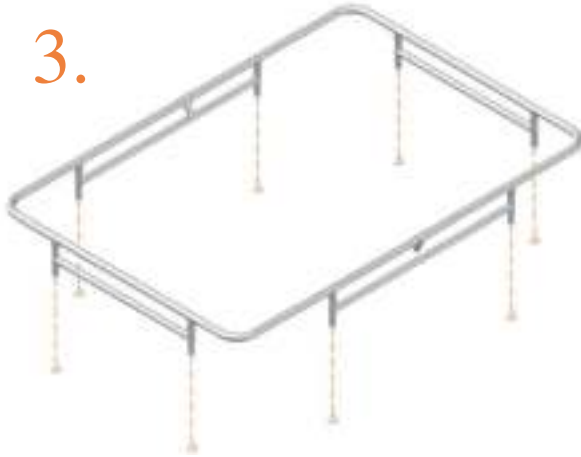

| Trampoline | Depth |
|-------------|-------|
| Model 213-i | 60cm |

4.

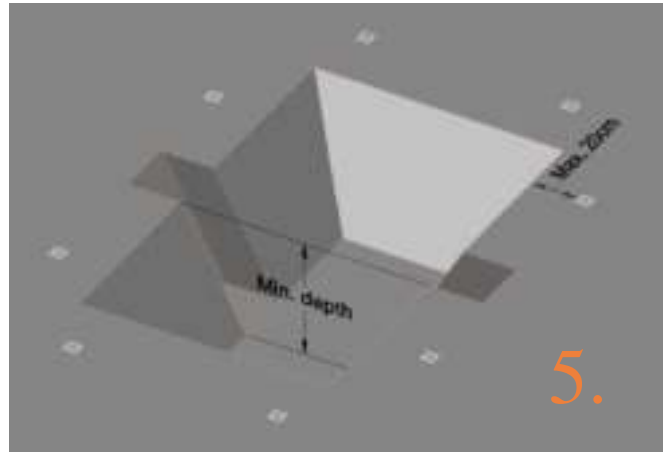
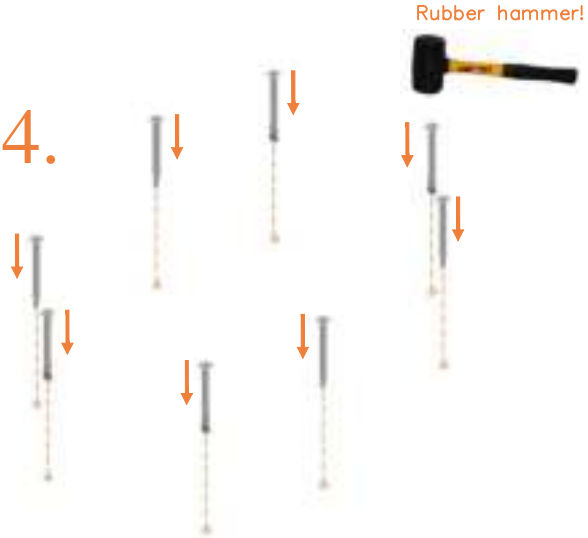

5.

6.

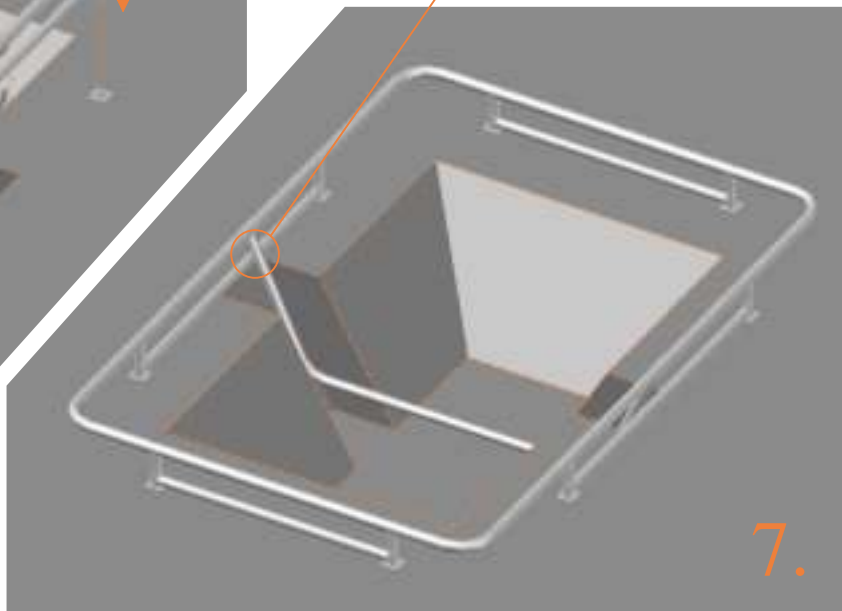
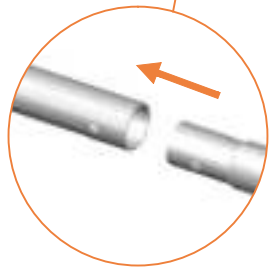
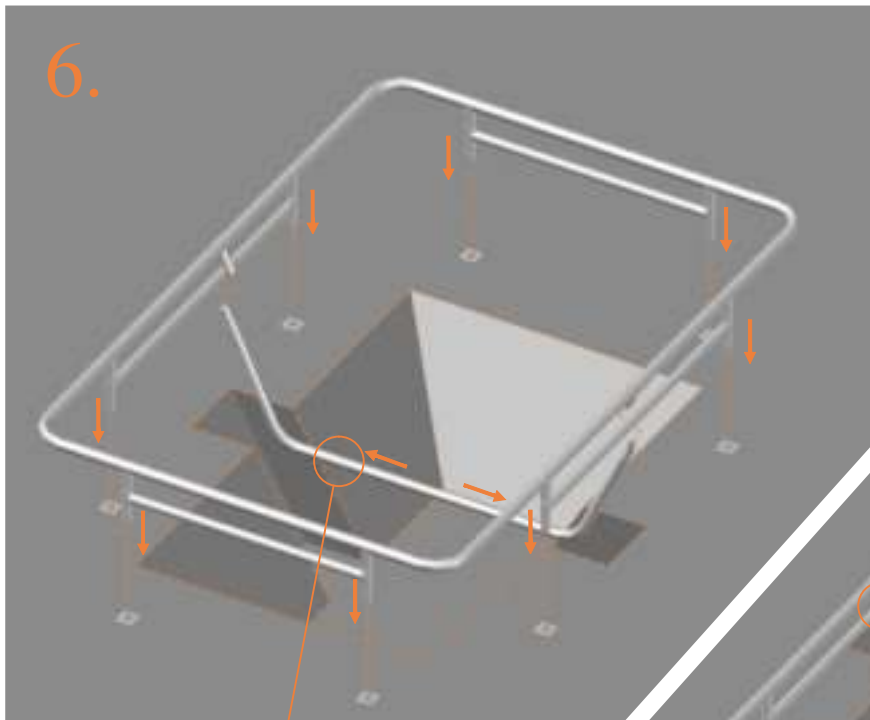

7.

8.

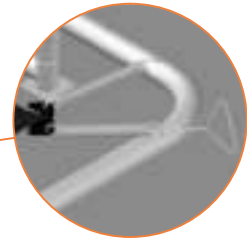

8x 175mm, \varnothing 3.2
(red cap)

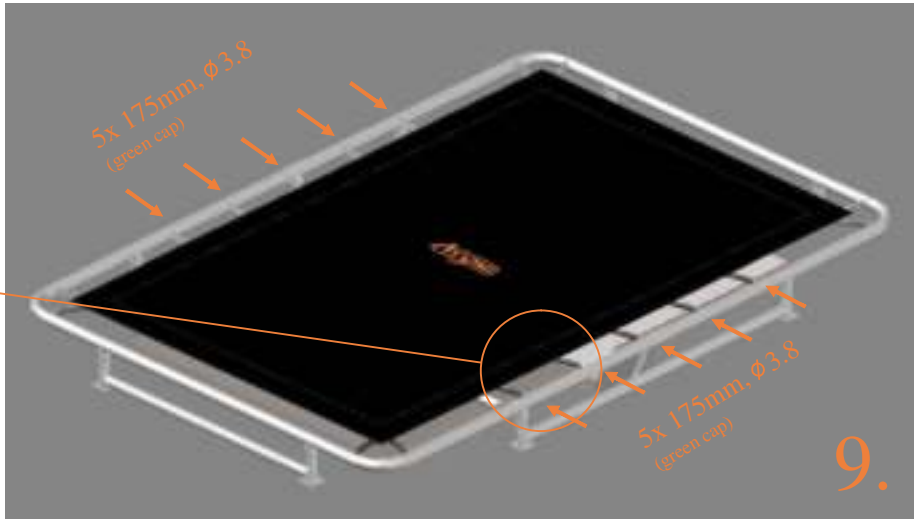
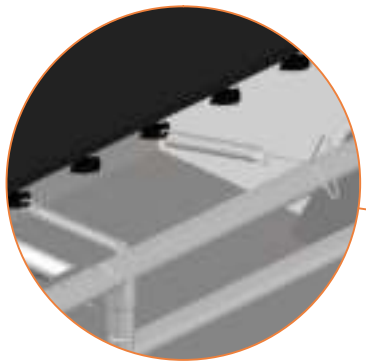

5x 175mm, \varnothing 3.8
(green cap)

5x 175mm, \varnothing 3.8
(green cap)

9.

10.

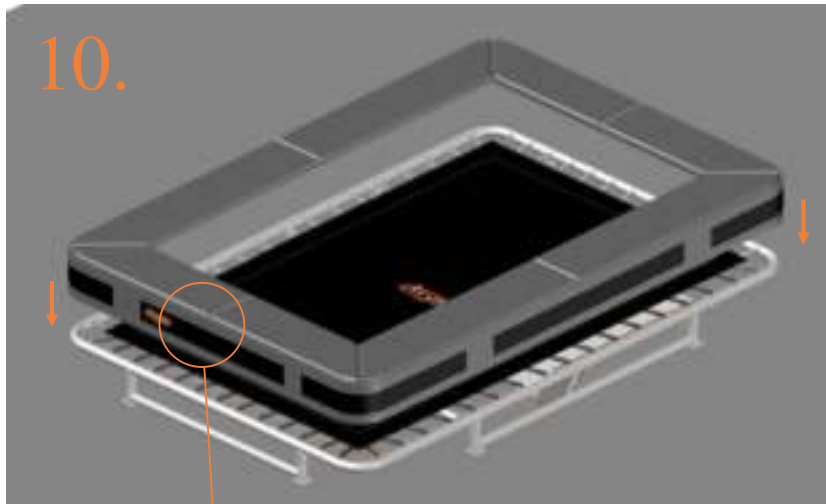

TEPL-ELAS-A

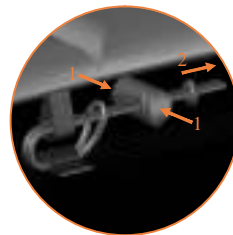

TEPL-ELAS-B

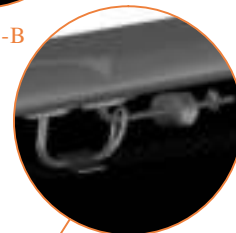

TEPL-ELAS-B

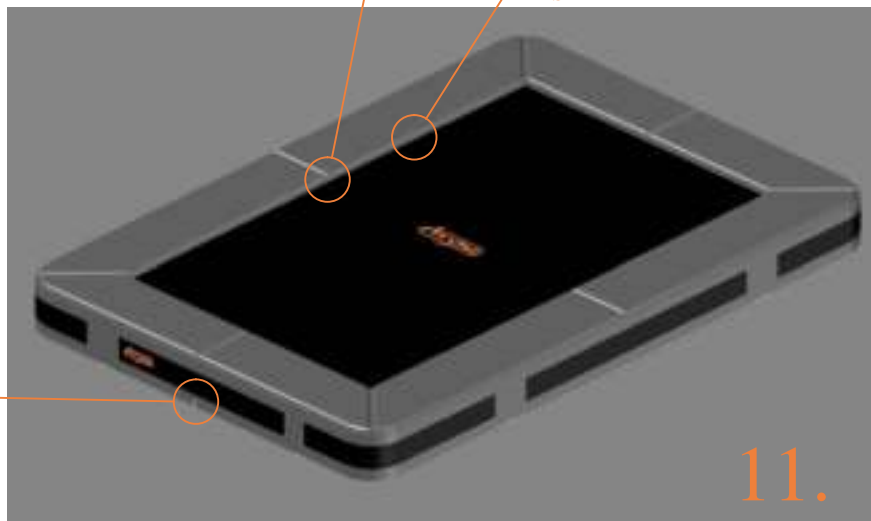

11.











Model 203-I



Model 213-I



| Model 203-I 215x155 cm | | | |
|--|-------------|---|---|
| Quantity | Part number | | |
| Pole with sleeve for safety net | 4 | AVBL-203-I-802 A |  |
| Pole for safety net | 4 | AVBL-203-I-802 B |  |
| Inground anker for pole safety net | 4 | TOOL-203-SN |  |
| Clamb for pole safety net | 8 | TEPL-KLEM |  |
| Plastic in between piece pole safety net | 4 | TEPL-PLASTIC |  |
| Safety-net | 1 | ANBL-203-I |  |
| Straps for safety net | 8 | TEPL-BAND 4x long: 1,5m(below) 4x short: 1,0m (above) |  |
| Fastening for safety net | 5 | TEPL-ELASTIC |  |
| Closure for safety net | 2 | TEPL-KNOOP |  |

| Model 213-I 275x190 | | | |
|---------------------------------|-------------|---------------------|--|
| Quantity | Part number | | |
| Pole with sleeve for safety net | 8 | AVBL-213-I-802 A |  |
| Pole for safety net | 8 | AVBL-213-I-802 B |  |
| Clamp | 8 | CLAMP-TOOL-SN-213-I |  |
| Straps for safety net | 16 | TEPL-BAND |  |
| Closure for safety net | 2 | TEPL-KNOOP |  |
| Safety net | 1 | ANBL-213-I |  |
| Screw M6 | 8 | M6-30 |  |
| Screw M8 | 32 | M8-20 |  |
| Allen key | 2 | ALLEN-KEY |  |
| Wrench | 2 | WRENCH |  |

Model 213-I

1.

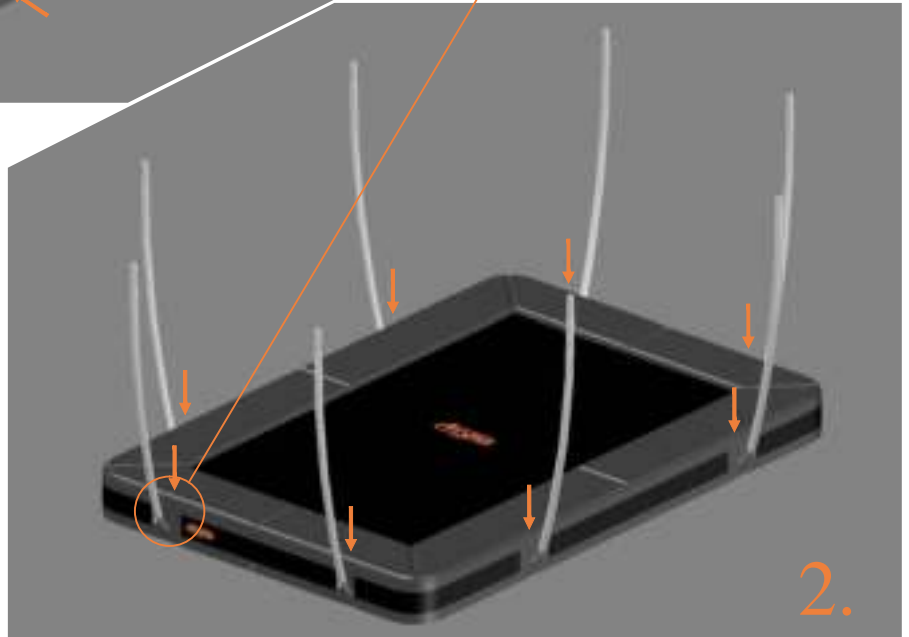
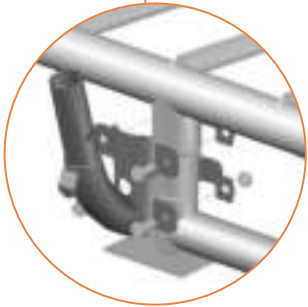

2.

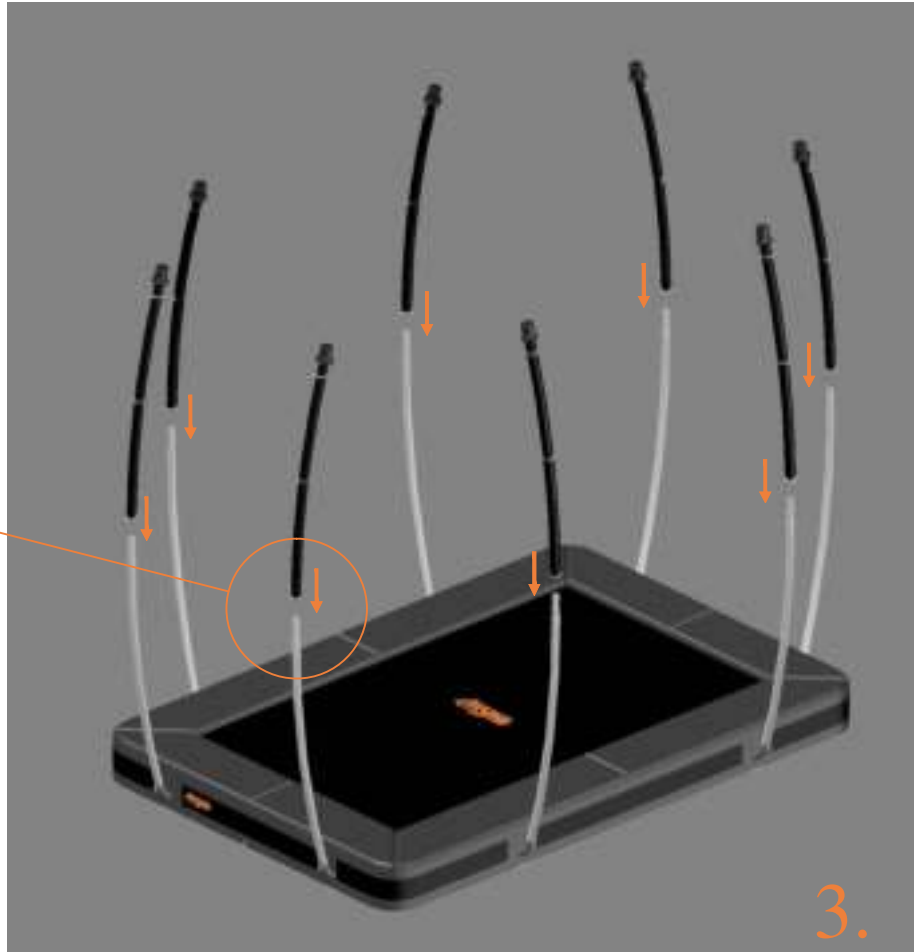

4.



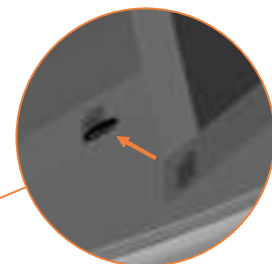
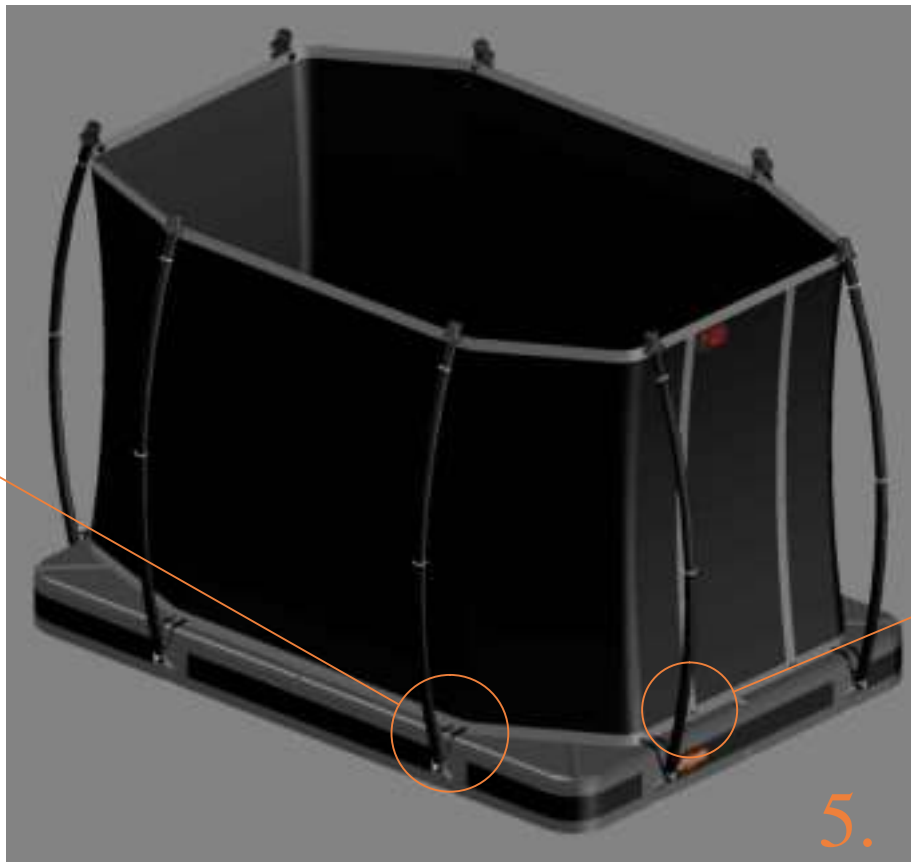
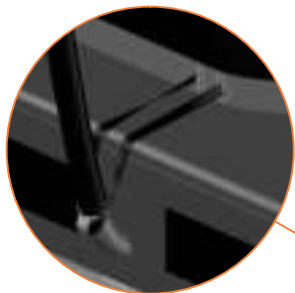



Sales office: Beneluxbaan 7
5121 DC Rijen
The Netherlands
sales@avyna.eu
www.avyna.eu