



nickelodeon

TEENAGE MUTANT NINJA TURTLES™

79118



WARNING: CHOKING HAZARD.
Small parts. Not for children under 3 years.

 **AVERTISSEMENT : RISQUE D'ÉTOUFFEMENT.**

Contient des petites pièces. Ne convient pas aux enfants de moins de 3 ans.

 **ADVERTENCIA: PELIGRO DE ASFIXIA.**

No recomendado para niños menores de 3 años.
Contiene piezas pequeñas.



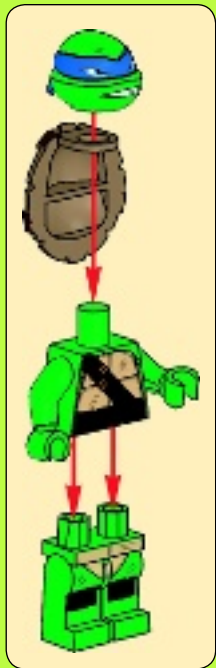



1x



1x



1x



1x



1x

1



2



3

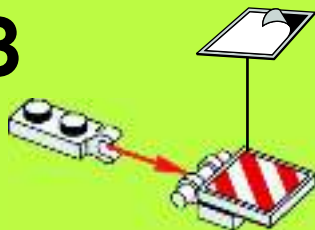

4

4

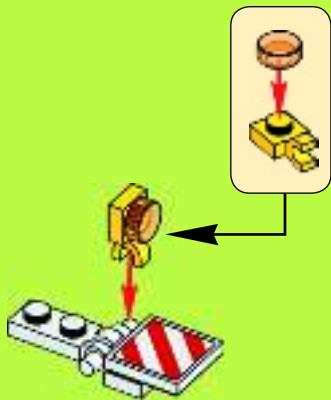

5



1x

1



6



2x

2

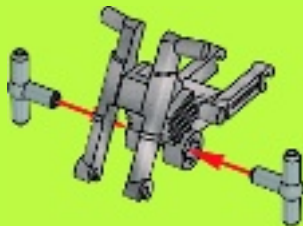



3

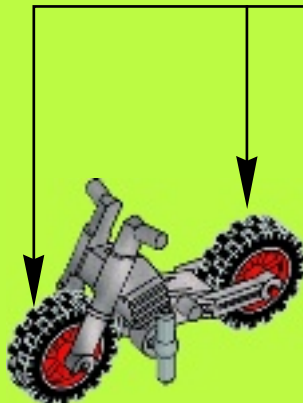



1x

4



8

5

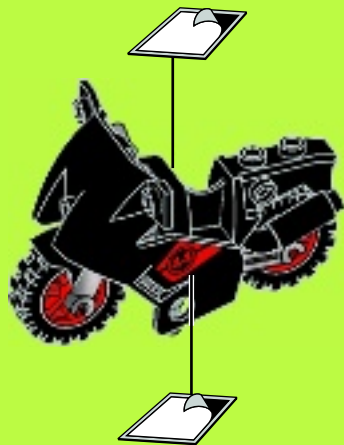

6

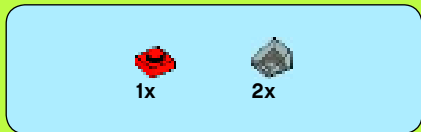



1x



1x



1x



1x



1x

7

1



2



3



4





1x



1x



1x

8



1



2





9

1



2



3



4





1x



1x

10





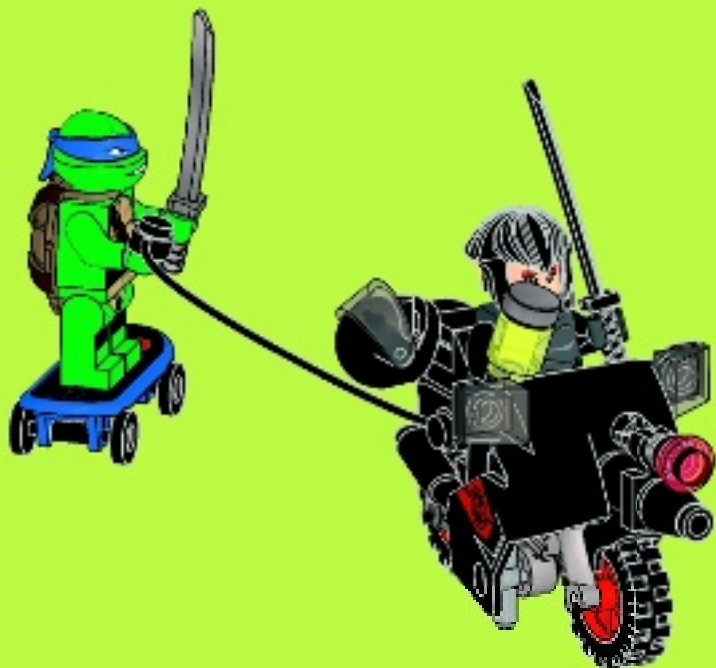



1x



1



1x



1x

2



1x



1x



1x

3





1x



1x

4



1x



1x

5

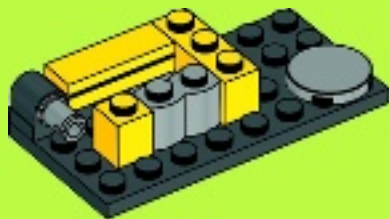



2x



1x



1x

6

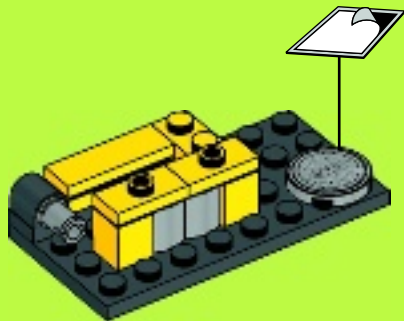

7

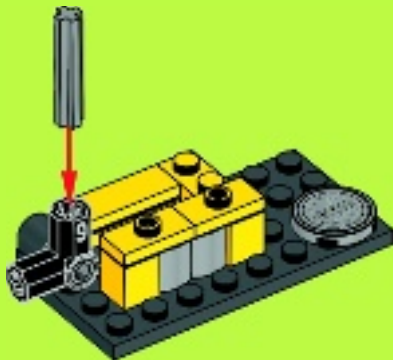



1x

1

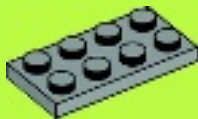

2x

2

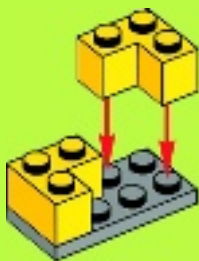



4x



2x



1x

3

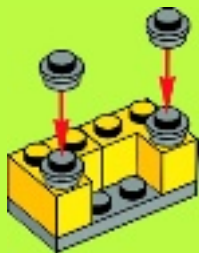

4

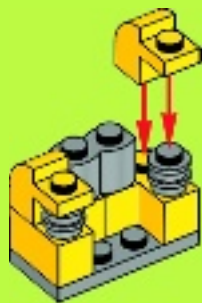



1x



1x

5

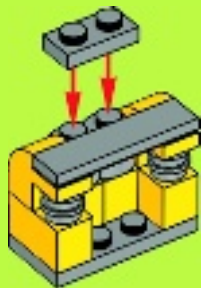

8

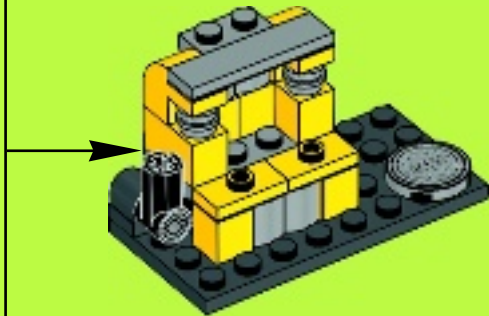



1x

9

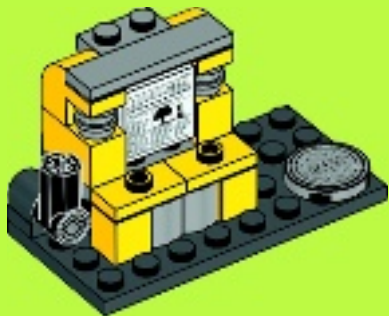



1x



2x

1

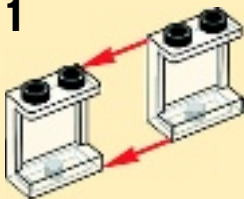

2

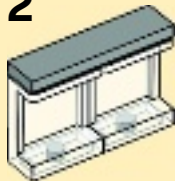

10

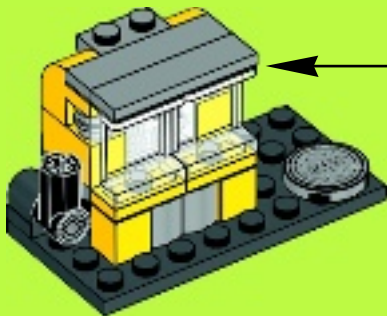



1x



1x



2x

11

1



2





1x



1x

1



1x

2

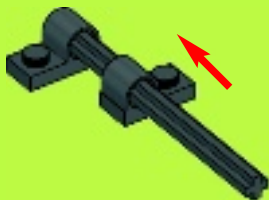



1x

3



2x

4

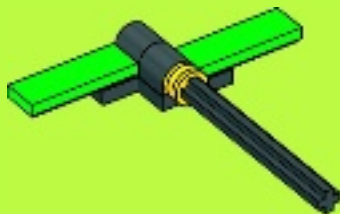

5

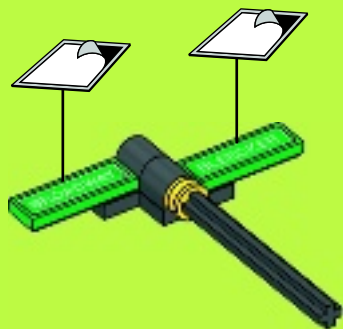

12

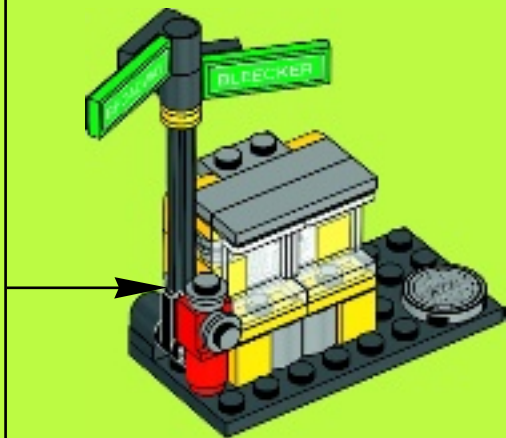



1x
306801



1x
4140583



1x
4535737



1x
4655208



1x
407021



1x
306221



1x
302421



2x
6074771



1x
4172695



1x
300524



2x
235724



1x
362224



2x
4188357



2x
379424



1x
362324



1x
4558172



1x
4540040



1x
4239601



1x
306226



1x
4529236



1x
6069000



1x
6047276



1x
302326



1x
6030718



1x
4550017



1x
4569733



1x
307026



1x
6073113



1x
6070306



1x
4298619



1x
4598897



2x
249626



1x
4107767



2x
6064174



1x
4114206



1x
6074769



1x
6037558



2x
6023083



1x
6073117



1x
6024647



1x
6072985



2x
6000740



1x
3005741



1x
4107106



2x
4244368



1x
4163306



1x
6023062



1x
4646865



2x
4550325



2x
4211398



2x
4211356



1x
4211395



1x
4655241



1x
6072873



1x
6073035



1x
4623236



3x
6019987



1x
4499858



1x
4211061



6x
4211525



1x
6052200



1x
4550170



1x
4211807



1x
4211815



2x
4211508



1x
4612900



1x
6055651

Customer Service

Kundenservice

Service Consommateurs

Servicio Al Consumidor

LEGO.com/service or dial



00800 5346 5555 :



1-800-422-5346 :







LEGO.com/turtles

79118



79119



79120



79121



©2014 Viacom International Inc. All Rights Reserved. Nickelodeon, Teenage Mutant Ninja Turtles and all related titles, logos and characters are trademarks of Viacom International Inc. ©2014 Viacom International Inc. Tous droits réservés. Nickelodeon, Les Tortues Ninja et tous les titres, logos et personnages qui s'y rapportent sont des marques de commerce de Viacom International Inc. ©2014 Viacom International Inc. Todos los derechos reservados. Nickelodeon, Teenage Mutant Ninja Turtles y todos los títulos, logotipos y personajes relacionados son marcas comerciales de Viacom International Inc. nick.com/tmnt



WIN!

Go to LEGO.com/productfeedback to fill out a survey for a chance to win a cool LEGO® Product.

No purchase necessary.

Open to all residents where not prohibited.



LEGO.com/productfeedback

GEWINNE!

Nimm an der Umfrage auf LEGO.com/productfeedback teil und hab die Chance ein cooles LEGO® Produkt zu gewinnen!

Die Teilnahme am Gewinnspiel führt zu keinerlei Kaufverpflichtungen. Teilnahme in allen nicht ausgeschlossenen Ländern möglich.

WIN!

Ga naar LEGO.com/productfeedback, vul een enquêteformulier in en maak kans op een cool LEGO® product.

Geen aankoopverplichting. Ledereen mag deelnemen, uitgezonderd ingezetenden van landen waar een enquêteverbod geldt.

GAGNE !

Visite LEGO.com/productfeedback pour répondre à un questionnaire et avoir une chance de gagner un produit LEGO® très cool !

Aucune obligation d'achat. Ouvert à tous les résidents des pays autorisés.

当てよう!

LEGO.com/productfeedback にアクセスして、アンケートにご記入ください。当選者にはレゴ®製品を差し上げます。

お買い上げの必要はありません。禁止されていない限り、すべての皆様にご利用いただけます。



6083341

LEGO and the LEGO logo are trademarks of the/sont des marques de commerce de/son marcas registradas de LEGO Group. ©2014 The LEGO Group.