



KNAAP BIKES

KNAAP BIKE RTD

USER MANUAL



WWW.KNAAPBIKES.COM

© Copyright KNAAP BIKES

1. INTRODUCTION 7

- 1.1 About this user manual 7
- 1.2 Typographic conventions 8
- 1.3 Additional documentation 8
- 1.4 Contact details 9

2. ASSEMBLING THE BIKE 10

- 2.1 Product elements 10
- 2.2 Installing the bike components 14
 - 2.2.1 What is in the box? 14
 - 2.2.2 Installing the front mudguard 15
 - 2.2.3 Installing the front wheel 16
 - 2.2.3.1 Installing the front wheel in the front fork 16
 - 2.2.3.2 Installing the braking system 19
 - 2.2.4 Installing/adjusting the handlebar 21
 - 2.2.5 Installing the pedals 24

3 SAFETY	25
3.1 Safety notes - eBike safety fundamentals	25
3.2 Safety notes - eBike battery and charger	26
4 RIDING THE BIKE	27
4.1 Using the battery	27
4.1.1 Installing the battery	28
4.1.2 Charging the battery	29
4.1.3 Removing the battery	31
4.1.4 Storing the battery	32
4.1.5 Battery status LEDs	32
4.2 Using the brakes	34
4.3 Speed control system (with LCD display)	35
4.3.1 Adjusting the angles of the LCD display and speed controller	36
4.3.2 Switching the LCD display on and off	38
4.3.3 Overview of the main screen	40
4.3.3.1 Battery power level	41
4.3.3.2 Changing the trip information	41

TABLE OF CONTENT

4.3.4	Using the pedal assist	42
4.3.5	Switching the rear and front light on/off	44
4.3.6	Using the walk assist mode	44
4.3.7	Using the USB port	45
4.3.8	Charging the battery of the LCD display	45
4.3.9	Changing the system settings	46
4.3.9.1	Opening the menu	48
4.3.9.2	Navigating in the menu	48
4.3.9.3	Display settings	49
4.3.9.4	Basic settings	53
4.3.9.5	Error codes	58
4.4	Using the gear shifter	59
4.5	Using the lighting system	61
4.5.1	Front light and rear light	61
4.5.2	Reflectors	61
4.6	Recommendations for first-time eBike riders	62
4.6.1	Getting acquainted with the bike	62
4.6.2	Mechanical safety check before riding	63

5 MAINTENANCE	65
5.1 Cleaning the bike	66
5.2 Adjusting the chain tension	68
5.3 Lubricating the bike	70
5.4 Maintenance schedule	73
5.5 Torque settings	76
6 TRANSPORT AND STORAGE	77
6.1 Transporting the bike and the battery	77
6.1.1 Transporting the bike	77
6.1.2 Transporting the battery	78
6.2 Storing the bike	78
7 PROBLEM SOLVING	80

8 ENVIRONMENT AND DISPOSAL	87
8.1 Disposal of electronic components	87
8.2 Disposal of packaging material	88
9 DISCLAIMER	89
10 TECHNICAL DATA	90
11 MAINTENANCE FORMS	91

1. INTRODUCTION

1.1 ABOUT THIS USER MANUAL



IMPORTANT
READ CAREFULLY BEFORE USE
KEEP FOR FUTURE REFERENCE

This user manual is primarily intended for the Knaap bike owner. Make sure that you read and understand this manual and the safety instructions contained herein before using the Knaap bike. Failure to do so can result in serious injury or death.

Obey all instructions. This will avoid the risk of fire, explosions, electric shocks and other hazardous situations that can result in damage to property and/or severe or fatal injuries. The Knaap bike is equipped with a lithium-battery. Please make sure that you read and understand all safety precautions when charging and using the battery of your Knaap bike.

Keep all safety information and user instructions for future reference. The manufacturer cannot be held liable for any material damage or personal injury caused by incorrect handling of the Knaap bike or not obeying the safety instructions. Using the Knaap bike for other than its intended purpose, not maintaining the bike properly and replacing components by non-original components will void any warranty claims.

1.2 TYPOGRAPHIC CONVENTIONS

The following symbols are used in this user manual:

▲ DANGER

Danger indicates a hazardous situation that, if not avoided, will result in death or serious injury.

▲ WARNING

Warning indicates a hazardous situation that, if not avoided, may result in death or serious injury.

▲ CAUTION

Caution indicates a hazardous situation that, if not avoided, may result in minor or moderate injury.

NOTICE

Notice indicates information considered important, but not hazard-related.

1.3 ADDITIONAL DOCUMENTATION

- Documentation of the Bafang C961 display
- Documentation of the Bafang rear wheel drive unit
- Documentation of the Samsung 36V 21Ah battery
- Documentation of the Shimano 7-speed shifter

1.4 CONTACT DETAILS

This is the original English user manual. The latest version of this manual is available at: www.knaapbikes.com. Manuals in other languages are available upon request. Should you have any questions, or if you need technical assistance or information about special tools and materials, or if you would like to order spare parts, please contact: support@knaapbikes.com

Send us any feedback you may have by visiting our website or sending us an e-mail. We appreciate your comments!

Technical support

Should you need technical support, please contact your local Knaap retailer or support@knaapbikes.com.

2. ASSEMBLING THE BIKE

2.1 PRODUCT ELEMENTS

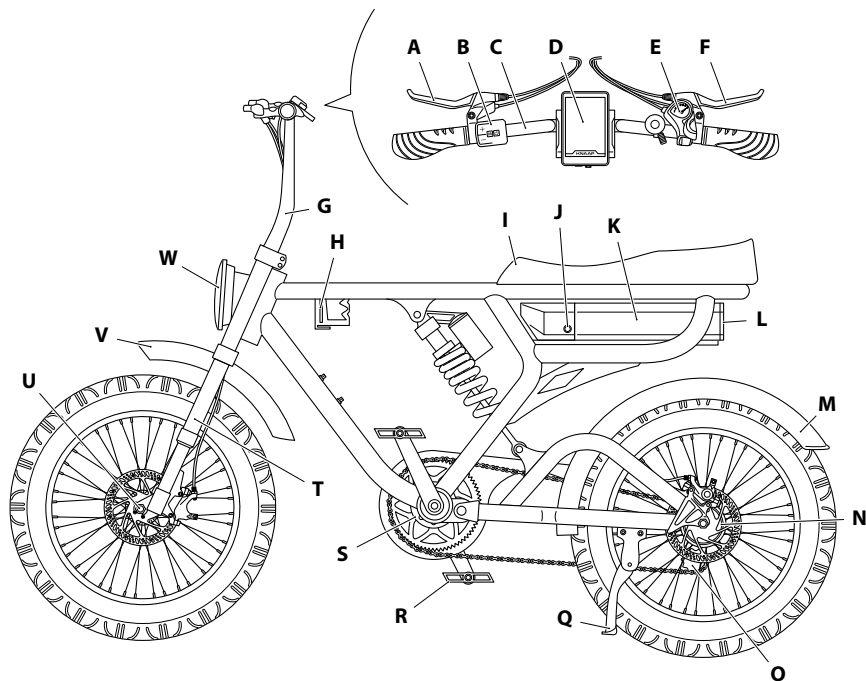

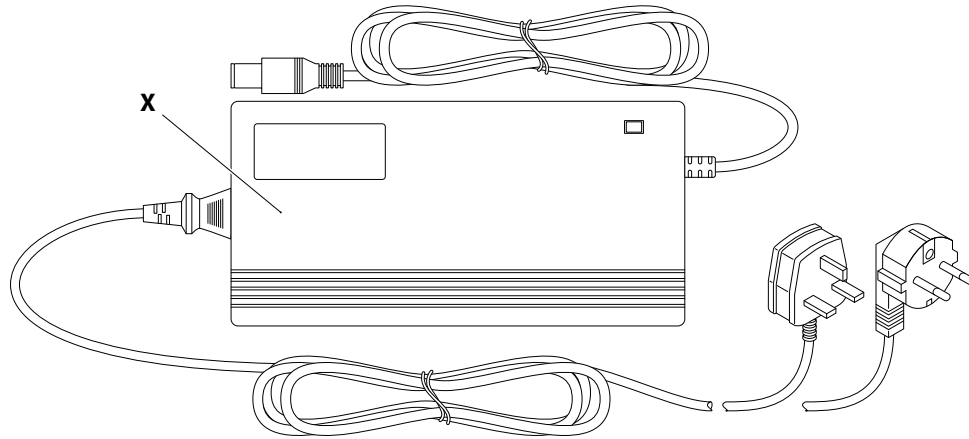

- | | | | | | |
|-----------|---|-----------|----------------------|-----------|---------------------|
| A. | Brake | H. | Mug holder | Q. | Bike stand |
| B. | Power Button, Speed controller and light button | I. | Saddle | R. | Pedal |
| C. | Handlebar | J. | Battery lock | S. | Pedal assist sensor |
| D. | LCD console | K. | Battery | T. | Front fork |
| E. | Gear shifter | L. | Rear light/reflector | U. | Wheel axle |
| F. | Brake | M. | Rear mudguard | V. | Front mudguard |
| G. | Stem | N. | Rear hub motor | W. | Headlight |
| | | O. | Derailleur | X. | Charger |
| | | P. | Passenger foot rest | | |

Spare part box

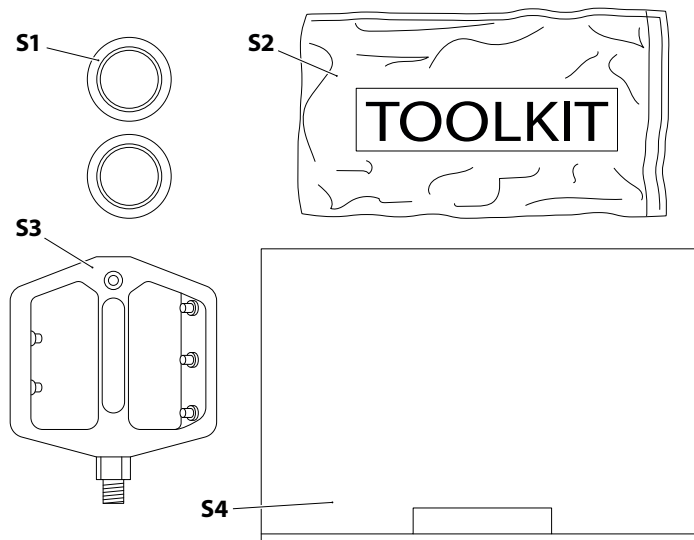

- S1** Rubber dust covers
- S2** Toolkit (see *Toolkit*)
- S3** Pedals
- S4** Charger

Toolkit

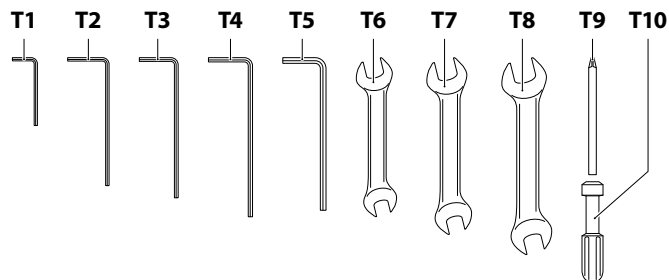

- | | | | | | |
|-----------|--|-----------|---|------------|--|
| T1 | Allen key 3mm (to adjust the power button, speed controller and light button ⑥) | T4 | Allen key 5mm (to adjust the handlebar) | T7 | Wrench 13/15 (to mount the pedals ③ and the front wheel) |
| T2 | Allen key 4mm (to adjust the LCD console ⑦) | T5 | Allen key 6mm | T8 | Wrench 17/19 |
| T3 | Allen key 4,5mm (to adjust the passenger foot rest ⑧ and install the mudboard ⑨) | T6 | Wrench 8 (to install the mudboard ⑨) | T9 | Screwdriver |
| | | | | T10 | Socket for screwdriver |

2.2 INSTALLING THE BIKE COMPONENTS

CAUTION

An overview of all torque values can be found in *section 5.5 Torque settings*.

2.2.1 WHAT IS IN THE BOX?

1. Open the packaging and remove the bike, the charger and the parts box.
2. Do a visual inspection of the packaging contents:
 - Bike **NOTICE** The front mudguard, front wheel, handlebar, pedals and braking system are still to be mounted.
 - Parts box
 - Toolkit
 - User manual
3. Remove the foam sleeves from the bike and discard them in accordance with your local waste disposal regulations.

2.2.2 INSTALLING THE FRONT MUDGUARD

Tools/Material required:

- Front mudguard ⑤
- Allen key 4.5 mm ③
- Wrench 8 ⑥

1. Remove the **front mudguard** ⑤ from the packaging.
2. Attach the **front mudguard** ⑤ onto the **lower plate** ① with the **allen key** ③ and **wrench** ⑥.

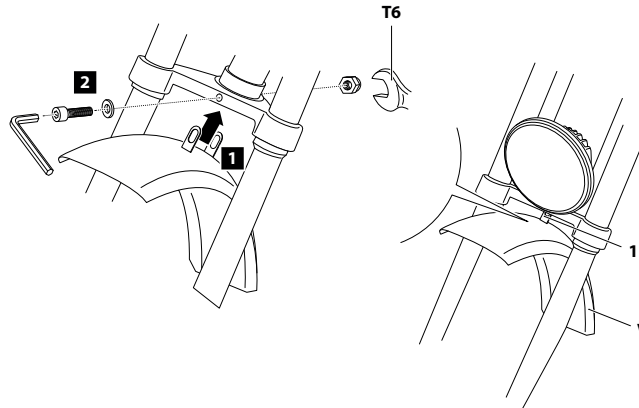

2.2.3 INSTALLING THE FRONT WHEEL

2.2.3.1 INSTALLING THE FRONT WHEEL IN THE FRONT FORK

Tools/Material required:

- Allen key 4.5mm (Ⓜ3) and Wrench 13/15 (Ⓜ7)

1. Make sure that the foam protection sleeves are removed from the handlebar.
2. Remove the **front fork spacer** ①.

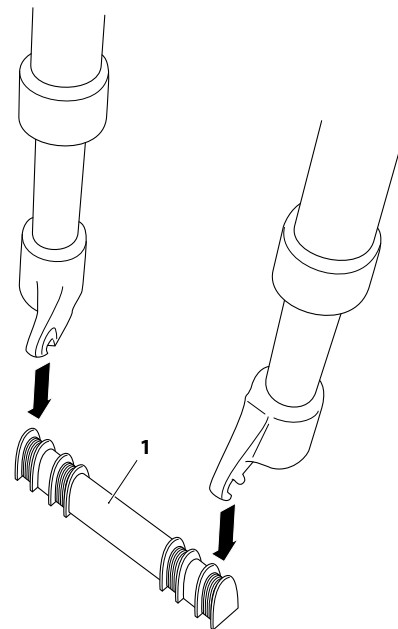

- Put the **wheel axle** ② into the **front fork dropouts** ①.

⚠ CAUTION

Risk of injury. The front wheel axle must be fully seated into the dropouts. If the wheels are not secured in place, they can go askew or come out of the dropouts.

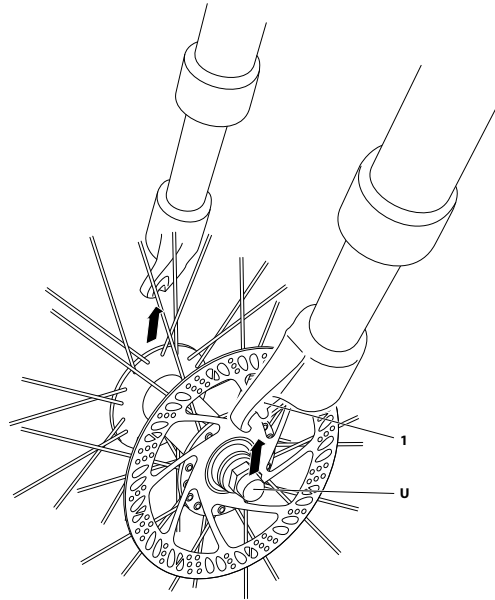

4. Hold the **end nut** ① and turn and tighten the **wheel axle** ②.

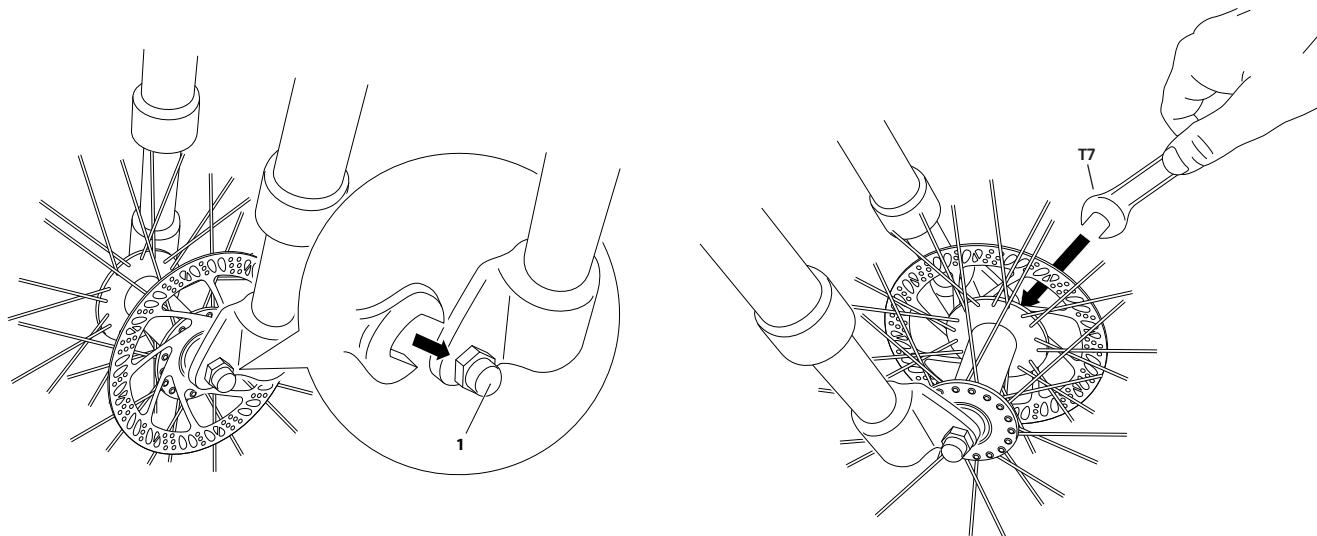

5. Make sure that the **front mudguard** ⑤ does not touch the front tire.

2.2.3.2 INSTALLING THE BRAKING SYSTEM

1. Remove the red distance holder from the brake system.

NOTICE: Do not use the brake lever until the brake system is fitted onto the front fork.

2. Attach the braking system to the front fork with the **allen key** ①3.

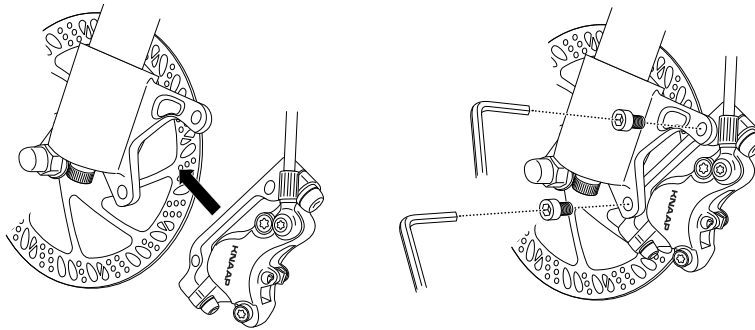

2. ASSEMBLING THE BIKE

3. Loosen the two braking system nuts with the **allen key** ①3.

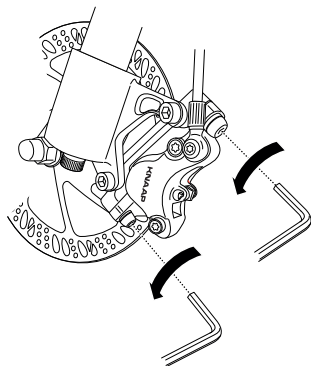

4. Press the brake lever and tighten the two braking system nuts again.

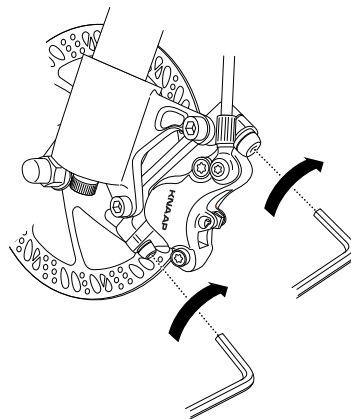
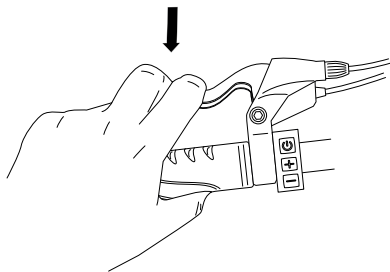

5. Release the brake lever.

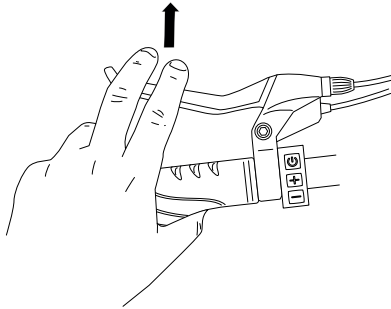

2.2.4 INSTALLING/ADJUSTING THE HANDLEBAR

Tools/Material required:

- Allen key 5mm ④.

1. Remove the **handlebar** ③ from the packaging.
2. Take the **two rubber dust covers** ① from the parts box.
3. Slide the **dust covers** ① onto the lower end of each of the **handlebar stems** ①.
4. Slide the **handlebar stems** into the **bike frame** ②.

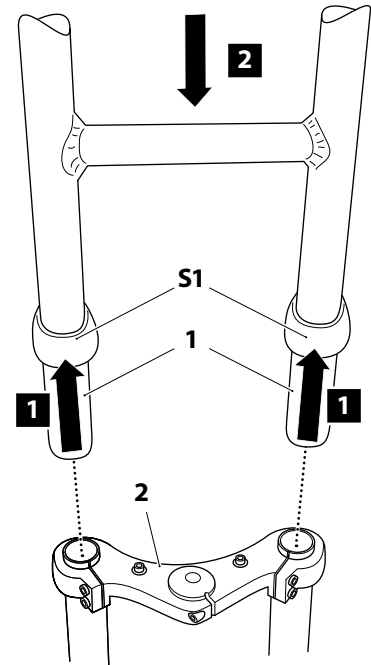

5. Make sure that the **ribbed insertion marks** ① are fully inserted into the **bike frame** ②.

⚠ CAUTION

Risk of injury. The height of the handlebar stems can be adjusted to the user's preferences, but the safety mark must NOT be visible.

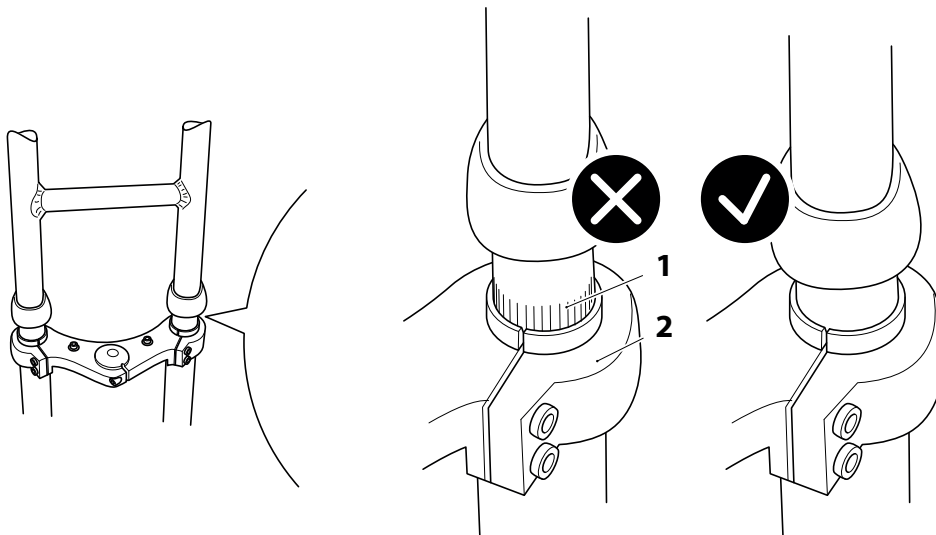

6. Tighten the **bolts** ① of the **stem clamps** ② with **allen key** ④ .

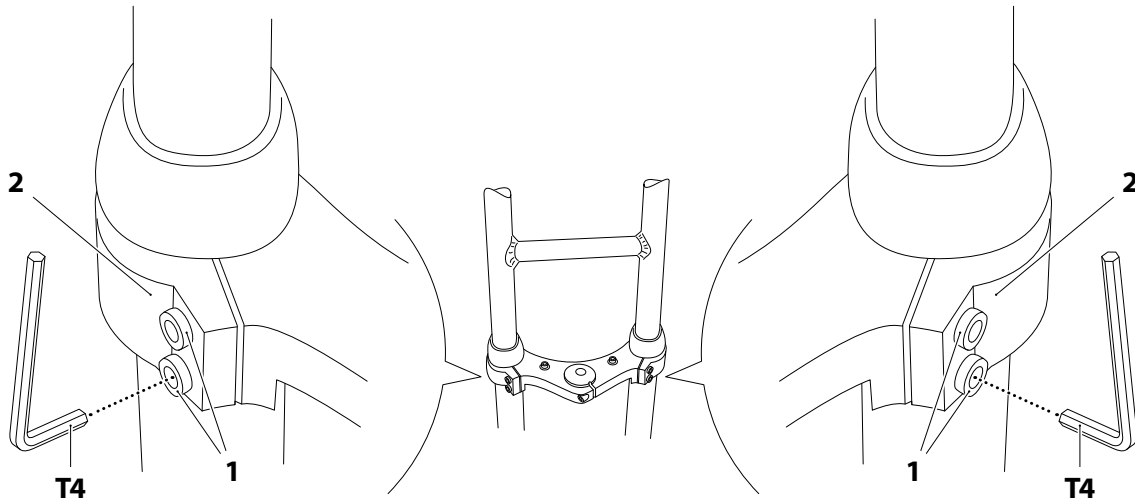

2.2.5 INSTALLING THE PEDALS

Tools/Material required:

- Pedals ③3
- Wrench 13/15 ①7

NOTICE

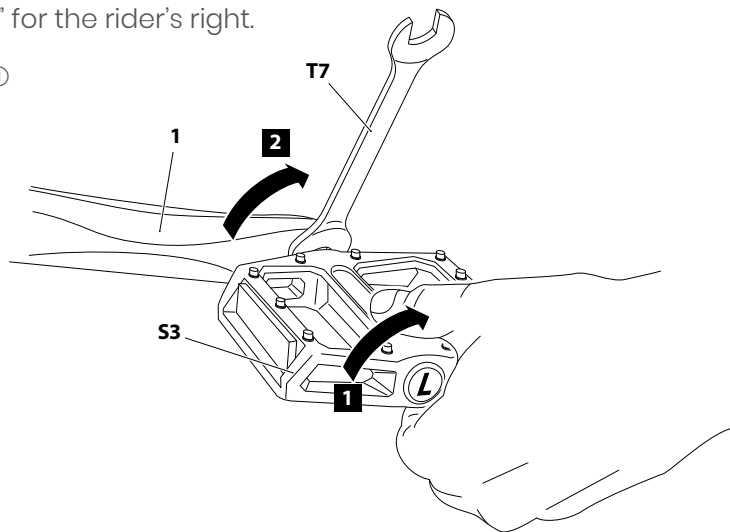

The left pedal is threaded in the opposite direction, and must be tightened by turning it counterclockwise. This is standard on most bikes.

1. Check the **pedals** ③3 before installation:
They are labeled “L” for the rider’s left, “R” for the rider’s right.
2. Turn the **pedal** ③3 into the **crank arm** ① with your hand.
NOTICE Always make sure to turn the pedal towards the front wheel.
3. Once the **pedal** ③3 becomes too difficult to turn:
Tighten the **bolt** with the **wrench** ①7.



3 SAFETY

3.1 SAFETY NOTES – EBIKE SAFETY FUNDAMENTALS

- Always wear a helmet.
- Wear bright, highly visible clothing, preferably with reflective tape or patches.
- Obey the rules of the road. Stop at stop signs and lights.
- Stay in control:
 - Remember to use a low gear when you start off. The power comes in at the second rotation of the pedals.
 - At intersections, other drivers may not expect you to start off at speed. Wait on your eBike where you can be easily seen.
 - Before passing, look behind you for traffic, and signal before pulling out. Give enough space when passing and let the other person know by ringing your bell.
- Always ride at a safe speed that allows you to react quickly to unexpected circumstances.
- Always use your front and rear bike lights and reflectors in low-light or dark conditions.
 - Press and hold the  **button** to turn on the rear light and the front light of the bike.
 - Press and hold the  **button** again to turn the rear light and the front light of the bike off.

- Extend the battery range by using lower power settings and pedalling more.
- Remember to charge your battery every day you use it.

3.2 SAFETY NOTES – EBIKE BATTERY AND CHARGER

- NEVER use a battery that seems to be damaged.
- NEVER charge a battery at temperatures below 4 °C (40 °F).
- NEVER charge a battery that has been exposed to saltwater.
- NEVER leave the battery unattended in case of indoor charging.
- NEVER charge the battery near flammable materials.
- ALWAYS use the charger that comes with your Knaap bike.
- ALWAYS charge and store the battery in a dry environment.
- NEVER charge the battery with charger cables that are damaged.

4 RIDING THE BIKE

4.1 USING THE BATTERY

⚠ WARNING



- Risk of explosion. The battery and the dock must be dry before installation. Dry the battery and the dock with a soft cloth, if required.
- Risk of explosion. Do NOT charge or use a battery that is damaged. If the battery is damaged, it must be discarded immediately.

TIP

- The Knaap bike is powered by a 36 V, 21 Ah lithium-ion battery. The battery is a critical component and one of the most expensive components to replace. Make sure that you follow our recommendations to maximize the service life of your battery.
- Take into account that the battery performance and the bike range depends on quite some factors, including load, tire pressure, driving circumstances, operational temperature, the extent to which the bike rider is actively pedalling and the rider's gear shifting behaviour.

4.1.1 INSTALLING THE BATTERY

1. If installing the **battery**  for the first time:

- Remove the **battery**.
- Remove the packaging from the **battery** and discard the packaging in accordance with the local disposal regulations.
- Remove the **battery key**. The **battery key** is attached to the **handlebar** .
- Always make sure that the **ON/OFF button**  of the battery is in the **OFF** position.
- Insert the **battery**.
- Insert and turn the **battery key**  clockwise, to lock the **battery**.

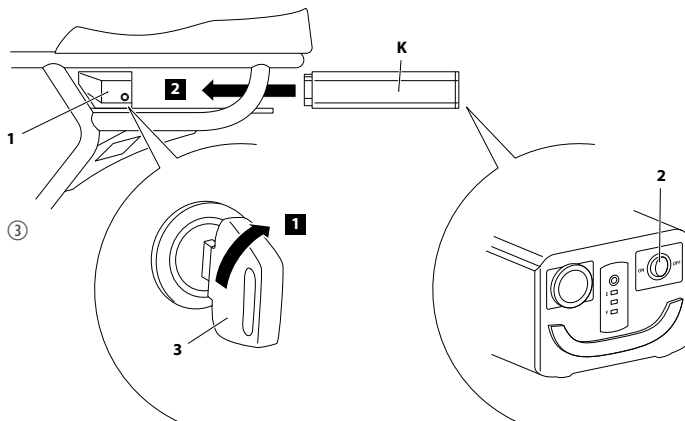

NOTICE

When installed correctly, the battery key has a motion range of 180°.

4.1.2 CHARGING THE BATTERY

NOTICE

- The battery can be charged directly on the bike or separately. After charging, the charger must be disconnected from the battery and the AC power socket immediately.
- Charging a new battery takes approximately 8-9 hours. If you discharge the new battery and recharge it within a week, all relevant substances within the battery are activated, which elongates the lifetime of the battery.
- Charging a battery during normal usage: When a battery is fully depleted, it takes approximately 6-8 hours to charge it.

1. Make sure that you follow the procedural steps in the sequence described below.
2. Make sure that the **ON/OFF button** ① of the **battery** ② is in the **OFF** position.
3. Connect the **input plug of the charger** ④ to the charger.
4. Connect the **power plug** to the AC power socket.
 - The **charger LED** lights up **green**.

5. Connect the **output plug of the charger** ② to the **input jack of the battery** ③.
- The **charger LED** lights up red.

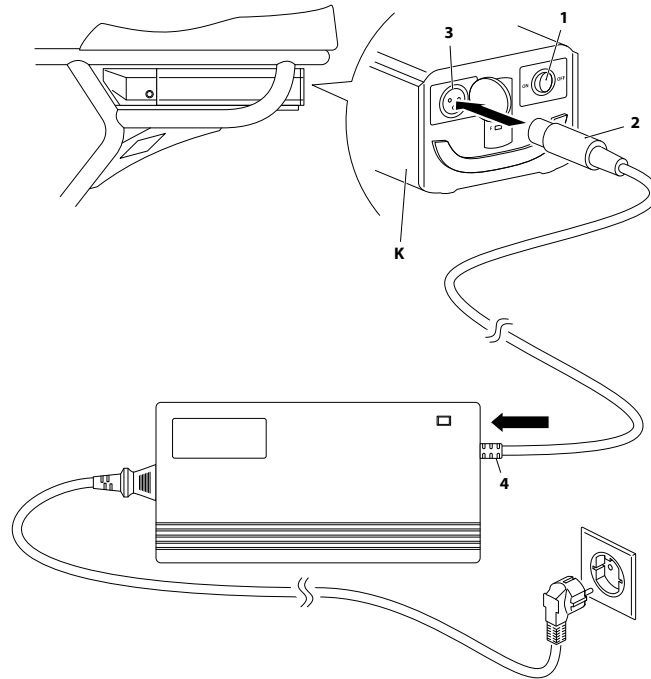

6. When the battery is fully charged:
 - a. The **charger LED** lights up **green**.
 - b. Remove the **output plug of the charger** from the **battery** Ⓚ.
 - c. Remove the **power plug of the charger** from the AC power socket.

4.1.3 REMOVING THE BATTERY

1. Unlock the battery: Turn the **battery key** ① counterclockwise.
2. Make sure that the **ON/OFF button** ② of the **battery** Ⓚ is in the **OFF** position.
3. Remove the **battery** Ⓚ from the dock and slide it to the rear.

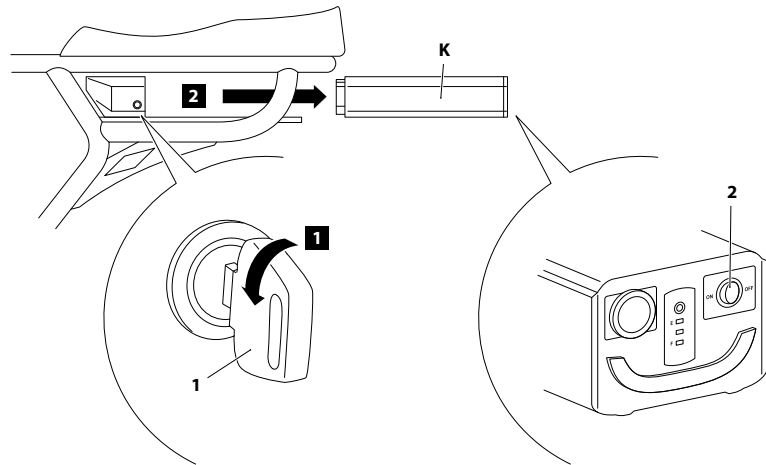

4.1.4 STORING THE BATTERY

- Batteries should be stored at temperatures between 4 °C and 27 °C (40 °F and 80 °F) for maximum life and safety. Higher storage temperatures increase the self-discharge rate from the nominal 1-2% per month to as high as 35% per month, and can reduce battery life and increase the possibility of catastrophic failure with long term high temperature storage. Never store batteries at temperatures higher than 76°C (170 °F).
- Batteries may be stored at 100% charge if used frequently. However, for maximum life, batteries that are not used frequently should be stored at 40% to 70% charge. An easy way to bring a discharged battery into the proper long-term storage charge is to charge for about 60 minutes with the supplied charger. Batteries in long-term storage at room temperature should receive a refresh charge every three months or so.

4.1.5 BATTERY STATUS LEDS

1. Press the power button on the battery:
 - a. If none of the battery status LEDs lights up: The battery is damaged. Do NOT charge the battery. If within 2 years of purchase, contact the retailer from where you purchased your Knaap Bike (www.knaapbikes.com).
 - b. If 3 LEDs are lit: The battery is fully charged.
 - c. If 0 LEDs are lit: The battery is empty.

BATTERY STATUS LEDS/POWER LED

SIGNAL

BATTERY CHARGE LEVEL

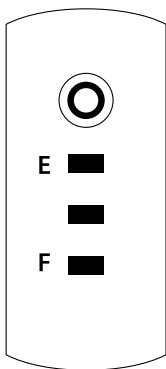

3 LEDs lit
0 LEDs lit

Full
Empty

NOTICE

The battery status is also shown on the LCD display. See [4.3.3.1 Battery power level](#) for more information.

4.2 USING THE BRAKES

NOTICE

- For the UK: The rider's left brake is the rear brake and the rider's right brake is the front brake.
- For the EU: The rider's right brake is the rear brake and the rider's left brake is the front brake.

▲ WARNING

Risk of injury. There is a risk of falling over the handlebar when you only use the front brake. Hand brakes must always be used simultaneously.

- For the EU:
 - Squeeze the **left brake** to stop the front wheel.
 - Squeeze the **right brake** to stop the rear wheel.
- For the UK :
 - Squeeze the **right brake** to stop the front wheel.
 - Squeeze the **left brake** to stop the rear wheel.

4.3 SPEED CONTROL SYSTEM (WITH LCD DISPLAY)

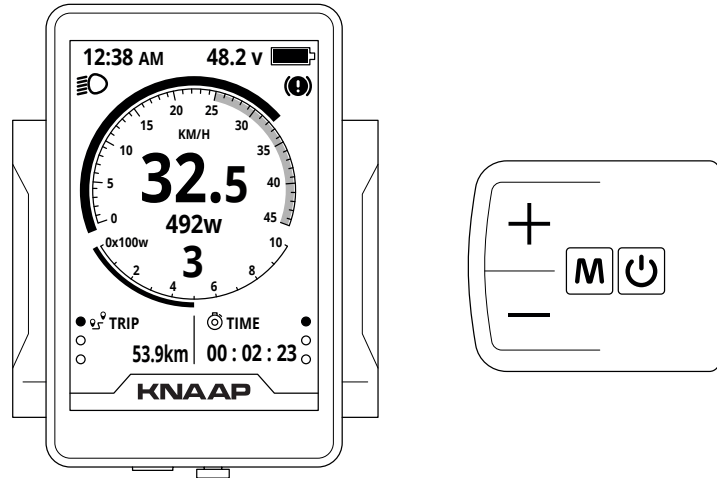

The Knaap bike comes with a speed control system (LCD display and speed controller). The speed control system is connected to the rear hub motor and the pedal assist sensor located on the driver-side crank arm. When you start pedalling, the pedal assist sensor detects the forward pedal rotation and after two rotations activates the motor to power your ride. The setting on the LCD display determines how much power the motor uses to assist your pedalling.

You can set five pedal assist levels (default setting): Level 0 provides no assist, level 1 is the lowest level of assist and level 5 is the highest. If you just want a little push, or if you want to extend your battery range, level 1 or 2 is recommended.

See *4.3.4 USING THE PEDAL ASSIST* for more information on how to use the pedal assist. See *4.3.9.4 BASIC SETTINGS - ADVANCE SETTING* for more information on how to change the number of pedal assist levels.

4.3.1 ADJUSTING THE ANGLES OF THE LCD DISPLAY AND SPEED CONTROLLER

NOTICE

- Do not connect or disconnect the LCD display when the LCD display is switched on.
- The LCD display is fragile. Avoid rough riding conditions and collisions.
- The LCD display can be used between -20°C to $\sim +70^{\circ}\text{C}$.
- The LCD display and the speed controller are IP65 (water proof).

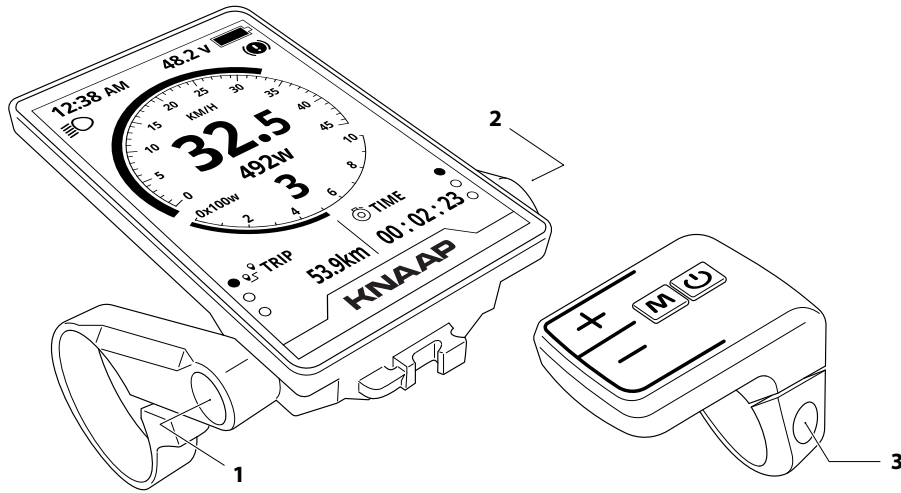

1. Loosen the screws ① and ② of the LCD Display.
2. Put the LCD display in the correct position.
3. Tighten the screws.
4. Loosen the screw ③ of the speed controller.
5. Put the speed controller in the correct position.
6. Tighten the screw.

When tightening the screws pay attention to the below torque values. Tightening above these values can cause damage.

- LCD display: M3*10 - standard torque of 0.50 Nm
- Speed controller: M3*10 - standard torque of 0.25 Nm (max. 0.4 Nm)

4.3.2 SWITCHING THE LCD DISPLAY ON AND OFF

1. Make sure that the  button ① of the battery is in the **ON** position.

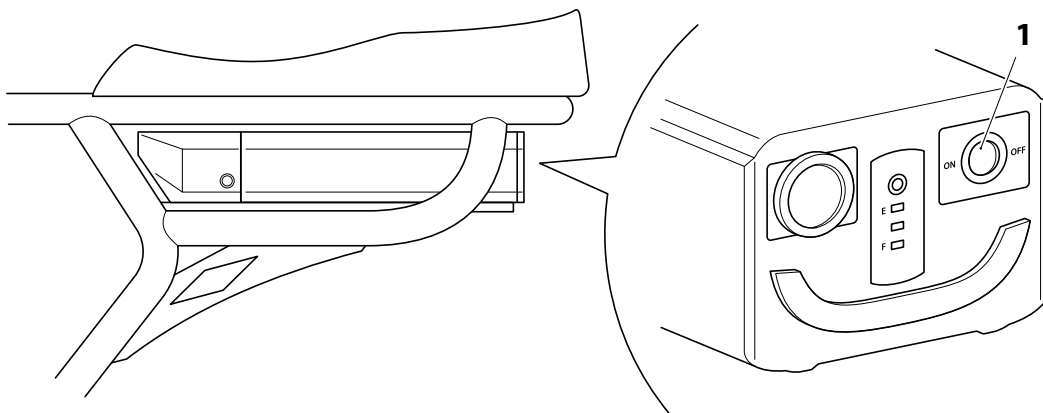

2. Press and hold the  button ② of the **speed controller** for 1 second.

The LCD display lights up and the **main screen** opens.

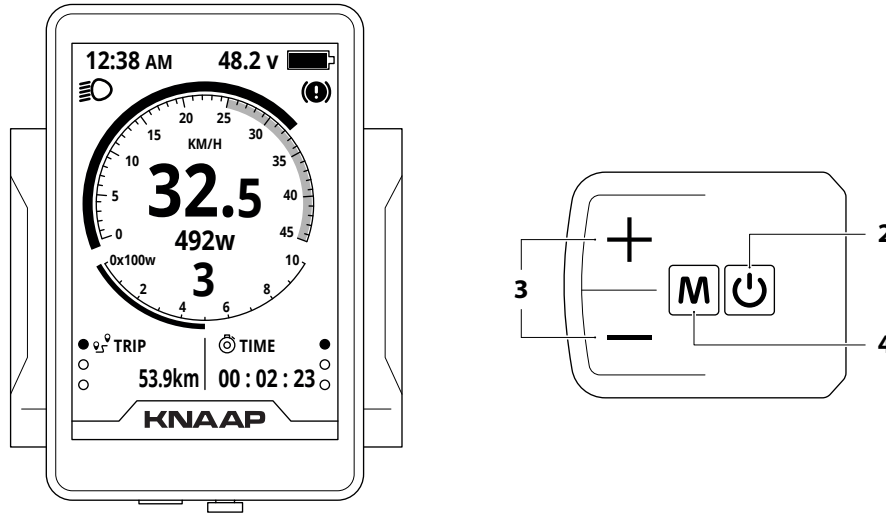

If a password has been set (see 4.3.9.3 DISPLAY SETTINGS - START PASSWORD) then you must enter the correct password before the LCD display will show the main screen. When a wrong password is entered, the LCD display will switch off.

NOTICE

3. To switch the LCD display off, press the  button on the speed controller again.

NOTICE

The LCD display switches off automatically after 5 minutes of inactivity (this is the default setting, see 4.3.9.3 *DISPLAY SETTINGS - AUTO OFF* to change this time).

4.3.3 OVERVIEW OF THE MAIN SCREEN

Once the LCD display has been switched on, it will show the main screen.

To change the unit of measurement (metric or imperial) and several other settings, see 4.3.9.3 *DISPLAY SETTINGS*.

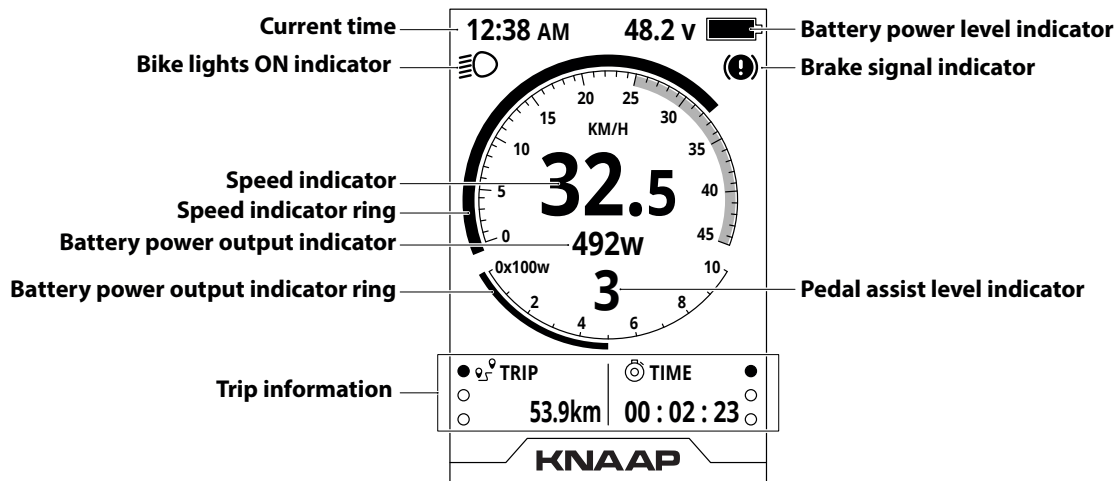

The main screen

4.3.3.1 BATTERY POWER LEVEL



The battery power level indicator (see illustration *The main screen*) shows the power status of the bike battery.

NOTICE

- The battery power level indicator flashes weakly in case of low battery power.
- See 4.3.9.3 *DISPLAY SETTINGS – BATTERY INDICATION* to change the indication on the left of the battery icon to Voltage, Percentage or OFF.

4.3.3.2 CHANGING THE TRIP INFORMATION

The trip information (see illustration *The main screen*) can show the following information: TRIP, ODO, RANGE, TIME, MAX SPEED and AVERAGE SPEED.

1. Press the  **button** on the speed controller to switch on the **LCD display**.
2. Press the  **button**  to change to the next trip information. The different trip informations appear in this order:

TRIP -> ODO -> RANGE -> TRIP -> TIME -> MAX SPD -> AVG SPD

NOTICE

- **After 5 seconds, the trip information goes back to the default view of TRIP and TIME.**
- **Smart BMS support is needed to show the range.**

3. Press and hold the **+** button and **-** button ③ for 1 second to reset the temporary data such as AVG SPD, MAX SPD, TRIP and TIME.

Switching the LCD display off does not reset the temporary data.

4.3.4 USING THE PEDAL ASSIST

1. Make sure that the **ON/OFF** button ① of the battery is in the **ON** position.

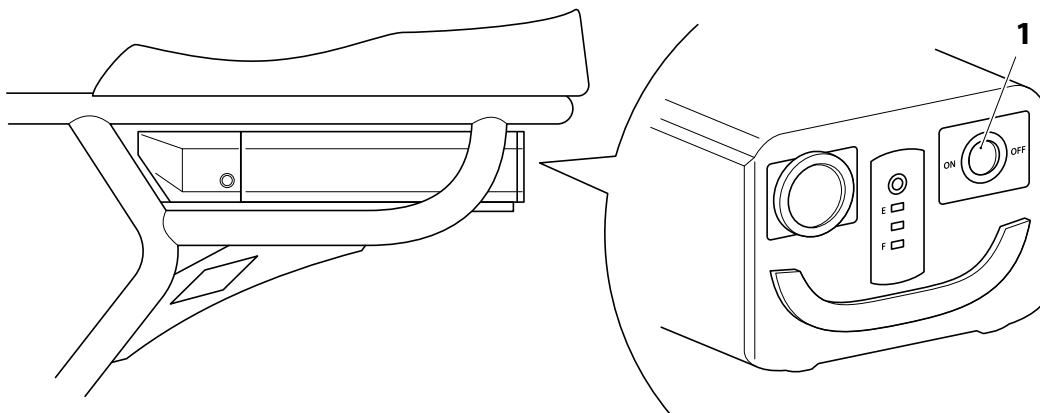

2. Press and hold the **ON/OFF** button of the **speed controller** for 1 second to switch on the LCD display.

3. Use the  button and  button until you reach the **level of pedal assist** you want.

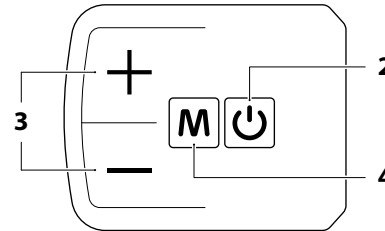
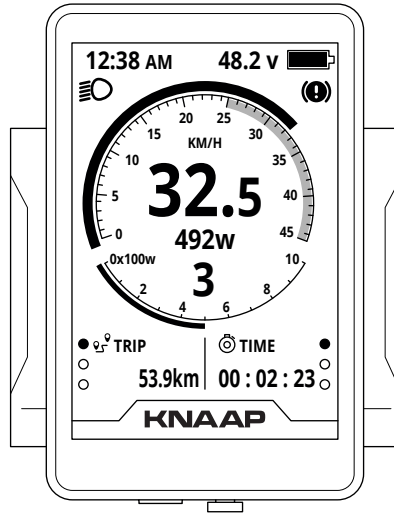



4. Start or continue pedaling. The rear hub motor starts providing the level of electrical power you selected at the **second rotation** of the pedals.
5. When you have selected the level of pedal assist, press and hold the  button of the **speed controller** to switch off the LCD display.

NOTICE

The number of pedal assist levels can be set in the Menu, see **4.3.9.4 BASIC SETTINGS - ADVANCE SETTING**. Available options are 3, 5 and 9 levels.

4.3.5 SWITCHING THE REAR AND FRONT LIGHT ON/OFF



1. Press and hold the  **button** to switch on the rear light and the front light of the bike. When the lights are switched on you will see a light icon on the LCD display.
2. Press and hold the  **button** again to switch off the rear light and the front light of the bike.

NOTICE

- When the battery of the bike is at 0,05% power, the motor stops working to make sure the bike lights can still be powered for a while when riding.
- When the bike lights are switched on, the LCD display switches to night mode.
- In the menu there is an option to switch on the light sensor. This will automatically turn the bike lights on and off (see **4.3.9.4 BASIC SETTINGS - LIGHT SENSOR**).

4.3.6 USING THE WALK ASSIST MODE

This function is intended for walking alongside the bike with more ease.
The walk assist function cannot be used while riding the bike.

1. Press and hold the  **button** for 2 seconds to activate the walk assist mode.
The pedal assist level indicator shows the letter **P** when the walk assist mode is active.
As long as you keep pressing the  **button** the motor will drive the bicycle at 6 km/h.
2. Release the  **button** and the walk assist mode is deactivated.

4.3.7 USING THE USB PORT

The LCD display is equipped with a USB port on the bottom panel. It has an output of 5V/500mA that can be used to power an external device. The USB port can be switched on and off in the menu (see 4.3.9.4 *BASIC SETTINGS - USB PORT*).

4.3.8 CHARGING THE BATTERY OF THE LCD DISPLAY

There is a rechargeable battery inside the LCD display to supply power to the clock and store the settings when the LCD display is switched off. This battery is charged by the external power from the bike battery when the LCD display is on. The battery has a life-time of 100-120 days before it needs to be recharged.

In case the battery is empty after a long period of not using the LCD display, charge the internal battery according to the following instructions:

1. Go into the menu and set **Auto off** to **OFF** (see 4.3.9.3 *DISPLAY SETTINGS - AUTO OFF*).
This ensures the LCD display will not switch off automatically.

2. Keep the LCD display switched on for 72 hours and the internal battery will be charged.
3. Go into the menu and set **Auto off** to **ON**.

This will switch off the LCD display automatically again.

4.3.9 CHANGING THE SYSTEM SETTINGS

The menu allows for changing certain information on the main screen like metric units and battery power level indications, setting basics such as wheel size and battery voltage and provides information on the bike battery details and error codes.

NOTICE



- Some settings may not have an alternative option, this is not a defect.
- For safety reasons you can not go into the menu while riding the bike.
- When you start riding the bike, the menu is closed and the main screen opens.
- The menu is automatically closed after 30 seconds of inactivity.

The menu is divided into 2 sections.







- **Display settings** (affecting the main screen)
 - a. **LANGUAGE**
 - b. **SYSTEM**

- c. BRIGHTNESS
 - d. AUTO OFF
 - e. SCENES
 - f. BATTERY INDICATION
 - g. POWER INDICATION
 - h. CLOCK
 - i. START PASSWORD
- **Basic settings** (system parameters, factory reset and informations)
 - a. WHEEL
 - b. BATTERY
 - c. USB PORT
 - d. LIGHT SENSOR
 - e. ADVANCE SETTING
 - CHANGING THE SPEED LIMIT
 - CHANGING THE ASSIST LEVELS
 - ERROR CODE
 - f. FACTORY SETTINGS
 - g. INFORMATIONS









4.3.9.1 OPENING THE MENU













1. Press the  **button** of the speed controller to switch the LCD display **ON**.
2. Press the  **button** two times with less than 0.3 seconds in between the button presses.
The **MENU** page opens.







4.3.9.2 NAVIGATING IN THE MENU











1. Use the  **and**  **buttons** to go up and down in the menu pages.
2. Press the  **button** to select a setting.
3. Use the  **and**  **buttons** to select an option.
4. Press the  **button** to store your selection.
5. Press the  **button** two times to exit the menu.

4.3.9.3 DISPLAY SETTINGS

SETTING	EXPLANATION	INSTRUCTIONS
LANGUAGE	The default language is English. This can not be changed.	-
SYSTEM	Changes the unit system between Metric (km/h) and Imperial (mph).	<ol style="list-style-type: none"> 1. Navigate to SYSTEM. 2. Press the  button. 3. Press the  button or  button to select Metric (kmh) or Imperial (mph). 4. Press the  button to save your selection.
BRIGHTNESS	<p>Changes the brightness of the LCD display in 5 steps. The default brightness is 1.</p> <p>NOTICE</p> <p>When the lights of the bike are switched on, the LCD display automatically switches to night mode. The brightness can be set separately for day and night mode.</p>	<ol style="list-style-type: none"> 1. Navigate to BRIGHTNESS. 2. Press the  button. 3. Press the  button or  button to decrease or increase the brightness of the LCD display. 4. Press the  button to save your selection.

SETTING	EXPLANATION	INSTRUCTIONS
AUTO OFF	Changes the time for the LCD display to switch off after not being used. The time can be set from 1 to 9 minutes or OFF. The default setting is 5 minutes.	<ol style="list-style-type: none"> 1. Navigate to AUTO OFF. 2. Press the  button. 3. Press the  button or  button to select a different timing (1 to 9 min or OFF). 4. Press the  button to save your selection.
SCENES	The default scene is ANALOG. This can not be changed.	-
BATTERY INDICATION	Changes the battery power level indicator on the left of the battery icon to Voltage, Percentage or OFF.	<ol style="list-style-type: none"> 1. Navigate to BATTERY IND. 2. Press the  button. 3. Press the  button or  button to select Voltage, Percentage or OFF. 4. Press the  button to save your selection.
POWER INDICATION	Changes the battery power output indicators to Power or Current.	<ol style="list-style-type: none"> 1. Navigate to POW IND. 2. Press the  button. 3. Press the  button or  button to select Power or Current. 4. Press the  button to save your selection.









SETTING	EXPLANATION	INSTRUCTIONS
CLOCK	Changes the time and date settings.	<ol style="list-style-type: none">1. Navigate to CLOCK.2. Press the  button. The Display Setting Clock page opens.3. Navigate to the setting that needs to be changed.4. Press the  button to select this setting.5. Press the  button or  button to change the number.6. Press the  button to save your selection.7. Repeat steps 3 to 6 until all the Time and Date settings are correct.8. Navigate to BACK9. Push the  button to go back to the menu.















SETTING	EXPLANATION	INSTRUCTIONS
<p>START PASSWORD</p>	<p>You can set a password to prevent the LCD display from being switched on by an unauthorized individual.</p> <p>NOTICE</p> <p>When setting the Start Input to ON you have to enter the correct password when switching on the LCD display. Make sure to remember the password that is set. The default password is 0000.</p>	<ol style="list-style-type: none"> Navigate to START PASSWORD. Press the  button. The Input Password page opens. <p>ACTIVATING THE PASSWORD</p> <ol style="list-style-type: none"> Navigate to Start Input. Press the  button. Use the  button or  button to select ON or OFF. Press the  button to save your selection. <p>SETTING THE PASSWORD</p> <ol style="list-style-type: none"> Navigate to Setting Password. Press the  button. The first digit will start to flash. Use the  button or  button to change the first digit. Press the  button to save your selection. The next digit will start to flash. Repeat step 9 and 10 until all digits are set. Navigate to BACK. Press the  button to go back to the menu.











4.3.9.4 BASIC SETTINGS









In order to see the **Basic Settings**







1. Navigate to ●●●
2. Press the  **button** to show all the settings.

SETTING	EXPLANATION	INSTRUCTION
WHEEL	<p>Allows to set the wheel diameter so it matches your bike's wheel diameter.</p> <p>Available options are 16/18/20/22/24/26/27/27.5/28/29/30/31 inch</p>	<ol style="list-style-type: none"> 1. Navigate to Wheel. 2. Press the  button. 3. Press the  button or the  button to change the wheel size. 4. Press the  button to save your selection.
BATTERY	<p>Allows to set the correct bike battery voltage.</p> <p>Available options are 24V, 36V, 48V and 52V.</p> <p>NOTICE</p> <p>If the selected voltage does not match your bike's battery, wrong information will be displayed.</p>	<ol style="list-style-type: none"> 1. Navigate to Battery. 2. Press the  button. 3. Press the  button or the  button and select the voltage that matches with your bike's battery voltage. 4. Press the  button to save your selection.

SETTING	EXPLANATION	INSTRUCTION
USB PORT	The LCD display is equipped with a USB port with an output of 5V/500mA that can be switched on and off.	<ol style="list-style-type: none"> 1. Navigate to USB Port. 2. Press the  button. 3. Press the  button or  button to select ON or OFF. 4. Press the  button to save your selection.
LIGHT SENSOR	<p>The light sensor automatically switches the bike's lights on and off.</p> <p>The light sensor can be switched on or off.</p> <p>The sensitivity of the light sensor can be adjusted.</p>	<ol style="list-style-type: none"> 1. Navigate to Light sensor. 2. Press the  button. The Light Sensor page opens. <p>SWITCHING THE SENSOR ON OR OFF</p> <ol style="list-style-type: none"> 3. Navigate to Sensor. 4. Press the  button. 5. Press the  button or  button to select ON or OFF. 6. Press the  button to save your selection. <p>SETTING THE SENSITIVITY</p> <ol style="list-style-type: none"> 7. Navigate to Sensitivity. 8. Press the  button. 9. Press the  button or  button to select HI, MID or LOW. 10. Press the  button to save your selection. 11. Navigate to BACK. 12. Press the  button to go back to the menu.

SETTING	EXPLANATION	INSTRUCTION
ADVANCE SETTING:	The advance setting is protected with a password.	<ol style="list-style-type: none"> 1. Navigate to Advance setting. 2. Press the  button. The Advance Setting Password page opens. 3. Navigate to Input Password. 4. Press the  button. The first digit starts to flash. 5. Press the  button or  button to input the first digit of the password. 6. Press the  button to store your selection. 7. Repeat step 5 and 6 until the correct password has been input. 8. After the last digit is selected press the  button. The Advance setting page opens.
SPEED LIMIT	<p>NOTICE</p> <p>The default password is 1919.</p>	
PEDAL ASSIST LEVELS	In the advance settings it is possible to	
ERROR CODE	<ul style="list-style-type: none"> - change the speed limit. The speed limit can be set within the range of 10km/h-60km/h or 99/kmh (unlimited). The default speed limit value is 25 km/h. The Speed limit and current limit are restricted by the controller and the motor. 	<p>SPEED LIMIT</p> <ol style="list-style-type: none"> 9. Navigate to Speed limit. 10. Press the  button. 11. Press the  button or  button to set the speed limit. 12. Press the  button to store your selection.

SETTING	EXPLANATION	INSTRUCTION
	<ul style="list-style-type: none"> change the pedal assist levels. Available options are 3, 5 and 9 levels of Pedal assist or UBE (factory default setting). see the last 10 error codes. For the list of error codes see <i>4.4.9.5 ERROR CODES</i> 	<p>ASSIST LEVELS</p> <ol style="list-style-type: none"> Navigate to Assist levels. Press the  button. Press the  button or  button to select the amount of levels. Press the  button to store your selection. Navigate to BACK Press the  button to go back to the menu Navigate to EXIT Press the  button to close the Menu and go back to the main screen.
FACTORY SETTINGS	This setting allows you to reset all the settings in the menu to the factory settings.	<ol style="list-style-type: none"> Navigate to Factory settings. Press the  button. The Restore Factory Settings page opens. Navigate to YES. Press the  button to reset and restore the factory settings. Navigate to BACK. Press the  button to go back to the menu.

SETTING	EXPLANATION	INSTRUCTION
<p>INFORMATIONS</p>	<p>Shows Speed and Mileage information and gives access to two more information pages (Product and Battery)</p> <p>Product information Shows information regarding the LCD display.</p> <p>Battery information Shows information regarding the Battery status.</p> <p>NOTICE The battery information needs to be supported by battery communication.</p>	<ol style="list-style-type: none"> 1. Navigate to Informations. 2. Press the  button. The Information page opens showing Speed and Mileage. 3. Navigate to BACK. 4. Press the  button to go back to the menu. <p>PRODUCT INFORMATION</p> <ol style="list-style-type: none"> 5. Navigate to Product Infor. 6. Press the  button. The Product Information page opens. 7. Navigate to EXIT. 8. Press the  button to go back to the main screen. <p>BATTERY INFORMATION</p> <ol style="list-style-type: none"> 9. Navigate to Battery infor. 10. Press the  button. The Battery Information page opens. 11. Navigate to NEXT PAGE 12. Press the  button. 13. Navigate to EXIT 14. Press the  button to go back to the main screen.

4.4.9.5 ERROR CODES

In the event of an error, the motor will stop and an error code will appear at the location of the KNAAP logo on the main screen. Once the error is solved, the motor starts working again.

ERROR CODE	DESCRIPTION	ERROR DISPLAYED
04	Throttle on high position	04H
05	Throttle error	05H
07	High voltage protection	07H
08	Motor's HALL sensor error	08H
09	Phase line of motor error	09H
10	Controller over temperature	10H
11	Motor over temperature	11H
12	Current sensor error	12H
13	Battery's temperature sensor error	13H
14	Motor's temperature sensor error	14H
15	Controller's temperature sensor error	15H

21	Speed sensor error	21H
22	BMS communication error	22H
23	Headlight error	23H
24	Headlight sensor error	24H
25	Torque sensor error - Torque	25H
26	Torque sensor error - Speed	26H
30	Communication error	30H

4.4 USING THE GEAR SHIFTER

The Knaap bike has a 7-gear shifter, so you can pedal comfortably no matter what the terrain. Use an easier gear (1 is the easiest) on hills or when you're riding into the wind. Use a harder gear (7 is the hardest) on flats or if the wind is blowing from behind. When you shift, keep pedalling but ease up on the pedals, especially on hills. If you are pushing hard or if you stop pedalling completely, the chain can skip or fall off.

1. Press the **gear up button** ① to shift into an easier gear.
2. Press the **gear down lever** ② to shift into a harder gear.

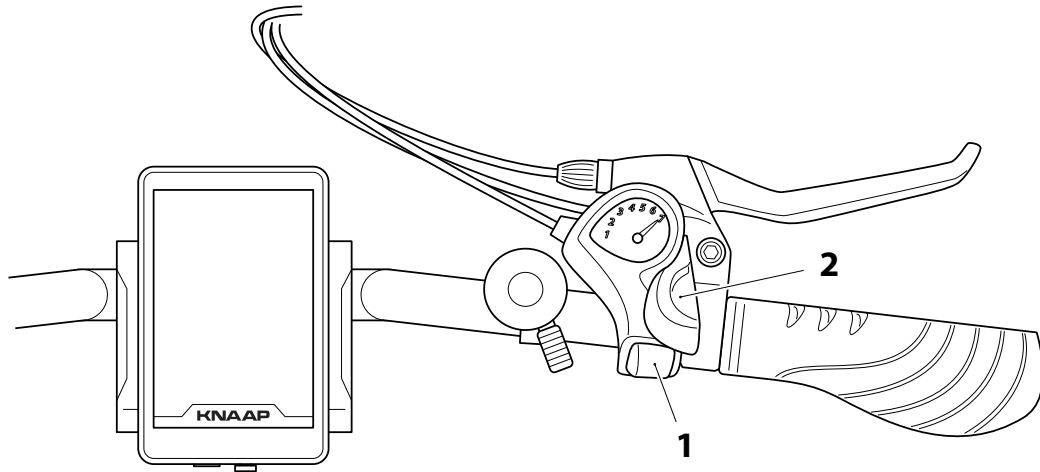

TIP

- For smoother shifting, pedal lightly while using the **gear shifter**. Do not backpedal.
- If you are pedalling too fast, and there is not enough resistance, shift into a harder gear. You will also go faster.
- If you are pedalling too slow, and it is hard to turn over the pedals, try shifting into an easier gear.



4.5 USING THE LIGHTING SYSTEM

4.5.1 FRONT LIGHT AND REAR LIGHT

1. Make sure that the **battery** and the **LCD display** are switched on.
2. Press the  **button** to switch on the lights.
3. Press the  **button** to switch off the lights.

4.5.2 REFLECTORS

The bike has three types of reflectors:

- Reflectors attached to the wheels
- Reflectors on the pedals
- Reflector on the back side of the battery

4.6 RECOMMENDATIONS FOR FIRST-TIME EBIKE RIDERS

4.6.1 GETTING ACQUAINTED WITH THE BIKE

Take some time to familiarize yourself with the Knaap bike and its special features. First make sure that you read and understand the user instructions, then go for a ride! The following safety aspects in particular must be considered:

- Given the comparatively high speed, a correct braking technique is essential. So test your brakes and how to brake on a parking lot for example, before you start riding in traffic.
- To ensure a good travelling range and stability when going round bends, your tires must be in a good condition and have the correct pressure. Check the sidewall of your tires for the minimum and maximum pressure recommended. Take into account the weight of the drive unit and the battery when pumping up the tires.
- The Knaap bike is powered by a 36 V, 21 Ah lithium-ion battery. The battery is a critical component and one of the most expensive components to replace. Make sure that you follow our recommendations to maximize the service life of your battery. See *section 4.1 Using the battery*.

4.6.2 MECHANICAL SAFETY CHECK BEFORE RIDING

TASK	INSTRUCTIONS
<p>Check for loose nuts and bolts</p>	<ol style="list-style-type: none"> 1. Straddle the bike and lift the front wheel approximately 5 cm (3 inches) off the ground. 2. Release the bike and allow the front wheel to drop and bounce. 3. Listen for any rattling: This may indicate that some parts are loose. 4. Repeat the same process for the rear wheel. 5. Tighten any loose nuts and bolts. Do not forget to check the foot rests, and the park stand.
<p>Checking the wheel and tires</p>	<ol style="list-style-type: none"> 1. Make sure that the tires are inflated to the required pressure and in good condition. The required pressure is stated on the tire. Take into account the weight of the drive motor and the battery. 2. Slowly rotate each wheel: <ol style="list-style-type: none"> a. Inspect the side walls and threads of the tire. Look out for cracks and objects that may be stuck in the outer layer. b. If the wheel wobbles or appears to be off-center, your wheel must be trued. Consult a skilled technician. c. Check the rims. Damage to the rim causes weak spots and can result in a faulty wheel over time.

TASK	INSTRUCTIONS
Check the brakes	<p>EU: The rider's right brake is the rear brake and the rider's left brake is the front brake. UK: The rider's left brake is the rear brake and the rider's right brake is the front brake.</p> <ol style="list-style-type: none"> 1. While stationary: Squeeze each brake lever to make sure that there is resistance. 2. If there is no resistance: Contact your local dealer.
Check the handlebar grips	<p>Check for cracks, cuts or signs of wear: These can all have an impact on how the grip is fitted onto the handlebars. Loosely fitted handlebar grips can slip off, potentially resulting in loss of control and falling.</p>
Check the battery	<ol style="list-style-type: none"> 1. Make sure that the battery is securely connected and locked to the bike. 2. Check the battery charge status.
Checking the cables	<p>Check the exposed cables for cracks, cuts or signs or wear.</p>

5 MAINTENANCE

In order to keep your bike in a good shape it must be inspected and maintained at regular intervals. This can be done either by yourself or a skilled technician. Also make sure that you clean your bike regularly. It doesn't take long and it gives you the chance to spot any faults before they develop into anything serious.

▲ CAUTION

Before you carry out any maintenance tasks:

- **ALWAYS** remove the battery. Make sure that the ON/OFF button of the battery is in the OFF position before moving the battery.
- **ALWAYS** make sure that the cables are in a good condition:
 - **NEVER** bend cables beyond their bending radius.
 - **ALWAYS** make sure that the cables are routed and connected correctly.
 - **ALWAYS** make sure that the cables do not have any signs of damage, such as pinching, nicks, crushing, exposed conductors, punctures or thinning.
- **NEVER** touch the brakes or the rotor during or immediately after use. These can get very hot and cause injuries.
- **ALWAYS** avoid lubricant, degreaser and brake fluid getting on the rotor or the brake pads. Never touch these components with your bare hand.
- **ALWAYS** check the mechanical components subject to wear and tear. Cracks, scratches or color change in highly stressed areas indicate that the part has reached the end of its useful life and must be replaced.

5.1 CLEANING THE BIKE

If you clean your bike regularly, you are more likely to detect weak spots that might develop into a serious issue later.

NOTICE

Risk of damage. Do NOT use a high pressure cleaner. Water coming from a high-pressure hose can cause damage to the bearings of your bike. Water can also get into the electrical wiring, which can lead to short-circuits in the electrical system.

1. Ideally the bike should be put in a work stand.
2. Make sure that the **ON/OFF button** of the battery is in the OFF position.
3. Remove the **battery** Ⓜ from the bike. See *section 4.1.3 Removing the battery*. You may also want to remove the **LCD console** Ⓜ.
4. If the bike is very dirty: Carefully wash off the bike with a garden hose first.
5. Degrease the chain:
 - a. Soak a clean rag with degreaser.
 - b. Make sure that the degreaser gets on every link: Backpedal while you grasp the chain with the rag. The dirt will come off the chain.
 - c. Repeat until the chain is clean.

- d. Dry the chain.
- 6.** Clean the drivetrain:
- a. Use a clean rag to clean between chainrings, cogs and other hard-to-reach parts.
 - b. Scrub the chainrings. Use a brush to get into the hard-to-reach parts.
 - c. Rinse with a gentle stream of water.
 - d. Moisten the cassette with water with bike cleaner and scrub it clean.
 - e. Rinse with a gentle stream of water.
- 7.** Clean the frame:
- a. Wash off the frame with a sponge moistened in water with bike cleaner.
 - b. Clean the brake pads.
- 8.** Clean the wheels:
- a. Wash off each wheel with a brush moistened in water with bike cleaner.
 - b. Clean the area around the valve, scrub all the way around the wheel, clean the spokes and the wheel hub.
 - c. Repeat this process for the other wheel.
- 9.** Wash off the bike with clean water.
- 10.** Wipe everything dry with a dry clean cloth or let your bike air-dry in the sun.
- 11.** Lubricate the chain of the bike. See *section 5.3 Lubricating the bike*.

12. Clean the break discs:

- a. Use a brake cleaner and spray onto the left and right side of the Front and Rear brake disc.
- b. Use a clean, dry hydrophilic cloth and wipe the brake disc on the left and right side to remove any remaining moisture or dirt.

Repeat steps a and b if necessary.

⚠ WARNING

Make sure the brake discs and brake pads are never in contact with any oil or other lubricants. Oil or lubricants affect the brake's functioning and can lead to dangerous situations.

5.2 ADJUSTING THE CHAIN TENSION

TOOLS/MATERIALS REQUIRED

Knaap toolkit

1. Put your bike on a bike stand. The wheels should be up in the air; otherwise it is difficult to tighten the bike chain.

2. Carefully loosen the axle nuts that are holding your rear wheel onto the bike. This loosens the rear wheel, allowing you to adjust the tension on the chain.
3. Carefully pull back on the rear wheel. This increases the tension on the chain.
4. Check whether the tension is correct: The maximum play allowed when moving the chain is 1 cm or half an inch in either direction.
5. If you the chain has more play than 1 cm / 0.5 inch in either direction: Pull back on the rear tire a bit more.
6. When you reached the ideal chain tension: Tighten the axle nuts one by one.
7. Make sure that the wheel is correctly installed on the bike.

CAUTION

While tightening the rear axle nuts: Always check the rear wheel position. The rear wheel must never touch the chain or the bike frame.

8. If you feel that the tension of the chain is still not adjusted properly, you may need to adjust the B screw. Contact a skilled technician for assistance, if needed.

5.3 LUBRICATING THE BIKE

Tools/Material required:

- Bike lubricant (not included)
- Silicone cleaning spray (not included)
- All season chain oil (not included)

1. Ideally the bike should be put in a work stand.
2. Make sure that the bike is clean and that the drive chain is degreased. See *section 5.1 Cleaning the bike*.

LUBRICATION POINT

INSTRUCTION

Chain

1. Put a drop of lubricant on each link, while you backpedal slowly for a few rotations.
2. Wipe off the excess of lubricant.

TIP: Not wiping off the excess of lubricant attracts more dirt to the chain. Never use motor oil.

LUBRICATION POINT

INSTRUCTION

Rear shift cable:

1. Shift the gears until the chain is on the largest sprocket, and then stop the wheel from rotating.
2. Shift your shifter all the way in the opposite direction, as if you were going to shift to the smallest sprocket.
3. The rear derailleur should now be stuck on the largest sprocket. This will give you enough slack to fully release the cable from the frame.
4. Pull the upper section of the outer cable down leaving a section of inner cable exposed.
5. Carefully put a few drops of lubricant onto the inner cable just where it runs down into the housing.
6. Reconnect the outer housing.
7. Pull the lower section of the housing free from the frame, and slide it away from the derailleur.
8. Repeat the lubrication process and reconnect the housing.
9. Don't forget to move your rear shifter back to the largest sprocket before rotating the rear wheel.

LUBRICATION POINT	INSTRUCTION
Pivot points	<ol style="list-style-type: none"> 1. Drip lubricant onto each pivot point: <ul style="list-style-type: none"> • rear derailleur 2. Wipe off any excess of lubrication so it doesn't attract dirt. <p>TIP: Lubricate the pivot points every few months, especially if you ride in wet weather conditions.</p>
Derailleur pulleys	<ol style="list-style-type: none"> 1. Wipe off the grime from your derailleur pulleys with a clean rag and degreaser. 2. Then apply a small drop of lubricant to the bearings at the center of the pulley. 3. Backpedal a few revolutions. 4. Use a clean rag to wipe off any excess of lubrication. <p>NOTICE Never use grease.</p>

5.4 MAINTENANCE SCHEDULE

EVERY RIDE	MONTHLY 500 KM / 600 MI	SIX MONTHS 1,500 / 930 MI	YEARLY 4,500 KM / 2,800 MI
Check your tire pressure and inflate as needed. The required pressure is marked on the side wall of the tyre.	Clean your bike (see section 5.1 <i>Cleaning the bike</i>) and inspect the frame/components for cracks and wear.	Clean your bike (see section 5.1 <i>Cleaning the bike</i>) and inspect the frame/components for cracks and wear.	Inspect the pedals, add fresh grease, and check the bearings.
Check your tires for debris, thorns, etc. These can cause a flat.	Check the tightness of the crank arms, pedals, chainring bolts, stem/handlebar bolts, and any other mounting bolts.	Check the tires for wear and replace as needed.	Check the tires for wear and replace as needed.
Make sure that the axle nuts on the wheels are tight and secure.	Check all cables and cable housings for wear, kinks, rust and fraying. Replace as needed and lubricate good cables/housing at entry/exit points.	Check the bearing systems (hubs, bottom bracket, headset) for play and/or grinding and grumbling. Replace or adjust as needed.	Check the bearing systems (hubs, bottom bracket, headset) for play and/or grinding and grumbling. Replace or adjust as needed.

EVERY RIDE	MONTHLY 500 KM / 600 MI	SIX MONTHS 1,500 / 930 MI	YEARLY 4,500 KM / 2,800 MI
<p>Lifting the front and rear of the bike, spin each wheel while looking for wobbles and rim damage. Wobbly wheels should be centered by a skilled technician.</p>	<p>Check the wheels for loose or damaged spokes.</p>	<p>Check the brake pads for wear and replace as needed. Also check for worn grips and replace as needed.</p>	<p>Check the brake pads for wear and replace as needed. Also check for worn grips and replace as needed.</p>
<p>Check your brake pads for wear and make sure that they are making firm contact with either the rim or the brake disc.</p>	<p>Maintain, lubricate, and service your suspension components.</p>	<p>Check all cables and cable housing for wear, kinks, rust and fraying. Replace as needed and lubricate good cables/housing at entry/exit points.</p>	<p>Check all cables and cable housing for wear, kinks, rust and fraying. Replace as needed and lubricate good cables/housing at entry/exit points.</p>

EVERY RIDE	MONTHLY 500 KM / 600 MI	SIX MONTHS 1,500 / 930 MI	YEARLY 4,500 KM / 2,800 MI
<p>Check the suspension fork (and shock) and the rear shock for compression and release, and make sure that there is no flex or play in the suspension.</p>		<p>Check the cassette and the chainrings for wear; check the chain for wear, tight links, and bent links. Also check the derailleur cage for damage. Replace drivetrain parts as needed.</p>	<p>Maintain, lubricate, and service your suspension components.</p>
<p>Check the chain for cleanliness. Clean if dirty, lubricate if dry.</p>		<p>Maintain, lubricate, and service your suspension components.</p>	

5.5 TORQUE SETTINGS

The following table shows the torque settings for the bolts of the Knaap bike.

Caliper mounting bolts	68 Nm
Crank bolts	46 Nm
Gear shifter nuts	4 Nm
Mudguard bracket nuts	8 Nm
Rear wheel axle nut	35 - 45 Nm
Handlebar clamp nuts	5 - 6 Nm
Brake lever nuts	10 - 12 Nm
All other nuts	Check the nut diameter: <ul style="list-style-type: none">• M4: 2.5 - 4.0 Nm• M5: 4.0 - 6.0 Nm• M6: 6.0 - 7.5 Nm

6 TRANSPORT AND STORAGE

6.1 TRANSPORTING THE BIKE AND THE BATTERY

⚠ CAUTION

Risk of damage. Due to its size, shape and weight we do not recommend carrying the bike on the roof of a passenger car.

⚠ DANGER

Risk of fire. Appropriate measures must be taken when transporting the battery.

6.1.1 TRANSPORTING THE BIKE

1. Make sure that the **ON/OFF button** of the battery is in the **OFF** position.
2. Remove the **battery**  from the bike. See *section 4.1.3 Removing the battery*.
3. If you are shipping the bike by plane, boat, truck or train:
 - a. Choose the shipping container: cardboard box, soft shell case or hard shell case.
 - b. Disassemble the bike.
 - c. Wrap the fragile pieces, such as the derailleur, the lighting and the pedals in a protective cover.

- d. Put the bike components in the shipping container.
- e. Shake the shipping container and listen for any rattling noise. If you hear a rattling sound, review your work.

4. Arrange for the bike to be picked up or bring it to a pick-up location.

6.1.2 TRANSPORTING THE BATTERY

1. Make sure that the **ON/OFF button** of the battery is in the **OFF** position.
2. Remove the **battery**  from the bike. See *section 4.1.3 Removing the battery*.
3. Pack the battery in a case designed to keep it safe in transit.
4. If you are shipping the battery by plane, boat, truck or train: Check with your carrier for the latest regulations.

6.2 STORING THE BIKE

There are a few main things to consider when storing the bike for a longer period of time:

- Wash the bike thoroughly. Clean grease and oil key components like the chain and the cassette. See *section 5.1 Cleaning the bike* for more details.
- Make sure that the battery is only charged to approximately 60% for storage. Check your battery regularly. If the charge drops, recharge the battery to about 60%. Do not let the battery discharge completely.

- Make sure that the **ON/OFF button** of the battery is in the **OFF** position.
- Store the bike in a dry area. Storing the bike indoors is ideal, but if you are storing your bike in an outside shed or a garage that will go below freezing temperatures, remove the battery from the bike and bring it inside. Also keep in mind that temperature changes can cause condensation, with rusted bike components and corroded battery connectors as a result.

7 PROBLEM SOLVING

ISSUE	CAUSE	SOLUTION
The headlight / rear light is not working.	The battery is empty.	<ul style="list-style-type: none"> - Check the battery status.
	The cables are not installed/connected correctly or the cables are worn.	<ul style="list-style-type: none"> - Check the wiring. - Check the electrical contacts. Contact your retailer or a skilled technician.
	One or more LEDs are broken	<ul style="list-style-type: none"> - One or more LEDs must be replaced. These can be ordered at your local Knaap retailer or at knaapbikes.com.
The brakes are not functioning properly (squealing, too tight, no resistance...).	The brake pads are not adjusted correctly.	<ul style="list-style-type: none"> - Check the brake cable. - Contact your retailer or a skilled technician.
	The brake pads may be worn.	<ul style="list-style-type: none"> - Replace the brake pads. - Contact a skilled technician, if needed.
	The wheel is not well-centered or wobbles.	<ul style="list-style-type: none"> - Your wheel must be centered. Contact your retailer or a skilled technician.



ISSUE	CAUSE	SOLUTION
The hub motor is not starting.	The battery is empty.	<ul style="list-style-type: none"> - Charge the battery. See section 4.1.2 <i>Charging the battery.</i>
	The battery terminals are not lubricated sufficiently.	<ul style="list-style-type: none"> - Lubricate the battery terminals. - Contact a skilled technician, if needed.
The bike is vibrating while in use.	The wheels are not in line with each other.	<ul style="list-style-type: none"> - Adjust the wheels. - One of the wheels or both may need to be trued. - Contact your retailer or a skilled technician.
The bike is not reaching its maximum speed.	The battery is nearly empty.	<ul style="list-style-type: none"> - Fully charge the battery. - If this does not work, maybe the battery needs replacement.

ISSUE	CAUSE	SOLUTION
The bike range is not sufficient.	The tires are not fully inflated.	- Inflate the tires.
	The charging process was interrupted or the charger is not working correctly.	- The battery or the charger must be replaced. Contact your retailer or a skilled technician.
	The battery is damaged or reached the end of its service life.	- Replace the battery.
	Frequent braking, starting off, overloading.	- Replace the battery.
The charger is not charging.	The wiring of the charger wiring is loose or damaged.	- Weld or replace the wiring. Contact your retailer or a skilled technician.
	The battery weld line falls off or is damaged.	- Weld or replace the wiring. Contact your retailer or a skilled technician.

ISSUE	CAUSE	SOLUTION
The battery is not charging.	Check the power supplies.	<ul style="list-style-type: none"> - Check whether the AC power outlet is functioning. - Check whether the charger is working. When connected to the AC power outlet, the LED should light up green. - Check whether the battery has been connected correctly. Follow the correct sequence for connecting the battery: first connect the charger to the AC power outlet and then connect the battery to the charger. NEVER connect the battery to the AC power outlet directly. - Check whether the battery terminals are free from debris.
The battery is discharging very quickly.	The charging capacity of the battery is not sufficient any more.	<ul style="list-style-type: none"> - Replace the battery.
The gears are not changing smoothly enough.	The gear cable may be slack or overtightened.	<ul style="list-style-type: none"> - Check the gear cable. - The gear shifter may be broken: If so, replace the gear shifter. - Contact your retailer or a skilled technician.

ISSUE	CAUSE	SOLUTION
<p>It takes time to shift from one gear to the other or the derailleur makes all sorts of noises.</p>	<p>The derailleur needs adjustment.</p>	<ul style="list-style-type: none"> - Check whether the hanger of the derailleur is bent. - If the hanger is not bent: Adjust the H +, L bolt. - If the hanger is bent, you must replace the hanger first. - Contact your retailer or a skilled technician.
<p>The hub motor does not start running, even with the ON/OFF switch of the battery and the ON/OFF switch of the LCD display in the ON position.</p>	<p>The speed controller is not working.</p>	<ul style="list-style-type: none"> - Check the electrical contacts. Weld them if needed. - You may need to replace the speed controller. Contact your retailer or a skilled technician.
<p>The hub motor is making a squeaking sound.</p>		<ul style="list-style-type: none"> - Contact your retailer or a skilled technician.
<p>The hub motor is holding back.</p>		<ul style="list-style-type: none"> - Contact a skilled technician.

ISSUE	CAUSE	SOLUTION
The LCD display is not showing the driving speed.	The speed sensor may not be installed correctly.	<ul style="list-style-type: none"> - Check whether the speed sensor is correctly installed. - Check the attachment of the speed sensor. It must not be attached too tightly. - Do NOT attempt to reset parameters if the display is not working. - Contact your retailer or a skilled technician.
The LCD display is not working.	The ON/OFF switch of the battery is OFF.	<ul style="list-style-type: none"> - Check whether the ON/OFF switch of the battery is in the ON position.
	The battery is not sufficiently charged.	<ul style="list-style-type: none"> - Check whether the battery is charged sufficiently.
	The relevant cables are not installed correctly or they are disconnected.	<ul style="list-style-type: none"> - Check whether the cables are connected correctly. No cables should be exposed.
	The speed sensor may not be installed correctly.	<ul style="list-style-type: none"> - Check the attachment of the speed sensor. It must not be attached too tightly.
	<ul style="list-style-type: none"> - Do NOT attempt to reset parameters if the display is not working. 	

ISSUE	CAUSE	SOLUTION
The LCD display shows an error code.	A software error occurred.	<ul style="list-style-type: none"> - Check the error code list. - Reset the LCD display: Press the  button, then unplug the display, leave the display unplugged for two minutes, plug it back in and press the  button to switch the display on again. - Contact your retailer or a skilled technician if this does not solve the error.
The pedal assist function is not working.	One or more contacts of the induced cartridge are damaged.	<ul style="list-style-type: none"> - Adjust the induced cartridge or replace it. Contact your retailer or a skilled technician.
	The pedal assist wiring is damaged.	<ul style="list-style-type: none"> - Reconnect the wiring of the pedal assist system or replace it. - Contact your retailer or a skilled technician.
	The speed sensor is not installed correctly.	<ul style="list-style-type: none"> - The speed sensor must be installed correctly - Contact your retailer or a skilled technician.

8 ENVIRONMENT AND DISPOSAL

We care for the environment. By disposing the product, its packaging and its components in the proper manner, you help to avoid possible hazards for the environment and public health that could otherwise be caused by improper treatment of waste equipment. The recycling of materials contributes to the conservation of our natural resources.

8.1 DISPOSAL OF ELECTRONIC COMPONENTS



Old or worn parts have to be disposed of in the most environmentally friendly way, for example by bringing them to an acknowledged recycling centre. It is not allowed to dispose of electronic parts, accessories and components with unsorted municipal waste. These have to be recycled separately in an environmentally friendly way in accordance with the applicable legislation.



The lithium-ion battery of your Knaap bike, as all lithium-ion batteries, contains highly toxic chemicals that cannot be disposed of with your regular household waste. eBike battery recycling programs are being launched all over the world. Dutch consumers can dispose of their used and no longer proper functioning eBike batteries by bringing them back to their local bikeshop.

8.2 DISPOSAL OF PACKAGING MATERIAL

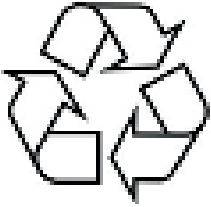

The packaging of the Knaap bike is mostly made of environmentally friendly materials. Dispose of the product packaging via a collection point for the recycling of plastics (bubble wrap) and paper (carton boxes). The foam protection sleeves are not always easy to recycle. In some areas options can be very limited, as not all recycling centres can handle or process this material. Please check with your local recycling center.

9 DISCLAIMER

Knaap bikes makes no representations or warranties with respect to this manual and, to the maximum extent permitted by law, expressly limits its liability for breach of any warranty that may be implied to the replacement of this manual with another. Furthermore, Knaap bikes reserves the right to revise this publication at any time without incurring an obligation to notify any person of the revision.

This manual contains general descriptions and/or technical characteristics of the performance of the product contained herein. This manual is not intended as a substitute for and is not to be used for determining the suitability or reliability of this product for specific user applications. Knaap bikes shall not be responsible or liable for misuse of the information that is contained herein. If you have any suggestions for improvements or amendments or have found errors in this publication, please notify us.

Copyright © 2022 by Knaap bikes

All rights reserved. No part of this publication may be reproduced, distributed, or transmitted in any form or by any means, including photocopying, recording, or other electronic or mechanical methods, without the prior written permission of the publisher.

10 TECHNICAL DATA

ITEM	SPECIFICATION
Model/type	Knaap AMS
Weight	37 kg
Load capacity	180 kg
Battery	Samsung Li-ion 21Ah 36V 756Wh or Samsung Li-ion 21Ah 48V 1.008Wh
Charger	Charger Sans Electronic Input voltage: 110 - 240 VAC / 50-60 Hz Output voltage: 42 VDC
Rear hub motor	Bafang
LCD display	Bafang C961

11 MAINTENANCE FORMS

In order to keep your bike in a good shape it must be inspected and maintained at regular intervals. Fill in all details and make sure all maintenance checks are carried out, either by yourself or a skilled technician.

MODEL INFORMATION	
Model	
Frame number	
Serial number of the drive unit	
Serial number of the battery	
Serial number of the LCD display	
Serial number of the charger	
Name of the bike shop	
Date of purchase	

OWNER CONTACT DETAILS	
Name	
Address	
Postal code + city	
E-mail	
Phone	

MAINTENANCE 500 KM / 310 MILES (OR AFTER 3 MONTHS)

Maintenance task

Repairs

Comments

Date and distance (km/mileage)

Knaap bikeshop

Signed by

MAINTENANCE 1,500 KM / 930 MILES (OR AFTER 6 MONTHS)

 Maintenance task

--

 Repairs

--

Comments	Date and distance (km/mileage)	
	Knaap bikeshop	
	Signed by	

MAINTENANCE 4,500 KM / 2,800 MILES (OR 12 MONTHS)

Maintenance task

Repairs

Comments

Date and distance (km/mileage)

Knaap bikeshop

Signed by

MAINTENANCE 7,000 KM / 4,350 MILES (OR AFTER 24 MONTHS)

 Maintenance task

--

 Repairs

--

Comments	Date and distance (km/mileage)	
	Knaap bikeshop	
	Signed by	

MAINTENANCE 9,500 KM / 5,900 MILES (OR AFTER 36 MONTHS)

Maintenance task

Repairs

Comments

Date and distance (km/mileage)

Knaap bikeshop

Signed by

MAINTENANCE 14,500 KM (OR AFTER 42 MONTHS)

Maintenance task

Repairs

Comments

Date and distance (km/mileage)

Knaap bikeshop

Signed by

MAINTENANCE 17,000 KM (OR AFTER 48 MONTHS)

Maintenance task

Repairs

Comments

Date and distance (km/mileage)

Knaap bikeshop

Signed by

MAINTENANCE _____ KM / MI		
Maintenance task		
Repairs		
Comments	Date and distance (km/mileage)	
	Knaap bikeshop	
	Signed by	

MAINTENANCE _____ KM / MI

Maintenance task

Repairs

Comments

Date and distance (km/mileage)

Knaap bikeshop

Signed by

MAINTENANCE _____ KM / MI		
Maintenance task		
Repairs		
Comments	Date and distance (km/mileage)	
	Knaap bikeshop	
	Signed by	

MAINTENANCE _____ KM / MI

Maintenance task

Repairs

Comments

Date and distance (km/mileage)

Knaap bikeshop

Signed by

“Welcome to you, the newest member of the #KnaapSquad the exclusive club for Knaap Bike

Connect with us on social media #KnaapBikes and #KnaapSquad leave a picture, comment or review describing your awesome #knaapbikes experience.

Whether you're a professional sports star, social media superstar, fashionista or the coolest kid of whatever age on your block, we know your street credibility will go through the roof on your #KnaapBikes. This really is the most Instagramable bike ever.

So what are you waiting for? You have managed to get to the end of the instruction manual so now you should know everything about your bike.

Put on your coolest clothes, make sure you buckle up your helmet, call your best friend and head out on the road!

Live the life you love! “



WWW.KNAAPBIKES.COM



knaap bikes



knaapbikes

