

**MONTAGE / MOUNTING**

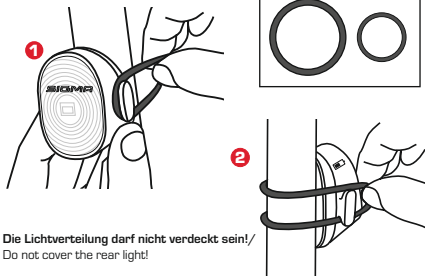

Die Lichtverteilung darf nicht verdeckt sein!  
Do not cover the rear light!

**AUSRICHTUNG / ALIGNMENT**

Abschlussseite der Schlussleuchte senkrecht zur Fahrbahn und rechtwinklig zur Fahrzeugmittellachse / Final side of the tail lamp perpendicular to the roadway and at right angles to the vehicle center axis

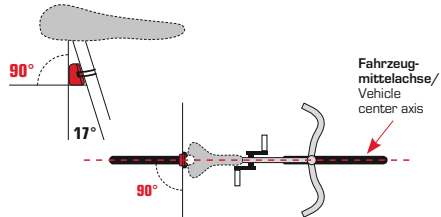

**MODUS / MODE**

**ON/OFF**

- 1 x click = on / standard
- + 1 x click = High power
- ◎ + 1 x click = High power flashing

---

- + 1 x click = off

**BATTERIESTATUS / BATTERY CONTROL**



Wenn die LED leuchtet, dann umgehend aufladen!  
If light appears, please charge!



unten / bottom

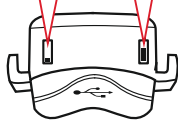

oben / top

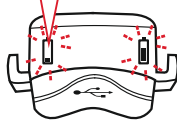

oben / top

**LADEVORGANG / CHARGING**

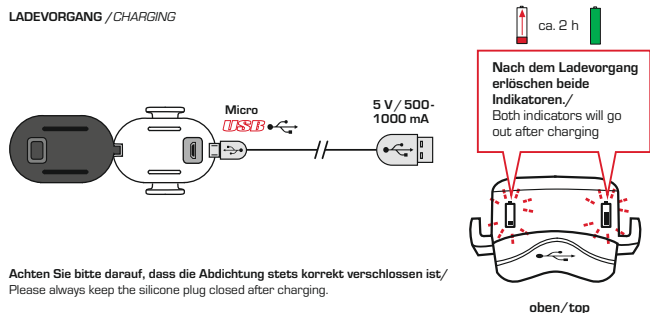

Achten Sie bitte darauf, dass die Abdichtung stets korrekt verschlossen ist!  
Please always keep the silicone plug closed after charging.

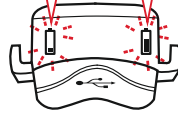

oben / top

Art.-Nr. 18552

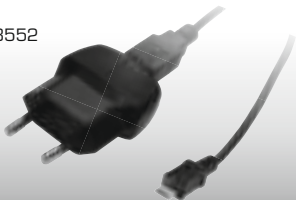

**LADEGERÄT + MICRO USB KABEL**  
**CHARGER + CHARGING CABLE MICRO-USB**

Art.-Nr. 18553



**MICRO USB KABEL**  
**CHARGING CABLE MICRO-USB**



**USB**  
**CHARGING**

**USB CABLE**  
**INSIDE**

**NUGGET II FLASH**

**SIGMA-ELEKTRO GmbH**

Dr. -Julius-Leber-Straße 15  
D-67433 Neustadt / Weinstraße

**SIGMA SPORT USA**

1860B Dean St.  
St. Charles, IL 60174, U.S.A.

**SIGMA SPORT ASIA**

4 F, No.192, Zhonggong 2<sup>nd</sup> Rd.,  
Xitun Dist., Taichung City 407, Taiwan

