

**BC 12.0 WR
BC 12.0 WL**
INSTRUCTION MANUAL

 VIDEOS &
FURTHER
INFORMATION

www.sigmasport.com
BC 12.0 wired
1 + 2 + 3

BC 12.0

1 Cable mount
Art.-Nr. 00531

2 Magnet
Art.-Nr. 00537

3 Cable ties

BC 12.0 wireless
3 + 4 + 5 + 6

BC 12.0 WL

4 Speed transmitter
Art.-Nr. 00541

5 Mount
Art.-Nr. 00535

6 Power Magnet
Art.-Nr. 00538

BC 12.0 WL CAD
3 + 4 + 5 + 6 + 7 + 8

BC 12.0 WL

7 Cadence transmitter
Art.-Nr. 00542

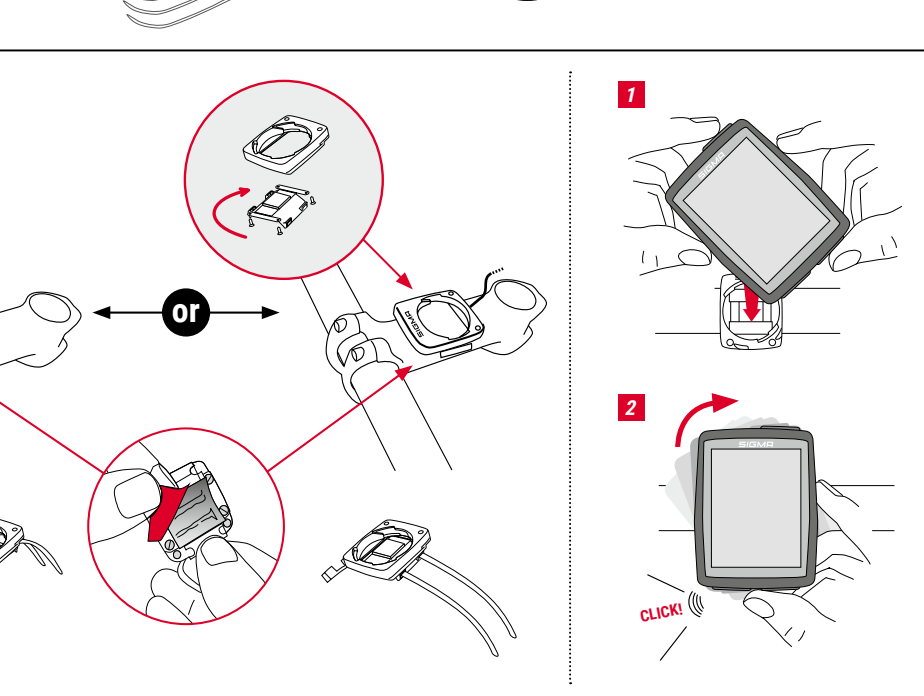
8 Cadence magnet
Art.-Nr. 00539

FIRST START

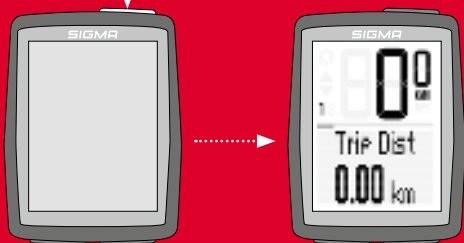
Press 5 sec.

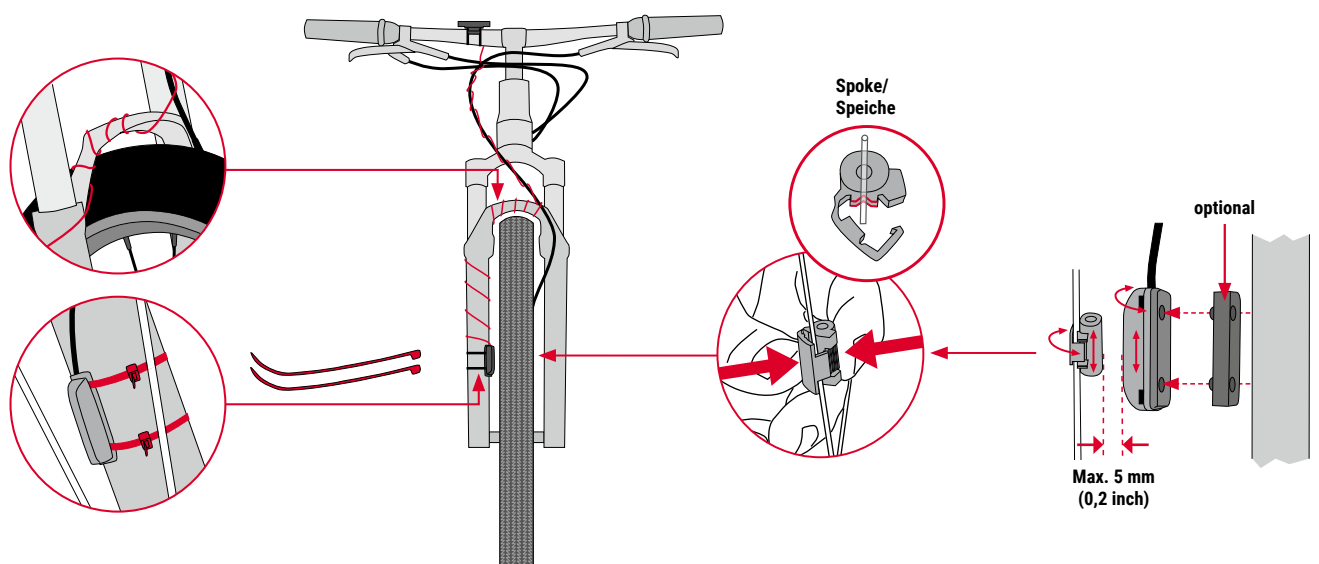

Battery already installed / Batterie bereits eingebaut /
Pile déjà installée / Batteria già installata /
Baterija ya instalada / Baterija juž instalovana /
Batterij reeds geïnstalleerd / Baterija juž zainstalovana /
Baterie je již nainstalována

INSTALLATION MOUNT
INSTALLATION WIRED SPEED SENSOR

WIRED
INSTALLATION WIRELESS SPEED TRANSMITTER

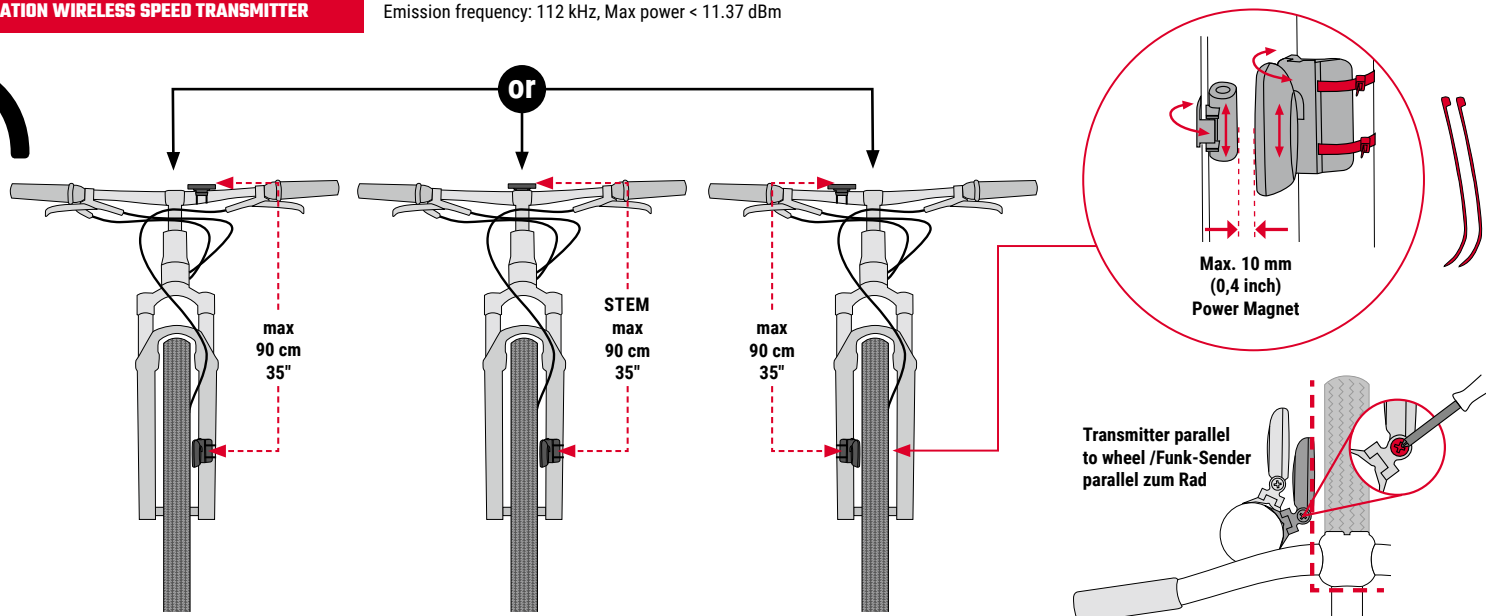
Emission frequency: 112 kHz, Max power < 11.37 dBm

WIRELESS
INSTALLATION WIRELESS CADENCE TRANSMITTER

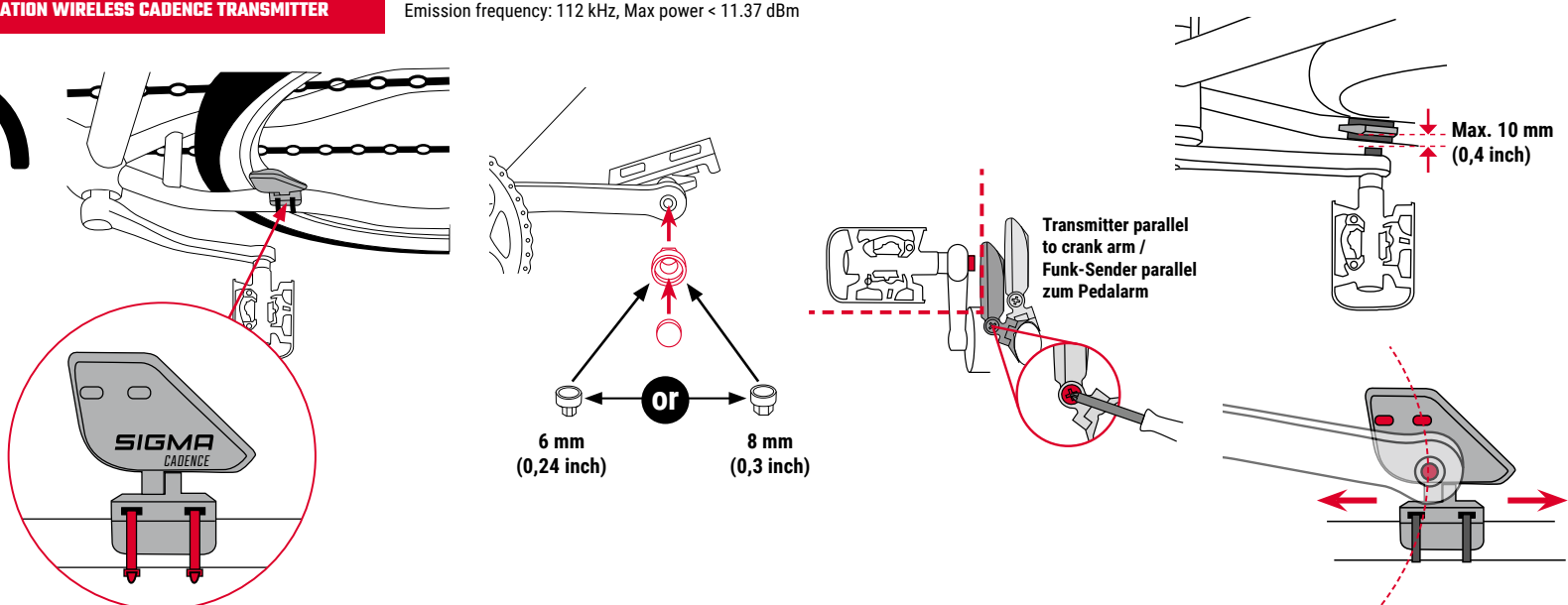
Emission frequency: 112 kHz, Max power < 11.37 dBm

WIRELESS
EN Computer WIRED:

- Battery type: CR 2450, 3V
- Battery life: 3 to 4 years
(When used for 1 hour per day)

Computer WIRELESS:

- Battery type: CR 2450, 3V
- Battery life: 2 years
(When used for 1 hour per day)
- Transmitter:**
- Battery type: CR 2032, 3V
- Battery life: 1.5 years
(When used for 1 hour per day)

DE Computer KABELGEBUNDEN:

- Batterietyp: CR 2450, 3V
- Batterielebensdauer: 3 bis 4 Jahre
(Bei einer Benutzung von 1 Stunde pro Tag)

Computer KABELLOS:

- Batterietyp: CR 2450, 3V
- Batterielebensdauer: 2 Jahre
(Bei einer Benutzung von 1 Stunde pro Tag)
- Sender:**
- Batterietyp: CR 2032, 3V
- Batterielebensdauer: 1,5 Jahre
(Bei einer Benutzung von 1 Stunde pro Tag)

FR Compteur AVEC FIL :

- Type de pile : CR 2450, 3V
- Autonomie : 3 à 4 ans
(1 heure d'utilisation par jour)

Compteur SANS FIL :

- Type de pile : CR 2450, 3V
- Autonomie : 2 ans
(1 heure d'utilisation par jour)
- Emetteur :**
- Type de pile : CR 2032, 3V
- Autonomie : 1,5 an
(1 heure d'utilisation par jour)

IT Computer DOTATO DI CAVI:

- Tipo di batteria: CR 2450, 3V
- Durata della batteria: 2 anni
(a fronte di un utilizzo di 1 ora al giorno)

Computer SENZA CAVI:

- Tipo di batteria: CR 2450, 3V
- Durata della batteria: 2 anni
(a fronte di un utilizzo di 1 ora al giorno)
- Sensore:**
- Tipo di batteria: CR 2032, 3V
- Durata della batteria: 1 anno e mezzo
(a fronte di un utilizzo di 1 ora al giorno)

ES Ordenador CON CABLE:

- Tipo de batería: CR 2450, 3V
- Duración de la batería: 3 a 4 años
(Con un uso de 1 hora diaria)

Ordenador INALÁMBRICO:

- Tipo de batería: CR 2450, 3V
- Duración de la batería: 2 años
(Con un uso de 1 hora diaria)
- Transmisor:**
- Tipo de batería: CR 2032, 3V
- Duración de la batería: 1,5 año
(Con un uso de 1 hora diaria)

PT Computador COM FIOS:

- Tipo de pilha: CR 2450, 3V
- Vida útil da pilha: entre 3 e 4 anos
(numa utilização de 1 hora por dia)

Computador SEM FIOS:

- Tipo de pilha: CR 2450, 3V
- Vida útil da pilha: 1,5 anos
(numa utilização de 1 hora por dia)
- Transmissor:**
- Tipo de pilha: CR 2032, 3V
- Vida útil da pilha: 1,5 anos
(numa utilização de 1 hora por dia)

NL Computer MET KABEL:

- Batterijtype: CR 2450, 3V
- Batterijduur: 3-4 jaar
(Bij gebruik van 1 uur per dag)

Computer ZONDER KABEL:

- Batterijtype: CR 2450, 3V
- Batterijduur: 2 jaar
(Bij gebruik van 1 uur per dag)
- Zender:**
- Batterijtype: CR 2032, 3V
- Batterijduur: 1,5 jaar
(Bij gebruik van 1 uur per dag)

PL Komputer PRZEWODOWY:

- Typ baterii: CR 2450, 3 V
- Żywotność baterii: 3 do 4 lat
(przy użytkowaniu przez 1 godzinę dziennie)

Komputer BEZPRZEWODOWY:

- Typ baterii: CR 2450, 3 V
- Żywotność baterii: 2 lat
(przy użytkowaniu przez 1 godzinę dziennie)
- Nadajnik:**
- Typ baterii: CR 2032, 3 V
- Żywotność baterii: 1,5 roku
(przy użytkowaniu przez 1 godzinę dziennie)

CZ Computer S KABELOVÝM PŘIPOJENÍM:

- Typ baterie: CR 2450, 3V
- Životnost baterie: 3 až 4 roky
(při používání 1 hodinu denně)

BEZDRÁTOVÝ computer:

- Typ baterie: CR 2450, 3V
- Životnost baterie: 2 roky
(při používání 1 hodinu denně)
- Vysílač:**
- Typ baterie: CR 2032, 3V
- Životnost baterie: 1,5 roku
(při používání 1 hodinu denně)

EU-DECLARATION OF CONFORMITY

We, SIGMA-ELEKTRO GmbH, Dr.-Julius-Leber-Str. 15, D-67433 Neustadt/Weinstraße declare under our responsibility that the product BC 12.0 WR are compliant with the essential requirements of the EMC Directive 2014/30/EU and the RoHS Directive 2011/65/EU. The declaration of conformity can be found at: ce.sigmasport.com/bc120wr

EU-KONFORMITÄTSERKLÄRUNG

Wir, SIGMA-ELEKTRO GmbH, Dr.-Julius-Leber-Str. 15, D-67433 Neustadt/Weinstraße, erklären, dass der Fahrrad-computer BC 12.0 WR bei bestimmungsgemäßer Verwendung den grundlegenden Anforderungen gemäß der EMC Directive 2014/30/EU und der RoHS Directive 2011/65/EU entspricht. Sie finden die Konformitäts-Erklärung unter folgendem Link: ce.sigmasport.com/bc120wr

We, SIGMA-ELEKTRO GmbH, Dr.-Julius-Leber-Str. 15, D-67433 Neustadt/Weinstraße declare under our responsibility that the product BC 12.0 WL and the transmitters STS-S-3 and STS-C-3 are compliant with the essential requirements and other relevant requirements of the RED Directive 2014/53/EU and the RoHS Directive 2011/65/EU. The declaration of conformity can be found at: ce.sigmasport.com/bc120wl

Wir, SIGMA-ELEKTRO GmbH, Dr. Julius Leber Str. 15, D-67433 Neustadt/Weinstraße erklären, dass der Fahrrad-computer mit Funkübertragung BC 12.0 WL und die Sender STS-S-3 und STS-C-3 bei bestimmungsgemäßer Verwendung den grundlegenden Anforderungen gemäß RED Directive 2014/53/EU und der RoHS Directive 2011/65/EU entsprechen. Sie finden die Konformitäts-Erklärung unter folgendem Link: ce.sigmasport.com/bc120wl

CE INFORMATION

EN You can find the CE declaration at:
ce.sigmasport.com/bc120wr
ce.sigmasport.com/bc120wl

PT Poderá encontrar a declaração CE em:
ce.sigmasport.com/bc120wr
ce.sigmasport.com/bc120wl

DE Sie finden die Konformitäts-Erklärung unter folgendem Link:
ce.sigmasport.com/bc120wr
ce.sigmasport.com/bc120wl

NL U kunt de CE-certificering vinden op:
ce.sigmasport.com/bc120wr
ce.sigmasport.com/bc120wl

FR Vous trouverez la déclaration CE à l'adresse :
ce.sigmasport.com/bc120wr
ce.sigmasport.com/bc120wl

PL Deklaracja CE znajduje się na stronie:
ce.sigmasport.com/bc120wr
ce.sigmasport.com/bc120wl

IT La dichiarazione CE è disponibile all'indirizzo:
ce.sigmasport.com/bc120wr
ce.sigmasport.com/bc120wl

CZ ES prohlášení najdete na adrese:
ce.sigmasport.com/bc120wr
ce.sigmasport.com/bc120wl

ES Puede encontrar la declaración de conformidad CE en:
ce.sigmasport.com/bc120wr
ce.sigmasport.com/bc120wl

FEDERAL COMMUNICATION COMMISSION INTERFERENCE STATEMENT

Caution: If any changes or modifications not expressly approved by the party responsible for compliance could void the user's authority to operate the equipment.

This device complies with Part 15 of the FCC Rules. Operation is subject to the following two conditions: (1) This device may not cause harmful interference, and (2) This device must accept any interference received, including interference that may cause undesired operation.

The grantee is not responsible for any changes or modifications not expressly approved by the party responsible for compliance. Such modifications could void the user's authority to operate the equipment.

The RF Exposure Compliance distance is 5 millimeters.

NOTE: This equipment has been tested and found to comply with the limits for a Class B digital device, pursuant to part 15 of the FCC Rules. These limits are designed to provide reasonable protection against harmful interference in a residential installation. This equipment generates, uses and can radiate radio frequency energy and, if not installed and used in accordance with the instructions, may cause harmful interference to radio communications. However, there is no guarantee that interference will not occur in a particular installation. If this equipment does cause harmful interference to radio or television reception, which can be determined by turning the equipment off and on, the user is encouraged to try to correct the interference by one or more of the following measures:

- Reorient or relocate the receiving antenna.
- Increase the separation between the equipment and receiver.
- Connect the equipment into an outlet on a circuit different from that to which the receiver is connected.
- Consult the dealer or an experienced radio/TV technician for help.

FCC ID STS-S-3: M5LSP03STS

FCC ID STS-C-3: M5LCAD3STS

INDUSTRY CANADA STATEMENT

This device complies with Innovation, Science and Economic Development Canada licence-exempt RSS standard(s). Operation is subject to the following two conditions: (1) this device may not cause interference, and (2) this device must accept any interference, including interference that may cause undesired operation of the device. CAN ICES-3(B)/NMB-3(B)

Le présent appareil est conforme aux CNR Innovation, Sciences et Développement économique Canada applicables aux appareils radio exempts de licence. L'exploitation est autorisée aux deux conditions suivantes: (1) il ne doit pas produire de brouillage et (2) l'utilisateur du dispositif doit être prêt à accepter tout brouillage radioélectrique reçu, même si ce brouillage est susceptible de compromettre le fonctionnement du dispositif. CAN ICES-3(B)/NMB-3(B)

The device meets the exemption from the routine evaluation limits in section 2.5 of RSS 102 and compliance with RSS-102 RF exposure, users can obtain Canadian information on RF exposure and compliance.

Le dispositif rencontre l'exemption des limites courantes d'évaluation dans la section 2.5 de RSS 102 et la conformité à l'exposition de RSS-102 rf, utilisateurs peut obtenir l'information canadienne sur l'exposition et la conformité de rf.

This transmitter must not be co-located or operating in conjunction with any other antenna or transmitter. This equipment should be installed and operated with a minimum distance of 5 millimeters between the radiator and your body.

Cet émetteur ne doit pas être Co-placé ou ne fonctionnant en même temps qu'aucune autre antenne ou émetteur. Cet équipement devrait être installé et actionné avec une distance minimum de 5 millimètres entre le radiateur et votre corps.

UKCA STATEMENT

Wireless Model
We, SIGMA-ELEKTRO GmbH, declare that the equipment above has been tested in our facility and found compliance with the requirement limits of applicable standards, in accordance with the Radio Equipment Regulations 2017 and the Restriction of the Use of Certain Hazardous Substances in Electrical and Electronic Equipment Regulations 2012. The test record, data evaluation and Equipment Under Test (EUT) configurations represented herein are true and accurate under the standards herein specified.

Wired Model
We, SIGMA-ELEKTRO GmbH, declare that the equipment above has been tested in our facility and found compliance with the requirement limits of applicable standards, in accordance with the Electromagnetic Compatibility Regulations 2016 and the Restriction of the Use of Certain Hazardous Substances in Electrical and Electronic Equipment Regulations 2012. The test record, data evaluation and Equipment Under Test (EUT) configurations represented herein are true and accurate under the standards herein specified.

SIGMA-ELEKTRO GmbH
Dr.-Julius-Leber-Straße 15
67433 Neustadt/Weinstraße, Germany
kundenservice@sigmasport.com



FUNCTIONS / SETTINGS

BUTTON OVERVIEW

- DE**
- A: MENÜ-Taste:**
- Kurz drücken = SET/OK
- Lange drücken = Menü
- B: LEFT-Taste:**
- Kurz drücken = Zurück blättern / Wert verringern
- C: RIGHT-Taste:**
- Kurz drücken = Vorwärts blättern / Wert erhöhen
- Lange drücken = Tourdaten zurücksetzen

- FR**
- A: Bouton MENU:**
- Pression longue = Menu
- Pression brève = SET/OK
- B: Bouton GAUCHE:**
- Pression brève = Page précédente/Diminuer la valeur
- C: Bouton DROIT:**
- Pression brève = Page suivante/Augmenter la valeur
- Pression longue = Réinitialiser données de la tour

- IT**
- A: Pulsante MENU:**
- Pressione prolungata = Menu
- Pressione breve = SET/OK
- B: Pulsante SINISTRO:**
- Pressione breve = Scorrere a sinistra/diminuire il valore
- C: Pulsante DESTRO:**
- Pressione breve = Scorrere a destra/aumentare il valore
- Pressione prolungata = Reset dati dell'escursione

- ES**
- A: Botón de MENÚ:**
- Pulsación prolongada = Menú
- Pulsación breve = SET/OK
- B: Botón IZQUIERDO:**
- Pulsación breve = Mover a la izquierda / reducir valor
- C: Botón DERECHO:**
- Pulsación breve = Mover a derecha / Aumentar valor
- Pulsación prolongada = Resetear datos de recorrido

- PT**
- A: Botão MENU:**
- Pressão longa = Menu
- Pressão curta = DEFINIR/OK
- B: Botão ESQUERDO:**
- Pressão curta = Computar para a esquerda/Diminuir valor
- C: Botão DIREITO:**
- Pressão curta = Computar para a direita/Aumentar valor
- Pressão longa = Repor dados de percurso

- NL**
- A: MENU-knop:**
- Lang indrukken = Menu
- Kort indrukken = SET/OK
- B: LINKER knop:**
- Kort indrukken = Wisselen van scherm naar links/Waarde verlagen
- C: RECHTER knop:**
- Kort indrukken = Wisselen van scherm naar rechts / Waarde verhogen
- Lang indrukken = Ritdata reset

- PL**
- A: Przycisk MENU:**
- długie naciśnięcie = Menu
- krótkie naciśnięcie = SET/OK
- B: Lewy PRZYCIŚK:**
- krótkie naciśnięcie = przełącz w lewo/zmniejsz wartość
- C: Prawy PRZYCIŚK:**
- krótkie naciśnięcie = przełącz w prawo/zwiększ wartość
- długie naciśnięcie = resetowa nie danych trasy

- CZ**
- A: Tlačítko MENU:**
- Dlouhé stisknutí = Menu
- Krátké stisknutí = NASTAVIT/OK
- B: LEVÉ tlačítko:**
- Krátké stisknutí = Přepnutí vlevo/Snížení hodnoty
- C: PRAVÉ tlačítko:**
- Krátké stisknutí = Přepnutí vpravo/Zvýšení hodnoty
- Dlouhé stisknutí = Reset dat jízdy

BATTERY CHANGE

BC 12.0 WR/WL

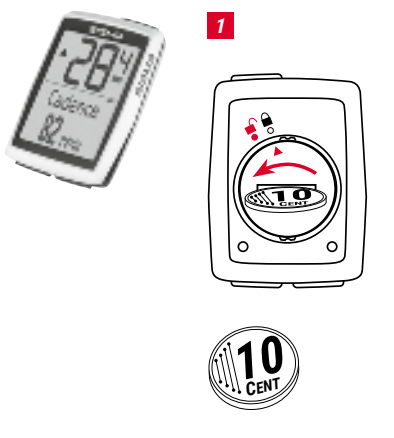

MENU BASIC BIKE FUNCTIONS

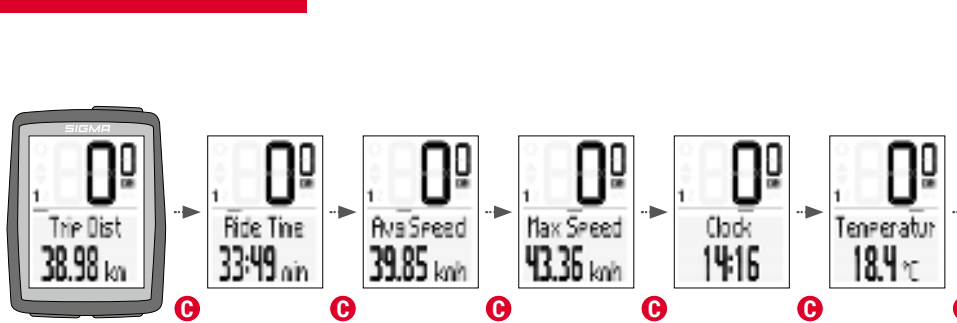

DISPLAY OVERVIEW

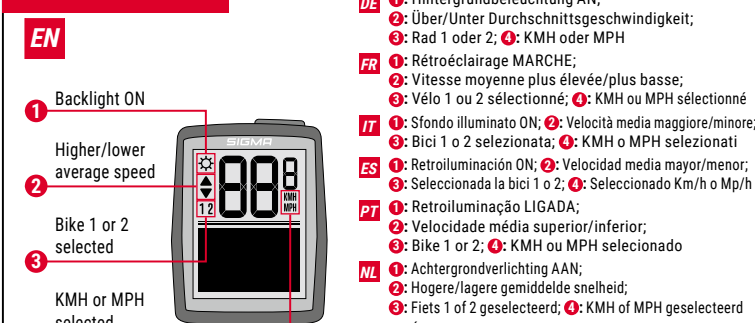

SETTINGS MENU

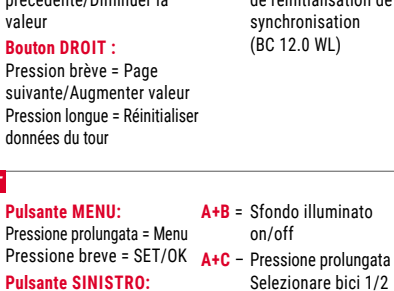

- A: Pulsante MENU:**
- Pressione prolungata = Menu
- Pressione breve = SET/OK
- B: Pulsante SINISTRO:**
- Pressione breve = Scorrere a sinistra/diminuire il valore
- C: Pulsante DESTRO:**
- Pressione breve = Scorrere a destra/aumentare il valore
- Pressione prolungata = Reset dati dell'escursione

- ES**
- A: Botón de MENÚ:**
- Pulsación prolongada = Menú
- Pulsación breve = SET/OK
- B: Botón IZQUIERDO:**
- Pulsación breve = Mover a la izquierda / reducir valor
- C: Botón DERECHO:**
- Pulsación breve = Mover a derecha / Aumentar valor
- Pulsación prolongada = Resetear datos de recorrido

- PT**
- A: Botão MENU:**
- Pressão longa = Menu
- Pressão curta = DEFINIR/OK
- B: Botão ESQUERDO:**
- Pressão curta = Computar para a esquerda/Diminuir valor
- C: Botão DIREITO:**
- Pressão curta = Computar para a direita/Aumentar valor
- Pressão longa = Repor dados de percurso

- NL**
- A: MENU-knop:**
- Lang indrukken = Menu
- Kort indrukken = SET/OK
- B: LINKER knop:**
- Kort indrukken = Wisselen van scherm naar links/Waarde verlagen
- C: RECHTER knop:**
- Kort indrukken = Wisselen van scherm naar rechts / Waarde verhogen
- Lang indrukken = Ritdata reset

- PL**
- A: Przycisk MENU:**
- długie naciśnięcie = Menu
- krótkie naciśnięcie = SET/OK
- B: Lewy PRZYCIŚK:**
- krótkie naciśnięcie = przełącz w lewo/zmniejsz wartość
- C: Prawy PRZYCIŚK:**
- krótkie naciśnięcie = przełącz w prawo/zwiększ wartość
- długie naciśnięcie = resetowa nie danych trasy

- CZ**
- A: Tlačítko MENU:**
- Dlouhé stisknutí = Menu
- Krátké stisknutí = NASTAVIT/OK
- B: LEVÉ tlačítko:**
- Krátké stisknutí = Přepnutí vlevo/Snížení hodnoty
- C: PRAVÉ tlačítko:**
- Krátké stisknutí = Přepnutí vpravo/Zvýšení hodnoty
- Dlouhé stisknutí = Reset dat jízdy

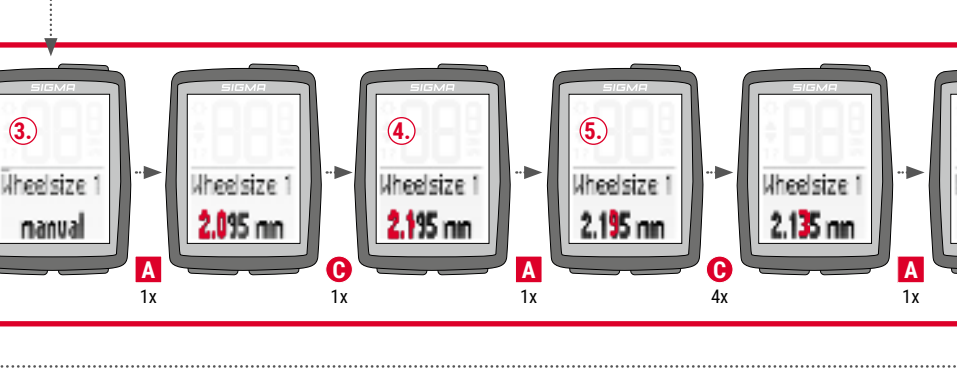
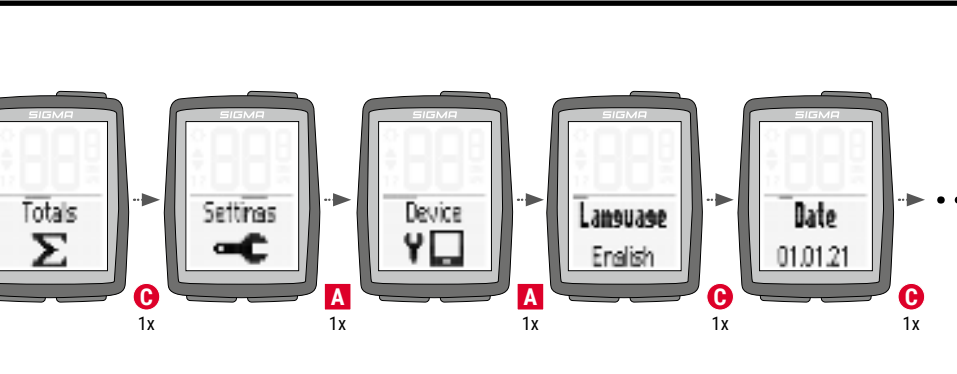
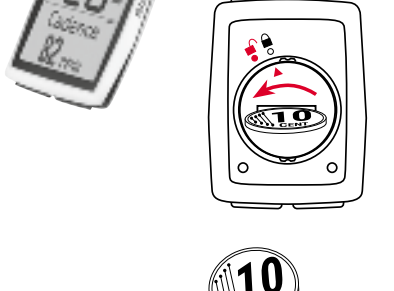

- EN EXAMPLE OF SETTING PROCEDURE:**
- Open menu: Press and hold **A** button until the menu opens
 - Toggle to **SETTINGS** page with the **B** or the **C** button
 - Open the **SETTINGS** menu by pressing the **A** button
 - Toggle in the **SETTINGS** menu to the **DEVICE** settings with the **B** or the **C** button
 - Open settings by pressing the **A** button
 - Toggle to **WHEELSIZE 1** setting by pressing the **B** or the **C** button
 - Press **A** button to start adjustment of the **WHEELSIZE 1**
 - Change value by pressing the **B** or the **C** button
 - Confirm adjusted value by pressing **A** button
- Note:** Do steps No. 8 and No. 9 until all numbers are adjusted
- a. Go back to former menu level: Toggle to back page by pressing the **B** or the **C** button
Confirm with the **A** button
 - b. Close menu: Press and hold the **A** button (3 sec.)

- IT ESEMPIO DI PROCEDURA DI IMPOSTAZIONE:**
- Aprire il menu: tenere premuto il pulsante **A** finché non si apre il menu
 - Scorrere fino alla pagina **IMPOSTAZIONI** con il pulsante **B** o **C**
 - Aprire il menu **IMPOSTAZIONI** premendo il pulsante **A**
 - Scorrere nel menu **IMPOSTAZIONI** fino alle impostazioni del **DISPOSITIVO** con il pulsante **B** o **C**
 - Aprire le impostazioni premendo il pulsante **A**
 - Scorrere fino all'impostazione **CIRCONFERENZA RUOTA 1** premendo il pulsante **B** o **C**
 - Premere il pulsante **A** per iniziare a regolare la **CIRCONFERENZA RUOTA 1**
 - Cambiare il valore premendo il pulsante **B** o **C**
 - Confermare il valore regolato premendo il pulsante **A**
- Nota:** eseguire i passaggi n. 8 e n. 9 finché non sono stati regolati tutti i valori
- a. Tornare al livello di menu precedente: scorrere fino all'ultima pagina premendo il pulsante **B** o **C**
Confermare con il pulsante **A**
 - b. Chiudere il menu: tenere premuto il pulsante **A** (3 sec.)

- NL VOORBEELD VAN INSTELPROCEDURE:**
- Open menu: houd de **A**-knop ingedrukt totdat het menu opent
 - Wissel naar de **INSTELLINGEN** pagina met de **B** of **C** knop
 - Open het **INSTELLINGEN** menu door op de **A**-knop te drukken
 - Wissel in het **INSTELLINGEN** menu met de **B** of **C** knop naar de **APPARAAT-instellingen**
 - Open instellingen door op de **A**-knop te drukken
 - Wissel naar **WIELMAAT 1** door op de **B** of **C** knop te drukken
 - Druk op de **A**-knop om de **WIELMAAT 1** aan te passen
 - Wijzig de waarde door op de **B** of **C** knop te drukken
 - Bevestig de ingestelde waarde door op de **A**-knop te drukken
- Opmerking:** voer stappen nr. 8 en nr. 9 uit totdat alle waarden zijn aangepast
- a. Ga terug naar het vorige menuniveau: wissel naar pagina terug door op de **B** of **C** knop te drukken
Bevestig met de **A**-knop
 - b. Sluit menu: houd de **A**-knop ingedrukt (3 s)

SPEED TRANSMITTER (BC 12.0 WL)

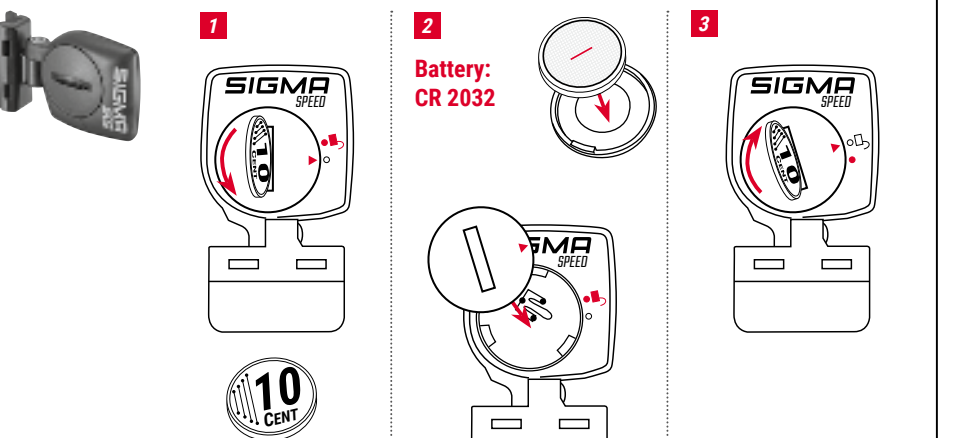

CADENCE TRANSMITTER (BC 12.0 WL)

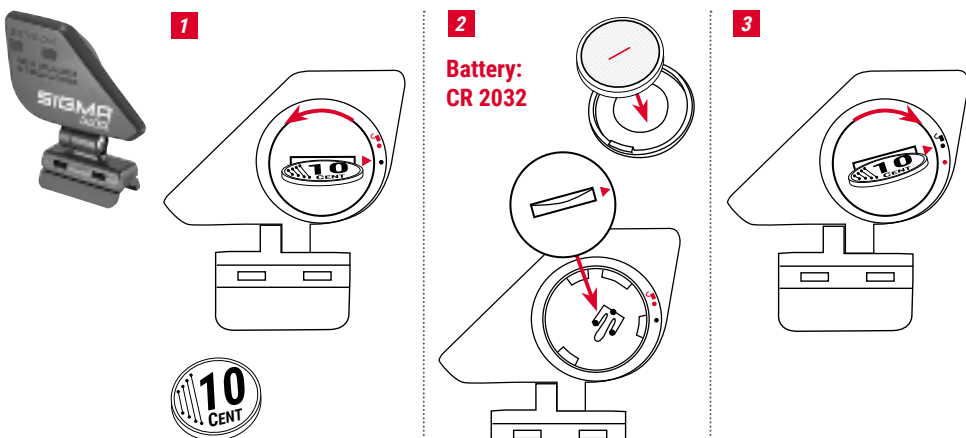

CHOOSE YOUR SPECIFIC WHEEL SIZE / WÄHLE DEINE SPECIFISCHE RAGRÖSSE

mm	inch	
16"	1253	49,3
18"	1411	55,6
20"	1590	62,6
22"	1770	69,7
24"	1907	75,1
26"	2085	82,1
27"	2195	86,4
27.5"	2180	85,8
28"	2200	86,6
29"	2300	90,5
700C	2095	82,5

1x = WS (mm)

EXAMPLE VALUE:
WS = 2135 mm

km/h: WS = mm
mph: WS = mm

Note: 1 inch = 25.4 mm

- FR EXEMPLE DE PROCÉDURE DE RÉGLAGE:**
- Ouvrir le menu : appuyer sur le bouton **A** et le maintenir enfoncé jusqu'à ce que le menu s'ouvre
 - Basculer vers la page **PARAMÈTRES** avec le bouton **B** ou **C**
 - Ouvrir le menu **PARAMÈTRES** en appuyant sur le bouton **A**
 - Dans le menu **PARAMÈTRES**, basculer vers les paramètres de l'**APPAREIL** avec le bouton **B** ou **C**
 - Ouvrir les paramètres souhaités en appuyant sur le bouton **A**
 - Basculer vers le paramètre **TAILLE DE ROUE 1** en appuyant sur le bouton **B** ou **C**
 - Appuyer sur le bouton **A** pour débiter le réglage de la **TAILLE DE ROUE 1**
 - Modifier la valeur en appuyant sur le bouton **B** ou **C**
 - Confirmer la valeur réglée en appuyant sur le bouton **A**
- Remarque:** effectuer les étapes n° 8 et n° 9 jusqu'à ce que toutes les valeurs soient réglées
- a. Revenir au niveau de menu précédent : basculer vers la page précédente en appuyant sur le bouton **B** ou **C**
Confirmer avec le bouton **A**
 - b. Fermer le menu : appuyer sur le bouton **A** et le maintenir enfoncé (3 sec.)

- PT EXEMPLO DE PROCEDIMENTO DE DEFINIÇÃO:**
- Abriu menu: manter premido o botão **A** até abrir o menu
 - Comutar para a página **DEFINIÇÕES** com o botão **B** ou **C**
 - Abriu o menu **DEFINIÇÕES** premindo o botão **A**
 - Comutar no menu **DEFINIÇÕES** para as definições do **DISPOSITIVO** com o botão **B** ou **C**
 - Abriu definições premindo o botão **A**
 - Comutar para a definição **TAMANHO DE RODA 1** premindo o botão **B** ou **C**
 - Premir o botão **A** para iniciar o ajuste do **TAMANHO DE RODA 1**
 - Alterar valor premindo o botão **B** ou **C**
 - Confirmar o valor ajustado premindo o botão **A**
- Nota:** execute os passos 8 e 9 até todos os números estarem ajustados
- a. Voltar para o nível de menu anterior: comutar para a página anterior premindo o botão **B** ou **C**
Confirmar com o botão **A**
 - b. Fechar menu: manter premido o botão **A** (3 seg)

- CZ PŘÍKLAD POSTUPU NASTAVENÍ:**
- Otevření menu: Stisknete a podržte tlačítko **A**, dokud se menu neotevře
 - Přepněte na stránku **NASTAVENÍ** pomocí tlačítka **B** nebo **C**
 - Otevřete menu **NASTAVENÍ** stisknutím tlačítka **A**
 - V menu **NASTAVENÍ** přepněte pomocí tlačítka **B** nebo **C** na nastavení **ZAŘÍZENÍ**.
 - Otevřete nastavení stisknutím tlačítka **A**
 - Přepněte na nastavení **VELIKOST KOLA 1** stisknutím tlačítka **B** nebo **C**
 - Stisknutím tlačítka **A** zahájíte nastavení **VELIKOSTI KOLA 1**
 - Změňte hodnotu stisknutím tlačítka **B** nebo **C**
 - Potvrďte nastavenou hodnotu stisknutím tlačítka **A**
- Poznámka:** Opakujte kroky 8 a 9, dokud nebudou nastavena všechna čísla
- a. Vraťte se na předchozí úroveň menu: Přepněte na předchozí stránku stisknutím tlačítka **B** nebo **C**
Potvrďte tlačítkem **A**
 - b. Zavření menu: Stisknete a podržte tlačítko **A** (3 s)