

ALPINE

7-INCH AUDIO/VIDEO RECEIVER

iLX-W690D



- OWNER'S MANUAL
Please read before using this equipment.
- BEDIENUNGSANLEITUNG
Lesen Sie diese Bedienungsanleitung bitte vor Gebrauch des Gerätes.
- MODE D'EMPLOI
Veuillez lire avant d'utiliser cet appareil.
- MANUAL DE OPERACIÓN
Léalo antes de utilizar este equipo.
- РУКОВОДСТВО ПО ЭКСПЛУАТАЦИИ
Прочтите настоящее руководство перед началом использования оборудования.

ALPINE ELECTRONICS OF AMERICA, INC.

1500 Atlantic Blvd,
Auburn Hills, Michigan 48326, U.S.A.
Phone 1-800-ALPINE-1 (1-800-257-4631)

ALPINE ELECTRONICS OF AUSTRALIA PTY. LIMITED

161-165 Princes Highway,
Hallam Victoria 3803, Australia
Phone 03-8787-1200

ALPS ALPINE EUROPE GMBH

Ohmstrasse 4, 85716 Unterschleissheim, Germany
Phone: +49 (0) 89-32 42 640
For contact information on your respective country,
please visit www.alpine-europe.com.

ALPS ALPINE EUROPE GMBH

Aurora House, Deltic Avenue
Rooksley, Milton Keynes, MK13 8LW
United Kingdom
Phone: 0345-313-1640

ALPS ALPINE ASIA CO., LTD.

The 9th Towers, Tower B, 24th Floor, Unit TNB01-03,
33/4 Rama 9 road, Huay Kwang, Bangkok, 10310, Thailand
Phone +66 (2) 090 9596

ALPS ALPINE CO., LTD.

20-1 Yoshima Industrial park,
Iwaki, Fukushima, Japan 970-1192
Phone 0246-36-4111

CONTENTS

Operating Instructions

WARNING

Points to Observe for Safe Usage	6
WARNING	6
CAUTION	7
NOTICE	7

Getting Started

Location of Controls	9
Turning Power On or Off.....	9
Adjusting the Volume	9
Lowering Volume Quickly	9
Touch Screen Operation	10
Switching Sources.....	10
Selecting an Item in a List	10
About the HOME Screen.....	11
Editing HOME screen	11
About the Indicator Display	12

Setup

Setup Operation	12
-----------------------	----

General Setup

Radio Setup	13
Setting the TUNER (FM) Tone Quality (Tuner Condition)	13
PI SEEK Setting	13
Receiving RDS Regional (Local) Stations	13
Setting PTY31 (Emergency Broadcast) Reception	13
DAB Setup.....	14
Setting Emergency Announcement Reception	14
Setting Announcement Reception.....	14
Setting the DAB-DAB Linking ON/OFF (Service Following).....	14
Setting the DAB-FM Linking ON/OFF (Service Following).....	14
Setting the DAB Antenna ON/OFF	14
AUX Setup.....	15

Setting the Input Signal.....	15
Setting the Display Mode.....	15
Language Setup	15
Wallpaper Setup	15
Setting a Wallpaper using a default image....	15
Setting a Wallpaper using your image	15
Screen/LED Customize Setup	16
Setting the Brightness of the Backlighting (Dimmer).....	16
Adjusting the Minimum Level of Backlight	16
Adjusting the Dimmer of Button Lighting at Night.....	16
Date/Clock Setup	16
Display Off Setting.....	16
About iLX-W690D.....	17
Displaying the Product Information.....	17
Displaying Warranty/Copyright Information	17
Initializing the System	17
Installation Setup	17
Steering Wheel Position Setting	17
Mute Setting	17
CAN I/F BOX Setting	18
Setting the Default Vehicle Screen	18
Setting the Parking Assist Enable.....	18
Setting the Climate Screen Interrupt Time	18

Connection (Bluetooth) Setup

Displaying Bluetooth Information	18
Pairing the Bluetooth Device.....	18
Setting the Bluetooth Device	19
Deleting a Bluetooth Device from the list.....	19
Apple CarPlay Setup.....	19

Camera Setup

Rear Camera Setup	20
Camera Input Setting	20
Camera Signal Input Setting.....	20
Rear Camera Guide Settings	20
Camera Picture Quality Setup	21
Camera Interrupt Setting (DISPLAY OFF Mode).....	21
Front Camera Setup	21
Camera Input Setting	21
Camera Signal Input Setting.....	21

Camera Picture Quality Setup	22
Sound Setup	
Setting the Media Xpander (MX)	22
Equalizer Settings	23
Fader/Balance/Bass/Treble/Subwoofer Settings	23
Setting the Fader/Balance	23
Adjusting the Bass/Treble	23
Setting the Subwoofer	23
Graphic Equalizer Curve Settings (Graphic EQ)	24
Time Correction Settings	24
Crossover Settings (X-Over)	25
Volume Setup	25
Adjusting the Key Sound	25
Adjusting the Source Volume	26
Setting the Volume for Android Auto™	26
Setting the Volume for Apple CarPlay	26
Adjusting the Volume for Phone	26
Turning Subwoofer ON/OFF	26
Rear Speaker Setting	26
Defeat Setting	26
About the Crossover	27
About Time Correction	27

Apple CarPlay (Optional)

Access to Apple CarPlay	29
-------------------------------	----

Android Auto (Optional)

What is Android Auto	29
Activate Android Auto	29

Radio/RDS

Radio Basic Operation

Listening to the Radio	30
Presetting Stations Manually	30
Presetting Stations Automatically	31
Tuning to Preset Station	31

RDS Operation

Turning AF (Alternative Frequencies) On or Off	31
Interruption Function	31
Receiving Traffic Announcement	32
Receiving Traffic Information Manually	32
Selecting the Receivable PTY	32
Displaying Radio Text	32

DAB/DAB+

Listening to DAB/DAB+	33
Presetting Service	33
Tuning to Preset Service	33
Service Component/PTY Search Function	34
Service Search Function	34
PTY Search Function	34
Interruption Function	34
Receiving Traffic Announcement	34
Displaying DAB Text	34
About DAB/DAB+	34

USB Flash drive (Optional)

USB Audio

Playback	35
Repeat Play	35
Shuffle Play	36
Searching for a Desired Song	36

USB Video

Fast-forwarding/Fast-reversing	37
Stopping Playback	37
Repeat Play	37
Searching for a Desired file	37
Setting the Brightness and Contrast	37
Displaying the Subtitle	37

USB Photo

Playback	38
Slide Show	38
Setting a Wallpaper with a Photo	38

iPod mode on iPhone (Optional)

Playback	39
Searching for a Music File	40
Repeat Play	40
Shuffle Play	40

HDMI Device (Optional)

HDMI Operation	41
Setting the Brightness and Contrast	41

Bluetooth Operation

Setup Before Using	42
About Bluetooth	42
About the Hands-free Phone	42
Before Using Bluetooth	42

Hands-free Phone Control

Answering a Call	43
Hanging up the Telephone	43
Calling	43
Making a phone call using the Phone	
Menu	43
Using Voice Recognition function	44
Using Siri	44
Voice Dial Function	44
Phone Operation Screen	45
Adjusting the Speech Volume	45
Changing the Voice Output	45
Muting the Microphone	45
DTMF (Touch-Tone) Function	45
Phone Book Function	45
Searching in the Phone Book	45
Synchronizing the Phone Book	45
Deleting the Phone Book Entries	46
Setting contacts as Favorites	
(Shortcut Dialing)	46

Bluetooth Audio

Playback	47
Repeat Play	47
Shuffle Play	47
Connecting a Bluetooth Device	47
Disconnecting the Bluetooth Connection	47
Switching the connecting Bluetooth	
Device	47

Auxiliary Device (Optional)

Operating Auxiliary Devices (Optional)	48
Setting the Brightness and Contrast	48

Camera Operation (Optional)

Rear Camera Operation	49
Displaying the Camera Image from the	
HOME screen	49
Displaying the rear view video while the	
car is in reverse	49
About the Rear Camera Guide	49
Front Camera Operation	51
Displaying the Camera Image from the	
HOME screen	51

About Vehicle Interlock Function

Access to Vehicle Info Mode	52
About Parking Sensor screen	53

Information

Product Software Update	54
About the Supported Formats	54
About MP3/WMA/AAC/FLAC/WAV	54
In Case of Difficulty	56
If this Message Appears	56
Specifications	57

Installation and Connections

WARNING	59
CAUTION	59
Precautions	59
Accessory List	60
Installation	60
Caution concerning the installation	
location	60
Mounting the Microphone	60
Installation example using the Original	
Mounting Bracket	60
Connections	61
If an ACC power supply is not available	64
System Example	65

Operating Instructions

WARNING

Points to Observe for Safe Usage

- Read this manual carefully before using this system components. They contain instructions on how to use this product in a safe and effective manner. Alpine cannot be responsible for problems resulting from failure to observe the instructions in this manual.
- This manual uses various pictorial displays to show you how to use this product safely and to alert you to potential dangers resulting from improper connections and operation. Following are the meanings of these pictorial displays. It is important to fully understand the meanings of these pictorial displays in order to use this manual and the system properly.
- This product may be used with software applications. Please follow all usage instructions and warnings when using this product at all times. Do not use this product or any software application in a manner which will hinder safe operation of your vehicle.

WARNING

- Operation of the system while driving is dangerous. Users should stop vehicle before operating the software.
- Road conditions and regulations take precedence over information contained on the map display: observe actual traffic restrictions and circumstances while driving.
- This software is designed for use exclusively in the unit. It cannot and may not be used in conjunction with other hardware.

WARNING

This symbol means important instructions. Failure to heed them can result in serious injury or death.

INSTALL THE PRODUCT CORRECTLY SO THAT THE DRIVER CANNOT WATCH TV/VIDEO UNLESS THE VEHICLE IS STOPPED AND THE EMERGENCY BRAKE IS APPLIED.

It is dangerous for the driver to watch TV/Video while driving a vehicle. Installing this product incorrectly enables the driver to watch TV/Video while driving. This may cause a distraction, preventing the driver from looking ahead, thus causing an accident. The driver or other people could be severely injured.

DO NOT WATCH VIDEO WHILE DRIVING.

Watching the video may distract the driver from looking ahead of the vehicle and cause an accident.

DO NOT OPERATE ANY FUNCTION THAT TAKES YOUR ATTENTION AWAY FROM SAFELY DRIVING YOUR VEHICLE.

Any function that requires your prolonged attention should only be performed after coming to a complete stop. Always stop the vehicle in a safe location before performing these functions. Failure to do so may result in an accident.

KEEP THE VOLUME AT A LEVEL WHERE YOU CAN STILL HEAR OUTSIDE NOISES WHILE DRIVING.

Excessive volume levels that obscure sounds such as emergency vehicle sirens or road warning signals (train crossings, etc.) can be dangerous and may result in an accident. LISTENING AT LOUD VOLUME LEVELS IN A CAR MAY ALSO CAUSE HEARING DAMAGE.

MINIMIZE DISPLAY VIEWING WHILE DRIVING.

Viewing the display may distract the driver from looking ahead of the vehicle and cause an accident.

DO NOT DISASSEMBLE OR ALTER.

Doing so may result in an accident, fire or electric shock.

USE ONLY IN CARS WITH A 12 VOLT NEGATIVE GROUND.

(Check with your dealer if you are not sure.) Failure to do so may result in fire, etc.

KEEP SMALL OBJECTS SUCH AS SCREWS OUT OF THE REACH OF CHILDREN.

Swallowing them may result in serious injury. If swallowed, consult a physician immediately.

USE THE CORRECT AMPERE RATING WHEN REPLACING FUSES.

Failure to do so may result in fire or electric shock.

DO NOT BLOCK VENTS OR RADIATOR PANELS.

Doing so may cause heat to build up inside and may result in fire.

USE THIS PRODUCT FOR MOBILE 12V APPLICATIONS.

Use for other than its designed application may result in fire, electric shock or other injury.

MAKE THE CORRECT CONNECTIONS.

Failure to make the proper connections may result in fire or product damage.

BEFORE WIRING, DISCONNECT THE CABLE FROM THE NEGATIVE BATTERY TERMINAL.

Failure to do so may result in electric shock or injury due to electrical shorts.

DO NOT ALLOW CABLES TO BECOME ENTANGLED IN SURROUNDING OBJECTS.

Arrange wiring and cables in compliance with the manual to prevent obstructions when driving. Cables or wiring that obstruct or hang up on places such as the steering wheel, gear lever, brake pedals, etc. can be extremely hazardous.

DO NOT SPLICE INTO ELECTRICAL CABLES.

Never cut away cable insulation to supply power to other equipment. Doing so will exceed the current carrying capacity of the wire and result in fire or electric shock.

DO NOT DAMAGE PIPE OR WIRING WHEN DRILLING HOLES.

When drilling holes in the chassis for installation, take precautions so as not to contact, damage or obstruct pipes, fuel lines, tanks or electrical wiring. Failure to take such precautions may result in fire.

DO NOT USE BOLTS OR NUTS IN THE BRAKE OR STEERING SYSTEMS TO MAKE GROUND CONNECTIONS.

Bolts or nuts used for the brake or steering systems (or any other safety-related system), or tanks should NEVER be used for installations or ground connections. Using such parts could disable control of the vehicle and cause fire etc.

DO NOT INSTALL IN LOCATIONS WHICH MIGHT HINDER VEHICLE OPERATION, SUCH AS THE STEERING WHEEL OR SHIFT LEVER.

Doing so may obstruct forward vision or hamper movement etc. and results in serious accident.

 **CAUTION**

This symbol means important instructions. Failure to heed them can result in injury or material property damage.

HALT USE IMMEDIATELY IF A PROBLEM APPEARS.

Failure to do so may cause personal injury or damage to the product. Return it to your authorized Alpine dealer or the nearest Alpine Service Center for repairing.

HAVE THE WIRING AND INSTALLATION DONE BY EXPERTS.

The wiring and installation of this unit requires special technical skill and experience. To ensure safety, always contact the dealer where you purchased this product to have the work done.

USE SPECIFIED ACCESSORY PARTS AND INSTALL THEM SECURELY.

Be sure to use only the specified accessory parts. Use of other than designated parts may damage this unit internally or may not securely install the unit in place. This may cause parts to become loose resulting in hazards or product failure.

ARRANGE THE WIRING SO IT IS NOT CRIMPED OR PINCHED BY A SHARP METAL EDGE.

Route the cables and wiring away from moving parts (like the seat rails) or sharp or pointed edges. This will prevent crimping and damage to the wiring. If wiring passes through a hole in metal, use a rubber grommet to prevent the wire's insulation from being cut by the metal edge of the hole.

DO NOT INSTALL IN LOCATIONS WITH HIGH MOISTURE OR DUST.

Avoid installing the unit in locations with high incidence of moisture or dust. Moisture or dust that penetrates into this unit may result in product failure.

 **NOTICE**

Product Cleaning

Use a soft dry cloth for periodic cleaning of the product. For more severe stains, please dampen the cloth with water only. Anything else has the chance of dissolving the paint or damaging the plastic.

Temperature

Be sure the temperature inside the vehicle is between +45°C (+113°F) and 0°C (+32°F) before turning your unit on.

Maintenance

If you have problems, do not attempt to repair the unit yourself. Return it to your Alpine dealer or the nearest Alpine Service Station for servicing.

Protecting the USB connector

- Only an iPhone, Android™ smartphone or USB flash drive can be connected to the USB connector on this unit. Correct performance using other USB products cannot be guaranteed.
- If the USB connector is used, be sure to use only the supplied connector cable with the unit. A USB hub is not supported.
- Depending on the connected USB flash drive, the unit may not function or some functions may not be performed.
- The audio file format that can be played back on the unit is MP3/WMA/AAC/FLAC/WAV.
- Artist/song name, etc., can be displayed. Certain, special characters may not be correctly displayed.

CAUTION

Alpine accepts no responsibility for lost data, etc., even if data, etc., is lost while using this product.

On Handling USB Flash drive

- This unit can control a memory storage device that supports the USB Mass Storage Class (MSC) protocol. Playable audio file formats are MP3, WMA, AAC, FLAC and WAV.
- USB Flash drive function is not guaranteed. Use USB flash drive according to the terms of agreement. Read the USB flash drive Owner's Manual thoroughly.
- Avoid usage or storage in the following locations: Anywhere in the car exposed to direct sunlight or high temperatures. Anywhere the possibility of high humidity or corrosive substances are present.
- Fix the USB flash drive in a location where driver operation will not be hindered.
- USB Flash drive may not function correctly at high or low temperature.
- Use only certified USB flash drive. Note that even certified USB flash drive, may not function correctly depending on its type or state.
- Depending on the settings of the USB flash drive type, memory state or encoding software, the unit may not play back or display properly.
- USB Flash drive may take time to start playback. If there is a particular file other than audio in the USB flash drive, it may take considerable time before the file is played back or searched.
- The unit can play back "mp3," "wma" or "m4a" file extensions.
- Do not add the above extensions to a file other than audio data. This non-audio data will not be recognized. The resulting playback may contain noise that can damage speakers and/or amplifiers.
- It is recommended to back up important data on a personal computer.
- Do not remove the USB device while playback is in progress. Change SOURCE to something other than USB, then remove the USB device to prevent possible damage to its memory.

- Windows Media are trademarks, or registered trademarks of Microsoft Corporation in the United States and/or other countries.
- Apple, iPhone and Siri are trademarks of Apple Inc., registered in the U.S. and other countries. Apple CarPlay is a trademark of Apple Inc.
- Use of the Made for Apple and Works with Apple badges means that an accessory has been designed to connect specifically to the Apple product(s) identified in the Made for Apple badge and to work specifically with the technology identified in the Works with Apple badge, and has been certified by the developer to meet Apple performance standards. Apple is not responsible for the operation of this device or its compliance with safety and regulatory standards.
- Please note that the use of this accessory with an Apple product may affect wireless performance.
- Use of the Apple CarPlay logo means that a vehicle user interface meets Apple performance standards. Apple is not responsible for the operation of this vehicle or its compliance with safety and regulatory standards. Please note that the use of this product with iPhone may affect wireless performance.
- Google, Android, Google Play and Android Auto are trademarks of Google LLC.
To use Android Auto on your car display, you'll need an Android Auto compatible vehicle or aftermarket stereo, an Android phone running Android 6.0 or higher, and the Android Auto app.
- The terms HDMI and HDMI High-Definition Multimedia Interface, and the HDMI Logo are trademarks or registered trademarks of HDMI Licensing LLC in the United States and other countries.
- The Bluetooth® word mark and logos are registered trademarks owned by the Bluetooth SIG, Inc. and any use of such marks by ALPS ALPINE Co., LTD. is under license. Other trademarks and trade names are those of their respective owners.
- MPEG Layer-3 audio coding technology licensed from Fraunhofer IIS and Thomson. Supply of this product only conveys a license for private, non-commercial use and does not convey a license nor imply any right to use this product in any commercial (i.e. revenue-generation) real time broadcasting (terrestrial, satellite, cable and/or any other media), broadcasting/streaming via internet, intranets and/or other networks or in other electronic content distribution systems, such as pay-audio or audio-on-demand applications. An independent license for such use is required. For details, please visit <http://www.mp3licensing.com>

Made for iPhone X, iPhone 8, iPhone 8 Plus, iPhone 7, iPhone 7 Plus, iPhone SE, iPhone 6s, iPhone 6s Plus, iPhone 6, iPhone 6 Plus, iPhone 5s

Getting Started

Location of Controls

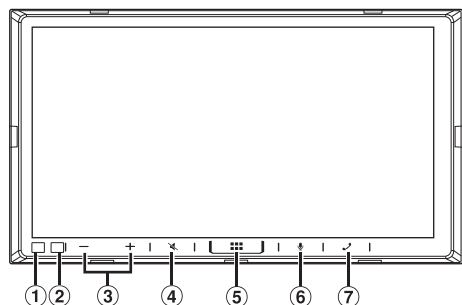

- ① **Dimmer Sensor**
Senses the brightness of the car interior.
- ② **Remote Sensor**
Point the remote control transmitter towards the remote sensor within a range of 2 meters.
- ③ **- / + (DOWN/UP) button**
Adjusts the volume.
- ④ **[Speaker icon with slash] (MUTE) button**
Activates/deactivates MUTE mode.
- ⑤ **[Square icon with four smaller squares] (HOME) button**
Displays the HOME screen.
- ⑥ **[Microphone icon] button**
Activate Siri function or voice recognition mode.
- ⑦ **[Telephone handset icon] (Phone) button**
Displays the Phone Menu screen.
Touch to start a conversation when a call is incoming.

About the button descriptions used in this Owner's Manual

The buttons found on the face of the unit are expressed in bold (e.g. **[Square icon with four smaller squares] (HOME)**). The buttons found on the touch-screen display are shown in bold within brackets, [] (e.g. **[OK]**).

Turning Power On or Off

When the ignition key is turned to ACC or ON, the opening screen will be automatically displayed.

1 Turn the ignition key to the ACC or ON position.

The unit turns on.

- When the unit is used for the first time, the Radio main screen is displayed.
- When turned on, the unit displays the last screen that was displayed before the ignition key was turned off. For example, if the unit is in radio mode when ignition is turned off, it will remain in radio mode when ignition is turned back on.

2 To turn the unit to off, turn the ignition key to the OFF position.

- *The unit is a precision device. Careful handling of the unit should provide you with years of trouble-free operation.*
- *Some of this unit's functions cannot be performed while the vehicle is in motion. Be sure to stop your vehicle in a safe location and apply the parking brake before attempting these operations.*

Adjusting the Volume

Adjust the volume by touching - / +.

Volume decreases/increases continuously by touching and holding - / +.

Volume: 0 to 35

Lowering Volume Quickly

Audio Mute function instantly lowers the volume level to 0.

1 Touch the [Speaker icon with slash] (MUTE) button to activate MUTE mode.

The audio level will be 0.

2 Touch the [Speaker icon with slash] (MUTE) button again to bring the audio back to previous volume level.

Touch Screen Operation

You can operate the unit by using the touch panel display.

- Be sure to touch the onscreen button lightly with the pad of your finger to avoid scratching the display.

Touch operation

Touch a button or list item on the screen lightly.

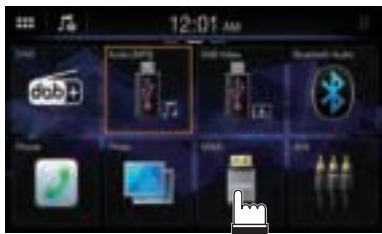

- If you touch a button and there is no reaction, remove your finger.
- Onscreen buttons that cannot be operated are dimmed.

Swipe operation

Move your finger lightly with a swipe.

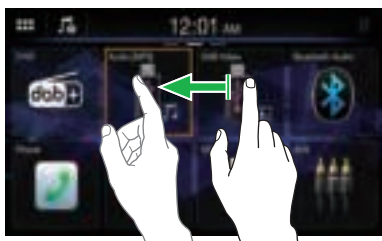

Drag & Drop operation

Touch and hold the desired item, then drag it to its new location by moving your finger, then release your finger to place the item.



- Except for USB Photo mode, it is not possible to narrow the screen with two fingers (pinch in) or spread the screen (pinch out).

Switching Sources

1 Touch the (HOME) button.

The HOME screen is displayed.



2 Touch a widget of your desired source.

- In the HOME screen, you can change the widget location on the screen. For details, see "About the HOME Screen" (page 11).

Selecting an Item in a List

To scroll through a list, perform the following operations.

Touch the screen and slide your finger up and down.

The screen will scroll along with your finger movement.

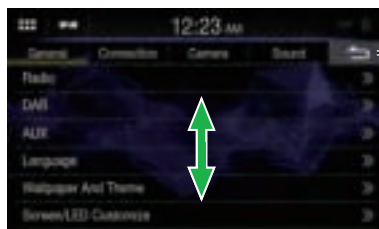

Returns to the previous screen. Depending on the function, this button may cancel the operations performed on the screen.

- After touching the screen, move your finger away from the screen before dragging and that item will be selected.

About the HOME Screen

In the HOME screen, select a widget to perform various settings and operations of the function.

Touch the (HOME) button.

The HOME screen is displayed.

- You can also display the HOME screen by touching [] at the top of the screen.

■ HOME screen example

HOME screen navigation

Swipe the HOME screen horizontally with your finger to change the page. Up to 3 pages exist.

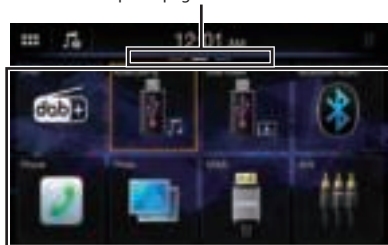

Widget

Touch to activate the function.

- After selecting [Audio] widget, it is possible to switch the mode to USB Audio mode, iPod mode for iPhone or Bluetooth Audio mode.

Editing HOME screen

You cannot operate the Widgets editing screen while driving.

Your vehicle must be parked with the ignition key in the ACC or ON position. For details, see "To display the Setup Menu screen" in "Setup Operation" (page 12).

In the Widgets editing screen, you can change the audio source order or set the display/hide settings.

1 Touch and hold the HOME screen for at least a second.

The widgets editing screen is displayed.

HOME screen image

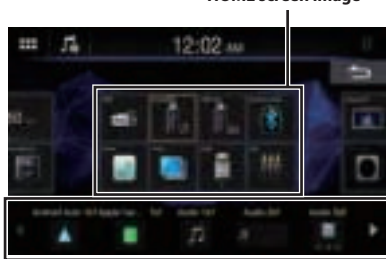

Additional candidate widgets

- The source icon displayed in the Widgets editing screen is displayed only when usable setup and conditions of each Audio source are fulfilled. For details on setup and conditions of each audio source, see "Switching Sources" (page 10).

■ Adding a widget

Drag and drop a widget from the additional candidate widgets area to the desired position of the HOME screen image area.

- To show more candidate widgets, swipe horizontally.
- There are 3 sizes of widgets.

■ Changing the order of widget

Drag and drop the widget to the desired location.

■ Deleting a widget from the HOME screen

Drag and drop a widget from the HOME screen image area to .

-  is displayed while touching a widget.

2 Touch the (HOME) button.

The HOME screen is displayed.

About the Indicator Display

The Indicator Bar at the top of the screen displays various types of information, like the current time.



- 1 Recalls the HOME screen.
- 2 Displays the currently playing audio source. Touch to return to the Audio source screen.
- 3 Indicates the current time. You can switch between the 12 hour display and 24 hour display options (page 16).
- 4 Displays the DAB signal strength.
- 5 Lights up when connected to a Bluetooth compatible device. (Does not display when connection is set to OFF.)

Setup

Setup Operation

1 Touch the (HOME) button.

The HOME screen is displayed.



[Settings] button

2 Touch [Settings].

The Settings menu screen is displayed.

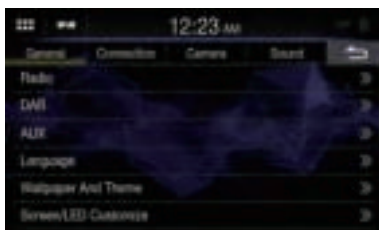

3 Touch the required setting genre on the upper part of the Settings menu screen, and then touch the setting item.

Setting genres:

General: See "General Setup" (page 13).

Connection: See "Connection (Bluetooth) Setup" (page 18).

Camera: See "Camera Setup" (page 20).

Sound: See "Sound Setup" (page 22).

General Setup

[General] is selected on the Settings menu screen.

■ General Setup Menu screen

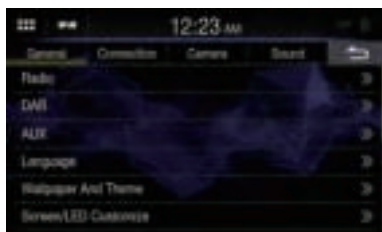

Setting items:

- Radio (page 13)
- DAB (page 14)
- AUX (page 15)
- Language (page 15)
- Wallpaper And Theme (page 15)
- Screen/LED Customize (page 16)
- Date/Clock (page 16)
- Display Off (page 16)
- About (page 17)
- Installation (page 17)
- Steering Wheel Position (page 17)
- Mute While Backing Up (page 17)
- CAN I/F BOX (page 18)

Radio Setup

[Radio] is selected on the General Setup Menu screen.

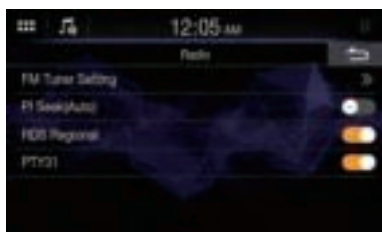

Setting the TUNER (FM) Tone Quality (Tuner Condition)

This unit can set your preferred tone quality for FM radio source.

Setting item:

FM Tuner Setting

Setting contents:

Normal (Initial setting) / HiFi / Stable

Normal: Standard setting

HiFi: High-quality setting

Stable: Control noise

- Noise may be more noticeable when [HiFi] is set, depending on the reception status. In this case, the [Normal] setting is recommended.

PI SEEK Setting

Setting item:

PI Seek (Auto)

Touch [] (Off) or [] (On) of "PI Seek (Auto)".

Receiving RDS Regional (Local) Stations

When Off is selected, the unit automatically keeps receiving the local RDS station.

Setting item:

RDS Regional

Touch [] (Off) or [] (On) of "RDS Regional".

Setting PTY31 (Emergency Broadcast) Reception

PTY31 (Emergency Broadcast) reception can be set to On/Off.

Setting item:

PTY31

Touch [] (Off) or [] (On) of "PTY31".

- The unit automatically gives priority to an emergency broadcast whenever it begins, and interrupts the programme you are currently listening to when PTY31 is set to "On".
- The unit will show "Alarm" in the display during PTY31 reception.
- This setting works with the Alarm (Emergency Broadcast) of DAB.

DAB Setup

[DAB] is selected on the General Setup Menu screen.

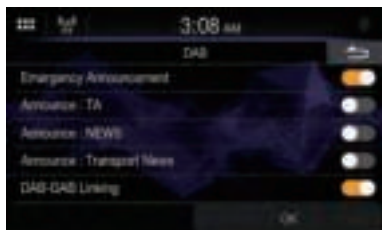

Setting Emergency Announcement Reception

Turn Emergency Announcement reception On/Off.

Setting item:

Emergency Announcement

Touch [] (Off) or [] (On) of “Emergency Announcement”.

- This setting works with PTY31 (Emergency Broadcast) of RDS.
- When an emergency broadcast is received, the volume level will be automatically changed to the memorized level in the traffic information mode. For details, see “Receiving Traffic Announcement” (page 32).

Setting Announcement Reception

You can select your desired station from 3 announcement types.

If “On” is set, when the selected announcement is received, the unit will switch to the DAB source screen automatically and will receive the broadcast.

Setting item:

Announce: TA / NEWS / Transport News

Touch [] (Off) or [] (On) of the desired announcement.

Setting the DAB-DAB Linking ON/OFF (Service Following)

This unit provides DAB-DAB Linking function which can switch the source from DAB to the same channel in another channel group with better reception when the digital signal is weak.

Setting item:

DAB-DAB Linking

Touch [] (Off) or [] (On) of “DAB-DAB Linking”.

Setting the DAB-FM Linking ON/OFF (Service Following)

This unit provides DAB-FM Linking function which can switch the source from DAB to FM radio when the digital signal is weak.

Setting item:

DAB-FM Linking

Touch [] (Off) or [] (On) of “DAB-FM Linking”.

Setting the DAB Antenna ON/OFF

You can choose whether to supply power to DAB Antenna Connector by this setting. Confirm the type of DAB Antenna (sold separately) before installing the DAB antenna. If an active antenna that needs power supply from this unit is used, set DAB Antenna Power to On; if a passive antenna that does not need power supply from this unit is used, make sure to set DAB Antenna Power to Off, otherwise, a malfunction may occur.

Setting item:

DAB Antenna Power

Touch [] (Off) or [] (On) of “DAB Antenna Power”.

- If the “DAB Antenna error.” message is displayed on the unit, this setting becomes invalid. For details on what to do if “DAB Antenna error,” is displayed, see “If this Message Appears” (page 57).

AUX Setup

[AUX] is selected on the General Setup Menu screen.

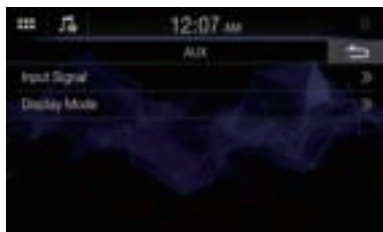

Setting the Input Signal

The video input signal type can be chosen.

Setting item:

Input Signal

Setting contents:

NTSC (Initial setting) / PAL

Setting the Display Mode

You can switch the Display Mode of the video file to be played.

Setting item:

Display Mode

Setting contents:

Full (Initial setting) / 4.3

Language Setup

[Language] is selected on the General Setup Menu screen. The Setup menu, feedback information, etc. for this unit can be changed to appear in the selected language.

Setting item:

Language

Setting contents:

English (Initial setting) / Deutsch / Français / Español / Italiano / Português / Polski / Nederlands / Dansk / Suomi / Norsk / Svenska / Slovenčina / Čeština / Magyar / Ελληνικά / Türkçe / русский / תיבוע

- The currently selected language is displayed.

Wallpaper Setup

[Wallpaper And Theme] is selected on the General Setup Menu screen.

You can change the wallpaper of the display screen from 4 different coloured default images or your image.

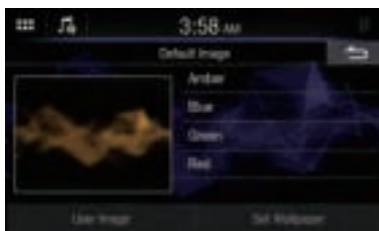

Setting a Wallpaper using a default image

Setting contents:

Amber / Blue / Green / Red

Touch the desired image, and then touch [Set Wallpaper].

Setting a Wallpaper using your image

1 Touch [User Image].

The image selecting screen is displayed.

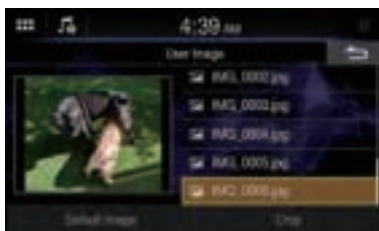

2 Select an image stored on the connected USB Flash drive.

The selected image thumbnail is displayed.

If not using an image as a wallpaper, touch [Default Image] to return to the previous screen without selecting.

3 Touch [Crop].

4 Touch the area to be trimmed for a wallpaper.

If the image is 800 × 480 pixel, this step is not necessary.

5 Touch [Set Theme] to change the theme colour.

6 Touch the desired colour.

7 Touch [Set Wallpaper].

Screen/LED Customize Setup

[Screen/LED Customize] is selected on the General Setup Menu screen.

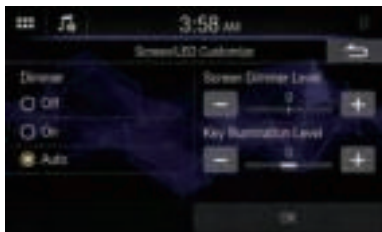

Setting item:

Dimmer / Screen Dimmer Level / Key Illumination Level

Setting the Brightness of the Backlighting (Dimmer)

Backlighting is provided by LEDs light built into the liquid crystal panel. The illumination control adjusts the brightness of the backlighting based on the car ambient lighting for easier viewing.

Setting item:

Dimmer

Setting contents:

Off / On / Auto (Initial setting)

- Off: Deactivate Auto Dimmer mode to keep the background illumination of the monitor bright.
- On: Keep the background illumination of the monitor dark.
- Auto: Adjust the brightness of the background illumination of the monitor automatically to the brightness of the car interior.

- When [On] is set, the setting is also applied for the button lighting in "Adjusting the Dimmer of Button Lighting at Night" (page 16) and "Adjusting the Minimum Level of Backlight" (page 16).

Adjusting the Minimum Level of Backlight

You can adjust the brightness of the backlight. This function could be used, for instance, to change the screen brightness while traveling at night.

Setting item:

Screen Dimmer Level

Setting contents:

-15 to 15 (Initial setting: 0)

- This setting is only available when "Dimmer" is set to [On] or [Auto].

Adjusting the Dimmer of Button Lighting at Night

You can adjust the brightness of the button lighting at night with the dimmer.

Setting item:

Key Illumination Level

Setting level:

-2 to 2 (Initial setting: 0)

- This setting is only available when "Dimmer" is set to [On] or [Auto].

Date/Clock Setup

[Date/Clock] is selected on the General Setup Menu screen. You can set the display type of the Date/Clock adjustment and the clock display to 12-hours or 24-hours, depending on your preference.

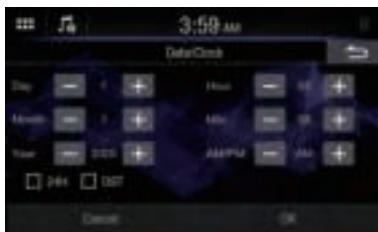

Setting item:

Date/Clock

Touch [+] or [-] to adjust the day, month, year, hour, minute and AM/PM.

- To change to 24-hour, set "24H" to [On] (☑).
- To set the daylight saving time (Summer Time mode), set "DST" to [On] (☑).

Display Off Setting

When [Display Off] is selected on the General Setup Menu screen, the display is turned off.

Setting item:

Display Off

- To cancel Display Off mode, touch the screen or any button.
- Display Off mode is canceled when the power or ACC is turned off.
- When the gear lever is shifted to the reverse (R) position and the rear camera is connected, the rear camera image is displayed.
- When a call is received on a Bluetooth-connected phone, the incoming call screen is displayed.
- You can also activate Display Off mode directly by touching the [Display Off] widget on the HOME screen.

About iLX-W690D

[**About**] is selected on the General Setup Menu screen. [**About**] enables you to check the Serial No., Firmware Version, Model Name, and to initialize various settings.

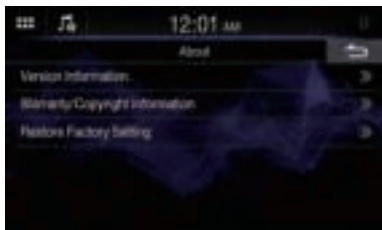

Displaying the Product Information

You can view the version information of this product. Make note of this information and refer to it whenever you contact Alpine Tech Support or an Alpine-authorized dealer.

Setting item:

Version Information

Setting contents:

Serial No. / SYSTEM version / Firmware Version

Displaying Warranty/Copyright Information

Setting item:

Warranty/Copyright Information

Setting contents:

Open source licenses / Notice

Initializing the System

You can initialize all data, to restore the factory settings. Remove the USB flash drive, etc. from the system before operation.

- 1 Touch [Restore Factory Setting].**
- 2 After the confirmation message appears, touch [Yes].**

The confirmation screen appears.
- 3 Touch [Confirm].**

The system starts initialization.

- Do not turn on/off the power, change the ignition key position or remove the screen panel until system restart is completed.

Installation Setup

[**Installation**] is selected on the General Setup Menu screen.

Vehicle Setup enables you to check the connection status of Reverse Lead/Parking Brake Lead.

When selecting the item, the Installation check screen is displayed.

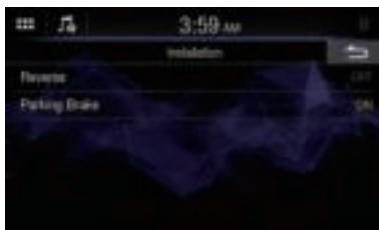

Setting item:

Installation

Setting contents:

Reverse / Parking Brake

Steering Wheel Position Setting

[**Steering Wheel Position**] is selected on the General Setup Menu screen.

Set this item when Apple CarPlay is used/Android smartphone which installed Android Auto App is connected.

This setting influences Apple CarPlay/Android Auto mode.

Setting item:

Steering Wheel Position

Setting contents:

Left (Initial setting) / Right

Mute Setting

[**Mute While Backing Up**] is selected on the General Setup Menu screen.

You can set the sound will be muted automatically when the gear lever is moved to the reverse (R) position.

Setting item:

Mute While Backing Up

Touch [] (Off) or [] (On) of "Mute While Backing Up".

CAN I/F BOX Setting

[CAN I/F BOX] is selected on the General Setup Menu screen.

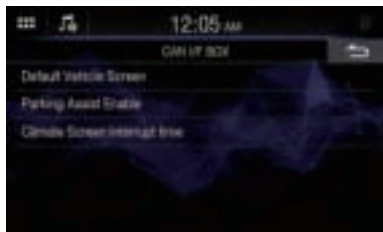

Setting the Default Vehicle Screen

You can set the Default Vehicle Screen displayed in CAN I/F BOX mode.

Setting item:

Default Vehicle Screen

Setting contents:

Climate / Parking Assist / Last Mode (Initial setting)

- Depending on the car, some setting contents or this setting item may not be displayed.

Setting the Parking Assist Enable

You can set up the camera for Parking Assist.

Setting item:

Parking Assist Enable

Touch [] (Off) or [] (On) of "Parking Assist Enable".

Setting the Climate Screen Interrupt Time

You can set the time displayed in the Climate screen.

Setting item:

Climate Screen Interrupt Time

Setting contents:

None / 5 sec (Initial setting) / 10 sec / Continuous Display

None: The Climate screen is not displayed when you adjust the air conditioner, etc.

5 sec/10 sec*: The screen is displayed for 5 seconds/10 seconds, then returns to the previous screen.

Continuous display: The Climate screen is continuously displayed.

- * If you set the air conditioner, etc., while the Climate screen is displayed, the screen will continuously be displayed.

Connection (Bluetooth) Setup

[Connection] is selected on the Setup menu screen.

■ Connection Setup Menu screen

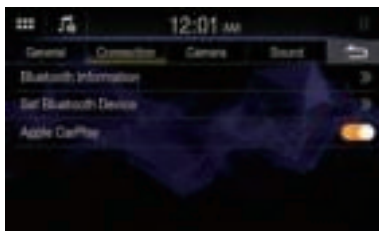

Setting items:

Bluetooth Information (page 18)

Set Bluetooth Device (page 18)

Apple CarPlay (page 19)

Displaying Bluetooth Information

[Bluetooth Information] is selected on the Connection Setup Menu screen.

You can display the Bluetooth device name and device address of this unit.

Setting item:

Bluetooth Information

Pairing the Bluetooth Device

[Set Bluetooth Device] is selected on the Connection Setup Menu screen.

Search for Bluetooth compatible devices.

Setting item:

Set Bluetooth Device

1 Touch [Set Bluetooth Device].

The Bluetooth Setup screen is displayed.

- You can also display the Bluetooth Setup screen directly by touching the [Bluetooth Settings] widget on the HOME screen.

2 Select this unit on the Bluetooth device.

A message about the device to be registered is displayed.

3 Touch [Yes].

The Bluetooth device is connected.

If you connecting to a smartphone, a message to download the phonebook is displayed.

4 Touch [🎵] (Audio) or/and [📶] (Hands-free) of the device you want to connect from the list.

Audio: Device is used as an Audio device.
Hands-free: Device is used as a Hands Free Device.

- You can register up to 5 Bluetooth compatible mobile phones.
- You can connect 1 Bluetooth Device to each of Bluetooth Audio mode and Hands-free mode.
- *The Bluetooth registration process differs depending on the device version and SSP (Simple Secure Pairing). If a 4 or 6 character Passcode appears on this system, enter the Passcode on the Bluetooth device.*
- *If a 6 character Passkey appears on this device, make sure the same passkey is displayed on the Bluetooth compatible device and touch [OK].*
- *If all 5 devices have been registered, you cannot register a 6th device. To register another device, you need to delete one of the other 5 devices first.*

Setting the Bluetooth Device

Select one of 5 paired Bluetooth compatible devices that you previously registered.

Touch [🎵] (Audio) or [📶] (Hands-free) of the device you want to connect from the Paired Device list.

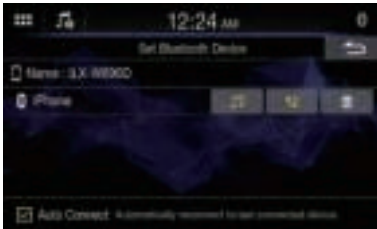

- You can also change the connected device by touching the device name.

Deleting a Bluetooth Device from the list

You can delete the information of a previously connected Bluetooth compatible device.

1 Touch [🗑️] of the Bluetooth compatible device to delete from the Paired Device list.

2 Touch [Yes].

- Touching [No] will cancel the setting.

Setting the Auto Connection

You can connect the last connected device automatically.

Set "Auto Connect" to [On] (☑).

Apple CarPlay Setup

[Apple CarPlay] is selected on the Connection Setup Menu screen.

To use the Apple CarPlay (page 29), set "Apple CarPlay" to [On].

Setting item:
Apple CarPlay

Touch [🔴] (Off) or [🟢] (On) of "Apple CarPlay".

Camera Setup

[**Camera**] is selected on the Setup Menu screen. You can set up items related to the Camera.

■ Camera Setup Menu screen

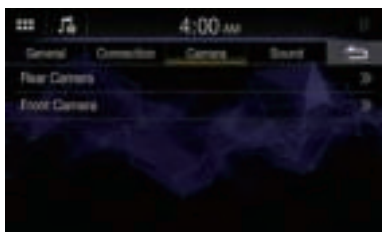

Setting items:

- Rear Camera (page 20)
- Front Camera (page 21)

Rear Camera Setup

[**Rear Camera**] is selected on the Camera Setup Menu screen.

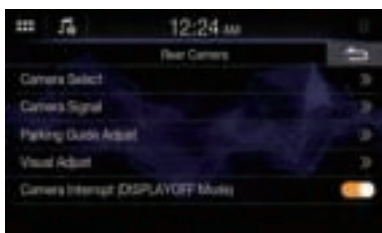

Camera Input Setting

[**Camera Select**] is selected on the Camera Setup Menu screen.

Setting item:

- Camera Select

Setting contents:

Off (Initial setting) / Rear

- Off: No camera is connected.
- Rear: Rear camera is connected.

Camera Signal Input Setting

[**Camera Signal**] is selected on the Camera Setup Menu screen.

When the camera is connected, the video input signal type can be chosen.

Further setting item:

- Camera Signal

Setting contents:

NTSC (Initial setting)/PAL

Rear Camera Guide Settings

[**Parking Guide Adjust**] is selected on the Camera Setup Menu screen.

You can adjust the camera guide position.

Setting item:

- Parking Guide Adjust

1 Touch [Parking Guide Adjust] on the Camera Setup menu screen.

The camera guide adjustment screen is displayed.



2 Slide [○] to adjust.

3 After the adjustment is completed, touch [Save].

- Touching [Init.] clears adjustments and returns to the setting before guide line alteration.

4 Touch [↩] to complete the adjustment and return to the previous screen.

Turning the Rear Camera Guide On/Off

When displaying the rear camera view on the screen, you can set to hide or show the camera guide.

Setting item:

- Guide On/Off

Setting contents:

Off / On

Adjusting the Caution Position

You can move the position of the displaying message on the screen.

Setting item:

- Caution ▲▼

Camera Picture Quality Setup

[**Visual Adjust**] is selected on the Camera Setup Menu screen.

You can adjust the picture quality for the primary and secondary cameras.

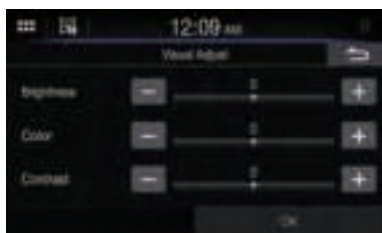

Setting item:

Visual Adjust

Adjusting Brightness

Setting item:

Brightness

Setting contents:

-15 to 15 (Initial setting: 0)

- You can adjust the brightness between MIN (-15) and MAX (+15).

Adjusting Colour of Display

Setting item:

Color

Setting contents:

-15 to 15 (Initial setting: 0)

- You can adjust the colour between MIN (-15) and MAX (+15).

Adjusting Display Contrast

Setting item:

Contrast

Setting contents:

-15 to 15 (Initial setting: 0)

- You can adjust the contrast between MIN (-15) and MAX (+15).

Camera Interrupt Setting (DISPLAY OFF Mode)

You can set whether to display the rear camera image when the gear lever is moved to the reverse (R) position while the unit is turned off.

Setting item:

Camera Interrupt (DISPLAYOFF Mode)

Touch [] (Off) or [] (On) of "Camera Interrupt (DISPLAYOFF Mode)".

Front Camera Setup

[**Front Camera**] is selected on the Camera Setup Menu screen.

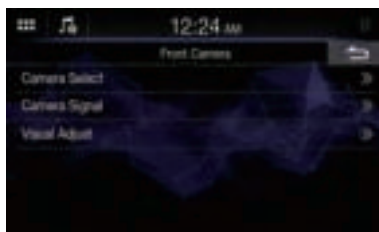

Camera Input Setting

[**Camera Select**] is selected on the Camera Setup Menu screen.

Setting item:

Camera Select

Setting contents:

Off (Initial setting) / Front

Off: No camera is connected.

Front: Front camera is connected.

Camera Signal Input Setting

[**Camera Signal**] is selected on the Camera Setup Menu screen.

When the camera is connected, the video input signal type can be chosen.

Further setting item:

Camera Signal

Setting contents:

NTSC (Initial setting)/PAL

Camera Picture Quality Setup

[**Visual Adjust**] is selected on the Camera Setup Menu screen.

You can adjust the picture quality for the primary and secondary cameras.

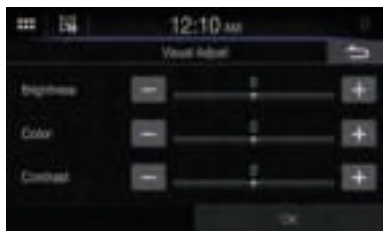

Setting item:

Visual Adjust

Adjusting Brightness

Setting item:

Brightness

Setting contents:

-15 to 15 (Initial setting: 0)

- You can adjust the brightness between MIN (-15) and MAX (+15).

Adjusting Colour of Display

Setting item:

Color

Setting contents:

-15 to 15 (Initial setting: 0)

- You can adjust the colour between MIN (-15) and MAX (+15).

Adjusting Display Contrast

Setting item:

Contrast

Setting contents:

-15 to 15 (Initial setting: 0)

- You can adjust the contrast between MIN (-15) and MAX (+15).

Sound Setup

[**Sound**] is selected on the Settings menu screen.

You can set up items related to the sound quality.

■ Sound Setup Menu screen

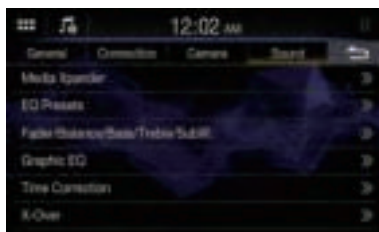

Setting items:

Media Xpander (page 22)

EQ Presets (page 23)

Fader/Balance/Base/Treble/SubW. (page 23)

Graphic EQ (page 24)

Time Correction (page 24)

X-Over (page 25)

Volume (page 25)

Subwoofer (page 26)

Rear Speaker (page 26)

Defeat (page 26)

Setting the Media Xpander (MX)

[**Media Xpander**] is selected on the Sound Setup Menu screen.

Media Xpander (MX) makes vocals or instruments sound distinct regardless of the music source. The Radio (FM), DAB, USB Flash drive and iPod, will be able to reproduce the music clearly even in cars with a lot of road noise.

Setting item:

Media Xpander

1 Touch the check box of [ALL MX].

2 Touch any of [Off] [Level 1] [Level 2] [Level 3].

- To cancel MX mode, set [Off] in step 1.
- MP3/WMA/AAC can have its own MX setting.
- When the Defeat setting is [On], you cannot perform the set up.
- The MX setting can be performed only when a source is currently selected.

Equalizer Settings

[EQ Presets] is selected on the Sound Setup Menu screen. 10 typical equalizer settings are preset at the factory for a variety of musical source material.

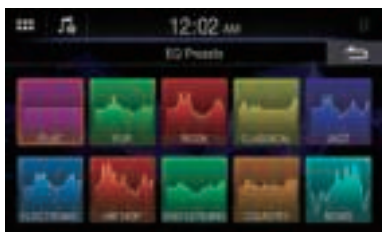

Setting item:

EQ Presets

Setting contents:

FLAT (Initial setting) / POP / ROCK / CLASSICAL / JAZZ / ELECTRONIC / HIP HOP / EASY LISTENING / COUNTRY / NEWS

- Only one type can be set to On.
- When Equalizer Presets is set, the linked Graphic EQ settings are also changed. We recommend storing Graphic EQ settings in a Preset in advance.
- The Equalizer Presets setting can be configured when Defeat is Off.

Fader/Balance/Bass/Treble/ Subwoofer Settings

[Fader/Balance/Bass/Treble/SubW.] is selected on the Sound Setup Menu screen.

Setting item:

Fader/Balance/Bass/Treble/SubW.



- 1 Cancel
Sound setup finishes.
- 2 Fader/Balance Image area

Setting the Fader/Balance

Touch the desired point within the image area, or touch [F] (Front), [R] (Rear), [L] (Left) or [R] (Right).

Fader:

15 (F) to 15 (R)

Balance:

15 (L) to 15 (R)

- To reset to the initial setting (F/R: 0, L/R: 0), touch [].

Adjusting the Bass/Treble

Touch [+] or [-] for each item to be adjusted.

Setting item:

Bass, Treble

Setting contents:

-10 to 10 (Initial setting: 0)

Setting the Subwoofer

Adjusting the Subwoofer Level

Setting item:

Sub W.Level

Setting contents:

0 (Initial setting) to 15

- This setting is only available when "Subwoofer" is set to [On] (page 26).

Setting the Subwoofer Phase

The subwoofer output phase is toggled Subwoofer Normal (0°) or Subwoofer Reverse (180°).

Setting item:

Sub W.Phase

Setting contents:

0° (Initial setting), 180°

- This setting is only available when "Subwoofer" is set to [On] (page 26).

Graphic Equalizer Curve Settings (Graphic EQ)

[**Graphic EQ**] is selected on the Sound Setup Menu screen. You can modify the Equalizer settings to create a response curve more appealing to your personal taste.

Setting item:

Graphic EQ

Setting contents:

-7 to 7

- This setting is only available when “Defeat” is set to [On] (page 26).

1 Touch [Graphic EQ] on the Sound Setup menu screen.

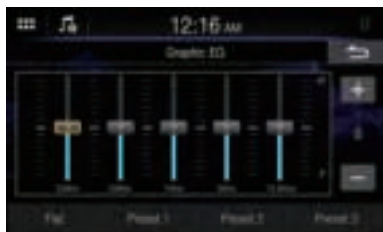

- 2 Touch the band to be adjusted.**
- 3 Touch [+] or [-] to adjust the level of the band.**
 - You can also adjust the level of the band by moving the slider.
- 4 To adjust another band, repeat step 2 to 3, and adjust all bands.**
- 5 To store the adjusted setting value, touch and hold [Preset 1], [Preset 2], or [Preset 3] for at least 2 seconds.**

- Settings exceeding the frequency of adjacent bands are not available.
- While adjusting the Graphic EQ, you should consider the frequency response of the connected speakers.
- When the Graphic EQ is adjusted, the Equalizer Presets are overridden.
- When Equalizer Presets is set, the linked Graphic EQ settings are also changed. We recommend storing Graphic EQ settings in a Preset in advance.
- Touch [Flat] to initialize all values.

Calling the Graphic EQ adjusted value

Touch [Preset 1], [Preset 2], or [Preset 3].

The setting stored in the Preset will be recalled.

Time Correction Settings

[**Time Correction**] is selected on the Sound Setup Menu screen.

Before performing the following procedures, see “About Time Correction” (page 27).

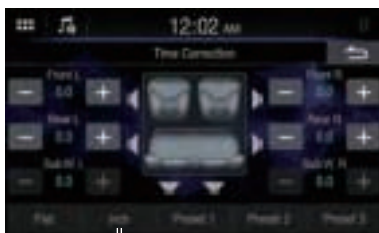

Correction mode

Setting item:

Time Correction

- 1 Touch [Time Correction] on the Sound Setup menu screen.**
- 2 Touch the Correction mode button, and then select [ms], [cm] or [inch].**
- 3 Touch [-] or [+] for each speaker to adjust the time or distance.**
 - 0.0 msec to 9.9 msec (0.1 msec/step)
 - 0.0 cm (0.0 inch) to 336.6 cm (132.56 inch) (3.4 cm/step)
 - All speaker setting values are adjustable in the range of 20 ms or 680 cm.
- 4 To store the adjusted setting value, touch and hold [Preset 1], [Preset 2], or [Preset 3] for at least 2 seconds.**

- Touch [Flat] to set all values to 0.0.
- If the Rear Speaker setting is Off, the Rear Speaker setting cannot be edited (page 26).
- If the Subwoofer setting is Off, the Subwoofer setting cannot be edited (page 26).

Calling the Time Correction Value

Calling the pre-set time correction value.

Touch [Preset 1], [Preset 2], or [Preset 3] on the time correction screen.

The setting stored in the Preset will be recalled.

Crossover Settings (X-Over)

[X-Over] is selected on the Sound Setup Menu screen. Before performing the following procedures, see "About the Crossover" (page 27).



Setting item:
X-Over

- 1 Touch [X-Over] on the Sound Setup menu screen.
- 2 Touch [Channel], and then select [Front HPF], [Rear HPF] or [SubW.LPF].
- 3 Adjust the crossover to your preference.

Selecting the Cut-Off Frequency

Touch [◀] or [▶] of "Freq." (Frequency), and then select the cut-off frequency.

Setting contents:
20.0 / 25.0 / 31.5 / 40.0 / 50.0 / 63.0 / 80.0 (Initial setting) / 100.0 / 125.0 / 160.0 / 200.0 Hz

Adjusting the Slope

Touch [◀] or [▶] of "Slope", and then adjust the HPF or LPF slope.

Setting contents:
0 (Initial setting) / 6 / 12 / 18 / 24 dB/oct.

Adjusting the Level

Touch [−] or [+] of "Level", and then adjust the HPF or LPF level.

Setting contents:
−12 to 0 dB (Initial setting: 0)

- 4 Repeat steps 2 to 3 to make adjustment to the other channels.
- 5 To store the adjusted setting value, touch and hold [Preset 1], [Preset 2], or [Preset 3] for at least 2 seconds.

- Touch [Flat] to initialize all values.
- If the Rear Speaker setting is Off, the Rear Speaker setting cannot be edited (page 26).

- If the Subwoofer setting is Off, the Subwoofer setting cannot be edited (page 26).
- While adjusting the X-Over you should consider the frequency response of the connected speakers.

Calling the X-Over adjusted value

Touch [Preset 1], [Preset 2], or [Preset 3].

The setting stored in the Preset will be recalled.

Volume Setup

[Volume] is selected on the Sound Setup menu screen.

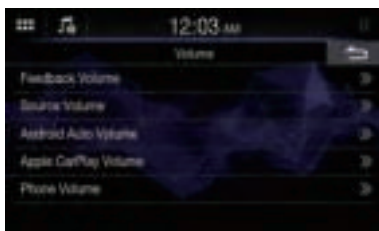

Setting items:
Feedback Volume (page 25)
Source Volume (page 26)
Android Auto™ Volume (page 26)
Apple CarPlay Volume (page 26)
Phone Volume (page 26)

- *Settable source differs depending on the connected device and settings.*

Adjusting the Key Sound

You can change the volume of the sound heard when a button is touched.

Setting item:
Feedback Volume

Setting contents:
0 to 7 (Initial setting: 4)

Adjusting the Source Volume

Touch **[Source Volume]** on the Volume Setup menu screen.

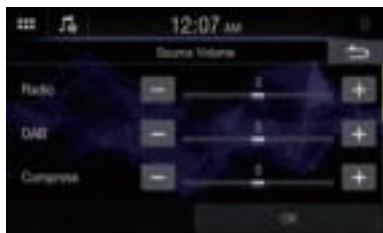

Setting item:

Radio / DAB / Compress* / iPod / Bluetooth Audio / HDMI / AUX

Setting contents:

-5 to +5 (Initial setting: 0)

* Compressed Media is the music data in a USB flash drive (MP3/WMA/AAC/FLAC/WAV).

Setting the Volume for Android Auto™

When an Android Smartphone is connected, touch **[Android Auto Volume]** to set the volume for Android Auto mode.

Setting item:

Entertainment / Notification

Setting contents:

Entertainment: -5 to +5 (Initial setting: 0)
Notification: 0 to 35 (Initial setting: 10)

Setting the Volume for Apple CarPlay

When an iPhone 5s or later is connected, touch **[Apple CarPlay Volume]** to set the volume for Apple CarPlay mode.

Setting item:

Entertainment / Notification / Ringtone / Phone Calls

Setting contents:

Entertainment: -5 to +5 (Initial setting: 0)
Notification: 0 to 35 (Initial setting: 10)
Ringtone: 0 to 11 (Initial setting: 5)
Phone Calls: 0 to 11 (Initial setting: 5)

Adjusting the Volume for Phone

You can adjust the speaker volume and receive volume, during the call.

Setting item:

Speaker Volume / Mic Level / Ringtone Volume

Setting contents:

Speaker Volume: 0 to 11 (Initial setting: 5)
Mic Level: 1 to 11 (Initial setting: 7)
Ringtone Volume: 0 to 11 (Initial setting: 5)

Turning Subwoofer ON/OFF

If an optional subwoofer is connected to the unit, make the following setting.

Setting item:

Subwoofer

Touch [] (Off) or [] (On) of "Subwoofer".

Rear Speaker Setting

You can set the rear speaker output to Off.

Setting item:

Rear Speaker

Touch [] (Off) or [] (On) of "Rear Speaker".

Defeat Setting

If Defeat is On, the Equalizer setting are turned Off. This disables any settings made for these functions.

Setting item:

Defeat

Touch [] (Off) or [] (On) of "Defeat".

About the Crossover

Crossover (X-Over):

This unit is equipped with an active crossover. The crossover limits the frequencies delivered to the outputs. Each channel is controlled independently. Thus, each speaker pair can be driven by the frequencies for which they have been optimally designed.

The crossover adjusts the HPF (high pass filter) or LPF (low pass filter) of each band, and also the slope (how fast the filter rolls off the highs or lows).

Adjustments should be made according to the reproduction characteristics of the speakers. Depending on the speakers, a passive network may not be necessary. If you are unsure about this point, please consult your authorized Alpine dealer.

	Cut-off frequency (1/3 octave steps)		Slope		Level
	HPF	LPF	HPF	LPF	
Subwoofer (LPF)	----	20 Hz - 200 Hz	----	0, 6, 12, 18, 24 dB/oct.	0 to -12 dB
Rear speaker (HPF)	20 Hz - 200 Hz	----	0, 6, 12, 18, 24 dB/oct.	----	0 to -12 dB
Front speaker (HPF)	20 Hz - 200 Hz	----	0, 6, 12, 18, 24 dB/oct.	----	0 to -12 dB

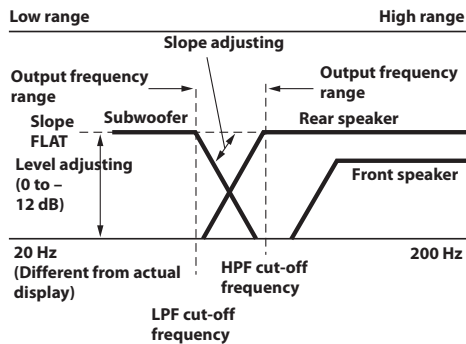

- **HPF (high pass filter):** Cuts the lower frequencies and allows the higher frequencies to pass.
- **LPF (low pass filter):** Cuts the higher frequencies and allows the lower frequencies to pass.
- **Slope:** The level change (in dB) for a frequency change of one octave.
- The higher the slope value, the steeper the slope becomes.
- Adjust the slope to FLAT to bypass the HP or LP filters.
- Do not use a tweeter without the HPF on or set to a low frequency, as it may cause damage to the speaker due to the low frequency content.

- Adjustment should be made according to the recommended crossover frequency of the connected speakers. Determine the recommended crossover frequency of the speakers. Adjusting to a frequency range outside that recommended may cause damage to the speakers.

For the recommended crossover frequencies of Alpine speakers, refer to the respective Owner's Manual.

We are not responsible for damage or malfunction of speakers caused by using the crossover outside the recommended value.

About Time Correction

The distance between the listener and the speakers in a car vary widely due to the complex speaker placement. This difference in the distances from the speakers to the listener creates a shift in the sounds image and frequency characteristics. This is caused by the time delay between the sound reaching the listener's right versus the left ear.

To correct this, this unit is able to delay the audio signal to the speakers closest to the listener. This effectively creates a perception of increased distance for those speakers. The listener can be placed at an equal distance between the left and right speakers for optimum staging.

The adjustment will be made for each speaker in 3.4 cm steps.

Example 1. Listening Position: Front Left Seat

Adjust the time correction level of the front left speaker to a high value and the rear right to zero or a low value.

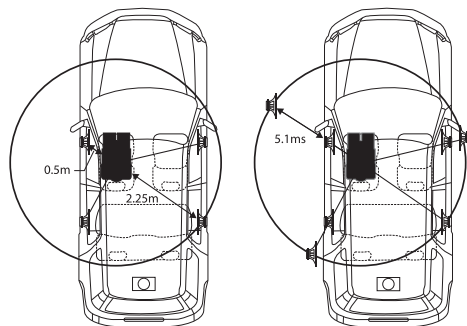

The sound is not balanced because the distance between the listening position and the various speakers is different. The difference in distance between the front left speaker and the rear right speaker is 1.75 m (68-7/8"). Here we calculate the time correction value for the front left speaker in the diagram on the above.

Conditions:

Farthest Speaker – listening position : 2.25 m (88-9/16")

Front left speaker – listening position : 0.5 m (19-11/16")

Calculation: $L = 2.25 \text{ m} - 0.5 \text{ m} = 1.75 \text{ m}$ (68-7/8")

Time correction = $1.75 \div 343 \times 1,000 = 5.1 \text{ (ms)}$

* Speed of sound: 343 m/s (765 mph) at 20°C

In other words, giving the front left speaker a time correction value of 5.1 ms makes it seem as if its distance from the listener is the same as the distance to the farthest speaker.

Time correction eliminates the differences in the time required for the sound to reach the listening position. The time of the front left speaker is corrected by 5.1 ms so that its sound reaches the listening position at the same time as the sound of other speakers.

Example 2. Listening Position: All Seats

Adjust the time correction level of each speaker to almost the same level.

- 1 Sit in the listening position (driver's seat, etc.) and measure the distance (in meters) between your head and the various speakers.**
- 2 Calculate the difference between the distance correction value to the farthest speaker and the other speakers.**

$$L = (\text{distance to farthest speaker}) - (\text{distance to other speakers})$$

These values are the time correction values for the different speakers. Setting these values to make each sound reach the listening position at the same time as the sound of other speakers.

Time Correction Value List

Time Difference (msec)	Distance (cm)	Distance (inch)	Time Difference (msec)	Distance (cm)	Distance (inch)
0.0	0.0	0.0	5.1	173.4	68.3
0.1	3.4	1.3	5.2	176.8	69.7
0.2	6.8	2.7	5.3	180.2	71.0
0.3	10.2	4.0	5.4	183.6	72.4
0.4	13.6	5.4	5.5	187.0	73.7
0.5	17.0	6.7	5.6	190.4	75.0
0.6	20.4	8.0	5.7	193.8	76.4
0.7	23.8	9.4	5.8	197.2	77.7
0.8	27.2	10.7	5.9	200.6	79.1
0.9	30.6	12.1	6.0	204.0	80.4
1.0	34.0	13.4	6.1	207.4	81.7
1.1	37.4	14.7	6.2	210.8	83.1
1.2	40.8	16.1	6.3	214.2	84.4
1.3	44.2	17.4	6.4	217.6	85.8
1.4	47.6	18.8	6.5	221.0	87.1
1.5	51.0	20.1	6.6	224.4	88.4
1.6	54.4	21.4	6.7	227.8	89.8
1.7	57.8	22.8	6.8	231.2	91.1
1.8	61.2	24.1	6.9	234.6	92.5
1.9	64.6	25.5	7.0	238.0	93.8
2.0	68.0	26.8	7.1	241.4	95.1
2.1	71.4	28.1	7.2	244.8	96.5
2.2	74.8	29.5	7.3	248.2	97.8
2.3	78.2	30.8	7.4	251.6	99.2
2.4	81.6	32.2	7.5	255.0	100.5
2.5	85.0	33.5	7.6	258.4	101.8
2.6	88.4	34.8	7.7	261.8	103.2
2.7	91.8	36.2	7.8	265.2	104.5
2.8	95.2	37.5	7.9	268.6	105.9
2.9	98.6	38.9	8.0	272.0	107.2
3.0	102.0	40.2	8.1	275.4	108.5
3.1	105.4	41.5	8.2	278.8	109.9
3.2	108.8	42.9	8.3	282.2	111.2
3.3	112.2	44.2	8.4	285.6	112.6
3.4	115.6	45.6	8.5	289.0	113.9
3.5	119.0	46.9	8.6	292.4	115.2
3.6	122.4	48.2	8.7	295.8	116.6
3.7	125.8	49.6	8.8	299.2	117.9
3.8	129.2	50.9	8.9	302.6	119.3
3.9	132.6	52.3	9.0	306.0	120.6
4.0	136.0	53.6	9.1	309.4	121.9
4.1	139.4	54.9	9.2	312.8	123.3
4.2	142.8	56.3	9.3	316.2	124.6
4.3	146.2	57.6	9.4	319.6	126.0
4.4	149.6	59.0	9.5	323.0	127.3
4.5	153.0	60.3	9.6	326.4	128.6
4.6	156.4	61.6	9.7	329.8	130.0
4.7	159.8	63.0	9.8	333.2	131.3
4.8	163.2	64.3	9.9	336.6	132.7
4.9	166.6	65.7			
5.0	170.0	67.0			

Apple CarPlay (Optional)

Apple CarPlay is a smarter, safer way to use your iPhone in the car. Apple CarPlay takes the things you want to do with your iPhone while driving and puts them right on the unit. You can get directions, make calls, send and receive messages, and listen to music, all in a way that allows you to stay focused on the road. Just plug in your iPhone to the unit and go.

- Before using this function, plug in your iPhone using Lightning to USB Cable (Supplied with iPhone) to the unit.
- Some functions may not be available while driving.
- About iPhone models usable with this unit, see "iPod mode on iPhone (Optional)" (page 39). Only an iPhone 5s or later compatible with Apple CarPlay function.
- Before operating Apple CarPlay, set "Apple CarPlay" to [On] (page 19).

Access to Apple CarPlay

1 Touch the (HOME) button.

The HOME screen is displayed.

2 Touch [Apple CarPlay].



[Apple CarPlay] button

The Apple CarPlay screen is displayed.

Touch the desired App icon on the unit, or use Siri function by touching the  button.

- When a used iPhone 5s or later is reconnected, touch the pop-up message- "Apple CarPlay connected." within 5 seconds to access to Apple CarPlay screen, or you can ignore prompt by touching [] on the top right.
- The App must be Apple CarPlay compatible in order to appear in the Home screen.

Android Auto (Optional)

What is Android Auto

Android Auto brings your favorite smartphone apps into one place, making it easier for drivers to access their favorite navigation, media, and communication apps on the road while minimizing the distractions. Talk to Google on Android Auto™ and get things done with your voice so you can keep your eyes on the road and hands on the wheel. Easily send messages, get directions, control media and more. Just say, "Hey Google" or long-press the voice control button on your steering wheel.

Activate Android Auto

Download the Android Auto App from the Google Play store before continuing.

Just plug in your smartphone to the unit's USB connector, then follow the prompt to pair your smartphone with the unit.

- The connected smartphone with Android Auto will disconnect other phone's Bluetooth connection and pair to the unit.

1 Touch the (HOME) button.

The HOME screen is displayed.

2 Touch [Android Auto].



[Android Auto] button

The Android Auto screen is displayed.

- When a used smartphone is reconnected, touch the pop-up message- "Android Auto connected" within 5 seconds to access to Android Auto screen, or you can ignore prompt by touching [] on the top right.
- You can make a call, use voice recognition function and Android Auto's compatible navigation app, etc.
- Only Google approved apps with necessary driver-safety measures in place can be used.

Radio/RDS

There are 3 types of [Radio] widgets for the HOME screen.

■ RDS (FM1/FM2) main screen example

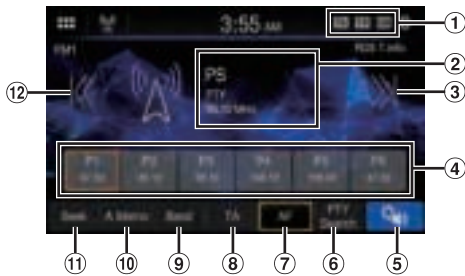

- ① **RDS indicator**
- ② **Information display**
 - For details on switching the display of the Radio text, see "Displaying Radio Text" (page page 32).
- ③ **Increases frequency**

Touch and hold to change the frequency continuously.
- ④ **Preset button**

Displays the preset stations with a short touch.
Touch for at least 1 second to memorize the current station as a preset station.
- ⑤ **Displays the Sound Setup Menu screen (page 22).**
- ⑥ **PTY Search**
- ⑦ **AF mode On/Off**
- ⑧ **Traffic Information mode On/Off**
- ⑨ **Switches a band.**
- ⑩ **Memorizes stations automatically**
- ⑪ **Switches a Seek mode.**
- ⑫ **Decreases frequency**

Touch and hold to change the frequency continuously.







Radio Basic Operation

Listening to the Radio

- 1 Touch the  (HOME) button and select radio mode.**

The display shows the radio mode screen.
- 2 Touch [Band] repeatedly to select the desired band from [FM1] / [FM2] / [AM].**
- 3 Touch [Seek], [Manual], [PTY Seek] or [Preset] repeatedly to select the tuning mode.**

The radio frequency up or down button changes depending on the tuning mode.

Seek mode:	Both strong and weak stations will be tuned in.
Manual mode:	The frequency is manually tuned in steps.
PTY Seek mode: (RDS FM Radio Mode only)	The currently selected program type station will be tuned.
Preset (Preset UP/DN) mode:	The Preset station will be tuned in directly.
- 4 Touch [, , [, , [, ] to change the radio frequency up or down respectively.**

In Manual mode, touch and hold to change the frequency continuously.

Presetting Stations Manually

- 1 Tune in a desired radio station you wish to store in the preset memory by manual or automatic seek tuning.**
- 2 Touch and hold the Preset number you want to store for at least 1 second.**

The selected station is stored.
- 3 Repeat the procedure to store up to 5 other stations onto the same band.**

To use this procedure for other bands, simply select the desired band and repeat the procedure.

A total of 18 stations can be stored in the preset memory
(6 stations for each band; FM1, FM2 or AM).

 - If a preset memory has already been set in the same preset number, it will be cleared and the new station will be memorized.

Presetting Stations Automatically

The tuner can automatically seek and store 6 strong stations in the selected band in ascending order of frequency.

Select the desired band then touch and hold [A.Memo].

The tuner automatically seeks and stores 6 strong stations into the preset buttons in ascending order of frequency. When automatic storing has completed, the station stored in the preset 1 is selected.

- *If no stations are stored, the tuner will return to the original station you were listening to before the automatic storing procedure began.*
- *You can cancel this process by touching [A.Memo] while the tuner is automatically seeking stations. Canceling will return the tuner preset to the previous setting.*

Tuning to Preset Station

After selecting the desired band, touch the desired preset button.

The preset station is received.

RDS Operation

Turning AF (Alternative Frequencies) On or Off

The RDS (Radio Data System) is a radio information system using the 57 kHz subcarrier of regular FM broadcasts. The RDS allows you to receive a variety of information such as traffic information, station names, and to automatically re-tune to a stronger transmitter that is broadcasting the same programme.

Touch [AF] to select the AF (Alternative Frequency) ON or OFF mode.

In AF ON mode, the [AF] button lights up.

- *RDS mode is not displayed for the AM band.*
- *When the AF ON mode is selected, the unit automatically tunes to a strong signal station in the AF list.*
- *Use the AF OFF mode when automatic re-tuning is not required.*

Tips

- *The RDS digital data includes the following:*

PI	Programme Identification
PS	Programme Service Name
AF	List of Alternative Frequencies
TP	Traffic Programme
TA	Traffic Announcement
PTY	Programme Type
EON	Enhanced Other Networks
- *Refer to page 13 about "PI SEEK Setting," "Receiving RDS Regional (Local) Stations," and "Setting PTY31 (Emergency Broadcast) Reception."*

Interruption Function

Interruption Function is enabled, when the following broadcast is received, the unit switches to the Radio source screen automatically, and will receive broadcasts.

- PTY31 (Emergency Broadcast)*1, 2
- TA (Traffic Announcement)*3

*1 Set PTY31 to "On" in "Setting PTY31 (Emergency Broadcast) Reception" (page 13).

*2 Not interrupted during the DAB broadcast reception.

*3 The Interruption Function for Traffic Announcements works with DAB broadcasts. Therefore, even if the current source is RDS, a Traffic Announcement by DAB broadcast may interrupt.

- *"RDS T.Info"/"RDS Alarm" is displayed during each respective broadcast reception.*
- *To cancel the Interruption function, touch [TA], [RDS T.Info] or [RDS Alarm].*
- *If no signal is received for more than 60 seconds, interrupt function exits.*
- *When the interruption broadcast is over, the unit returns to the previous screen.*
- *Does not interrupt during Hands-free phone talk. During camera image display, only the sound may be interrupted.*

- The volume level will be memorized if the volume is adjusted during interruption broadcast reception. When an interruption broadcast is received the next time, the volume level is automatically adjusted to the memorized level.

Receiving Traffic Announcement

Touch [TA].

The "TA" indicator lights up and the unit switches to standby mode for the traffic announcement.

When the traffic announcement is received, the "TP" indicator lights up and the unit switches to the radio source screen to receive it.

- The "TP" indicator lights up during standby mode off in a condition other than radio source to indicate that the unit is receiving the traffic announcement.

Receiving Traffic Information Manually

1 Touch [TA] to turn on the Traffic Information mode.

The TA indicator lights up.

2 Touch [K] or [X].

Seeks the broadcast station which is broadcasting the traffic information.

- You can seek the traffic information in Seek mode.

Selecting the Receivable PTY

You can select and receive the currently receivable stations in the PTY list screen.

1 Touch [PTY Search].

The display shows the Program Type list screen.

2 Select the desired program type in the Program Type list screen.

Program Type Seek starts and the receivable program type is received.

- If no Program Type station is found, "NO PTY" will be displayed.

Displaying Radio Text

Text messages from a radio station can be displayed.

1 Tune in a radio station that transmits text messages.

2 Touch the information display in the FM radio mode repeatedly to switch to the desired display.

Station Info Mode → Song Info Mode → Radio Text Mode → Station Info Mode

Station Info Mode:

PS/PTY/ Frequency/Song Name

Song Info Mode:

PS/Song Name / Artist Name / Album Name

Radio Text Mode:

Radio Text

DAB/DAB+

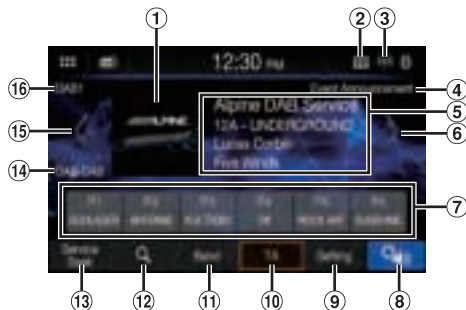

- ① Slide Show
Displays the program information, artist photos, and advertisements that are synchronised with the Service component currently being received. They may not be displayed, depending on the Service component currently being received.
- ② TP indicator
- ③ Signal Strength indicator
- ④ Announcement type indicator
- ⑤ Information display
 - For details on switching the display, see "Displaying DAB Text" (page page 34).
- ⑥ Previous button
Touch to change previous Service/Preset.
- ⑦ Preset button
Displays the preset stations with a short touch. Touch for at least 1 second to memorize the current station as a preset station.
- ⑧ Displays the Sound setting screen (page 22).
- ⑨ Displays the DAB setting screen (page 14).
- ⑩ Traffic Information mode On/Off
- ⑪ Switch the DAB band
- ⑫ Displays select service screen
- ⑬ Changes tuning mode
- ⑭ Linking status indicator
[] : Normal
[DAB-DAB]: DAB-DAB Linking
[DAB-FM]: DAB-FM Linking
 - For details, see "Setting the DAB-DAB Linking ON/OFF (Service Following)" or "Setting the DAB-FM Linking ON/OFF (Service Following)" (page page 14).
- ⑮ Next button
Touch to change next Service/Preset.
- ⑯ Band indicator

Listening to DAB/DAB+

- 1 Touch the  (HOME) button and select DAB mode.**

The display shows the DAB mode screen.

- 2 Touch [Band] repeatedly to select the desired band from [DAB1] / [DAB2] / [DAB3].**

- 3 Touch [Service Seek] or [Preset] repeatedly to select the tuning mode.**

The service up or down button changes depending on the tuning mode.

Service Seek mode: Service Components in the All Service list will be switched.

Preset (Preset UP/DN) mode: The Preset station will be tuned in directly.

- 4 Touch [<<], [>>], [<], [>] to change the Service or Ensemble up or down respectively.**

Touch and hold to change the Service or Ensemble continuously.

Presetting Service

- 1 Select the service and ensemble, and then tune in a desired service you wish to store in the preset memory.**

- 2 Touch and hold the Preset number you want to store for at least 1 second. The selected station is stored.**

- 3 Repeat the procedure to store up to 5 other stations onto the same band.**

To use this procedure for other bands, simply select the desired band and repeat the procedure.

A total of 18 stations can be stored in the preset memory (6 stations for each band; DAB1, DAB2 or DAB3).

- If a preset memory has already been set in the same preset number, it will be cleared and the new service will be memorized.

Tuning to Preset Service

You can tune in the preset stations in memory on either band using its preset number.

Touch any one of the preset buttons that has a service stored to it.

The preset service is received.

Service Component/PTY Search Function

You can select your favorite Service Component from the All Ensemble Service list.

Service Search Function

1 Touch [] (Search).

2 Touch [ALL].

The All Service list in the Full Search mode screen is displayed.

3 Touch the desired Service Component.

The Selected service component is received.

- The PTY is displayed in the Service Component (Primary) list currently being received.

PTY Search Function

1 Touch [] (Search).

2 Touch [PTY].

3 Touch the desired programme type.

The Service Component list that corresponds with the selected programme type is displayed.

4 Touch the desired Service Component.

The selected Service Component is received.

Interruption Function

If Interruption Function is enabled, when the following broadcast is received, the unit switches to the DAB source screen automatically, and will receive broadcasts.

- Alarm (Emergency Announcement)*1, 2
- TA (Traffic Announcement)*2, 3
- NEWS*2,3
- Transport News*2, 3

*1 Set Alarm to "On" in "Setting Emergency Announcement Reception" (page 14).

*2 Not interrupted during the RDS broadcast reception.

*3 Select the Announcement type received in "Setting Announcement Reception" (page 14), then set the Announcement setting to "On."

- "Alarm"/"TA"/"NEWS"/"Transport News" is displayed respectively on the Source title section during each broadcast reception.
- The display differs during announcement reception depending on the announcement type set in "Setting Announcement Reception" (page 14).
- If no signal is received for more than 10 seconds, interrupt function exits.
- To cancel the Interruption function, touch [TA].
- When the interruption broadcast is over, the unit returns to the previous screen.

Receiving Traffic Announcement

Touch [TA].

The "TA" indicator lights up and the unit switches to standby mode for the traffic announcement.

When the traffic announcement is received, the "TP" indicator lights up and the unit switches to the DAB source screen to receive it.

- The "TP" indicator lights up during standby mode off in a condition other than the DAB source to indicate that the unit is receiving the traffic announcement.
- This setting works interlocked with the traffic announcement (Emergency Broadcast) of RDS.

Displaying DAB Text

Text messages from a DAB station can be displayed.

Tune in a DAB station that transmits text messages.

Channel Name / Service Label / Ensemble Label / DLS / DL+ / PTY

About DAB/DAB+

What is DAB?

DAB (Digital Audio Broadcasting) is the third generation broadcasting technology following the traditional analogue technologies such as FM. The advantages of DAB include being more robust with regard to noise, interference, instability, etc., during radio signal transmission. Also, it can provide stereo CD-quality sound and digital information, and it can resist multipath interference guaranteeing high-quality reception for fixed, portable and mobile devices.

What is DAB+?

WorldDAB, the organisation in charge of the DAB standards, announced DAB+, a major upgrade to the DAB standard in 2006, when the HE-AAC v2 audio codec (also known as eAAC+) was adopted. The new standard, which is called DAB+, has also adopted the MPEG Surround audio format and stronger error correction coding in the form of Reed-Solomon coding. DAB+ has been standardised as ETSI TS 102 563.

USB Flash drive (Optional)

You can play back music files (MP3/WMA/AAC/FLAC/WAV), video files (MP4/AVI/WMV/MOV) and photo files (JPG/PNG/BMP) stored in a USB flash drive on the internal player of this system.

⚠ WARNING

It is dangerous for the driver to watch video while driving the vehicle. The driver may be distracted from looking ahead and an accident could occur.

Install the unit correctly so that the driver cannot watch a video unless the car is stopped and the parking brake is applied.

If the unit is not installed correctly, the driver will be able to watch a video while driving and may be distracted from looking ahead and cause an accident. The driver or other people could be severely injured.

USB Audio

■ USB Audio mode screen



- ① Artwork display
- ② Information display
- ③ Finds the beginning of next chapter/Fast-forwards when touched for at least 1 second
- ④ Shuffle mode
- ⑤ Repeat mode
- ⑥ Displays the Sound Setup Menu screen (page 22)
- ⑦ Switches to iPod mode of iPhone or Bluetooth Audio.
- ⑧ Displays the search screen
- ⑨ Pause and Play
- ⑩ Elapsed time/Total time for playing
- ⑪ Current track number/Total track number
- ⑫ Finds the beginning of the current file/Finds a previous file within one second after playback starts/Fast-reverses when touched for at least 1 second

Playback

1 Touch the (HOME) button and select USB Audio mode.

The display shows the USB Audio mode screen.

2 Touch [] or [] to select the desired track (file).

Returning to the beginning of the current (or previous) track (file):

Touch [].

Fast reverse :

Touch and hold [].

Advancing to the beginning of the next track (file) :

Touch [].

Fast forward :

Touch and hold [].

3 To pause playback, touch [].

Touching [] again will resume playback.

- The playback time may not be correctly displayed when a VBR (Variable Bit Rate) recorded file is played back.
- If there is tag information, artist name/album name/track name is displayed.
- ID3 tag/WMA tag
If an MP3/WMA/AAC/FLAC/WAV file contains ID3 tag/WMA tag information, the ID3 tag/WMA tag information is displayed. (e.g., song name, artist name, and album name)
- When selecting a [Audio] widget on the HOME screen, touch [Audio Select] to select [USB]. If [USB] is already selected, you can start playback by selecting a [Audio] widget on the HOME screen.

Repeat Play

Touch [], [] or [] to select Repeat Play mode.



ALL : All files are repeatedly played back.

File : Only the file currently playing is repeatedly played back.

Folder : Only files in a folder are repeatedly played back.

Shuffle Play

Touch [] to select Shuffle Play mode.

- Folder** : A Folder is selected randomly and songs in the Folder are played back in order. After all songs are played in a Folder, the next Folder is selected randomly.
- Song** : All songs in the Folder (Folder/File) including the song currently being played are played back in random sequence.
- OFF** : Shuffle mode is Off.

- If you select a track by using the search mode, the Shuffle mode will be canceled.

Searching for a Desired Song

1 Touch [] (Search).

2 Touch your desired Folder name or File name.

- When you select a Folder name, repeat the same procedure to select another Folder name or File name.
- Touch [**Shuffle Songs**] to randomly play back all songs in the USB flash drive.

USB Video

The video formats (USB Flash drive) supported by the unit are as follows.

- Supported Container: AVI/MP4/WMV/MOV/MPG
- Supported Video Coding: H.264/MPEG-4 AVC
- Supported Audio Coding: MP3, AAC, MPEG2 audio
- MAX File Size: 4GB

■ USB Video mode screen

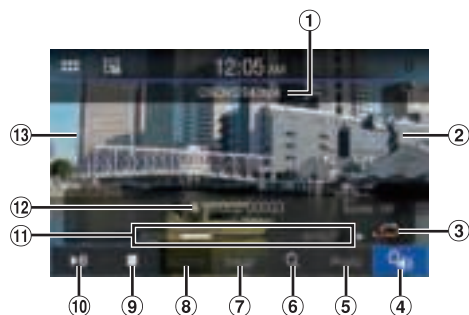

- ① File Name
- ② Finds the beginning of next file/Fast-forwards when touched for at least 1 second
- ③ Shuffle mode
- ④ Displays the Sound Setup Menu screen (page 22)
- ⑤ Switches to USB Photo mode
- ⑥ Displays the search screen
- ⑦ Sets the Brightness and Contrast
- ⑧ Displays the Subtitle
- ⑨ Stop
- ⑩ Pause and Play
- ⑪ Elapsed time/Total time for playing
- ⑫ Current file number/Total file number
- ⑬ Finds the beginning of the current file/Finds a previous file within one second after playback starts/Fast-reverses when touched for at least 1 second

Touch the (HOME) button and select USB Video mode.

The display shows the USB Video mode screen.

- To select USB Video mode, touch the [USB Video] or [Video] widget on the HOME screen.

During the USB Video playback, touch the screen to display the operation screen.

- For the basic operations on USB Video mode, refer to "Playback" (page 35).
- The operation screen changes to the visual screen in the USB Video mode for 5 seconds after an operation has been performed.
- For your safety, video is not displayed and only audio can be heard while driving.

Fast-forwarding/Fast-reversing

1 During playback, touch and hold [⏮] (Fast-reverse) or touch and hold [⏭] (Fast-forward).

Touch and hold for more than 1 second to forward/reverse by a 10 seconds interval.

2 Release [⏮] or [⏭] to return to normal playback.

- No sound is played back during fast-forwarding/fast-reversing.

Stopping Playback



Touch [■] during playback.

“STOP” indicator is displayed, and playback stops.

- Playback starts from the beginning when [▶] is touched while playback is stopped.

Repeat Play

Touch [ALL], [File] or [Folder] to select Repeat Play mode.

- ALL : All files are repeatedly played back.
- File : Only the file currently playing is repeatedly played back.
- Folder : Only files in a folder are repeatedly played back.

Searching for a Desired file

1 Touch [🔍] (Search).

2 Touch your desired Folder name or File name.

- When you select a Folder name, repeat the same procedure to select another Folder name or File name.
- Touch [Repeat videos] to repeatedly play back all videos in the USB flash drive.

Setting the Brightness and Contrast

1 Touch [Visual].

2 Touch [+] or [-] to adjust the Brightness and Contrast.

: Adjusting the Brightness

: Adjusting the Contrast

Displaying the Subtitle

Depending on the video file such as “.smi” or “.srt”, you can display the subtitle contained on the file.

Touch [Subtitle].

To cancel displaying the subtitle, touch [Subtitle] again.

- If the file is not supported or the subtitle is not contained on the file, [Subtitle] is not available.

USB Photo

■ USB Photo mode Preview screen



■ USB Photo mode screen

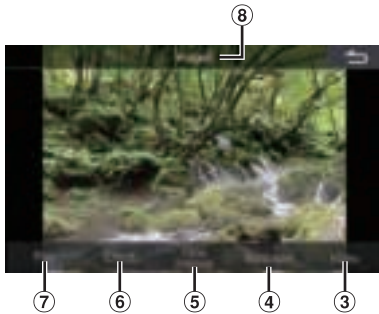

- ① Photo Preview
- ② Photo files List
- ③ Switches to USB Video mode
- ④ Sets the photo as a wallpaper (page 15)
- ⑤ Sets the Time Interval for the Slide Show
- ⑥ Applies an Effect to the photo
- ⑦ Plays the Slide Show
- ⑧ File Name

During the USB Photo playback, touch the screen to display the operation screen.

- The operation screen changes to the visual screen in the USB Photo mode for 5 seconds after an operation has been performed.

2 Select the desired photo from the photo files list.

- To select the other photo (file), touch [↩] to return to the previous screen.

Slide Show

The Slide Show shows photos that change every 3 seconds.

Touch [Play].

- To stop the Slide Show, touch the screen.

Setting the Effect for Playback

You can set the playback effect how switches to the photo for Slide Show.

Touch [Effect], and then select the desired effect.

Setting the Time Interval for Slide Show

You can set the time interval to switch to the next photo.

Touch [Time Interval], and then select the desired time interval.

Setting a Wallpaper with a Photo

To set a wallpaper with your favorite photo, refer to "Setting a Wallpaper using your image" (page 15).

Playback

1 Touch the (HOME) button and select USB Photo mode.

The display shows the USB Photo mode screen.

- To select USB Photo mode, touch the [Photo] or [Photo Frame] widget on the HOME screen.

iPod mode on iPhone (Optional)

A separately sold Lightning to USB cable (KCU-471i), etc., is required.

- This unit does not support video playback from iPhone which connected to this unit via USB Connector.
- Internet or telephone function, etc., of the iPhone is not controllable from the unit, but these functions can be controlled using the iPhone itself.
- Before operating iPod mode on iPhone, set "Apple CarPlay" to [Off] (page 19).

■ iPod main screen example



- 1 Artwork display
- 2 Information display*
- 3 Finds the beginning of the current file/Finds a previous file within one second after playback starts/Fast-reverses when touched for at least 1 second
- 4 Shuffle mode
- 5 Repeat mode
- 6 Displays the Sound Setup Menu screen (page 22).
- 7 Switches to the USB Flash drive or Bluetooth Audio.
- 8 Displays the search screen
- 9 Pause and Play
- 10 Elapsed time/Total time for playing
- 11 Current song no./Total song no.
- 12 Finds the beginning of the current file/Finds a previous file within one second after playback starts/Fast-reverses when touched for at least 1 second

* Podcast mode.

Playback

1 Touch the (HOME) button and select iPod mode.

The display shows the iPod mode screen.

2 Touch [] or [] or to select the desired track (file).

Returning to the beginning of the current (or previous) track (file):

Touch [].

Fast reverse the current track :

Touch and hold [].

Advancing to the beginning of the next track (file) :

Touch [].

Fast forward the current track :

Touch and hold [].

3 To pause playback, touch [].

- If a song is playing on the iPhone before it is connected to the unit, it will continue playing when it is connected.
- An episode may have several chapters. The chapter can be changed by touching [] or [].
- If the artist, album or song name, created in iTunes, has too many characters, songs may not be played back when connected to the unit. Therefore, a maximum of 64 characters is recommended. The maximum number of characters for the unit is 64.
- Some characters may not be correctly displayed.
- When selecting a [Audio] widget on the HOME screen, touch [Audio Select] to select [iPod]. If [iPod] is already selected, you can start playback by selecting a [Audio] widget on the HOME screen.

Searching for a Music File

An iPhone can contain thousands of songs. For this reason, this unit can make various searches using the search function as shown below.

Using the Playlist/Artist/Album/Podcast/Audiobook/Genre/Composer/Song/Radio search mode's individual hierarchy, you can narrow down your search as shown in the table below.

<Music Search Menu>

Hierarchy 1	Hierarchy 2	Hierarchy 3	Hierarchy 4
Playlists	Songs	—	—
Artists	Albums	Songs	—
Albums	Songs	—	—
Songs	—	—	—
Genres	Artists	Albums	Songs
Composers	Albums	Songs	—
Podcasts	Episodes	—	—
Audiobooks	—	—	—
Radio	—	—	—

For example: Searching by Artist name

The following example explains how an Artists search is performed.

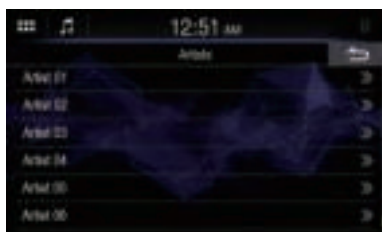

1 Touch [Q] (Search) during playback.

2 Touch [Artists].

The Artists search screen is displayed.

3 Touch the desired artist's name.

4 Touch the desired album's name.

All songs of the selected album are displayed.

5 Touch the desired song's name.

The selected song is played back.

Repeat Play

Touch [↺] to select Repeat Play mode.

ALL : All files are repeatedly played back.

File : Only the file currently playing is repeatedly played back.

OFF : Repeat mode is Off.

Shuffle Play

Touch [✂] to select Shuffle Play mode.

Songs : Song shuffle randomly plays back songs within a selected category (playlist, album, etc.). The songs within the category are played just once until all songs have been played.

OFF : Shuffle mode is Off.

HDMI Device (Optional)

Devices supporting HDMI can connect and play back through this unit (for example, an optional DVD Player, iPhone or other Smartphones).

- *The HDMI/MHL connecting cable differs depending on the connected device corresponding to HDMI. Prepare optional HDMI/MHL connecting cable sets suitable for your device.*

HDMI Operation

■ iPhone, Smartphone, etc.

The output of your electronic device will be mirrored on this unit through the HDMI connector. Control from this unit is not possible.

- *The electronic device must possess an HDMI output interface.*
- *Not all devices with an HDMI output interface can be recognised by this unit.*
- *Use only the Alpine Special HDMI connection cable.*

1 Touch the (HOME) button to select HDMI.

The display shows the HDMI mode screen.

- *You can select and change the source in the HOME screen (page 11).*
- *For your safety, video is not displayed and only audio can be heard while driving.*

2 In HDMI player mode, the screen of the device displays the content of electronic equipment by mirror image.

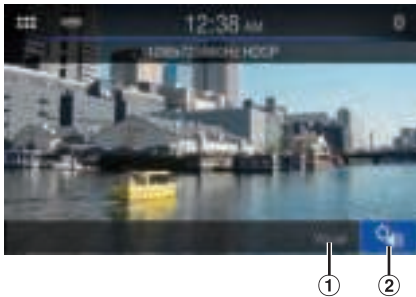



- ① Sets the Brightness and Contrast
- ② Displays the Sound Setup Menu screen (page 22).

Setting the Brightness and Contrast

1 Touch [Visual].

2 Touch [+] or [-] to adjust the Brightness and Contrast.

 : Adjusting the Brightness

 : Adjusting the Contrast

Bluetooth Operation

Setup Before Using

About Bluetooth

Bluetooth is a wireless technology allowing communication between a mobile device or personal computer over short distances. This enables a hands-free call or data transmission between Bluetooth compatible devices. Bluetooth transmission is available in the unlicensed 2.4 GHz spectrum if the distance between devices is within 10 meters. For details, refer to the Bluetooth website (<http://www.bluetooth.com/>).

- Depending on the Bluetooth version, a Bluetooth compatible device may not be able to communicate with this unit.
- Proper function of this unit with all Bluetooth compatible devices is not guaranteed. For handling of the Bluetooth compatible device, consult your Alpine dealer or Alpine website.
- Depending on the surroundings, Bluetooth wireless connection may be unstable.
- When you place a call, or perform setup operations, be sure to stop your car in a safe place.
- Depending on the connected Bluetooth compatible device(s), the function may differ. Also refer to the Owner's Manual of the connected device(s).

About the Hands-free Phone

Hands-free calls are possible when using a HFP (Hands-Free Profile) compatible mobile phone with this unit.

- Avoid performing a hands-free call in heavy traffic or on narrow or winding streets.
- Close the windows while calling to reduce background noise.
- If both calling parties are using hands-free devices, or the call is made in a noisy location, difficulty hearing the other person's voice is normal.
- Depending on telephone line conditions or certain mobile devices used, voices may sound unnatural.
- When using a microphone, speak as directly as you can into the microphone to obtain the best sound quality.
- Certain mobile phone features are dependent on the capabilities and settings of your service provider's network. Additionally, certain features may not be activated by your service provider, and/or the provider's network settings may limit the feature's functionality. Always contact your service provider about feature availability and functionality.
- All features, functionality, and other product specifications, as well as the information contained in the Owner's Manual are based upon the latest available information and are believed to be accurate at the time of printing. Alpine reserves the right to change or modify any information or specifications without notice or obligation.
- Notice that when you connect an iPhone 5s or later/Android smartphone which installed Android Auto App, the operation screen may differ from this section.

Before Using Bluetooth

Before using the hands-free phone/audio function, the following settings need to be made.

Register a Bluetooth device in this unit.

- See "Connection (Bluetooth) Setup" (page 18).
- You can search for this unit using a Bluetooth compatible device, and then connect that Bluetooth compatible device to this unit. The device name of this unit is "iLX-W690D" and the initial number of the passcode is "0000." Also refer to the Owner's Manual of the connected device(s).

Hands-free Phone Control

Touch the Phone button to display the Phone menu screen.



Phone button

- You can also display the Phone menu screen by selecting the [Phone] widget on the HOME screen.

■ Phone menu screen example

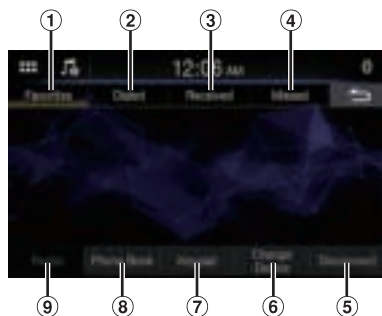

- ① Favorite
Displays a list of numbers set as your favorite.
- ② Dialed
Displays a list of dialed calls.
- ③ Received
Displays a list of the received calls.
- ④ Missed
Displays a list of the missed calls.

- ⑤ **Disconnect**
Disconnects the Bluetooth device. After disconnecting, the display changes to **[Reconnect]** to connect the disconnected device again.
- ⑥ **Change Device**
Displays the Bluetooth Setup screen.
- ⑦ **Keypad**
Use to type a phone number.
- ⑧ **Phone Book***
You can make a phone call from the Phone Book, or edit the Phone Book.
- ⑨ **Redial**
Dials to the last called number.

* If the Hands-Free Phone is not connected, the Bluetooth Setup screen will be displayed. See "Connection (Bluetooth) Setup" (page 18).

Answering a Call

- 1 An incoming call triggers the ringtone and an incoming call display.**

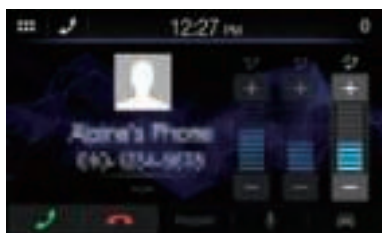

- You can adjust the ringtone volume by touching [+] or [-] of "Ringtone Volume (🔊)".

- 2 Touch [📞].**

The call starts.

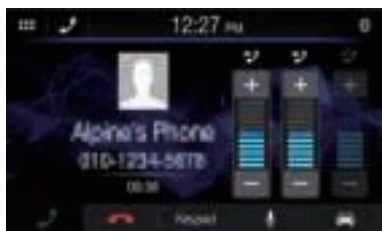

- During a call, the audio for the current mode on the unit is muted. After calling, playback will resume.
- When the caller's number is transmitted to the system, if the caller's name is stored in the phone book, the name is displayed. If the name is not stored, the number is displayed.
- Touch [📞] (Decline) to reject an incoming call.
- By touching [📞], you can mute the microphone. To cancel MUTE mode, touch [🔇]. For details, see "Phone Operation Screen" (page 45).
- If another call comes during a call, operate on the Bluetooth Device.

Hanging up the Telephone

- 1 Touch [📞] (End Call).**

The call finishes.

Calling

Making a phone call using the Phone Menu

Making a phone call from the Recent Events list

- 1 Select a category from [Favorite], [Dialed], [Received] or [Missed] on the Phone menu.**

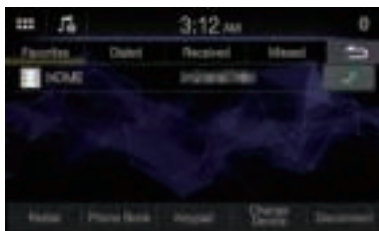

- 2 Touch [📞] of the name or number of the contact which you want to call.**

- 3 Touch [Call].**

The phone call is started.

- To use [Favorite], see "Setting contacts as Favorites (Shortcut Dialing)" (page 46).

Calling from the Phone Book

- 1 Touch [Phone Book] on the Phone menu.**

The Phone Book screen appears.



- 2 Touch [📞] of the name or number of the contact which you want to call.**

The phone call is started.

Entering a Phone Number to Make a Call

1 Touch [Keypad] on the Phone menu.

The number input screen (Keypad) appears.

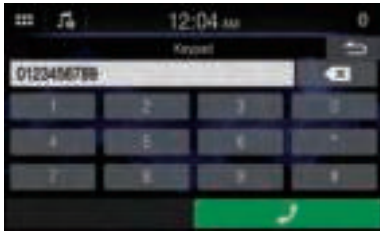

Touch [X] to delete an entered number.

2 Enter the phone number you wish to call.

- You can enter up to 21 digits.

3 Touch [Call].

A confirmation message of the phone number appears.

4 Touch [Call].

The phone call is started.

Calling in Private

When using the Private Call setting, the conversation is not output through the speaker.

Touch [] during the call.

- To change the Bluetooth device, touch [Change Device] to display the Bluetooth Setup screen. See “Connection (Bluetooth) Setup” (page 18).

Using Voice Recognition function

You can use Siri function of your iPhone or make a telephone call by using voice operation of your smartphone.

- When using Apple CarPlay or Android Auto, the operation screen may differ from the screen design in the Owner's Manual.

Using Siri

You can use the Siri function of your iPhone. To use this function, set the Siri setting of your iPhone to ON.

- Connect your iPhone to the unit via Bluetooth, then set to “Hands-free” (page 18).
- The available functions differ depending on the connected iPhone.
- Ask Siri to play a track from the music library applies only to USB source.
- Siri and other streaming services are enabled by connecting to compatible smartphones that are able to receive data. Please ensure that cellular data and/or Wi-Fi is turned on in the smartphone to enjoy these features.

- Extensive use of Siri or other streaming services may increase your phone's data usage. Please check with your phone company to ensure you have an appropriate Data plan.

1 Touch [Voice Recognition] button.

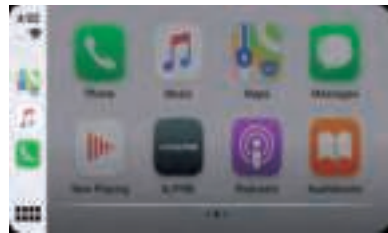

The Voice Recognition mode screen is displayed.

2 Speak into the microphone supplied with this unit.

3 To finish the Voice Control mode, touch [Cancel].

- Depending on the iPhone, the Siri function may finish automatically.
- For adjusting the volume, see “Adjusting the Speech Volume” (page 45).

Voice Dial Function

You can make a telephone call by using voice operation.

- Connect your smartphone to the unit via Bluetooth, then set to “Hands-free” (page 18).

1 Touch [Voice Recognition] button.

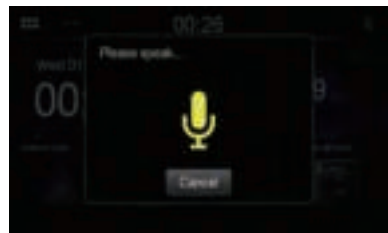

The Voice Dial mode screen is activated.

2 Say the telephone number* or name* you want to call, into the microphone.

- * The number and name depend on the voice dial information stored in the smartphone.

3 To finish the Voice Dial mode, touch [Cancel].

- You can perform this operation only when a voice dial compatible smartphone is connected.
- The Voice Dial function performance depends on the recognition range of the smartphone and mounting location of the microphone.
Note when the microphone is mounted.

- Voice dial operation depends on the function being available on the smartphone. For details, refer to the owner's manual of the smartphone.
- Depending on the smartphone, the Voice Dial operation may finish automatically.
- For adjusting the volume, see "Adjusting the Speech Volume" (page 45).

Phone Operation Screen



- 1 Name and phone number
 - If it is registered with a Group, the Group Name is also displayed. Although, depending on the connected mobile phone, it may not be displayed.
- 2 Conversation time

Adjusting the Speech Volume

You can adjust Caller Level and Microphone Level.

Touch [-] or [+] of "Speaker Volume (🔊)" or "Mic Level (🔊)".

You can adjust the volume in 11 levels.

Changing the Voice Output

The voice output for calls is switchable between car speakers and the mobile phone speaker.

Touch [📱] or [🚗].

- Depending on the mobile phone, this operation may not be possible.

Muting the Microphone

Touch [🚫].

- To cancel MUTE mode, touch [🚫].

DTMF (Touch-Tone) Function

Transmits a DTMF (Touch-Tone) during a call.

1 Touch [Keypad].

The number input screen (Keypad) appears.

2 Input number.

- You can transmit a Touch-Tone signal during a call.

Phone Book Function

Phone Book screen example



Searching in the Phone Book

You can make a call using the phone book search function.

1 Touch [Search] on the Phone Book screen.

The Input User Name screen (Keypad) is displayed.

2 Input the string of letters of the name that you want to search, then touch [OK].

A list of names beginning with the string of letters you entered is displayed.

3 Touch [📞] of the name or number of the contact which you want to call.

The phone call is started.

- If there are fewer than five registered items in the phone book, you cannot use the phone book search function.

Synchronizing the Phone Book

You can synchronize the system's phone book with the mobile phone's phone book.

1 Touch [SYNC] on the Phone Book screen.

The confirmation screen is displayed.

2 Touch [Yes].

Synchronization of the phone books starts.

- You can store up to 1,000 registered name in the phone book.
- You can store up to 5 phone numbers by one person's name.

Deleting the Phone Book Entries

Deleting One Entry from the Phone Book

Touch [] of the contact name (or phone number) you want to delete.

The selected number is deleted.

Deleting All Entries from the Phone Book

1 Touch [Delete All] on the Phone Book screen.

The confirmation screen is displayed.

2 Touch [Yes].

All entries of the phone book are deleted.

Setting contacts as Favorites (Shortcut Dialing)



You can set contacts from the Phone Book, Dialed, Received, and Missed list as favorites.

1 Touch the name or phone number on the list.

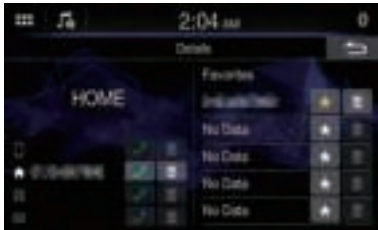
2 Touch [] of "Favorites."



The phone number is set as a Favorite.

- Up to 5 contacts can be set as Favorites.
- If [] has already been set with a number, touching it overwrites the number.
- To delete a contact from the Favorites list, touch [].

Bluetooth Audio

If a Bluetooth compatible mobile phone, portable player, etc. is connected by wireless, you can play back a song (operation is controllable from the unit).

- Operation may vary, depending on the Bluetooth compatible device.

■ Bluetooth Audio main screen example



- ① Information display
- ② Finds the beginning of next chapter/Fast-forwards when touched for at least 1 second
- ③ Shuffle mode
- ④ Repeat mode
- ⑤ Displays the Sound Setup Menu screen (page 22).
- ⑥ Switches to the USB Flash drive or iPod mode of iPhone.
- ⑦ Disconnects the Bluetooth device
- ⑧ Changes the Bluetooth device.
- ⑨ Pause and Play
- ⑩ Elapsed time/Total time for playing
- ⑪ Current track number/Total track number
- ⑫ Finds the beginning of the current file/Finds a previous file within one second after playback starts/Fast-reverses when touched for at least 1 second

- The displayed onscreen buttons may differ depending on the AVRCP version.
- Song title/Artist title/Album title/Elapsed time do not display for AVRCP Ver. 1.0.
- To play back audio, a mobile phone or a portable player conforming to A2DP (Advanced Audio Distribution Profile) or AVRCP (Audio/Video Remote Control Profile) is required. Not all functions work with all devices.
- During a call, sound on the Bluetooth audio source is paused.

Compatible AVRCP versions: 1.0, 1.3, 1.4, 1.5

- Available functions may differ depending on the AVRCP version.

Playback

1 Touch the (HOME) button and select Bluetooth Audio mode.

The display shows the Bluetooth Audio mode screen.

2 Touch [] or [] to select the desired track (file).

Returning to the beginning of the current file:

Touch [].

Fast backward the current file:

Touch and hold [].

Advance to the beginning of the next file:

Touch [].

Fast forward the current file:

Touch and hold [].



3 To pause playback, touch [].

- When selecting a [Audio] widget on the HOME screen, touch [Audio Select] to select [BT]. If [BT] is already selected, you can start playback by selecting a [Audio] widget on the HOME screen.

Repeat Play

Available for AVRCP Ver. 1.4 and 1.5 only.

Touch [] repeatedly to select Repeat Play mode.



- File : Only the track currently playing is repeatedly played back.
- ALL : Once all of the songs have finished playing, play back is repeated, starting with the first song.
- Off : Repeat mode is Off.

- Operations may differ depending on the connected Bluetooth compatible device.

Shuffle Play

Available for AVRCP Ver. 1.4 and 1.5 only.

Touch [] to select Shuffle Play mode.

- ALL : All songs in the Bluetooth compatible devices are played back in random sequence. Any one song does not play back again until all songs have been played back.
- Off : Shuffle mode is Off.

- Operations may differ depending on the connected Bluetooth compatible device.

Connecting a Bluetooth Device

Registering a Bluetooth device in the unit enables automatic connection.

If it does not connect automatically, run through the connection procedure again.

Touch [Reconnect] on the Bluetooth Audio screen.

The Bluetooth connection will start.

Disconnecting the Bluetooth Connection

Touch [Disconnect] on the Bluetooth Audio screen.

The Bluetooth connection is disconnected.

Switching the connecting Bluetooth Device

If multiple Bluetooth devices are registered in this device, you can change the connection among the registered devices.

1 Touch [Change Device] on the Bluetooth Audio screen.

2 Touch the device name.

The connection will transfer to the selected device.

Auxiliary Device (Optional)

Operating Auxiliary Devices (Optional)

To operate devices connected to the AUX terminals of the unit, follow the procedure described below.

- Set up the "AUX Setup" (page 15).

WARNING

It is dangerous (and illegal in many states) for the driver to watch video while driving the vehicle. The driver may be distracted from looking ahead and an accident could occur.

Install the unit correctly so that the driver cannot watch video unless the car is stopped and the parking brake is applied.

If the unit is not installed correctly, the driver will be able to watch video while driving and may be distracted from looking ahead and cause an accident. The driver or other people could be severely injured.

1 Touch the (HOME) button to select Auxiliary (AUX) mode.

The display shows the Auxiliary (AUX) mode screen.





- For your safety, video is not displayed and only audio can be heard while driving.
- For details on the connected auxiliary device, refer to its owner's manual.

Setting the Brightness and Contrast

1 Touch [Visual].

2 Touch [+] or [-] to adjust the Brightness and Contrast.

 : Adjusting the Brightness

 : Adjusting the Contrast

Camera Operation (Optional)

When an optional camera is connected, the view video of camera can be output to the monitor.

Rear camera:

If a rear camera is connected, when the vehicle is reversed, the rear camera view (guide marks for vehicle width and available distance) is displayed automatically on the screen of this unit.

Front camera:

If a front camera is connected, it can assist to check the condition in front of the car, such as when the road visibility is bad.

You can adjust the quality of the camera image.
Setting items: Brightness / Color / Contrast
See "Camera Picture Quality Setup" (page 21).

Rear Camera Operation

Displaying the Camera Image from the HOME screen

1 Touch the (HOME) button.

The HOME screen is displayed.



[Camera[Rear]] button

- If [Camera Select] in the Rear Camera setting is set to [Off] (page 20), the [Camera[Rear]] button cannot be selected.

2 Touch [Camera[Rear]].

The Rear Camera view image is displayed.

- Touch [] to return to the main source screen or previous screen.
- You can perform a Guide Adjustment for the rear view image. For details, see "About the Rear Camera Guide" (page 49).

Displaying the rear view video while the car is in reverse

1 Shift the gear lever to the reverse (R) position.

The rear view image is displayed while the car remains in reverse.

2 If you shift the gear lever to a position other than reverse (R), the monitor returns to the previous screen.

- Never depend solely on the camera when backing up. Always turn and look and only use the camera for additional assistance.
- This function is effective when the reverse wire is properly connected.
- Touch [] to return to the main source screen or previous screen.
- You can perform a Guide Adjustment for the rear view image. For details, see "About the Rear Camera Guide" (page 49).

About the Rear Camera Guide

To display the guide, set "Turning the Rear Camera Guide On/Off" (page 20) to On. Also, to adjust the guide, see "Rear Camera Guide Settings" (page 20).

■ Indication mark meaning

When the car is put into reverse gear, the monitor switches to the rear view camera image. Guides appear to help visualize the car's width and distance from the rear bumper.

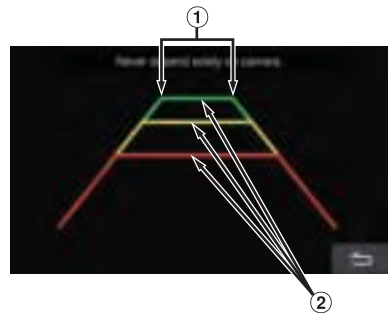

① Car width extension lines (red, yellow and green in order of distance)

If properly calibrated, the marks indicate the car's width. This helps guide the car's path when backing up in a straight line.

The marks represent the distance from the rear of the car (from the rear end of the bumper).

- The marks do not move in synchronization with the steering wheel.
- Set the marks to suit the car's width.

② Distance guidance lines

The marks represent the distance from the rear of the car (from the rear end of the bumper).

- The marks do not move in synchronization with the steering wheel.
- We recommend that you measure the actual distance to the marks when parked on a level surface.
- Depending on the condition of the car or road surface, the range of vision may vary.
- The camera has a limited range of vision. Objects at extreme angles to the camera (e.g. under the bumper or at opposite ends of the bumper) may not be in its field-of-vision.
- The rear camera image may have a tint which is different from the actual surroundings.
- Depending on the car, the guidance may deviate to the right or left. This is not a malfunction.

■ Distance guidance mark

The distance guides represent the ground level distance from the rear bumper. It is difficult to accurately estimate the distance to objects above ground level.

In the following example, the distance to A is 0.5 m and the distance to B is 1 m.

<Screen>



<Positions of A, B and C>

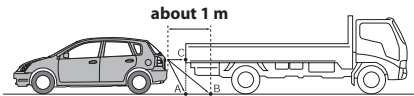

In the screen, according to the distance guidance marks, the truck seems to be parked about 1 m away (at the position B). In actual fact, however, if you reversed to position A, you would collide with the truck.

In the screen, positions A, B and C seem to be located in order of proximity. However, in actual fact, the position A and C are the same distance, and B is farther away than positions A and C.

- The car width extension mark represents the distance to the road surface. The distance to an object on the road is not accurately represented by the guides.

Error between the screen and the actual road surface

In the following conditions, errors are produced between the screen guidance and the actual road surface. (The illustrations represent a case when the camera is installed in the standard position.)

■ When there is a steep upward slope behind the car (example)

<Screen>

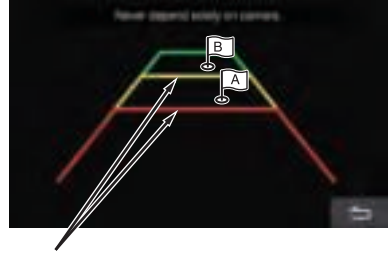

Distance guidance marks

<Situation of the car>

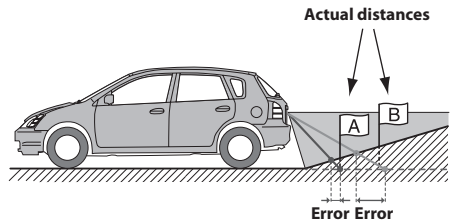

The distance guidance mark represents the distance to a flat road surface. Therefore in the case of an upward slope behind the car, the distance guides are displayed closer to the rear bumper than the actual distance. For example, if there is an obstacle on the upward slope, it may appear farther away than its actual position.

Also, an error may occur between the guidance and the actual path of the car on the road surface.

■ When there is a steep downward slope behind the car (example)
the car (example)

<Screen>

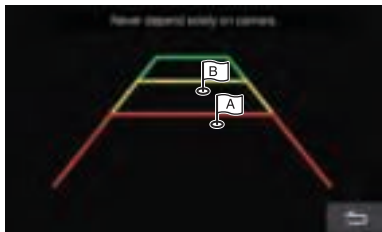

<Situation of the car>

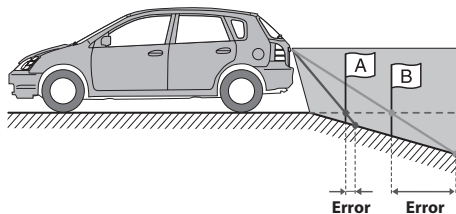

In the case of a downward slope behind the car, the distance guides are displayed farther from the rear bumper than the actual distance.

If there is an obstacle on the downward slope, it seems closer than its actual position.

Also, an error may occur between the guidance and the actual path of the car on the road surface.

Front Camera Operation

Displaying the Camera Image from the HOME screen

1 Touch the (HOME) button.

The HOME screen is displayed.



[Camera[Front]] button

- If [Camera Select] in the Front Camera setting is set to [Off] (page 21), the [Camera[Front]] button cannot be selected.

2 Touch [Camera[Front]].

The Front Camera view image is displayed.

- Touch [] to return to the main source screen or previous screen.

About Vehicle Interlock Function

Communication between your vehicle and the unit allows you to set and display various functions of your vehicle.*¹ Available functions differ depending on your vehicle. For details, refer to your vehicle's instruction manual.

- An CAN Interface Box (sold separately) is required.
- Available functions differ depending on your vehicle. For details, refer to your vehicle's instruction manual.

Available Main Functions

Audio Interrupt is the function that outputs sound from the unit when Voice Information (audio reading from the phone book, etc.)* from the vehicle occurs.

- You can check the air conditioner settings on the Climate screen.*²
- You can check for obstacles on the Parking Sensor screen.*²
- You can adjust various settings for your vehicle from the unit.

*1 Prerequisite is a compatible CAN-Interface, e.g. from the APF-X3xxx series.

*2 When the Interruption function is set to "On," the screen changes automatically when you adjust the air conditioner or the unit detects an obstacle. For details on the Interruption setup, see "CAN I/F BOX Setting" (page 18).

Access to Vehicle Info Mode

You can check the car's status, set the air conditioning, etc.

1 Touch the (HOME) button to select Vehicle info mode.

- The Vehicle Info mode screen selected in "Setting the Default Vehicle Screen" (page 18) is displayed.

2 Touch the desired tag on the top of the screen.

Select item:

Climate / Park Sensor / Car Setting

- The displayed tag options differ depending on the type of vehicle.

3 Adjust or confirm the item/information accordingly.

- Operable functions and displays may differ depending on the vehicle.

Function Screen example

■ Climate screen example

You can control the temperature inside the vehicle, etc.

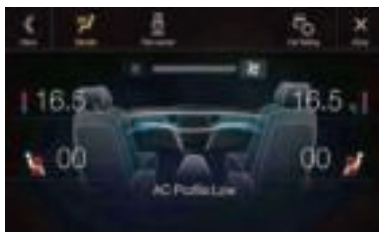

■ Parking sensor screen example

You can check the distance from the front and rear of the vehicle to an obstacle.



- If the car sensor detects an obstacle, the screen automatically changes to the Parking sensor screen. For details, see "About Parking Sensor screen" (page 53).

■ Car Setting screen example (Generic List screen)

The Generic List/Popup Window/Current source control screen is displayed.

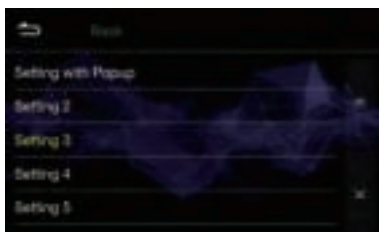

About Parking Sensor screen

The Parking sensor screen turns on when the front or rear sensor on your vehicle detects an obstacle within a certain distance.

Parking Sensor Full screen example

When the front or rear sensor detects an obstacle within a certain distance, the Parking Sensor screen is displayed, and the indicator that corresponds with that area lights up.



Indicator colors when an obstacle is detected.

Red: close distance
Orange: medium distance
Yellow: long distance

- Depending on the speed of the vehicle, when moving faster than a certain speed, the Parking Sensor screen may not be displayed.
- Vehicles that do not have the obstacle detection sensor cannot use this function.

Parking Sensor Camera interlock screen example **(Rear camera)**

You can check for obstacles through an interlocked camera image by connecting a Rear Camera or Front Camera.



- Touch the Camera image area to switch to the Camera full screen.
(While displaying the Camera full screen, touch the Camera screen, then touch [↔] to return to the Parking Sensor Camera interlock screen.)
- Touch the car icon to switch to the Parking sensor full screen.
(Touch [↔] on the Parking Sensor full screen to return to the Parking Sensor Camera interlock display.)
- To use this function, set the Camera Select setting of the Rear Camera and Front Camera, to "Rear" or "Front". For details, see "Camera Input Setting" (page 20 or page 21).

Information

Product Software Update

This product use software that can be updated through a USB flash drive. Download the software from the Alpine website and update the product using the USB flash drive.

Updating this product

Check the Alpine website for details on updating.
<https://www.alpine-europe.com/alpine-europe.html>

Important information on the software

About the software license of the product

The software installed in the product contains open-source software.

For details, refer to the "Open source licenses" screen on this unit. See "Displaying Warranty/Copyright Information" (page 17).

About the Supported Formats

About MP3/WMA/AAC/FLAC/WAV

CAUTION

Except for private use, duplicating audio data (including MP3/WMA/AAC/FLAC/WAV data) or distributing, transferring, or copying it, whether for free or for a fee, without permission of the copyright holder is strictly prohibited by the Copyright Act and by international treaty.

What is MP3?

MP3, whose official name is "MPEG Audio Layer 3," is a compression standard prescribed by the ISO, the International Standardization Organization and MPEG which is a joint activity institution of the IEC.

MP3 files contain compressed audio data. MP3 encoding is capable of compressing audio data at extremely high ratios, reducing the size of music files to as much as one-tenth their original size. This is achieved while still maintaining near CD quality. The MP3 format realizes such high compression ratios by eliminating the sounds that are either inaudible to the human ear or masked by other sounds.

What is WMA?

WMA, or "Windows Media™ Audio," is compressed audio data.

WMA is similar to MP3 audio data.

What is AAC?

AAC is the abbreviation for "Advanced Audio Coding," and is a basic format of audio compression used by MPEG2 or MPEG4.

What is FLAC?

FLAC (Free Lossless Audio Codec) is an audio file codec for lossless compression, developed and offered as open source software.

Codecs with lossy compression forms, such as MP3 and AAC, reduce part of the data to improve compression efficiency.

However, FLAC can reconstruct compressed data to be an identical copy of the original data by performing lossless compression. The compression ratio of FLAC is about 50%.

Method for creating MP3/WMA/AAC/FLAC/WAV (USB Flash drive) files

Audio data is compressed using software with MP3/WMA/AAC/FLAC/WAV (USB Flash drive) codecs. For details on creating MP3/WMA/AAC/FLAC/WAV (USB Flash drive) files, refer to the user's manual for that software.

MP3/WMA/AAC/FLAC/WAV (USB Flash drive) files that are playable on this device have the file extensions.

MP3: "mp3"

WMA: "wma"

AAC: "m4a"

FLAC: "flac"/"fla"

WAV: "wav"

WMA is not supported for the following files, Windows Media Audio Professional, Windows Media Audio 10 std or Windows Media Audio 10 Pro Lossless.

There are many different versions of the AAC format. Confirm that the software being used conforms to the acceptable formats listed above. It's possible that the format may be unplayable even though the extension is valid.

Playback of AAC files encoded by iTunes is supported.

Supported playback sampling rates and bit rates

MP3 (USB Flash drive)

Sampling rates: 8 kHz, 11.025 kHz, 12 kHz,
16 kHz, 22.05 kHz, 24 kHz,
32 kHz, 44.1 kHz, 48 kHz

Bit rates: 8 - 320 kbps

WMA (USB Flash drive)

Sampling rates: 8 - 48 kHz

Bit rates: 8 - 384 kbps

AAC (USB Flash drive)

Sampling rates: 8 - 48 kHz

Bit rates: 8 - 384 kbps

FLAC (USB Flash drive)

Sampling rates: 8 - 48 kHz

Bit rates: 8 - 384 kbps

WAV (USB Flash drive)

Sampling rates: 8 - 48 kHz

Bit rates: 64 - 1,536 kbps

This device may not play back correctly depending on sampling rates.

ID3 tags/WMA tags

This device supports ID3 tag v1.0, v1.1, v2.2, v2.3, v2.4, and WMA tag Ver.1.x. If tag data is in an MP3/WMA/AAC file, this device can display the title (track title), artist name, and album name ID3 tag/WMA tag data. For non-supported characters, “?” is displayed. The number of characters may be limited, or not correctly displayed, depending on the tag information.

Playing back MP3/WMA/AAC/FLAC/WAV

MP3/WMA/AAC files are prepared, then written to a USB flash drive.

- Maximum numbers of playable files/folders
USB Flash drive: 10,000 files/folders (including Root Folder)
- Largest playable file size: 512 MB

Playback may not be performed if a USB flash drive exceeds the limitations described above.

If a file/folder name is long, the maximum possible number of files may decrease.

- Both Audio and Video files are counted if their formats are playable on this unit.

Media supported

The media that this device can play back a USB flash drive.

Corresponding File Systems

This device supports FAT 16/32.

The maximum nested folder depth is 8 (including the root directory). File names are limited to 256 characters (including the extension).

Valid characters for folder/file names are letters A-Z (all caps), numbers 0-9, and ‘_’ (underscore).

Order of files

Files are played back in the order that the writing software writes them to the USB flash drive. Therefore, the playback order may not be what’s expected. Verify the writing order in the software’s documentation. The playback order of the folders and files is as follows. (The following numbers may differ from actually displayed numbers.)

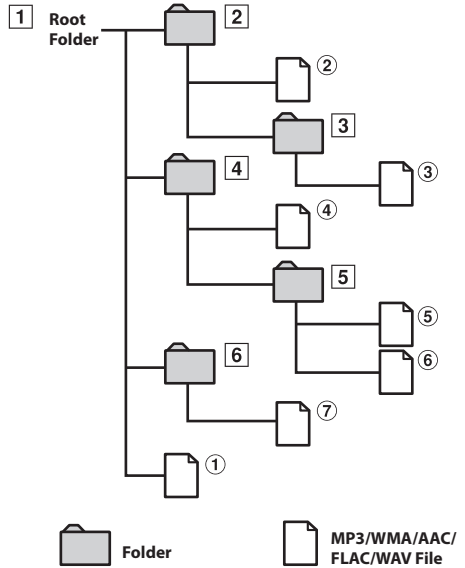

Terminology

Bit rate

This is the “sound” compression rate specified for encoding. The higher the bit rate, the higher the sound quality, but also the larger the files.

Sampling rate

This value shows how many times per second the data is sampled (recorded). For example, music CDs use a sampling rate of 44.1 kHz, so the sound is sampled (recorded) 44,100 times per second. The higher the sampling rate, the higher the sound quality, but also the larger the volume of data.

Encoding

Converting music CDs, WAVE (AIFF) files, and other sound files into the specified audio compression format.

Tag

Song information such as track titles, artist names, album names, etc., written into MP3/WMA/AAC/FLAC/WAV (USB flash drive) files.

Root folder

The root folder (or root directory) is found at the top of the file system. The root folder contains all folders and files. It is created automatically for all USB flash drive.

In Case of Difficulty

If you encounter a problem, please turn the power off, then on again. If the unit is still not functioning normally, please review the items in the following checklist. This guide will help you isolate the problem if the unit is at fault. Otherwise, make sure the rest of your system is properly connected, or then consult your authorized Alpine dealer.

Basic

No function or display.

- Vehicle's ignition is off.
 - If connected according to the instructions, the unit will not operate with the vehicle's ignition off.
- Improper power lead connections.
 - Check power lead connections.
- Blown fuse.
 - Check the fuse on the battery lead of the unit; replace with the proper value if necessary.

No sound or unnatural sound.

- Incorrect setting of volume/balance/fader controls.
 - Readjust the controls.
- Connections are not properly or securely made.
 - Check the connections and firmly connect.

Screen not displayed.

- Brightness/Contrast control is set at the minimum position.
 - Adjust the Brightness/Contrast control.
- Temperature in the vehicle is too low.
 - Increase the vehicle's interior temperature to operation temperature range.
- Connections to the Auxiliary Device are not securely made.
 - Check the connections and firmly connect.
- The Parking Brake Lead is not connected.
- The Parking Brake is not engaged.
 - Connect the Parking Brake Lead, then engage the Parking Brake.

Movement of displayed picture is abnormal.

- Temperature in the vehicle is too high.
 - Allow the vehicle's interior temperature to cool.

Radio

Unable to receive stations.

- No antenna, or open connection in the antenna cable.
 - Make sure the antenna is properly connected; replace the antenna or cable if necessary.

Unable to tune stations in the seek mode.

- You are in a weak signal area.
 - Make sure the tuner is in DX mode.
- If the area you are in is a primary signal area, the antenna may not be grounded and connected properly.
 - Check your antenna connections; make sure the antenna is properly grounded at its mounting location.
- The antenna may not be the proper length.
 - Make sure the antenna is fully extended; if broken, replace the antenna with a new one.

Broadcast is noisy.

- The antenna is not the proper length.
 - Extend the antenna fully; replace it if it is broken.
- The antenna is poorly grounded.
 - Make sure the antenna is grounded properly at its mounting location.
- The station signal is weak and noisy.
 - If above solution does not work, tune in another station.

USB Audio

Unit does not operate.

- Condensation.
 - Wait a while (about 1 hour) for the condensation to dry.

Picture is unclear or noisy.

- Vehicle's battery power is weak.
 - Check the battery power and wiring.
(The unit may malfunction if the battery power is under 11 volts with a load applied.)

Handsfree Phone

Ringtone is small

- Depending on your phone, the ringtone volume may be small, it is not a failure.

If this Message Appears

Various messages are displayed on the screen during operation. In addition to the messages telling you the current status or providing guidance for the next operation, there are also the following error messages. If one of these error messages is displayed, carefully follow the instructions in the solution column.

System

This operation is prohibited for your safety.

- A setup operation, etc., was carried out while the vehicle was running.
 - Move the vehicle to a safe location, stop, and engage the parking brake, then carry out this operation.

Unsupported USB device connected.

- A USB flash drive with a hub is connected.
 - You cannot play back from a USB flash drive with a hub. USB hub connections are also not supported.
-

Audio/Visual

Unsupported USB device connected.

- An iPhone that is not supported by the unit is connected.
 - Connect an iPhone that is supported by the unit.
- A USB device that is not supported by the unit is connected.
 - Attempt to connect another USB flash drive.
- Communication error.
 - Turn the ignition key off, and then set to ON again.
 - Check the display by reconnecting between the iPhone and the unit, using the iPhone cable.
 - Check the display by reconnecting between the USB flash drive and the unit.
- Caused by the iPod/iPhone Software Version not being compatible with this unit.
 - Update the iPhone Software Version to be compatible with this unit.
- The iPhone is not verified.
 - Change to another iPhone.

No Song

- There are no data in the iPhone.
 - Download data to the iPhone and connect to the unit.

No File

- There are no data in the USB flash drive.
 - Download data to the USB flash drive and connect to this unit.

File format not supported.

- A copy-protected WMA file has been detected.
 - You can only play back non-copy-protected files.
- A sampling rate/bit rate not supported by the unit is used.
 - Use a sampling rate/bit rate supported by the unit.

DAB Antenna error

- The DAB antenna cable is either damaged or not connected correctly to the product.
 - Check that the antenna cable is not kinked or otherwise damaged. Replace the antenna if necessary.
- Abnormal current is run to the DAB Antenna.
 - Connect the antenna properly to a car with a 12 volt negative ground.

Bluetooth

No Bluetooth

- The Bluetooth audio device was not connected correctly.
 - Check the settings for the unit and the Bluetooth audio device and reconnect.
-

Specifications

MONITOR SECTION

Screen Size	6.95"
LCD Type	Transparent type TN LCD
Operation System	TFT active matrix
Number of Picture Elements	1,152,000 pcs. (800 × 480 × 3 (RGB))
Effective Number of Picture Elements	99% or more
Illumination System	LED

FM TUNER SECTION

Tuning Range	87.5 – 108.0 MHz
Mono Usable Sensitivity	9.3 dBf (0.8 μ V/75 ohms)
50 dB Quieting Sensitivity	13.5 dBf (1.3 μ V/75 ohms)
Alternate Channel Selectivity	80 dB
Signal-to-Noise Ratio	65 dB
Stereo Separation	35 dB
Capture Ratio	2.0 dB

AM TUNER SECTION

Tuning Range	531 – 1,602 kHz
Usable Sensitivity	25.1 μ V/28 dBf

DAB SECTION

Tuning Range	174.928 – 239.2 MHz
Usable Sensitivity	-92 dBm
Signal-to-Noise Ratio BAND III	70 dB
Distortion BAND III	0.2 %

USB SECTION

USB requirements	USB 2.0
Max. Power Consumption	1,500 mA (CDP Support)
USB Class	USB (Play From Device)/ USB (Mass Storage Class)
File System	FAT16/32
Number of Channels	2-Channels (Stereo)
Frequency Response*1	5 – 20,000 Hz (±1 dB)
Total Harmonic Distortion	0.008% (at 1 kHz)
Dynamic Range	95 dB (at 1 kHz)
Signal-to-Noise Ratio	100 dB
Channel Separation	85 dB (at 1 kHz)

*1 Frequency response may differ depending on the encoder software/bit rate.

HDMI SECTION

Input Format	720p/480p/VGA
--------------	---------------

Bluetooth SECTION

Bluetooth Specification	Bluetooth V4.1 (2,402 - 2,480 MHz)
Output Power	+4 dBm Ave. (Power class 2)
Profile	HFP (Hands-Free Profile) PBAP (Phone Book Access Profile) A2DP (Advanced Audio Distribution Profile) AVRCP (Audio/Video Remote Control Profile)

GENERAL

Power Requirement	14.4 V DC (11–16 V allowable)
Operating temperature	-20°C to + 60°C
Power Output	50 W × 4
Weight	1.0 kg
Audio output level	Preout (Front, Rear): 4V/10k ohms (max.) Preout (Subwoofer): 4V/10k ohms (max.)

CHASSIS SIZE

Width	178 mm
Height	100 mm
Depth	60 mm

- *Due to continuous product improvement, specifications and design are subject to change without notice.*
- *The LCD panel is manufactured using an extremely high precision manufacturing technology. Its effective pixel ratio is over 99.99%. This means that there is a possibility that 0.01% of the pixels could be either always ON or OFF.*

Installation and Connections

Before installing or connecting the unit, please read the following and pages 6 to 7 of this manual thoroughly for proper use.

WARNING

KEEP SMALL OBJECTS SUCH AS SCREWS OUT OF THE REACH OF CHILDREN.

Swallowing them may result in serious injury. If swallowed, consult a physician immediately.

MAKE THE CORRECT CONNECTIONS.

Failure to make the proper connections may result in fire or product damage.

USE ONLY IN CARS WITH A 12 VOLT NEGATIVE GROUND.

(Check with your dealer if you are not sure.) Failure to do so may result in fire, etc.

BEFORE WIRING, DISCONNECT THE CABLE FROM THE NEGATIVE BATTERY TERMINAL.

Failure to do so may result in electric shock or injury due to electrical shorts.

DO NOT ALLOW CABLES TO BECOME ENTANGLED IN SURROUNDING OBJECTS.

Arrange wiring and cables in compliance with the manual to prevent obstructions when driving. Cables or wiring that obstruct or hang up on places such as the steering wheel, gear lever, brake pedals, etc. can be extremely hazardous.

DO NOT SPLICE INTO ELECTRICAL CABLES.

Never cut away cable insulation to supply power to other equipment. Doing so will exceed the current carrying capacity of the wire and result in fire or electric shock.

DO NOT DAMAGE PIPE OR WIRING WHEN DRILLING HOLES.

When drilling holes in the chassis for installation, take precautions so as not to contact, damage or obstruct pipes, fuel lines, tanks or electrical wiring. Failure to take such precautions may result in fire.

DO NOT USE BOLTS OR NUTS IN THE BRAKE OR STEERING SYSTEMS TO MAKE GROUND CONNECTIONS.

Bolts or nuts used for the brake or steering systems (or any other safety-related system), or tanks should NEVER be used for installations or ground connections. Using such parts could disable control of the vehicle and cause fire etc.

DO NOT INSTALL IN LOCATIONS WHICH MIGHT HINDER VEHICLE OPERATION, SUCH AS THE STEERING WHEEL OR SHIFT LEVER.

Doing so may obstruct forward vision or hamper movement etc. and results in serious accident.

CAUTION

HAVE THE WIRING AND INSTALLATION DONE BY EXPERTS.

The wiring and installation of this unit requires special technical skill and experience. To ensure safety, always contact the dealer where you purchased this product to have the work done.

USE SPECIFIED ACCESSORY PARTS AND INSTALL THEM SECURELY.

Be sure to use only the specified accessory parts. Use of other than designated parts may damage this unit internally or may not securely install the unit in place. This may cause parts to become loose resulting in hazards or product failure.

ARRANGE THE WIRING SO IT IS NOT CRIMPED OR PINCHED BY A SHARP METAL EDGE.

Route the cables and wiring away from moving parts (like the seat rails) or sharp or pointed edges. This will prevent crimping and damage to the wiring. If wiring passes through a hole in metal, use a rubber grommet to prevent the wire's insulation from being cut by the metal edge of the hole.

DO NOT INSTALL IN LOCATIONS WITH HIGH MOISTURE OR DUST.

Avoid installing the unit in locations with high incidence of moisture or dust. Moisture or dust that penetrates into this unit may result in product failure.

Precautions

- Be sure to disconnect the cable from the (-) battery post before installing your unit. This will reduce any chance of damage to the unit in case of a short-circuit.
- Be sure to connect the colour coded leads according to the diagram. Incorrect connections may cause the unit to malfunction or damage to the vehicle's electrical system.
- When making connections to the vehicle's electrical system, be aware of the factory installed components (e.g. on-board computer). Do not tap into these leads to provide power for this unit. When connecting the unit to the fuse box, make sure the fuse for the intended circuit of the unit has the appropriate amperage. When in doubt, consult your Alpine dealer.
- The unit uses female RCA-type jacks for connection to other units (e.g. amplifier) having RCA connectors. You may need an adaptor to connect other units. If so, please contact your authorized Alpine dealer for assistance.
- Be sure to connect the speaker (-) leads to the speaker (-) terminal. Never connect left and right channel speaker cables to each other or to the vehicle body.

Accessory List

Main unit	1
Quick Reference Guide.....	1 set
<Cables>	
Power cable.....	1
USB extension cable.....	1
PRE OUT cable.....	1
Microphone.....	1
CAN Interface Connector	1
<Main unit mounting parts>	
Screw (M5×8).....	4

Installation

Caution

- Do not block the unit's fan, thus preventing air circulation. If blocked, heat will accumulate inside the unit and may cause a fire.

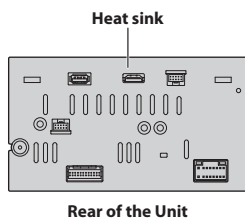

Caution concerning the installation location

Angle of installation

Install at an angle between horizontal and 30°. Note that installing at an angle outside of this range will result in a loss of performance and possibly damage.

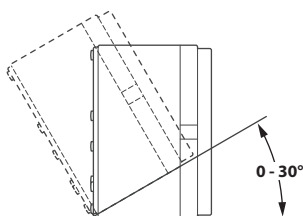

Mounting the Microphone

For safe use, make sure of the following:

- Location is stable and firm.
- Does not interfere with safety equipment.
- Driver's view and operations are not obstructed.
- Microphone is located where the driver's voice can be easily picked up (for example, on the sun visor).

When you speak into the microphone, you should not have to change your driving posture. This may cause a distraction, taking your attention away from safely driving your vehicle. Carefully consider direction and distance while mounting the microphone. Confirm that the driver's voice can be easily picked up at the selected location.

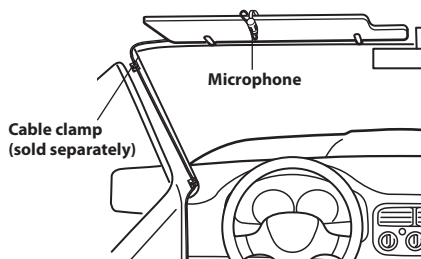

Installation example using the Original Mounting Bracket

- Mount the original mounting bracket to the unit using the supplied screws.

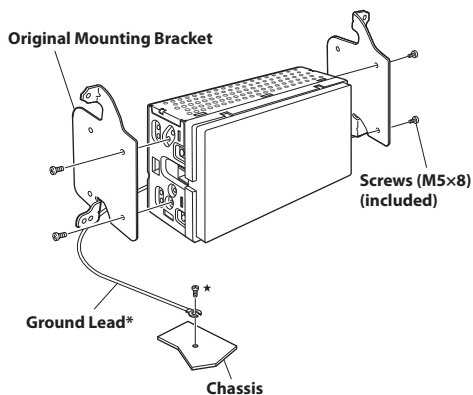

- Connect all other leads of the unit according to details described in the "Connections" (page 61).

- Mount the unit in a car.

* To securely connect the ground lead, use an already installed screw on a metal part of the vehicle (marked (★)) or a clean, bare metal spot on the vehicle's chassis.

- Fix the cables carefully. Do not damage them by mounting them into movable parts, such as the seat rail, or by locating them against sharp or pointed edges.

- Reattach the removed vehicle parts (panels, etc.) or other aftermarket dash kit back onto the vehicle.

Connections

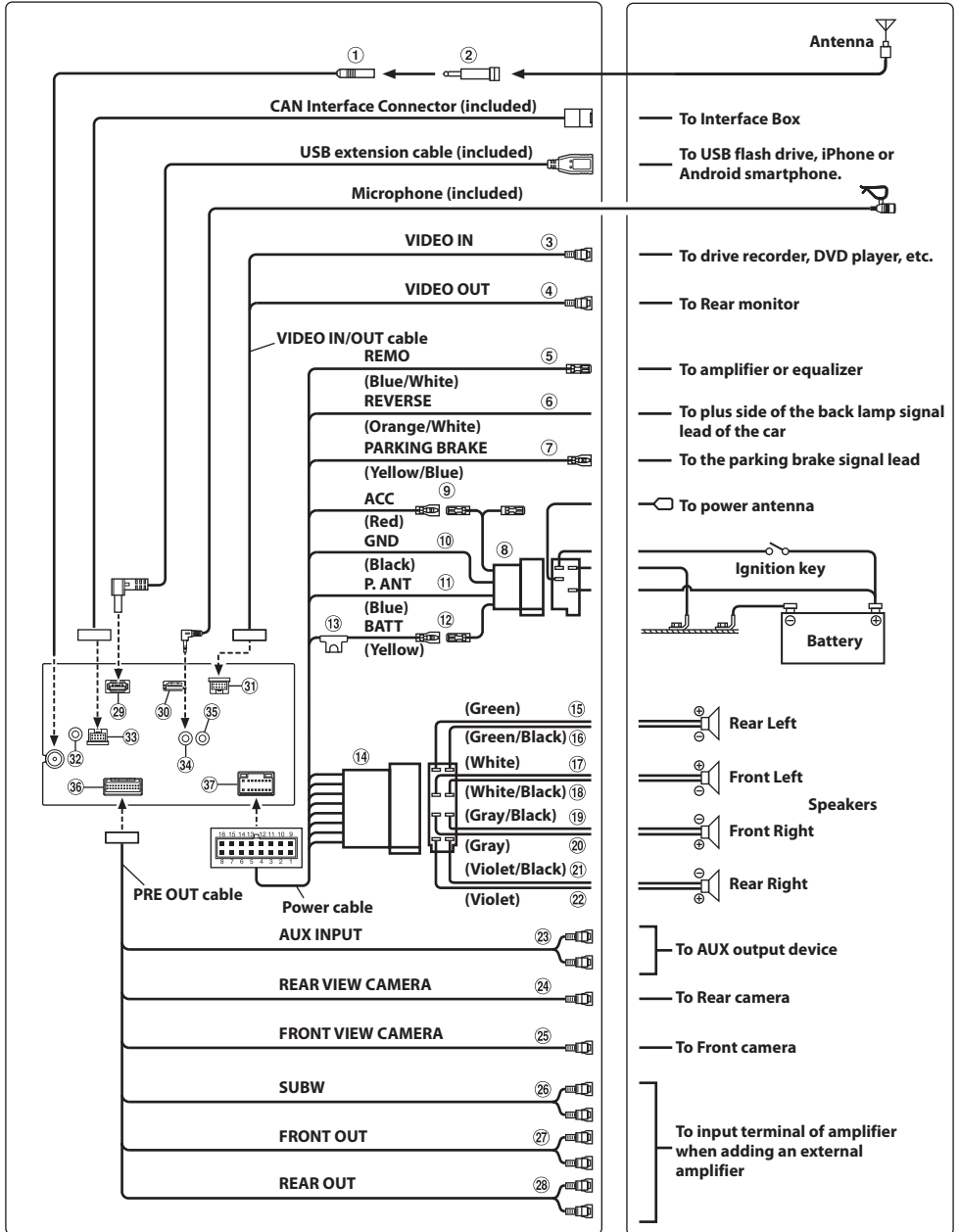

- ① Radio Antenna Receptacle
- ② ISO/JASO Antenna Adapter (sold separately)
ISO/JASO Antenna Adapter may be required, depending on the vehicle.
- ③ Video Input Lead
- ④ Video Output Lead
- ⑤ Remote Turn-On Lead (Blue/White)
Connect this lead to the remote turn-on lead of your amplifier or signal processor.
- ⑥ Reverse Lead (Orange/White)
- ⑦ Parking Brake Lead (Yellow/Blue)
Connect this lead to the power supply side of parking brake switch to transmit the parking brake status signals to the unit.
- ⑧ ISO Power Supply Connector
- ⑨ Switched Power Lead (Ignition) (Red)
Connect this lead to an open terminal on the vehicle's fuse box or another unused power source that provides (+) 12V only when the ignition is turned on or in the accessory position.
- ⑩ Ground Lead (Black)
Connect this lead to a good chassis ground on the vehicle.
Make sure the connection is made to bare metal and is securely fastened using the sheet metal screw provided.
- ⑪ Power Antenna Lead (Blue)
Connect this lead to the +B terminal of your power antenna, if applicable.
* This lead should be used only for controlling the vehicle's power antenna. Do not use this lead to turn on an amplifier or a signal processor, etc.
- ⑫ Battery Lead (Yellow)
Connect this lead to the positive (+) post of the vehicle's battery.
- ⑬ Fuse Holder (15A)
- ⑭ ISO Connector (Speaker Output)
- ⑮ Left Rear (+) Speaker Output Lead (Green)
- ⑯ Left Rear (-) Speaker Output Lead (Green/Black)
- ⑰ Left Front (+) Speaker Output Lead (White)
- ⑱ Left Front (-) Speaker Output Lead (White/Black)
- ⑲ Right Front (-) Speaker Output Lead (Gray/Black)
- ⑳ Right Front (+) Speaker Output Lead (Gray)
- ㉑ Right Rear (-) Speaker Output Lead (Violet/Black)
- ㉒ Right Rear (+) Speaker Output Lead (Violet)

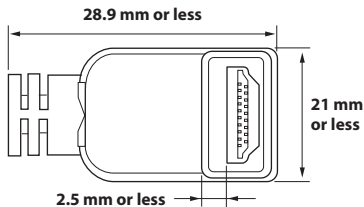
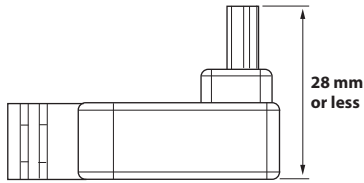
- ㉓ AUX Input Connector
Input lead for AUX audio signal.
 - ㉔ REAR CAMERA Input RCA Connector
Use when connecting a rear camera with RCA Output Connector.
 - ㉕ FRONT CAMER Input RCA Connector
Use when connecting a front camera with RCA Output Connector.
 - ㉖ Subwoofer RCA Connectors
 - ㉗ Front Output RCA Connectors
Can be used as Front Output RCA Connectors. RED is right and WHITE is left.
 - ㉘ Rear Output RCA Connectors
Can be used as Rear Output RCA Connectors. RED is right and WHITE is left.
 - ㉙ USB Connector
To USB flash drive, iPhone or Android smartphone.
 - ㉚ HDMI Input Connector
 - To connect to the HDMI Input Connector, use an optional HDMI cable with an L-Type (270 degree) connector.
 - Please take note of the size of the HDMI cable's L-Type connector. An HDMI cable with a connector exceeding this size will not be able to connect, as it will interfere with the peripheral cables, stacking amplifiers, etc.
- 
- 
- ㉛ VIDEO Input/Output Connector
 - ㉜ DAB Antenna Connector
To DAB Antenna (sold separately).
 - ㉝ Connect2 Connector
To Interface Box.
 - ㉞ MIC Input Connector
To microphone (included).

- ③⑤ Steering Remote Control Interface Connector
To steering remote control interface.
For details about connections, consult your nearest
Alpine dealer.
- ③⑥ AUX/PRE OUT/CAMERA Connector
- ③⑦ Power Supply Connector

If an ACC power supply is not available

Connection Diagram of SPST Switch (sold separately)

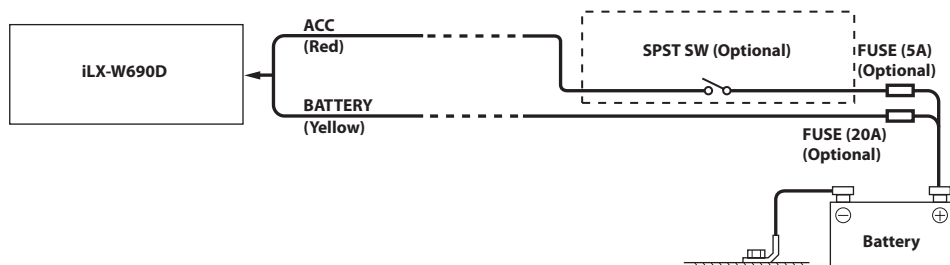

- If your vehicle has no ACC power supply, add an SPST (single-pole, single-throw) switch (sold separately) and fuse (sold separately).
- The diagram and the fuse amperage shown above are in the case when the unit is used individually.
- If the switched power (ignition) lead of the unit is connected directly to the positive (+) post of the vehicle's battery, the unit draws some current (several hundred milliamperes) even when its switch is placed in the OFF position, and the battery may be discharged.

To prevent external noise from entering the audio system.

- Locate the unit and route the leads at least 10 cm away from the car harness.
- Keep the battery power leads as far away from other leads as possible.
- Connect the ground lead securely to a bare metal spot (remove any paint, dirt or grease if necessary) of the car chassis.
- If you add an optional noise suppressor, connect it as far away from the unit as possible. Your Alpine dealer carries various noise suppressors, contact them for further information.
- Your Alpine dealer knows best about noise prevention measures so consult your dealer for further information.

System Example

Connection of an iPhone

■ When connecting to an iPhone with a Lightning connector

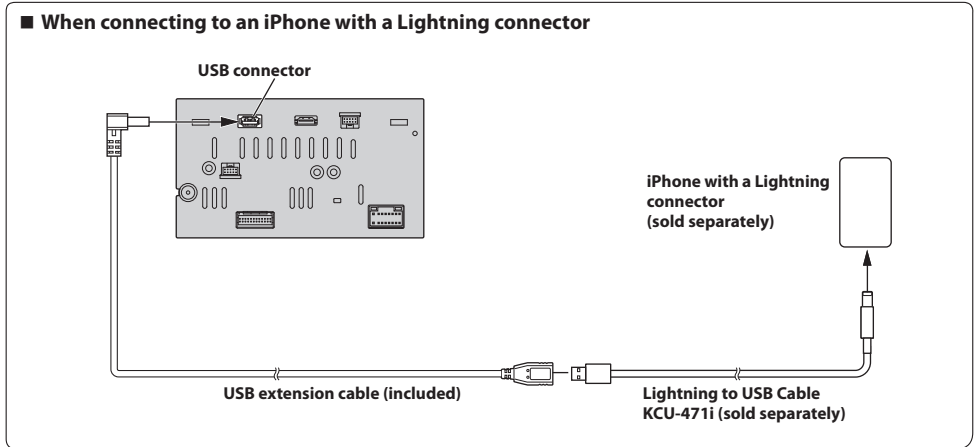

- Do not leave an iPhone in a vehicle for a long time. Heat and humidity may damage the iPhone, and you may not be able to play it again.

Connection of a USB Flash Drive

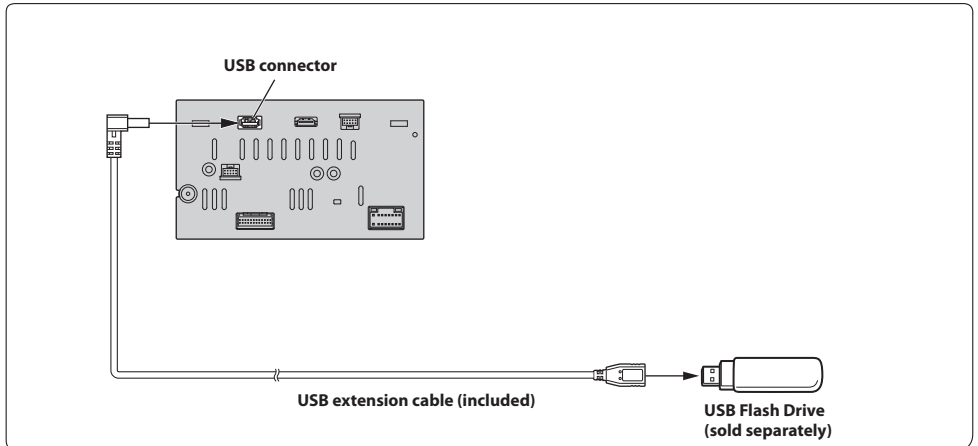

- Do not leave a flash drive in a vehicle for a long time. Heat and humidity may damage the flash drive.

Connection of an HDMI Device (iPhone with a Lightning connector)

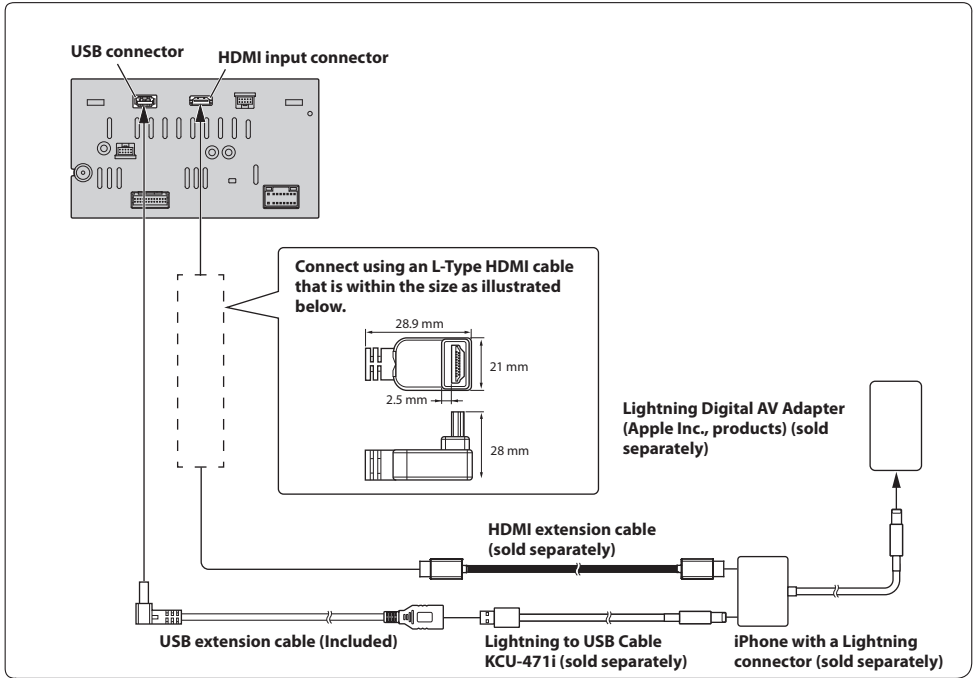

Connection of an HDMI Device (Android device)

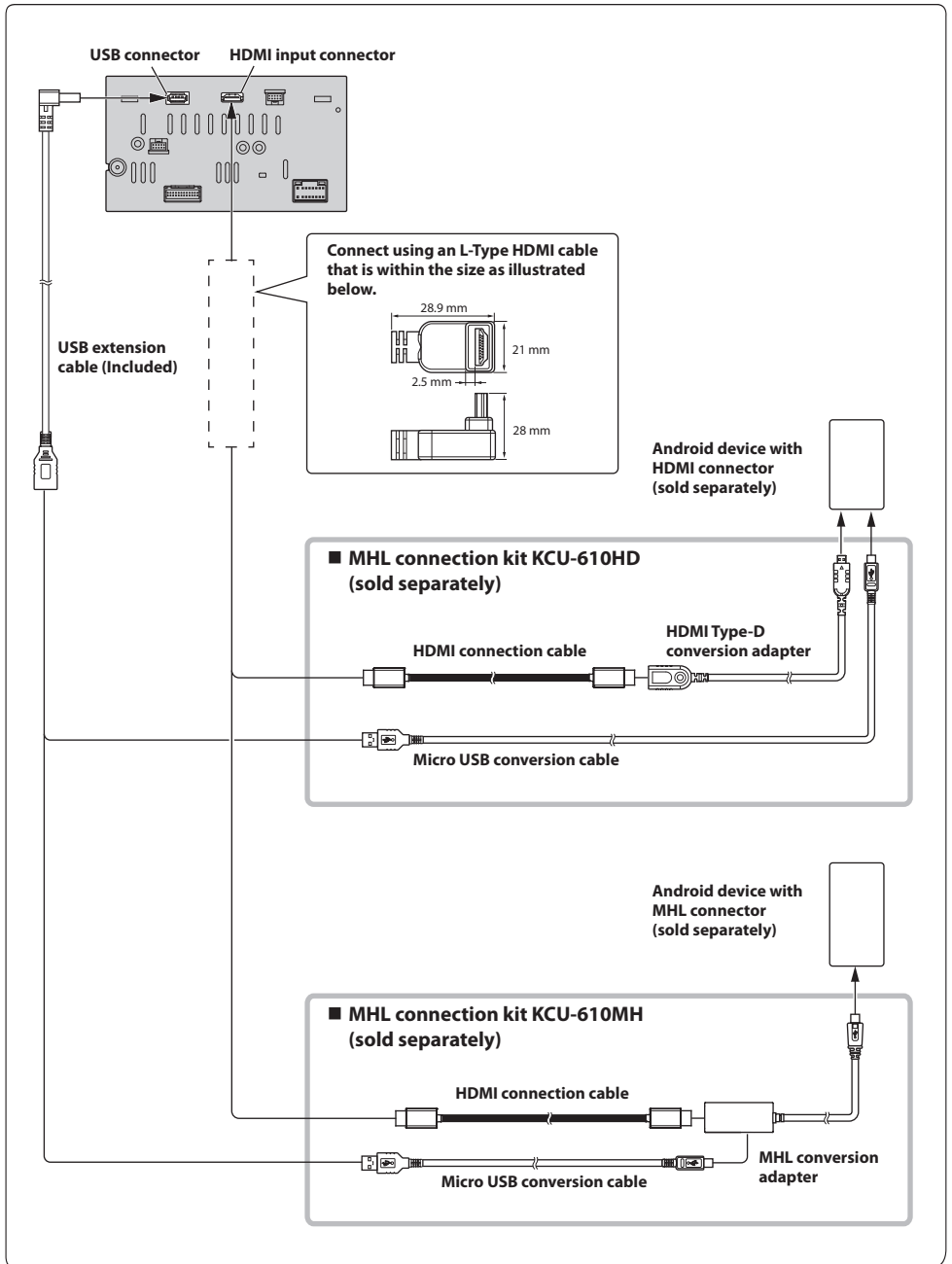

• A connection kit or adapter kit suitable for the type of terminal on the connecting device is required.

Connection of an External Device

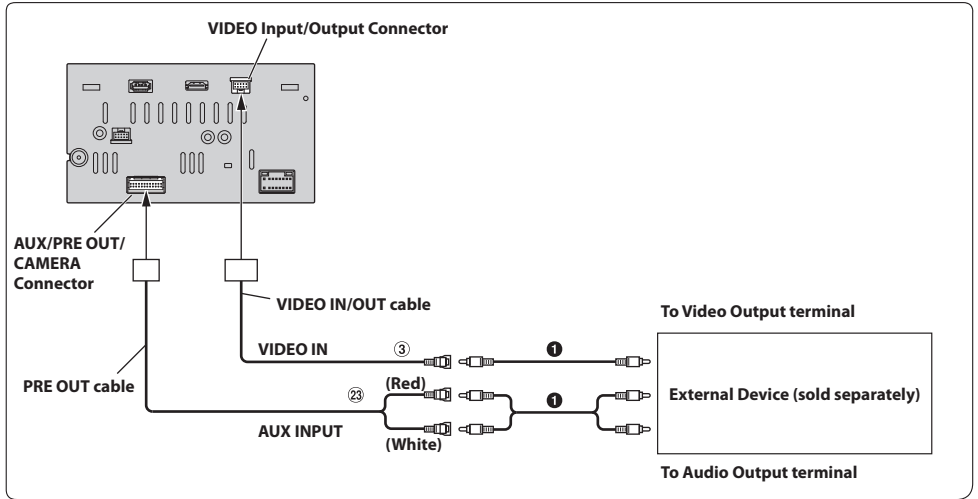

③ Video Input Lead

① RCA Extension Cable (sold separately)

②③ AUX Input Connector

- You can change the name of an external device. For details, refer to “Setting the Auxiliary (AUX) Name” in the OWNER’S MANUAL.

Connection of an External Amplifier

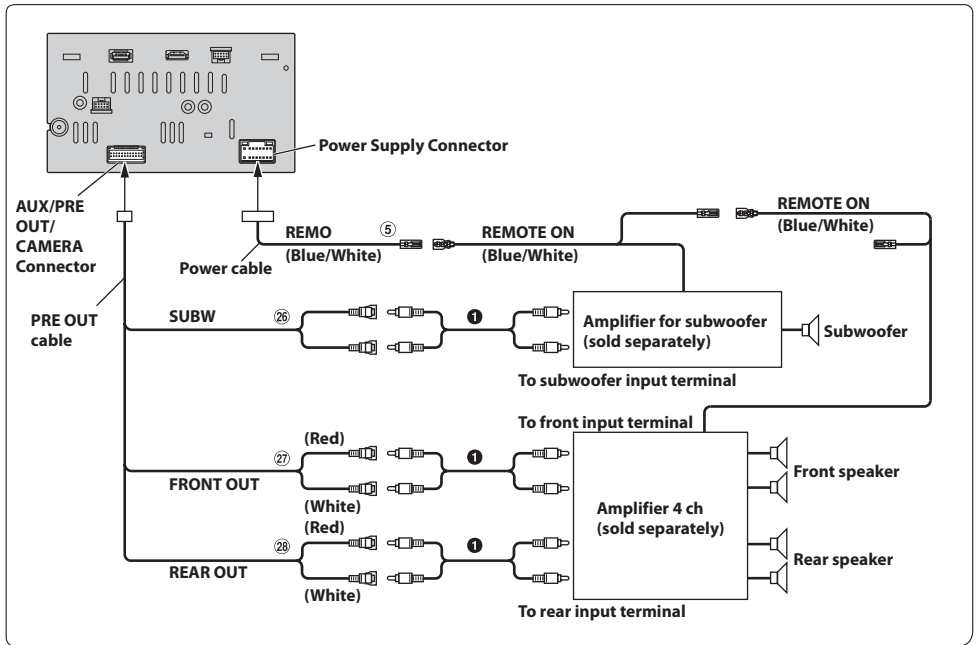

⑤ Remote Turn-On Lead (Blue/White)

① RCA Extension Cable (sold separately)

②⑥ Subwoofer RCA Connectors

②⑦ Front Output RCA Connectors

②⑧ Rear Output RCA Connectors

Connection of a Camera

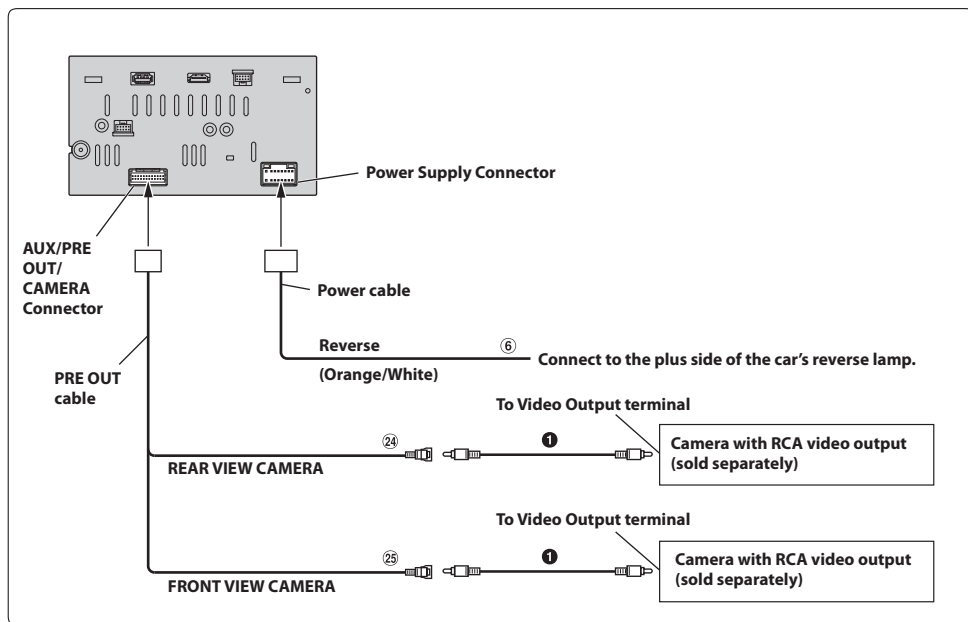

⑥ Reverse Lead (Orange/White)

②④ REAR CAMERA Input RCA Connector

②⑤ FRONT CAMERA Input RCA Connector

① RCA Extension Cable (sold separately)

SIMPLIFIED EU DECLARATION OF CONFORMITY

Hereby, ALPS ALPINE EUROPE GmbH (<https://www.alpine.de/>) declares that the radio equipment type ILX-W690D is in compliance with Directive 2014/53/EU.

The full text of the EU declaration of conformity is available at the following internet address:

<http://www.alpine.com/e/research/doc/>

Compliant with UNECE Regulation 10 (E-Mark)



Hereby, ALPS ALPINE EUROPE GmbH (<https://www.alpine.co.uk/>) declares that the radio equipment type ILX-W690D is in compliance with Radio Equipment Regulations 2017.

The full text of the declaration of conformity is available at the following internet address:

<http://www.alpine.com/e/research/doc/>



[EN] English	Hereby, ALPS ALPINE CO., LTD. declares that the radio equipment type ILX-W690D is in compliance with the relevant statutory requirements. The full text of the UK declaration of conformity is available at the following internet address: http://www.alpine.com/e/research/doc/
[BG] Bulgarian	С настоящото ALPS ALPINE CO., LTD. декларира, че този тип радиос ъоръжение ILX-W690D е в съответствие с Директива 2014/53/ЕС. Цялостният текст на ЕС декларацията за съответствие може да се намери на следния интернет адрес: http://www.alpine.com/e/research/doc/
[CZ] Czech	Tímto ALPS ALPINE CO., LTD. prohlašuje, že typ rádiového zařízení ILX-W690D je v souladu se směrnicí 2014/53/EU. Úplné znění EU prohlášení o shodě je k dispozici na této internetové adrese: http://www.alpine.com/e/research/doc/
[DE] German	Hiermit erklärt ALPS ALPINE CO., LTD., dass der Funkanlagentyp ILX-W690D der Richtlinie 2014/53/EU entspricht. Der vollständige Text der EU-Konformitätserklärung ist unter der folgenden Internetadresse verfügbar: http://www.alpine.com/e/research/doc/
[DK] Danish	Hermed erklærer ALPS ALPINE CO., LTD., at radioudstyrstypen ILX-W690D er i overensstemmelse med direktiv 2014/53/EU. EU-overensstemmelseserklæringens fulde tekst kan findes på følgende internetadresse: http://www.alpine.com/e/research/doc/
[EE] Estonian	Käesolevaga deklareerib ALPS ALPINE CO., LTD. et käesolev raadioseadme tüüp ILX-W690D vastab direktiivi 2014/53/EL nõuetele. Eli vastavusdeklaratsiooni täielik tekst on kättesaadav järgmisel internetiaadressil: http://www.alpine.com/e/research/doc/
[ES] Spanish	Por la presente, ALPS ALPINE CO., LTD. declara que el tipo de equiporadioeléctrico ILX-W690D es conforme con la Directiva 2014/53/UE. El texto completo de la declaración UE de conformidad está disponible en la dirección Internet siguiente: http://www.alpine.com/e/research/doc/
[FI] Finnish	ALPS ALPINE CO., LTD. vakuuttaa, että radiolaitetyyppi ILX-W690D on direktiivin 2014/53/EU mukainen. EU-vaatimustenmukaisuusvakuutuksen täysimittainen teksti on saatavilla seuraavassa internetosoitteessa: http://www.alpine.com/e/research/doc/

[FR] French	Le soussigné, ALPS ALPINE CO., LTD., déclare que l'équipement radioé lectrique du type ILX-W690D est conforme à la directive 2014/53/UE. Le texte complet de la déclaration UE de conformité est disponible à l'adresse internet suivante : http://www.alpine.com/e/research/doc/
[GR] Greek	Με την παρούσα ο/η ALPS ALPINE CO., LTD., δηλώνει ότι ο ραδιοεξοπλισμός ILX-W690D πληροί την οδηγία 2014/53/EE. Το πλήρες κείμενο της δήλωσης συμμόρφωσης ΕΕ διατίθεται στην ακόλουθη ιστ οσελίδα στο διαδίκτυο: http://www.alpine.com/e/research/doc/
[HR] Croatian	ALPS ALPINE CO., LTD. ovime izjavljuje da je radijska oprema tipa ILX-W690D u skladu s Direktivom 2014/53/EU. Cjeloviti tekst EU izjave o sukladnosti dostupan je na sljedećoj internetskoj adresi: http://www.alpine.com/e/research/doc/
[HU] Hungarian	ALPS ALPINE CO., LTD. igazolja, hogy a ILX-W690D típusú rádióberendezé s megfelel a 2014/53/EU irányelvnek. Az EU-megfelelőségi nyilatkozat teljes szövege elérhető a következő internetes címen: http://www.alpine.com/e/research/doc/
[IE] Irish	Foghraíonn ALPS ALPINE CO., LTD., leis seo go bhfuil an cineál trealaimh raidió ILX-W690D in oiriúint le Treoir 2014/53/AE. Tá téacs iomlán an dearbhaithe comhréireachta AE ar fáil ag an seoladh idirlín seo a leanas: http://www.alpine.com/e/research/doc/
[IS] Icelandic	Hér, ALPS ALPINE CO., LTD. lýsir yfir að radióbúnaður tegund ILX-W690D er í samræmi við tilskipun 2014/53/ESB. The fullur texti af ESB-samræmisýfirlýsing er í boði á eftirfarandi veffangi: http://www.alpine.com/e/research/doc/
[IT] Italian	Il fabbricante, ALPS ALPINE CO., LTD., dichiara che il tipo di apparecchiatura radio ILX-W690D è conforme alla direttiva 2014/53/UE. Il testo completo della dichiarazione di conformità UE è disponibile al seguente indirizzo Internet: http://www.alpine.com/e/research/doc/
[LT] Lithuanian	Aš, ALPS ALPINE CO., LTD., patvirtinu, kad radijo įrenginių tipas ILX-W690D atitinka Direktyvą 2014/53/ES. Visas ES atitikties deklaracijos tekstas prieinamas šiuo interneto adresu: http://www.alpine.com/e/research/doc/
[LU] Luxembourgish	ALPS ALPINE CO., LTD., déclare par la présente que l'équipement radio de type ILX-W690D est conforme à la directive 2014/53/UE. La version intégrale de la déclaration européenne de conformité est disponible à l'adresse Internet suivante: http://www.alpine.com/e/research/doc/
[LV] Latvian	Ar šo ALPS ALPINE CO., LTD. deklarē, ka radioiekārta ILX-W690D atbilst Direktīvai 2014/53/ES. Pilns ES atbilstības deklarācijas teksts ir pieejams šādā interneta vietnē: http://www.alpine.com/e/research/doc/
[MT] Maltese	B'dan, ALPS ALPINE CO., LTD., niddikjara li dan it-tip ta' tagħmir tar-radju ILX-W690D huwa konformi mad-Direttiva 2014/53/UE. It-test kollu tad-dikjarazzjoni ta' konformità tal-UE huwa disponibbli f'dan l-indirizz tal-Internet li ġej: http://www.alpine.com/e/research/doc/
[NL] Dutch	Hierbij verklaar ik, ALPS ALPINE CO., LTD., dat het type radioapparatuur ILX-W690D conform is met Richtlijn 2014/53/EU. De volledige tekst van de EU-conformiteitsverklaring kan worden geraadpleegd op het volgende internetadres: http://www.alpine.com/e/research/doc/
[NO] Norwegian	Herved ALPS ALPINE CO., LTD., erklærer at radioutstyr type ILX-W690D er i samsvar med direktiv 2014/53/EU. Den fullstendige teksten i EU-erklæring er tilgjengelig på følgende nettadresse: http://www.alpine.com/e/research/doc/

[PL] Polish	ALPS ALPINE CO., LTD., niniejszym oświadcza, że typ urządzenia radiowego ILX-W690D jest zgodny z dyrektywą 2014/53/UE. Pełny tekst deklaracji zgodności UE jest dostępny pod następującym adresem internetowym: http://www.alpine.com/e/research/doc/
[PT] Portuguese	A abaixo assinada, ALPS ALPINE CO., LTD., declara que o presente tipo de equipamento de rádio ILX-W690D está em conformidade com a Diretiva 2014/53/UE. O texto integral da declaração de conformidade CE está disponível no seguinte endereço de Internet: http://www.alpine.com/e/research/doc/
[RO] Romanian	Prin prezenta, ALPS ALPINE CO., LTD., declară că tipul de echipamente radio ILX-W690D este în conformitate cu Directiva 2014/53/UE. Textul integral al declarației UE de conformitate este disponibil la următoarea adresă internet: http://www.alpine.com/e/research/doc/
[SE] Swedish	Härmed försäkras ALPS ALPINE CO., LTD., att denna typ av radioutrustning ILX-W690D överensstämmer med direktiv 2014/53/EU. Den fullständiga texten till EU-försäkran om överensstämmelse finns på följande webbadress: http://www.alpine.com/e/research/doc/
[SI] Slovenian	ALPS ALPINE CO., LTD., potrjuje, da je tip radijske opreme ILX-W690D skladen z Direktivo 2014/53/EU. Celotno besedilo izjave EU o skladnosti je na voljo na naslednjem spletnem naslovu: http://www.alpine.com/e/research/doc/
[SK] Slovak	ALPS ALPINE CO., LTD., týmto vyhlasuje, že rádiové zariadenie typu ILX-W690D je v súlade so smernicou 2014/53/EÚ. Úplné EÚ vyhlásenie o zhode je k dispozícii na tejto internetovej adrese: http://www.alpine.com/e/research/doc/
[TR] Turkey	ALPS ALPINE CO., LTD., ILX-W690D tipi telsiz cihazın 2014/53/EU sayılı Direktiflere uygun olduğunu beyan eder. AB uygunluk beyanının tam metni şu adreste bulunur: http://www.alpine.com/e/research/doc/



Information on Disposal of Old Electrical and Electronic Equipment and Battery (applicable for countries that have adopted separate waste collection systems)

If you want to dispose this product, do not mix it with general household waste. There is a separate collection system for used electronic products in accordance with legislation that requires proper treatment, recovery and recycling. Contact your local authority for details in locating a recycle facility nearest to you. Proper recycling and waste disposal will help conserve resources whilst preventing detrimental effects on our health and the environment.