

K'NEX

You Build It!
Vous le Construisez!
¡Tú lo Construyes!

AGES / AGE / EDADS

7+

Shark Attack Coaster

*Attaque
de Requin
Montagnes
Russes*

*Ataque de
Tiburón
Montaña
Rusa*



**NEW
Blaster Motor!**
**Nouveau Moteur
de Blaster!**

¡Nuevo Motor
de Impulso!



WARNING:

CHOKING HAZARD – Small parts.
Not for children under 3 years.



Motor/Moteur

AA(LR6) AA(LR6) AA(LR6)

Not Included / Pas Inclus / No se incluyen

(EN) English

Keep this important information for future reference

 **WARNING: CHOKING HAZARD** – Small parts. Not for children under 3 years.

CAUTION: Keep hands, face, hair and clothing away from all moving parts.

CAUTION: Be careful not to tip the model over. Model should be placed on a flat and hard surface.

Do not obstruct track with objects or any part of your body.

Battery Information

How to Insert and Remove Batteries

Use a small Phillips head screwdriver to loosen the screw. Insert 3 fresh AA batteries* (LR6) into the compartment.

* Not included

CAUTION: To Avoid Battery Leakage

- Insert batteries with correct polarity (+/-) as shown.
- Do not mix different types of batteries.
- Do not mix alkaline, standard (carbon-zinc) or rechargeable batteries.
- Do not mix new and used batteries. Only batteries of the same or equivalent type recommended should be used.
- Remove exhausted batteries from the toy; do not short-circuit supply terminals.
- Remove all batteries if the toy will not be used for a long period of time.

Important Tips

- Alkaline batteries are recommended.
- Rechargeable batteries are not recommended.
- Remove rechargeable batteries before recharging; they must be recharged only under adult supervision.
- Non-rechargeable batteries must not be recharged.
- Keep components free of dust; do not immerse or use in water.
- Do not dispose of batteries in a fire; they could leak or explode and cause injury.



The wheeled bin indicates this product cannot be disposed of with household waste due to presence of hazardous substances.

To protect human health and environment, check your local authority for recycling advice and facilities (2012/19/EU, Europe only).

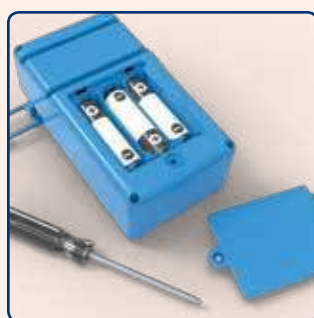

Install batteries before building models.

(FR) Français

Gardez précieusement cette notice pour vous y référer ultérieurement

 **ATTENTION : RISQUE D'ÉTOUFFEMENT** – Pièces de petite taille. Ne convient pas aux enfants de moins de 3 ans.

ATTENTION : Garde les cheveux, les doigts, la figure et les vêtements à l'écart de toutes les pièces mobiles.

ATTENTION : Faire attention de ne pas renverser le modèle. Le modèle devrait être placé sur une surface plate et dure.

Ne pas bloquer les rails avec des objets ou la corps.

Informations sur les Piles

Comment mettre et retirer des piles

Utiliser un petit tournevis pour desserrer la vis et pour enlever le couvercle des piles. Insérer 3 piles AA (LR6)* neuves dans le compartiment. * Pas inclus

ATTENTION : Pour éviter la fuite des piles

- Insérez les piles en respectant la polarité (+/-) comme indiqué.
- Ne pas mélanger différents types de piles.
- Ne pas mélanger des piles alcalines avec des piles standard (carbone-zinc), ou des piles rechargeables.
- Ne pas mélanger des piles neuves avec des piles usées. Il convient d'utiliser uniquement des piles du type recommandé ou d'un type équivalent.
- Retirer toujours les piles faibles ou mortes du produit ; ne pas faire court-circuiter les terminaux.
- Retirez toutes les piles si le jouet ne sera pas utilisé pendant une longue période de temps.

Conseils Importants

- Les piles alcalines sont recommandées.
- Les piles rechargeables ne sont pas recommandées.
- Retirer les piles rechargeables du jouet avant de les recharger; elles doivent être chargées exclusivement en présence d'un adulte.
- Les piles qui ne sont pas rechargeables ne doivent pas être rechargées.
- Veiller à ce que les éléments restent à l'abri de la poussière ; ne pas les plonger ni les utiliser dans l'eau.
- Ne pas jeter les piles dans le feu ; elles risqueraient de fuir ou d'exploser et d'entraîner des blessures.

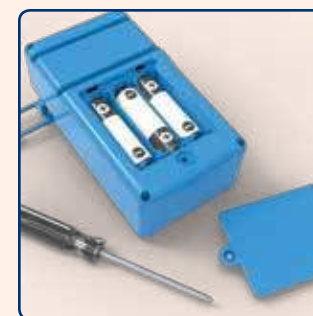

Installe les piles avant de réaliser tes constructions.

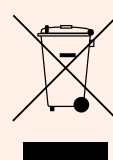

Le symbole "poubelle à roulettes" indique que ce produit ne peut pas être éliminé avec vos déchets ménagers en raison de la présence de substances dangereuses.

Afin de protéger votre santé et l'environnement, renseignez-vous auprès de vos autorités locales afin d'obtenir des conseils sur le recyclage et la localisation des installations adaptées (2012/19/EU, Europe uniquement).

Building Basics

Bases de Construction

Start Building

Each K'NEX piece has its own shape and color. Try to position your model in the same direction as the instructions. Faded colors show you this section is already built.

Démarre ta Construction

Chaque K'NEX pièce a sa propre forme et sa propre couleur. Pour te faciliter la tâche, oriente le modèle dans le même sens que les instructions. Les pièces ayant une couleur estompée sont celles déjà assemblées.

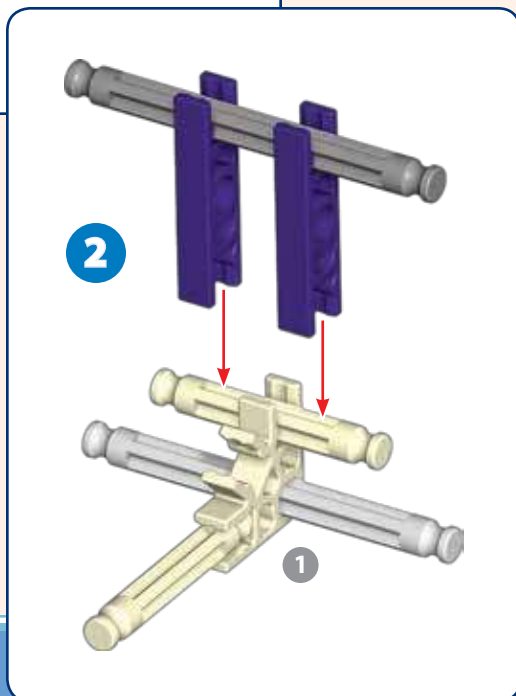
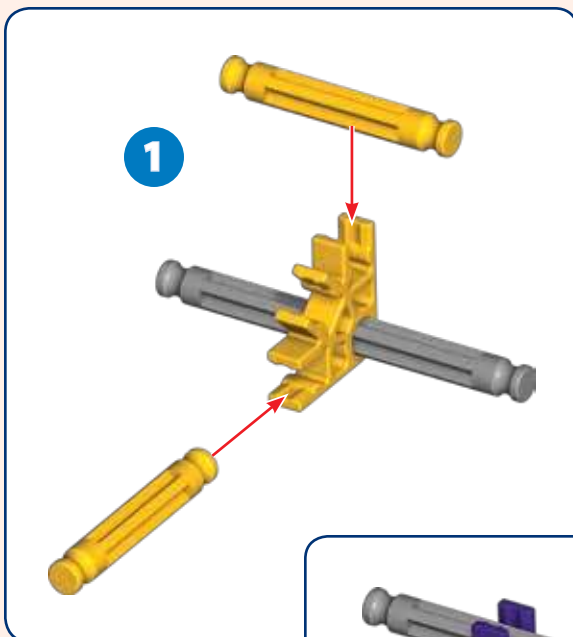

Connectors

Push these special connectors together tightly until you hear a "click".

Connecteurs

Pousse connecteurs spéciaux fort jusqu'à entendre un « clic ».

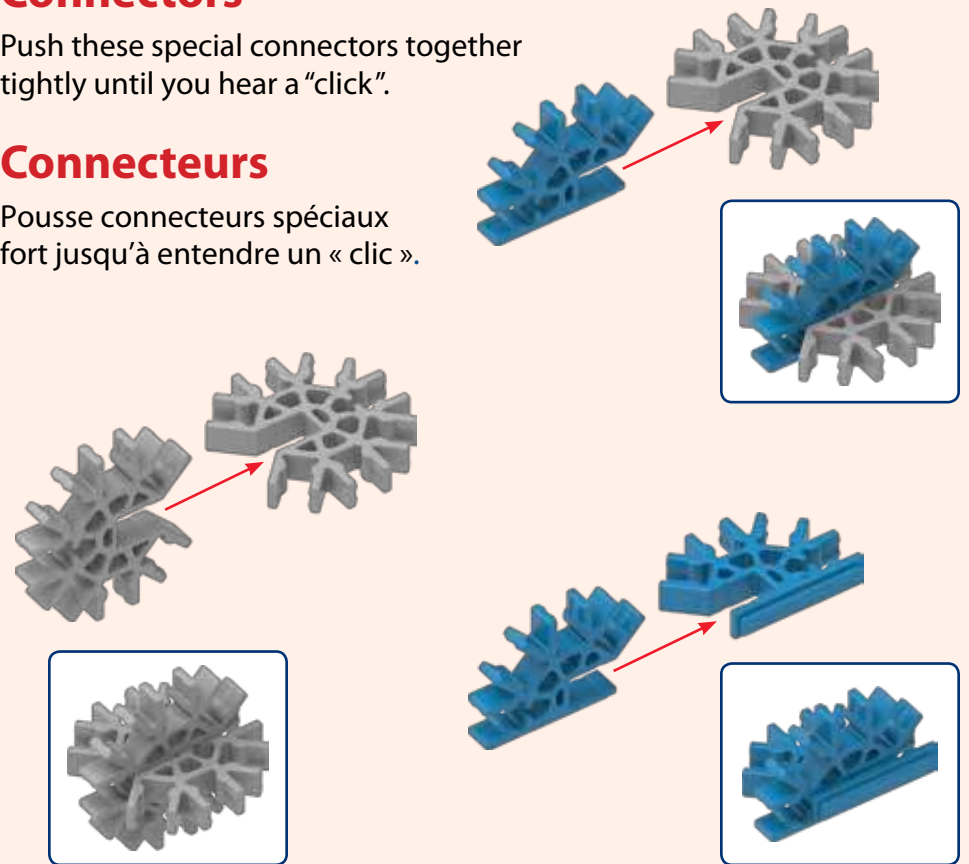

Spacers

Be sure to use the correct color and number of spacers shown.

Séparateurs

Assure-toi d'utiliser la bonne nombre de séparateurs.



k'nex

Tabletop Thrills Shark Attack



TIP: While you're building make sure you face your model in the same direction as the pictures show in the instructions.

CONSEIL : Essaye de situer ton modèle dans le même sens que les instructions durant le montage.

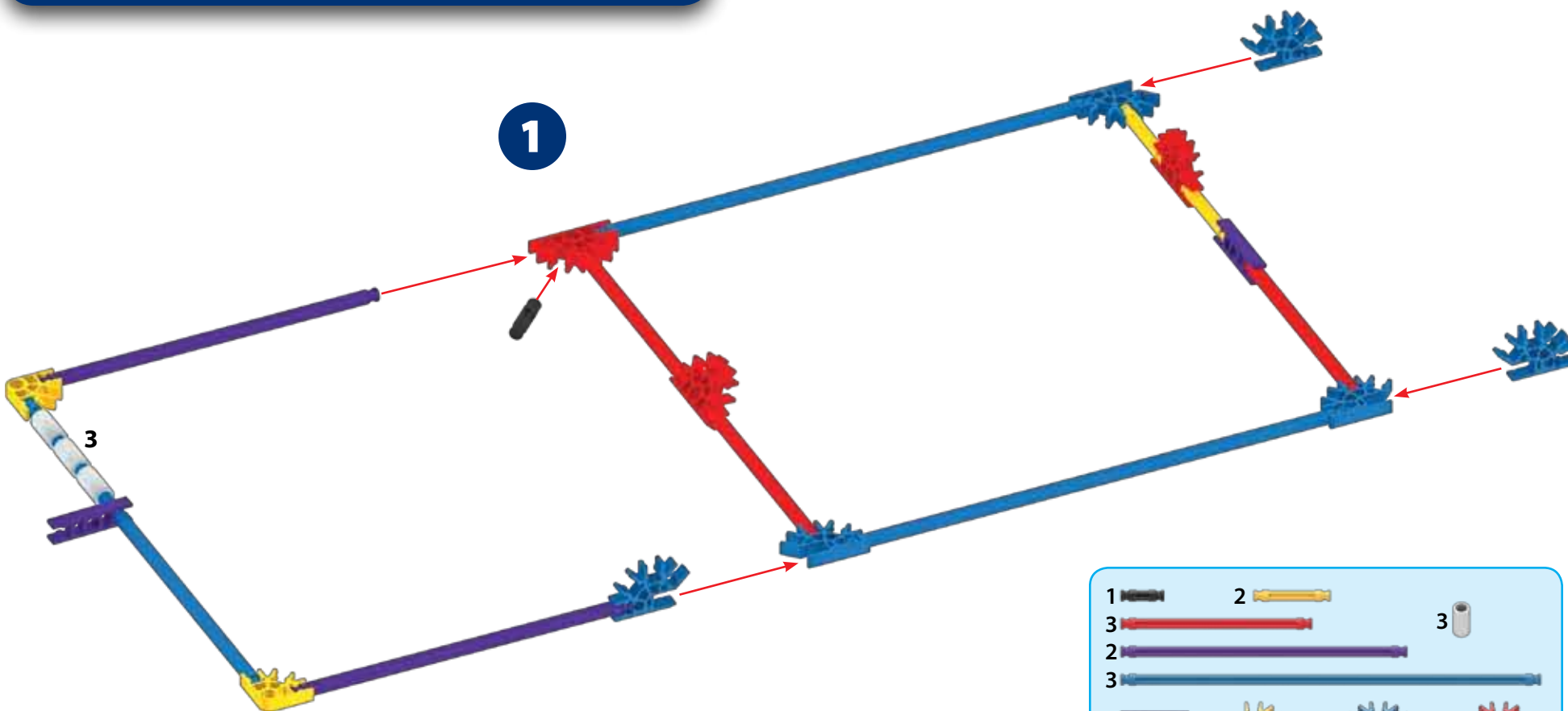
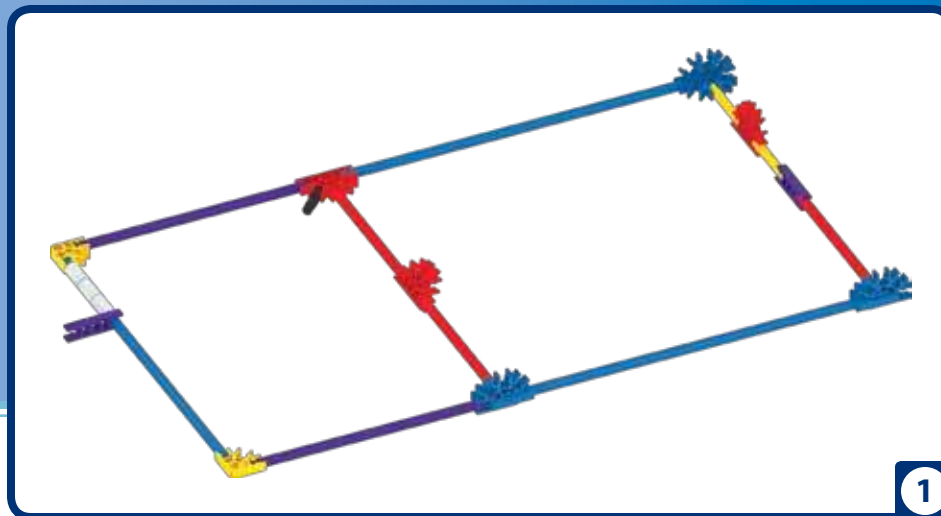

- | | | |
|---|---|---|
| 1 | 2 | |
| 3 | | 3 |
| 2 | | |
| 3 | | |
| 2 | 2 | 6 |
| | | 3 |

4	
3	
1	
3	
1	
3	
1	

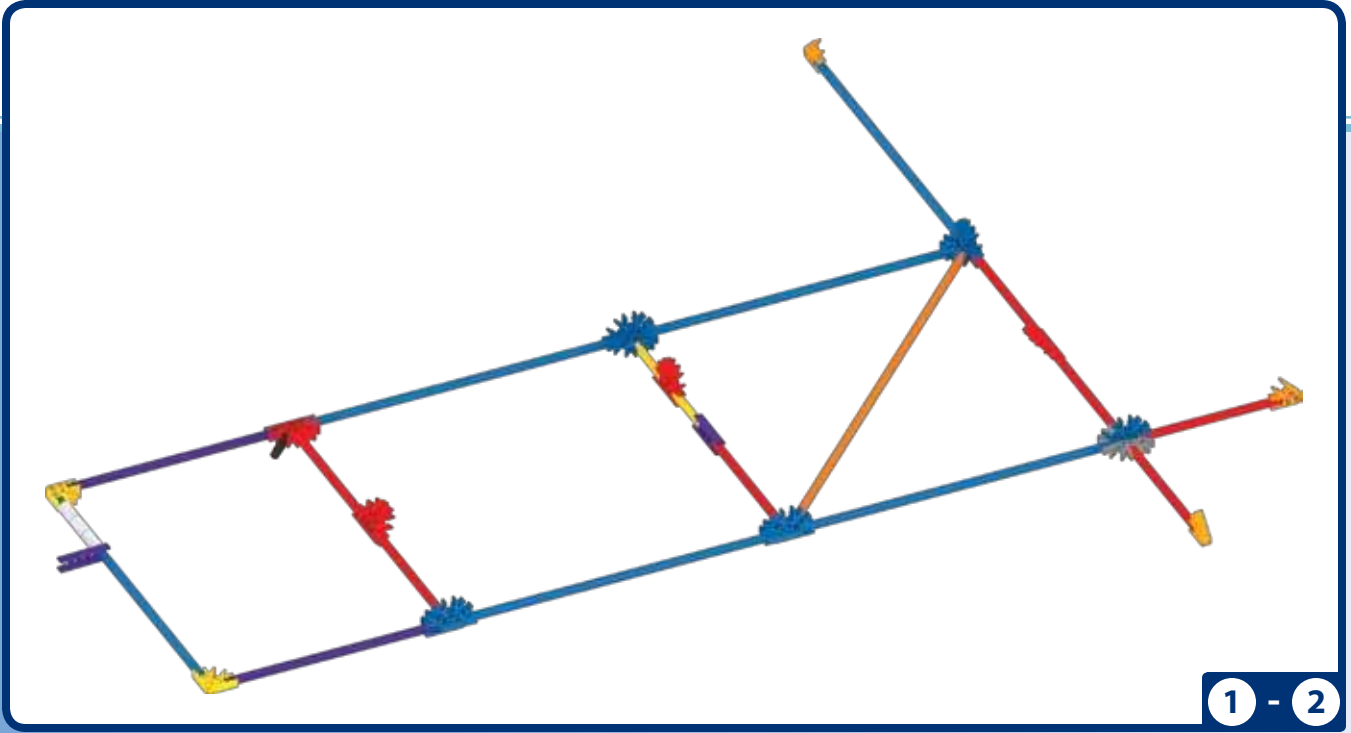
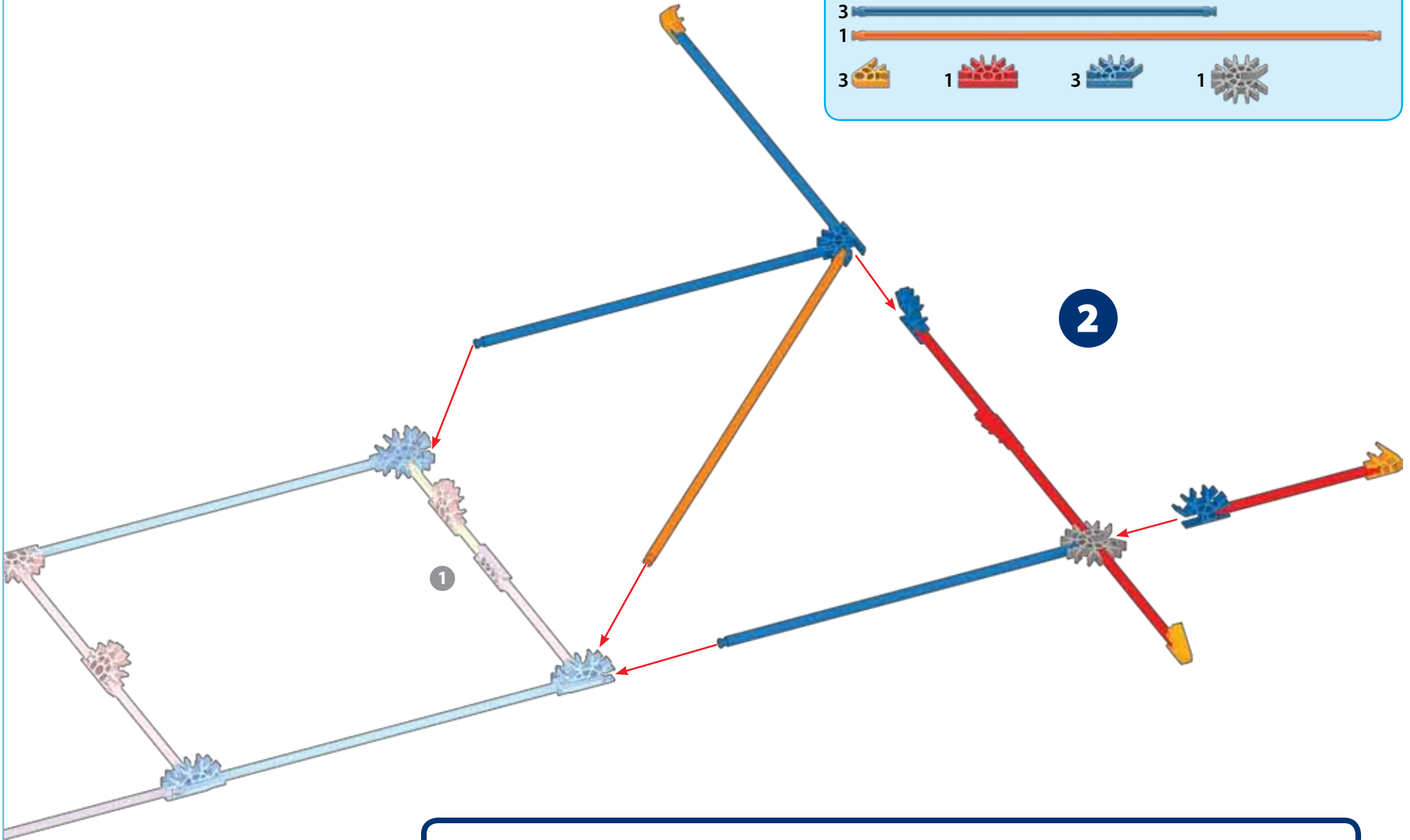

- | | | | |
|---|--|---|--|
| 5 | | 3 | |
| 1 | | 1 | |
| 2 | | | |
| 1 | | 1 | |
| | | 5 | |

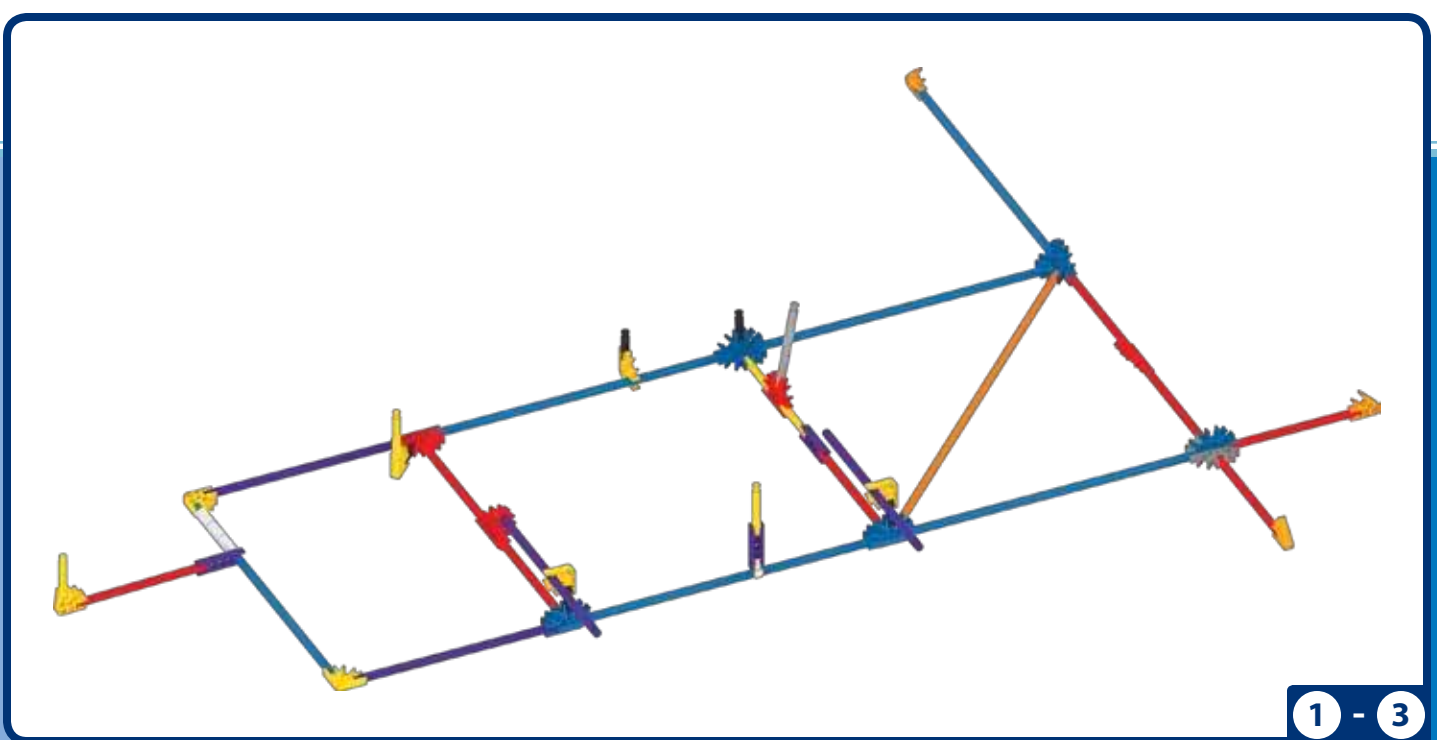
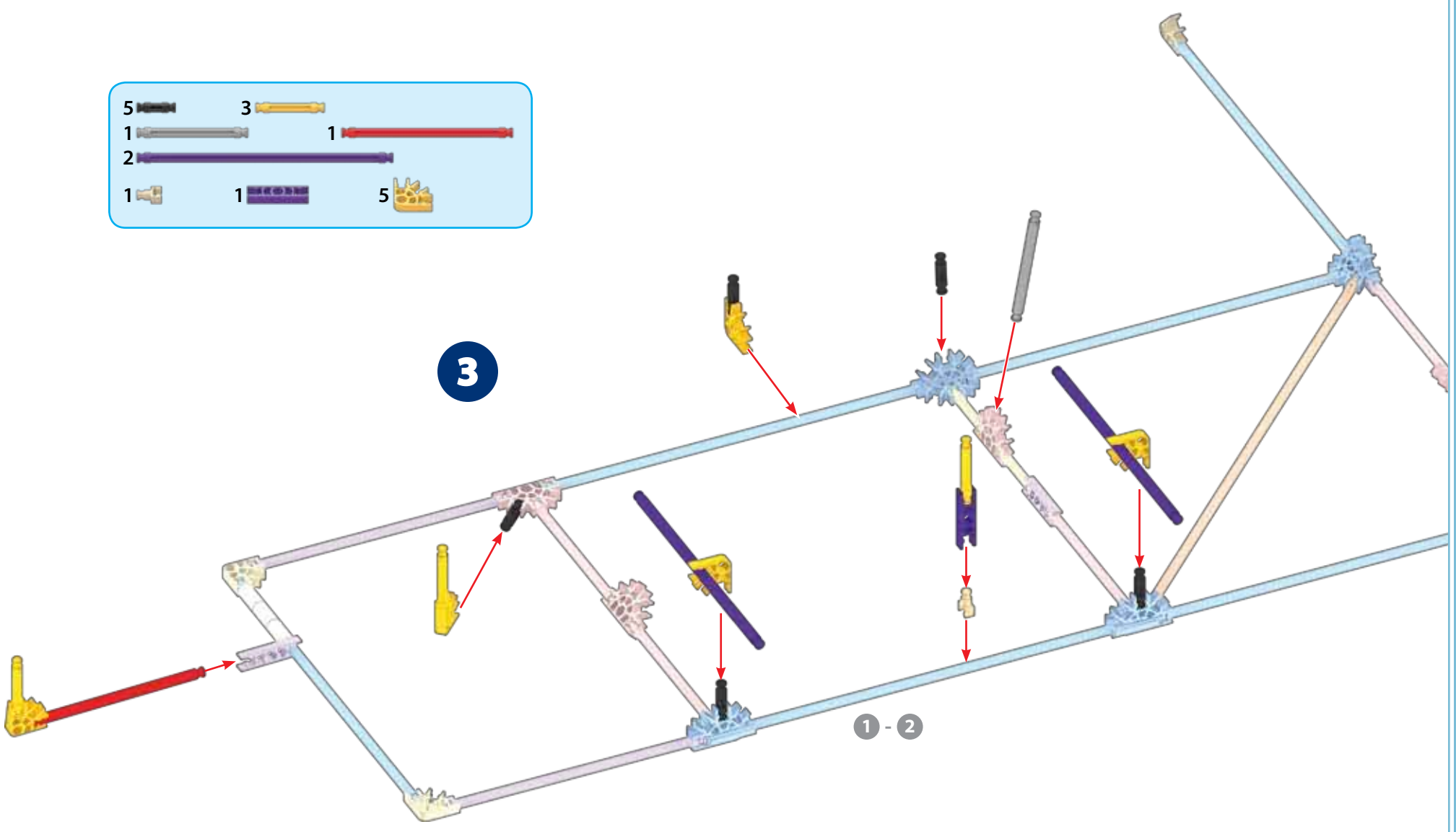

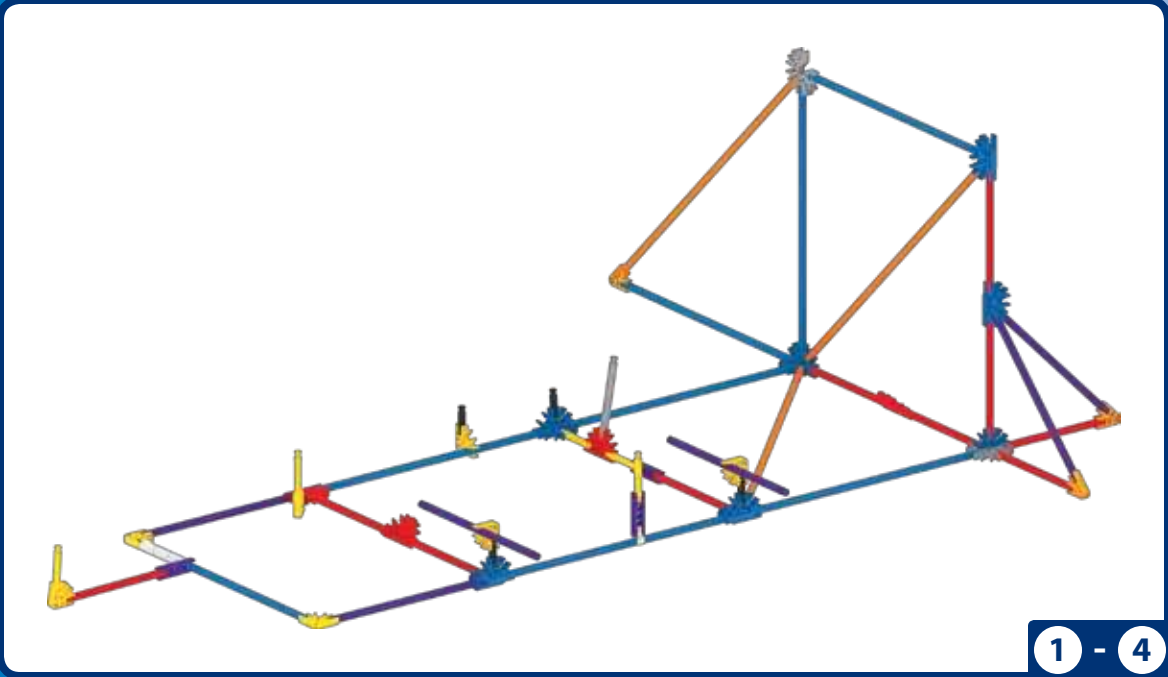

1 - 4

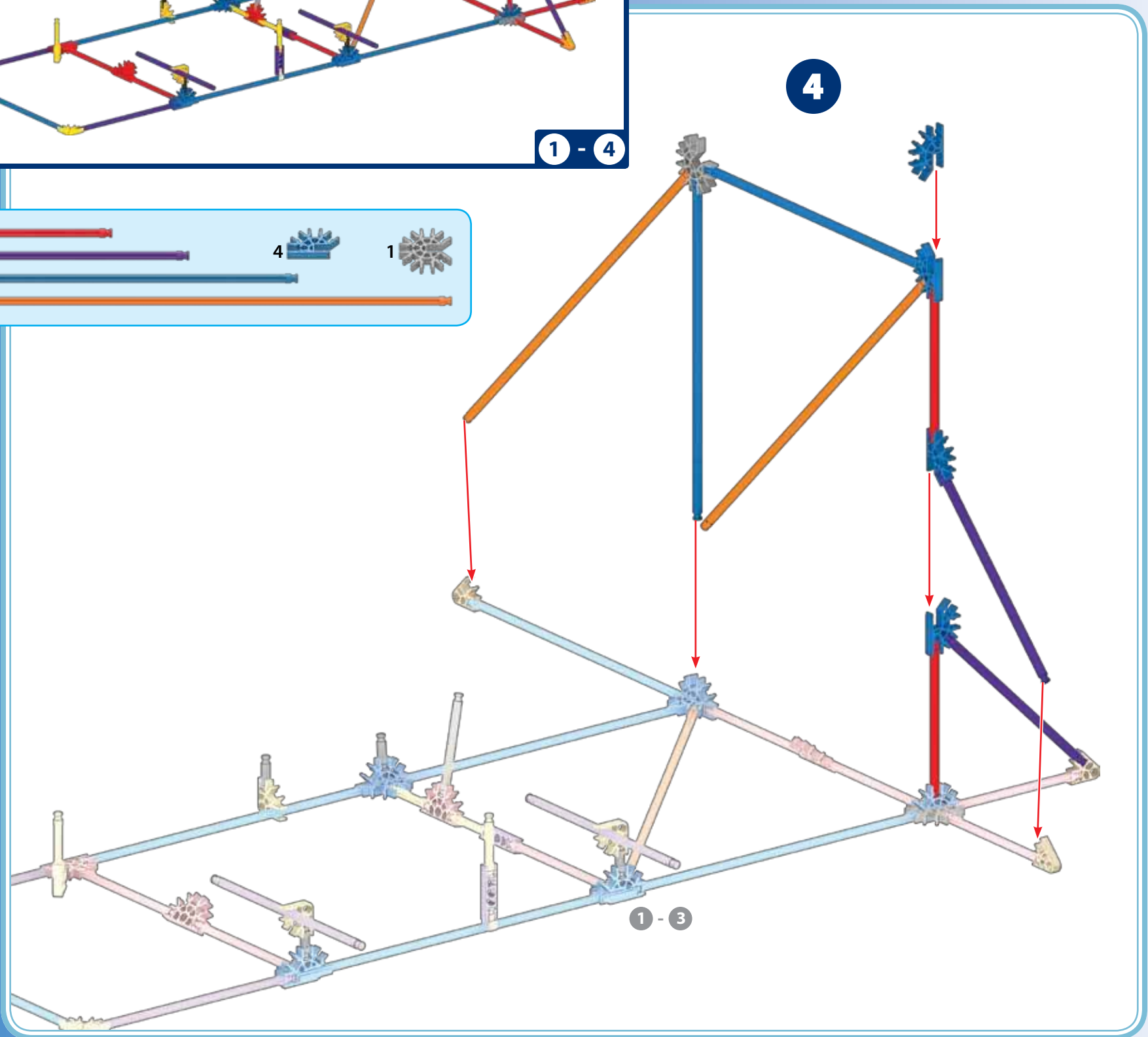
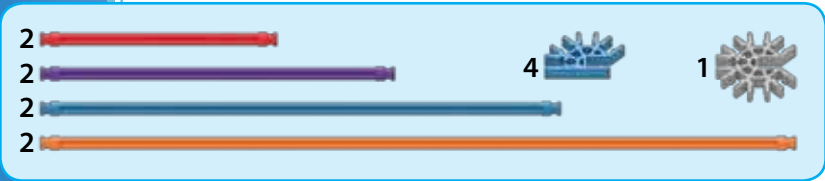

4

1 - 3

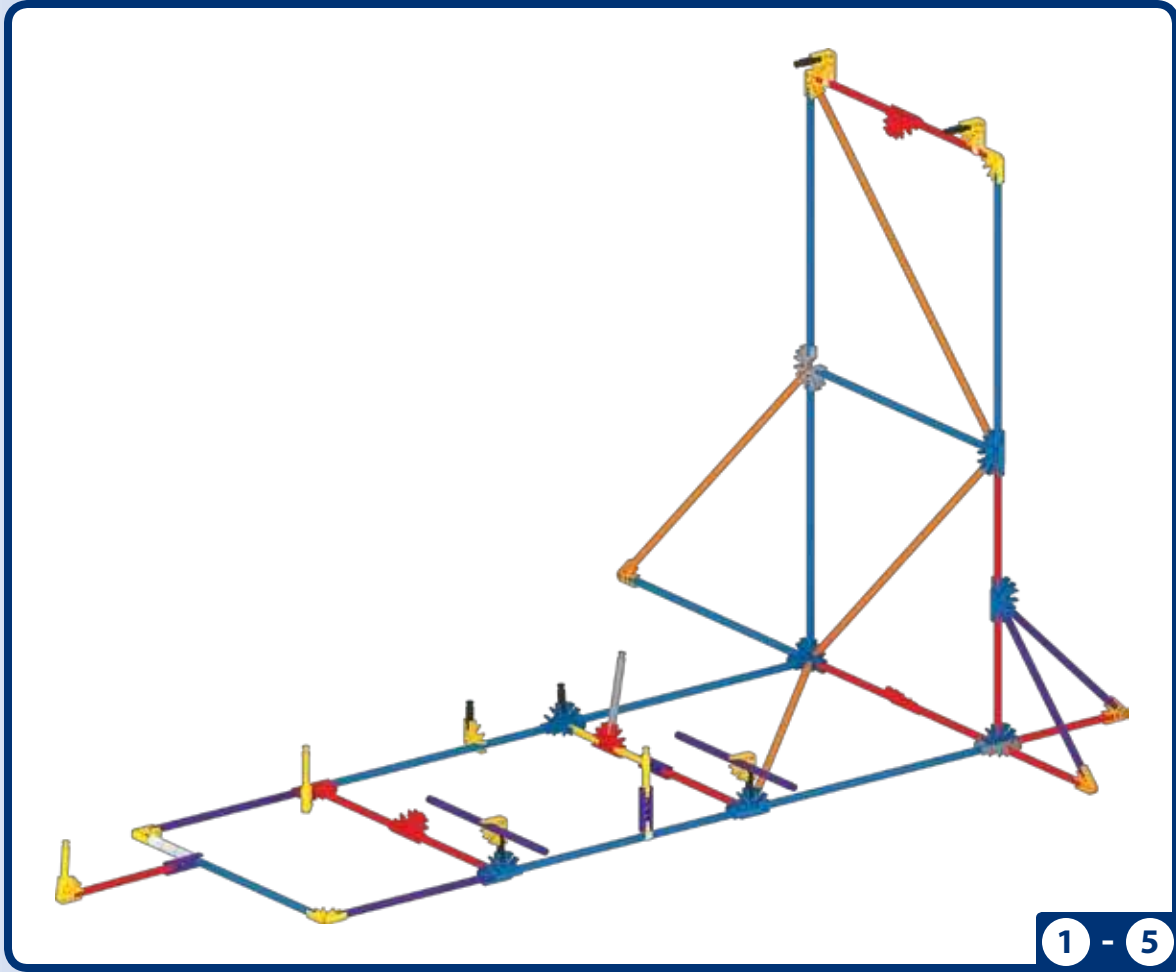

5

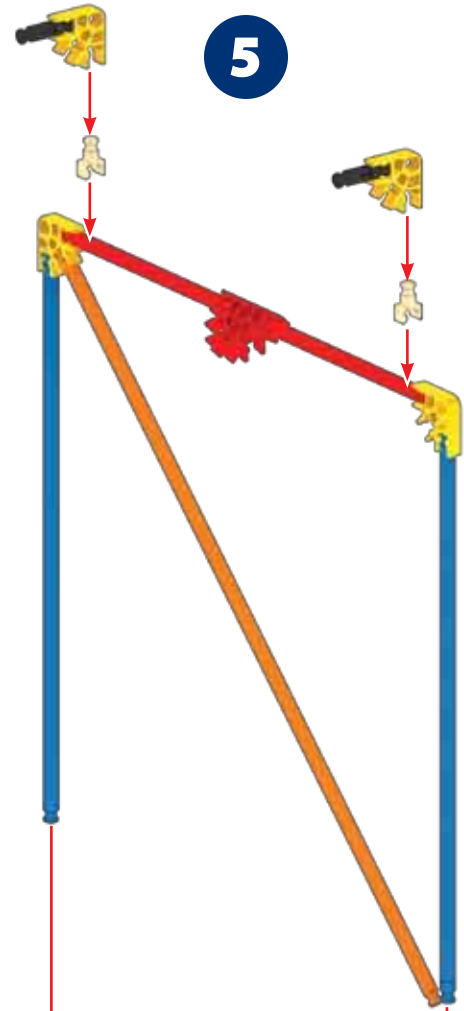
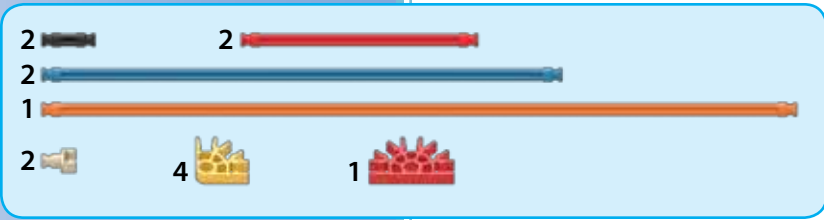

5

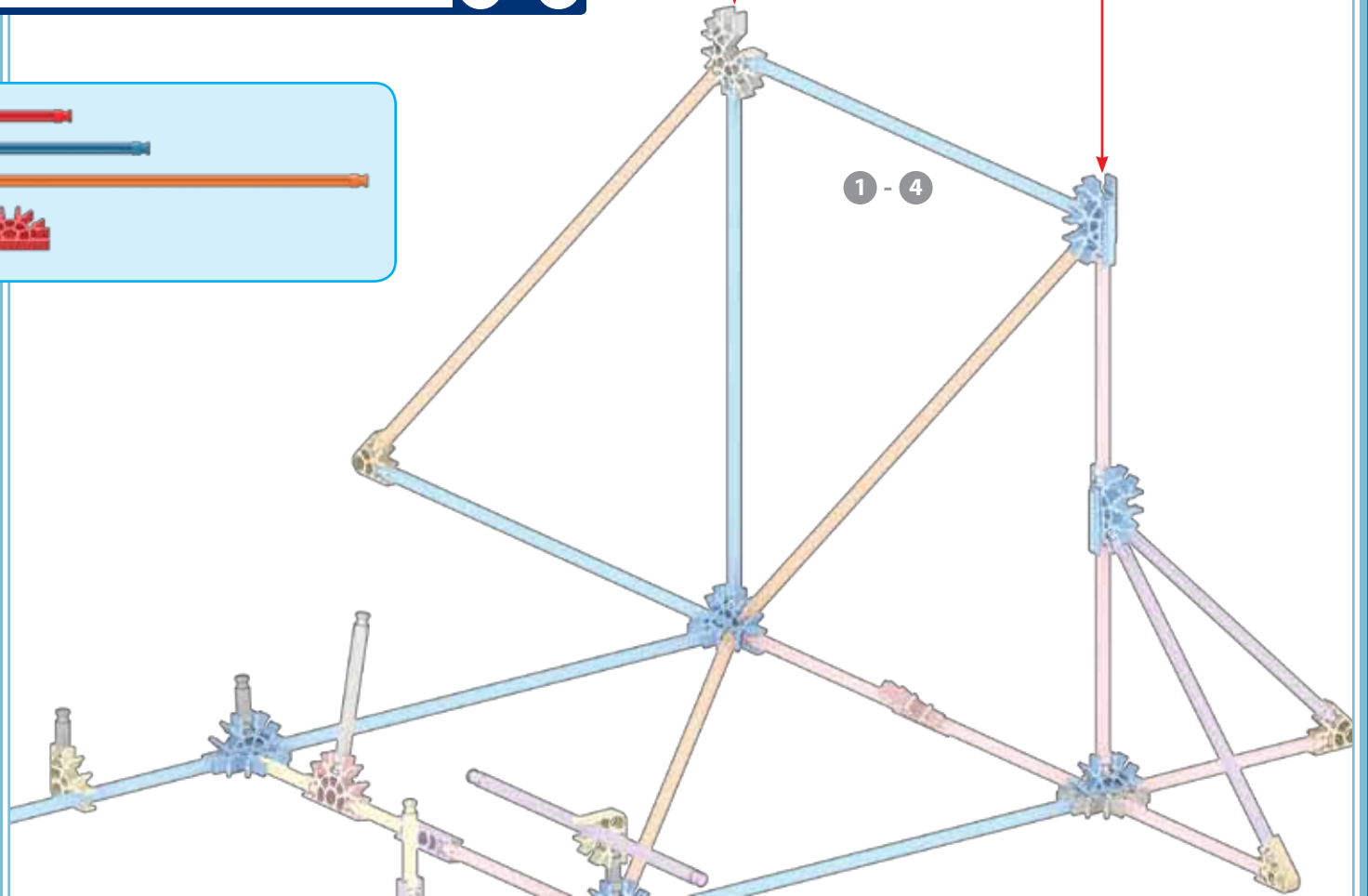

1 - 4

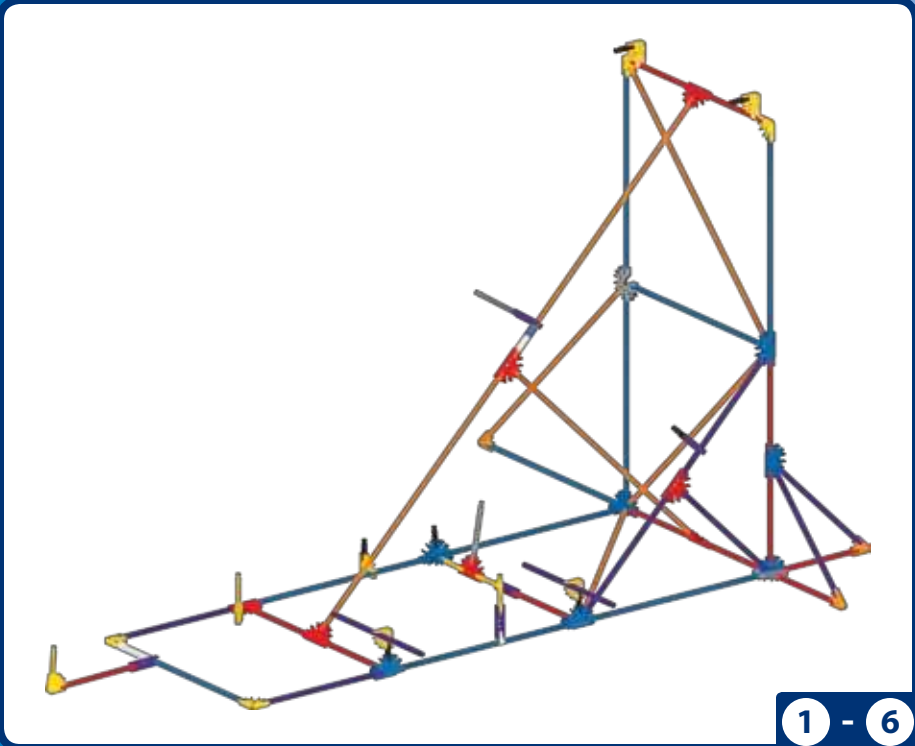

1 - 6



6

1 - 5

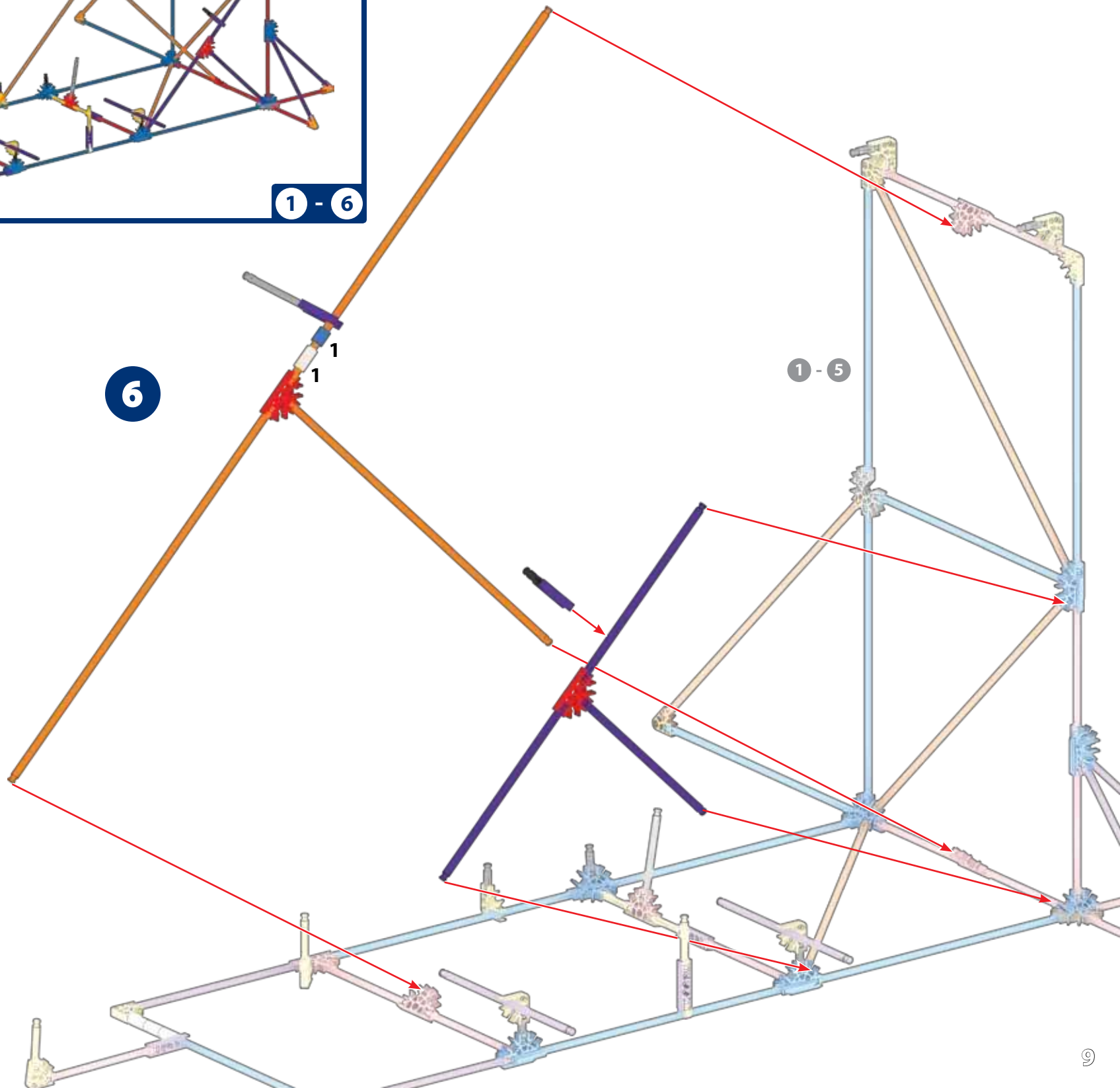

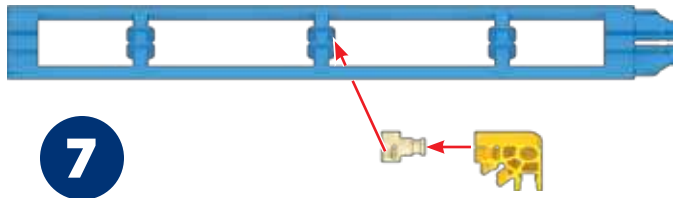

Be sure to push the connectors on firmly until they "click".
Pousse bien les connecteurs jusqu'à ce qu'ils « clizquent ».

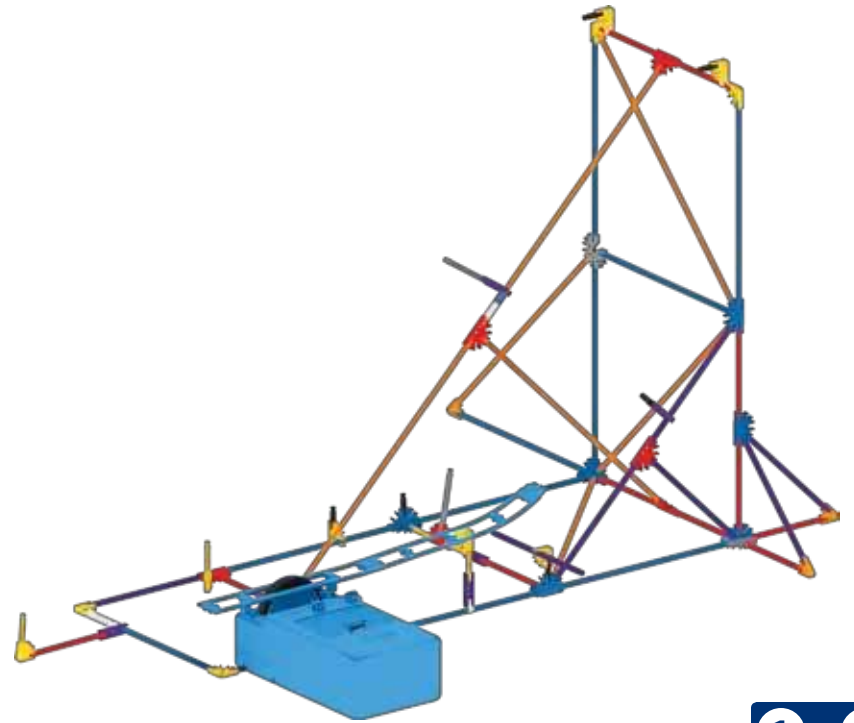

Did you install 3 AA (or LR6) batteries in the motor?
Avez-vous installé 3 piles AA (ou LR6) ?

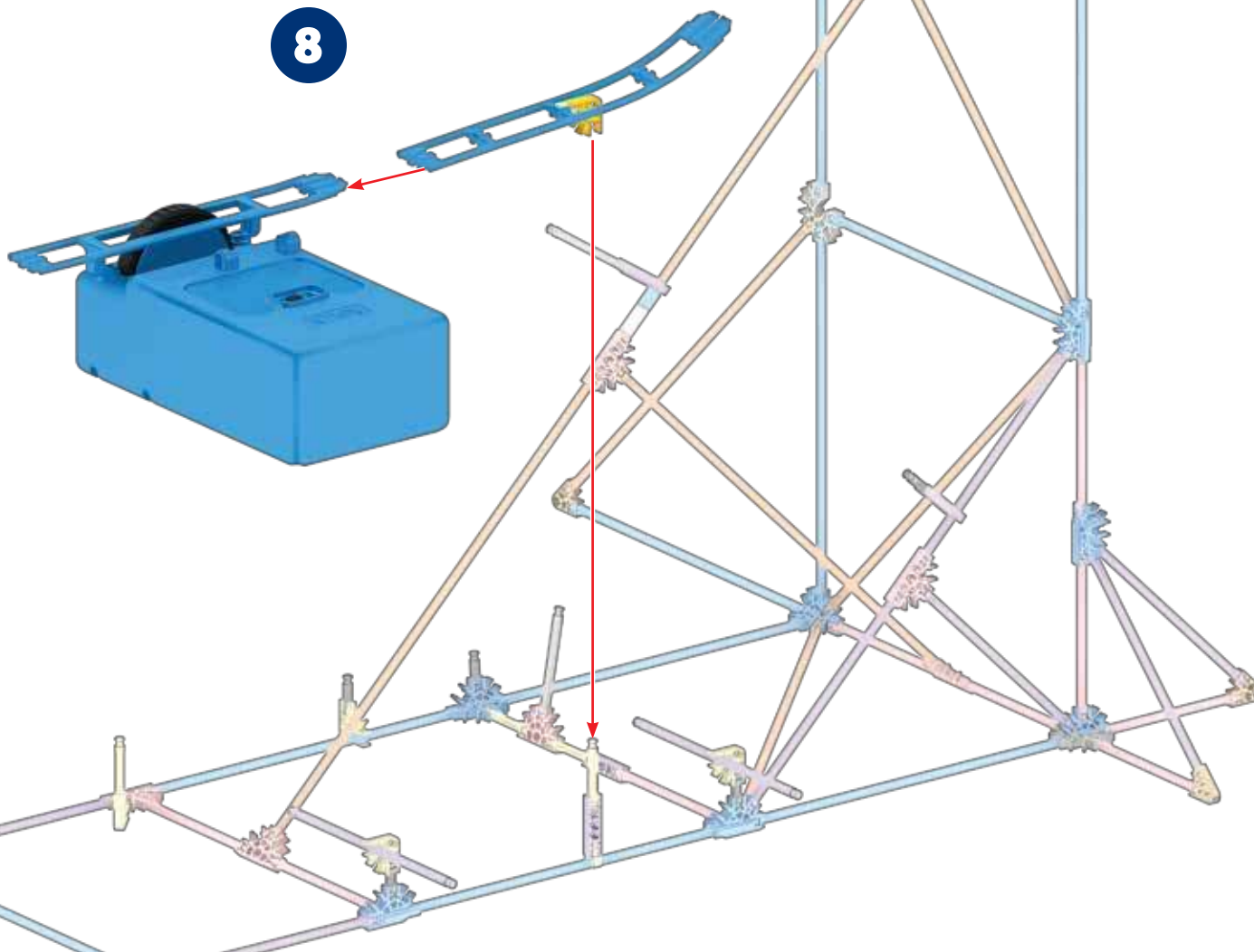



9



Always join this end of the track to the previous track piece first, then connect the rest of the track to the tower.

Toujours joindre à cette extrémité de la voie à la pièce de la piste précédente, puis connecter le reste de la piste à la tour.

10

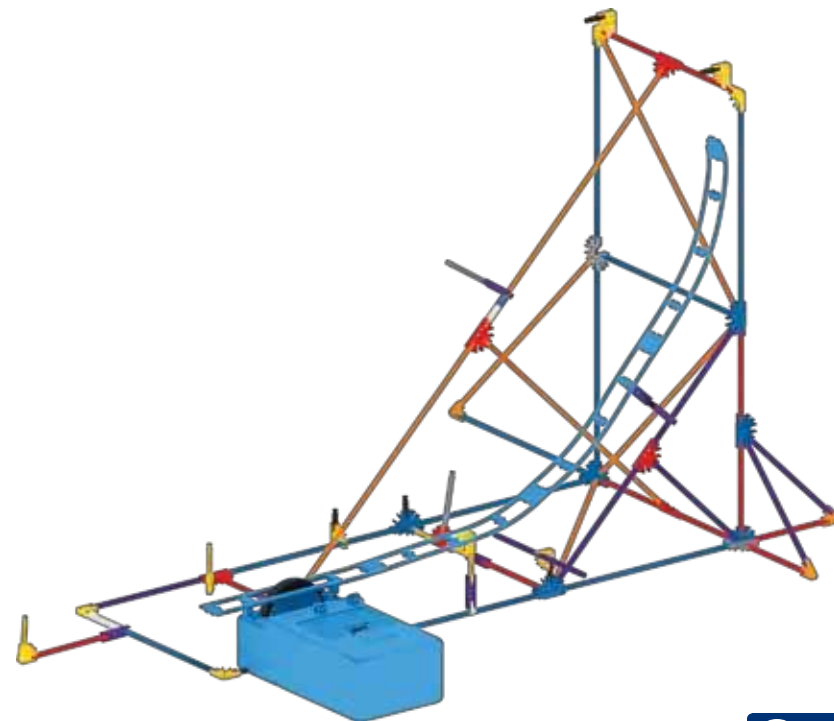
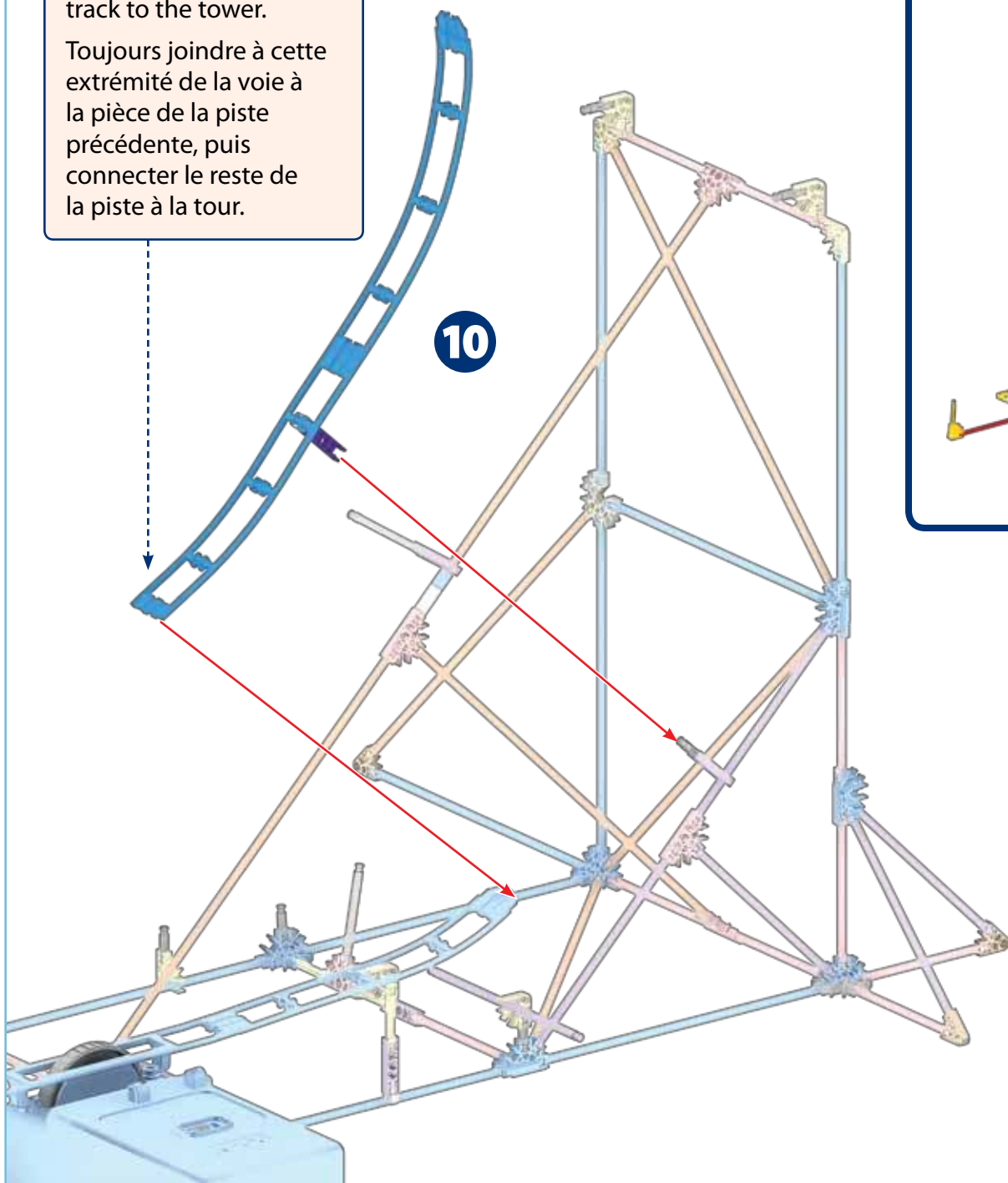

1 - 10

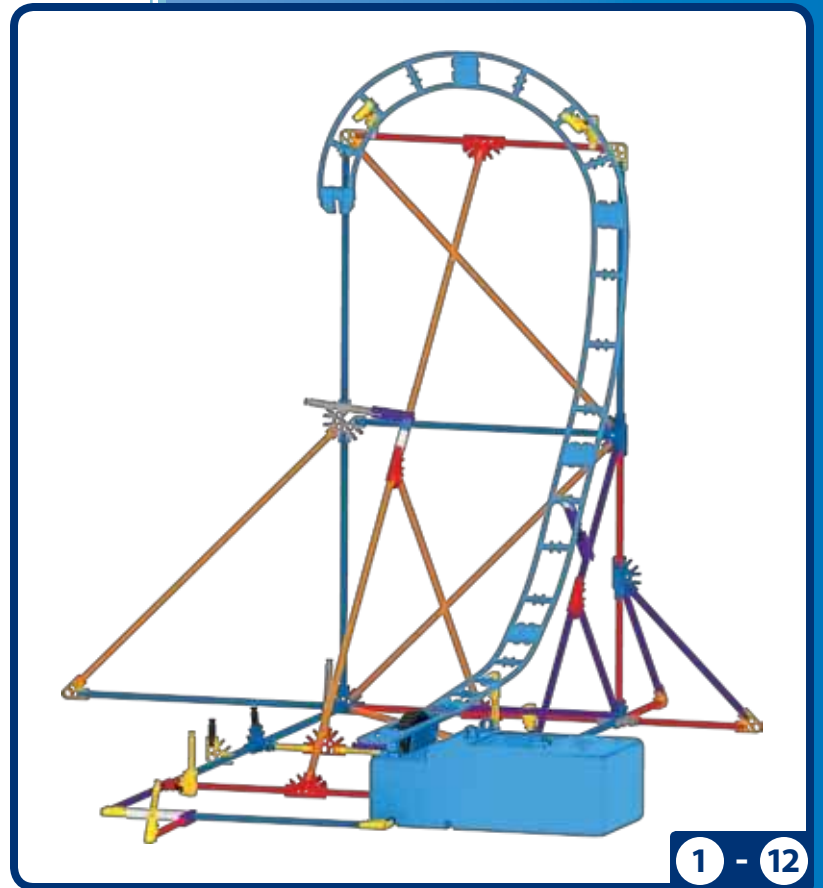
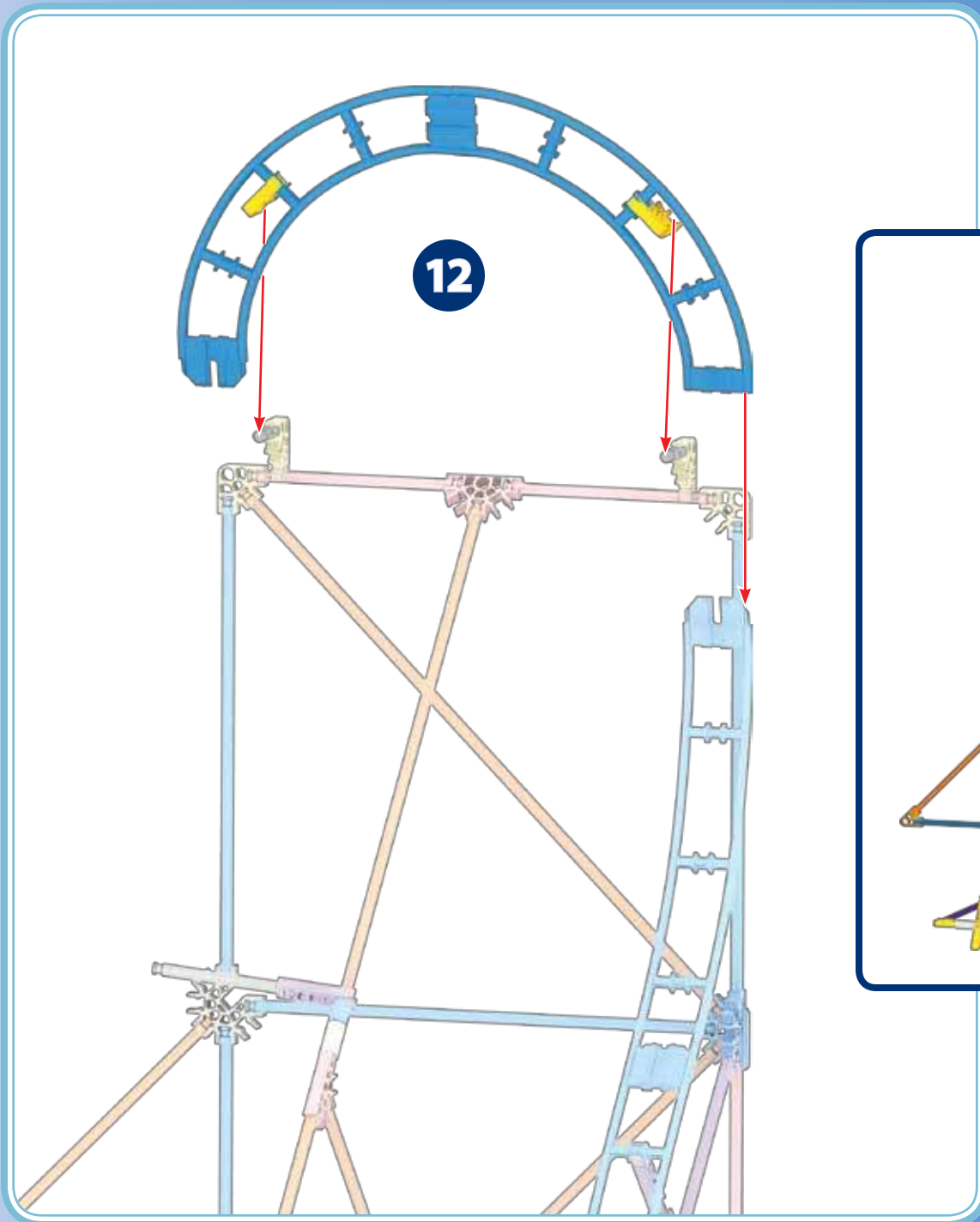
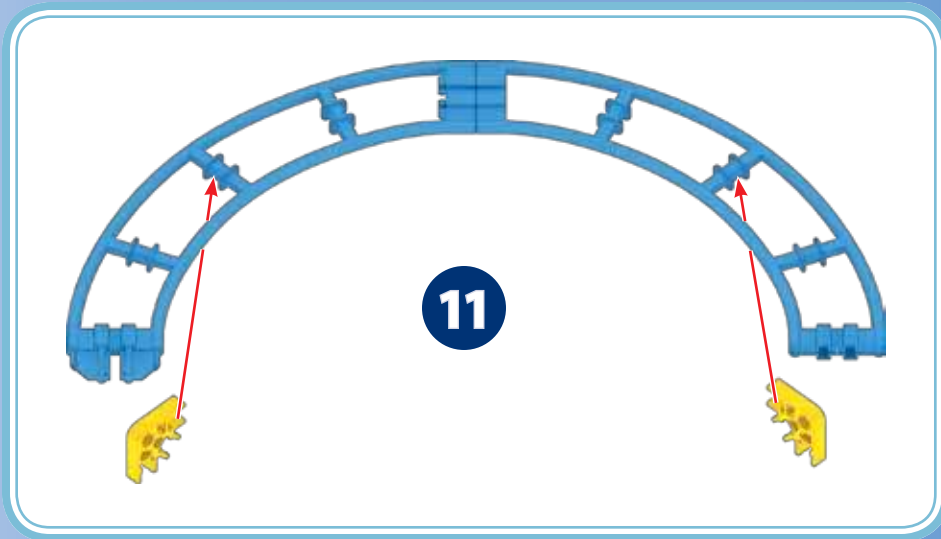

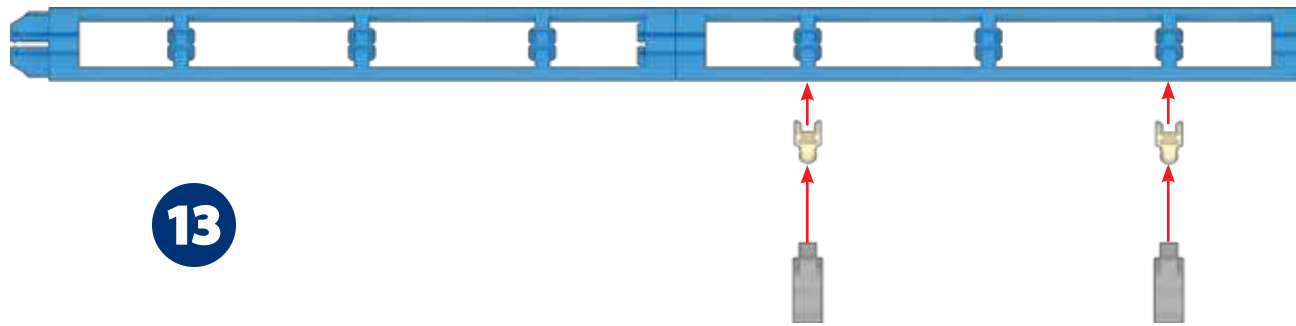

13

14

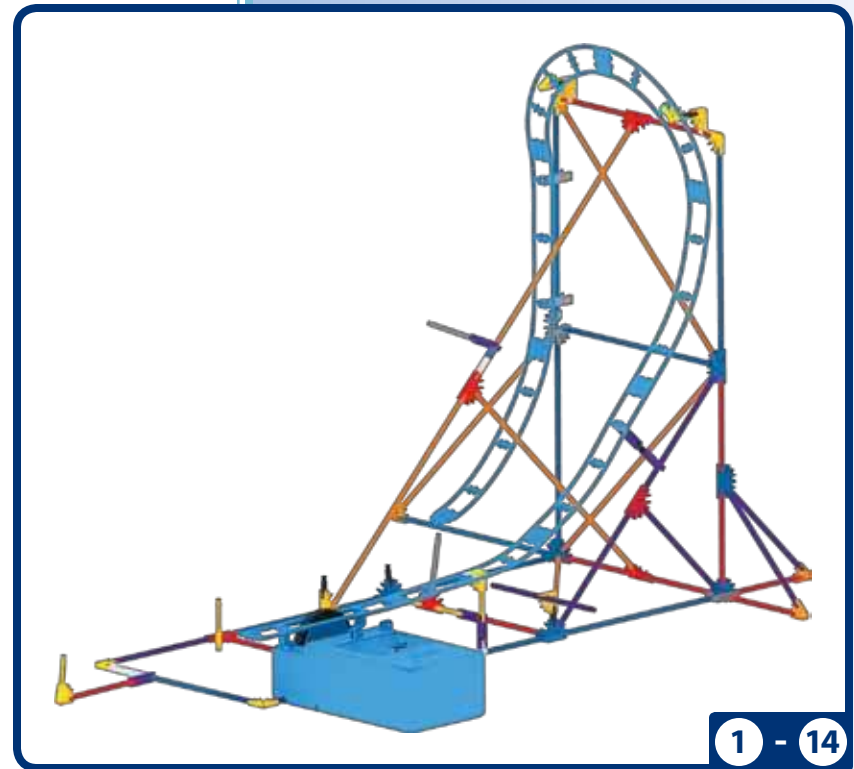
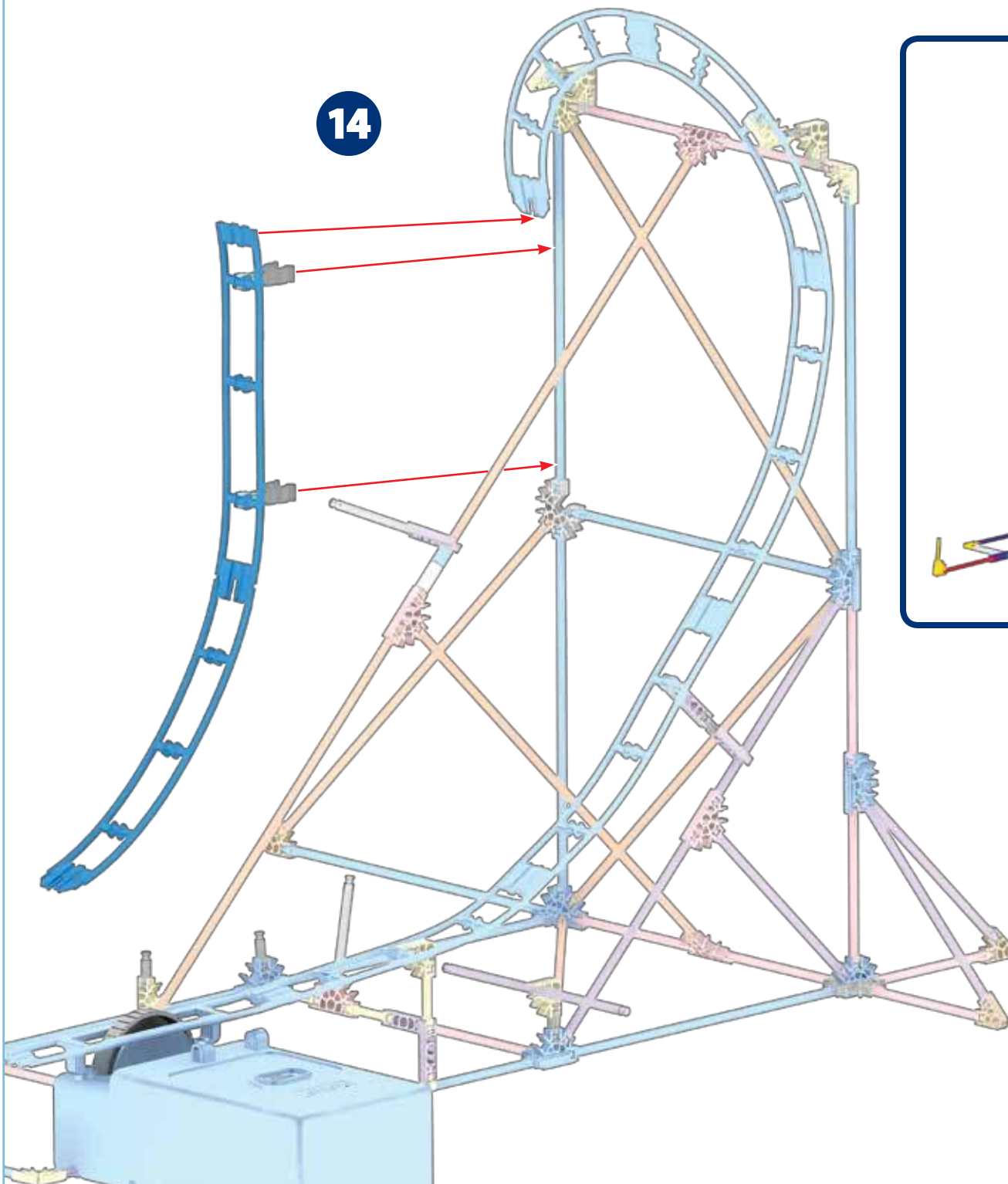

1 - 14

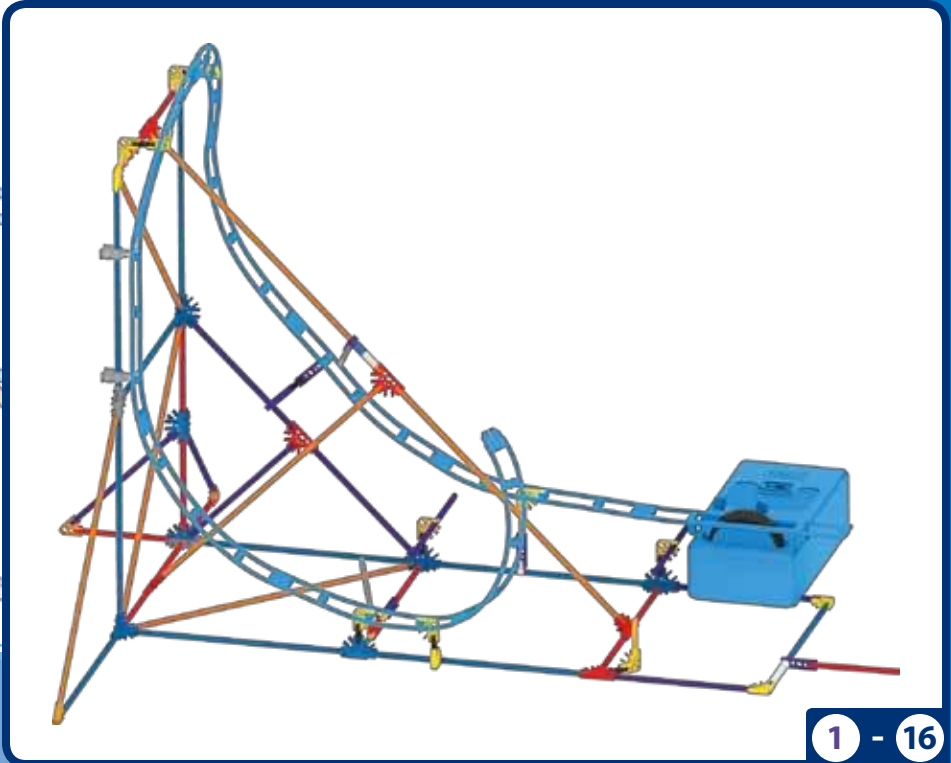
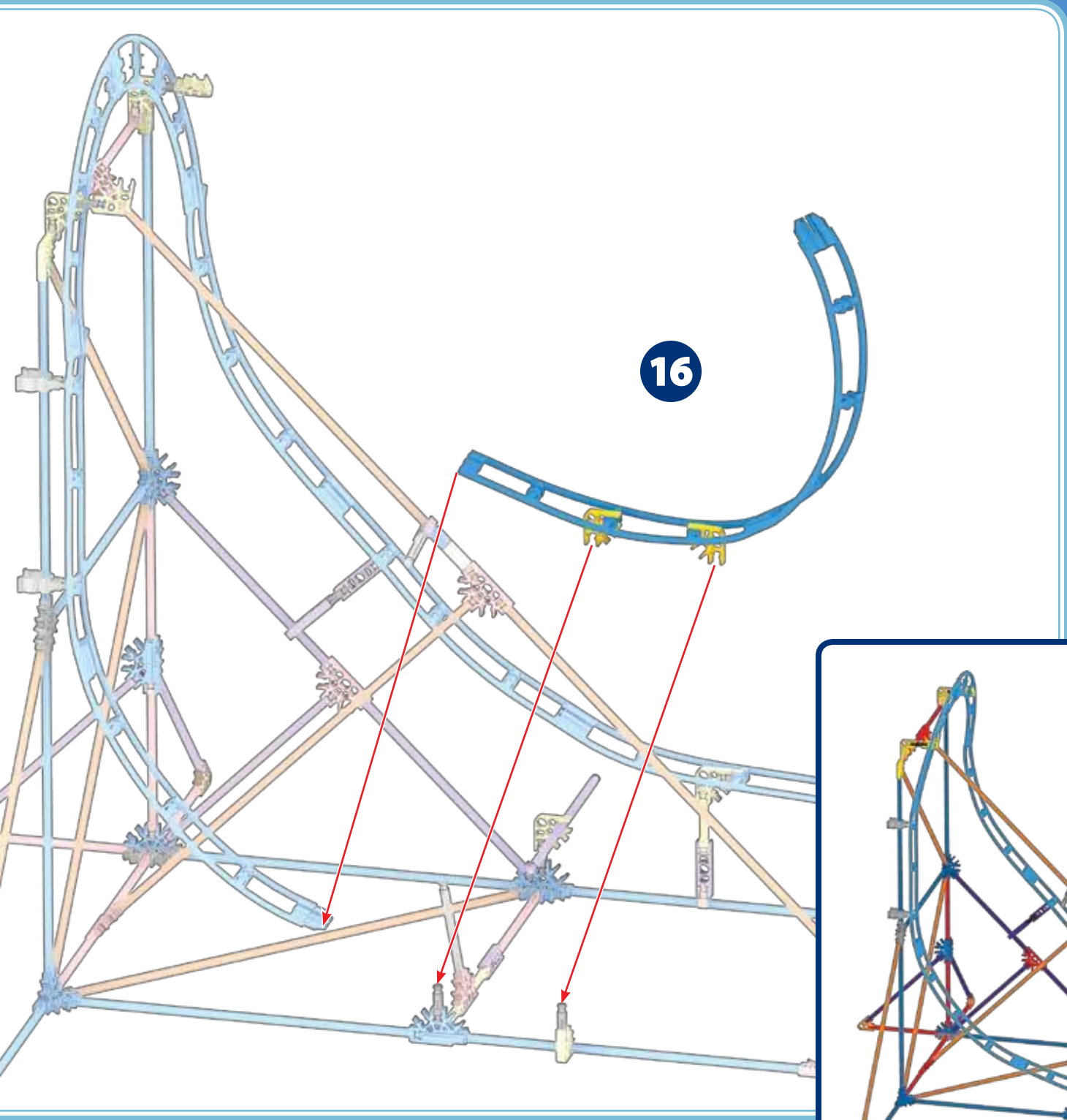
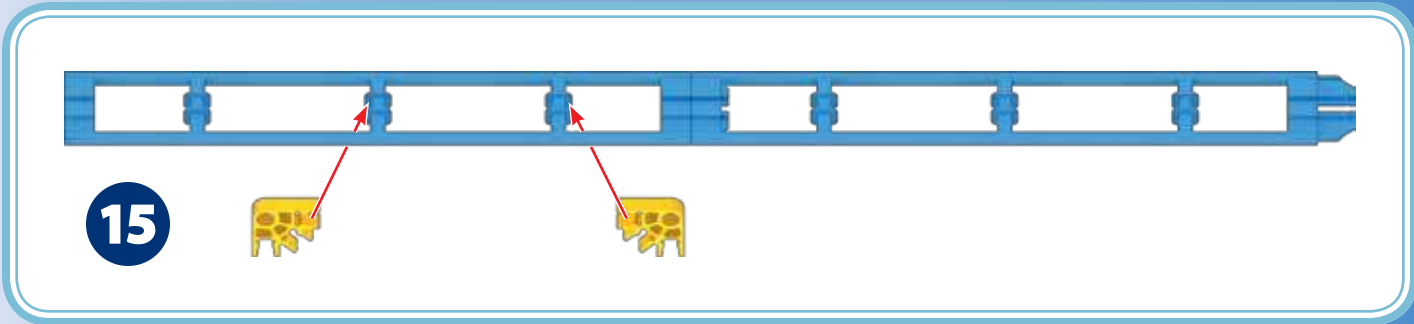

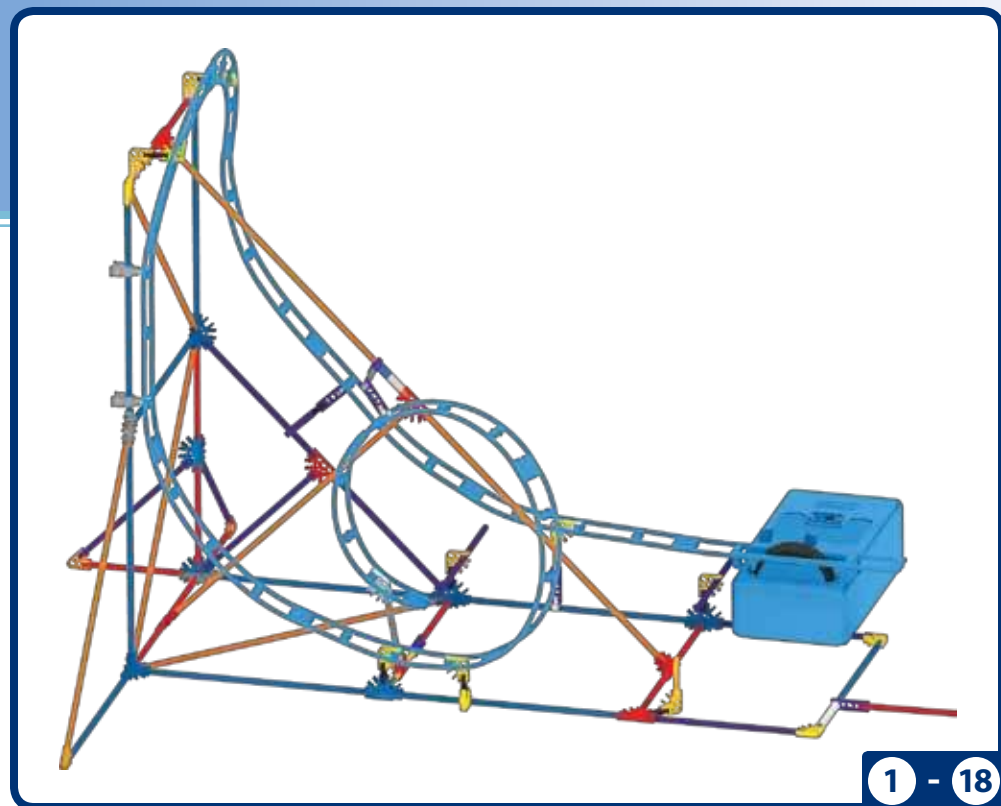
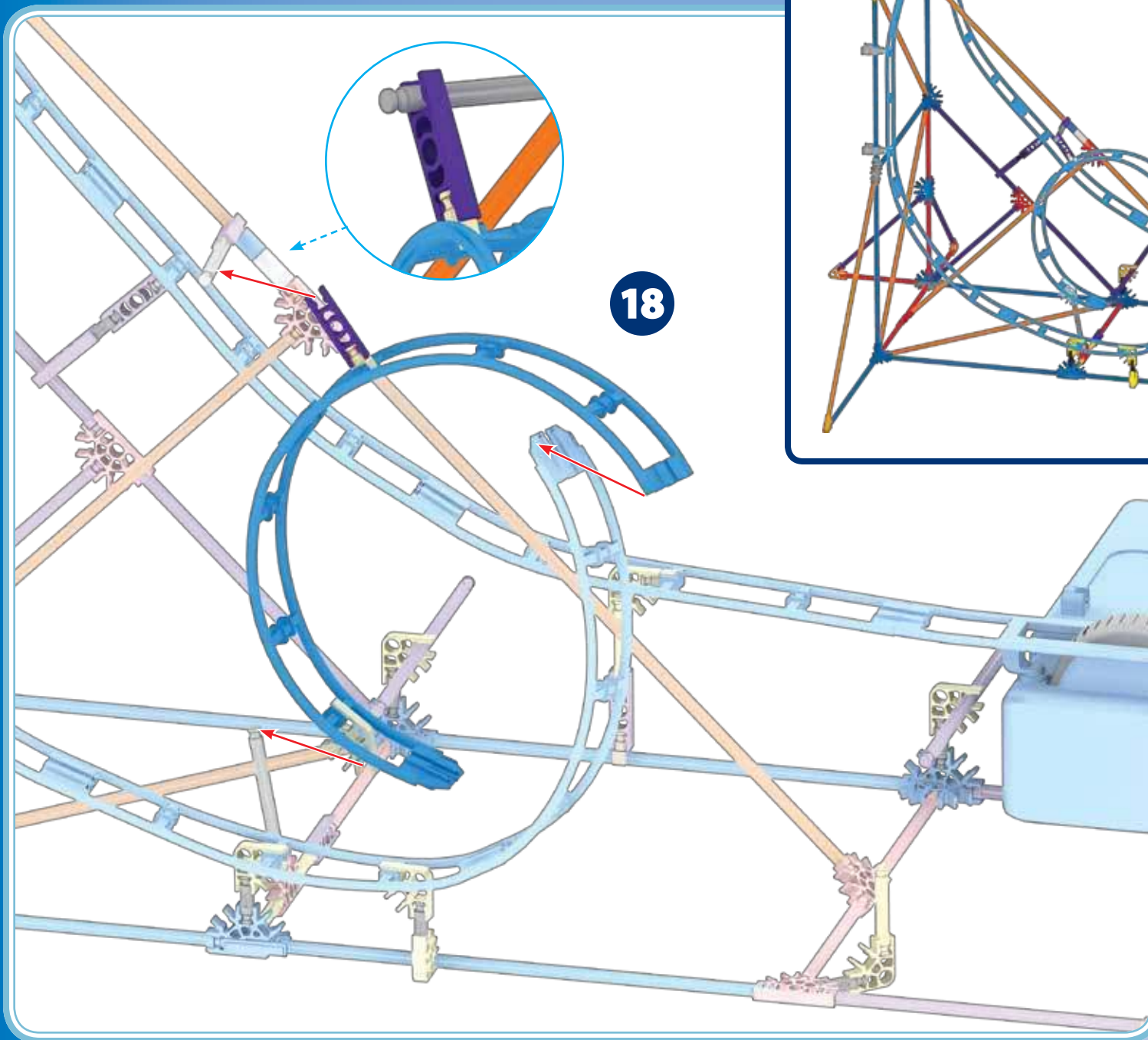
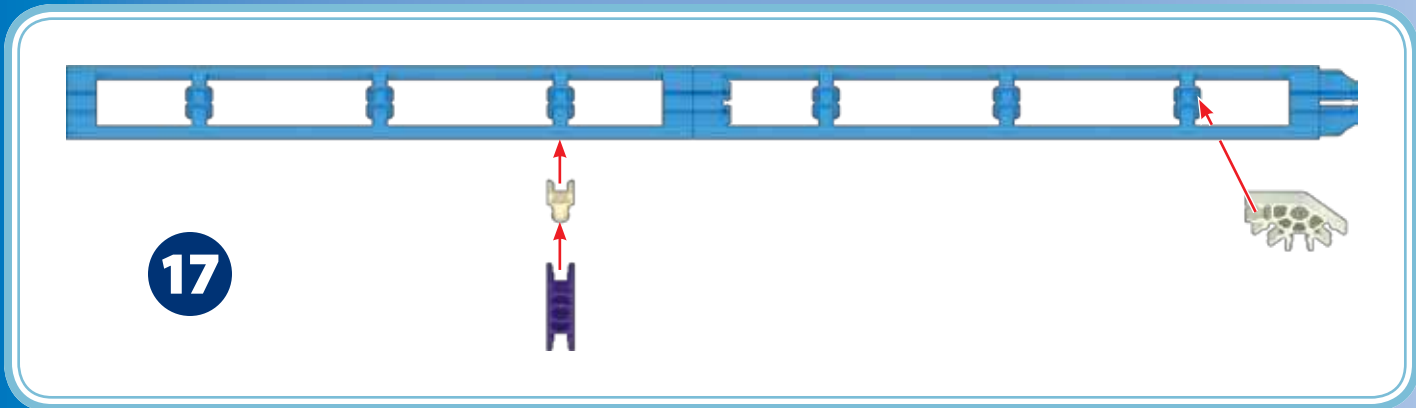

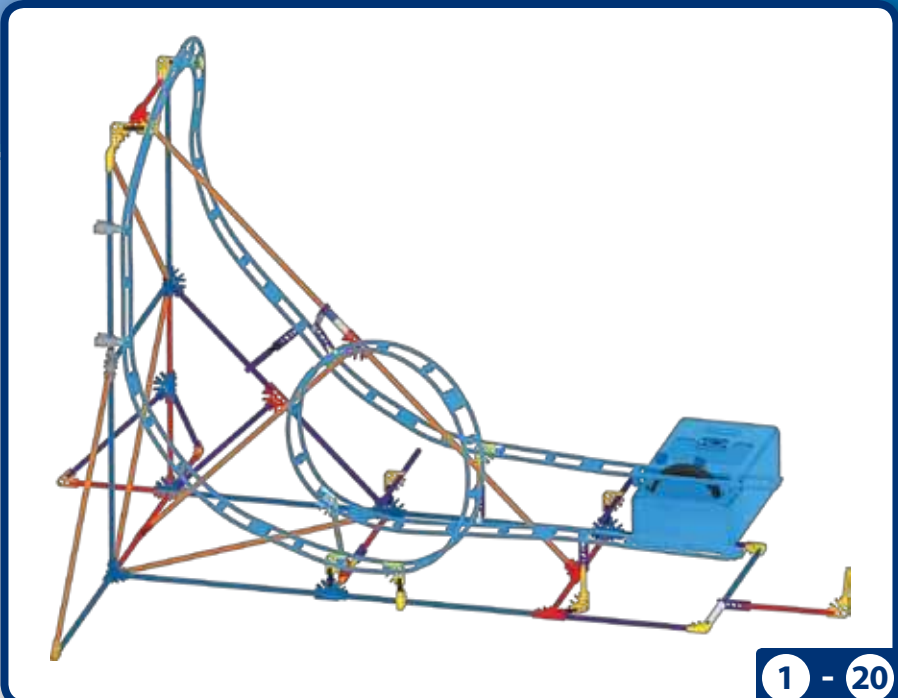
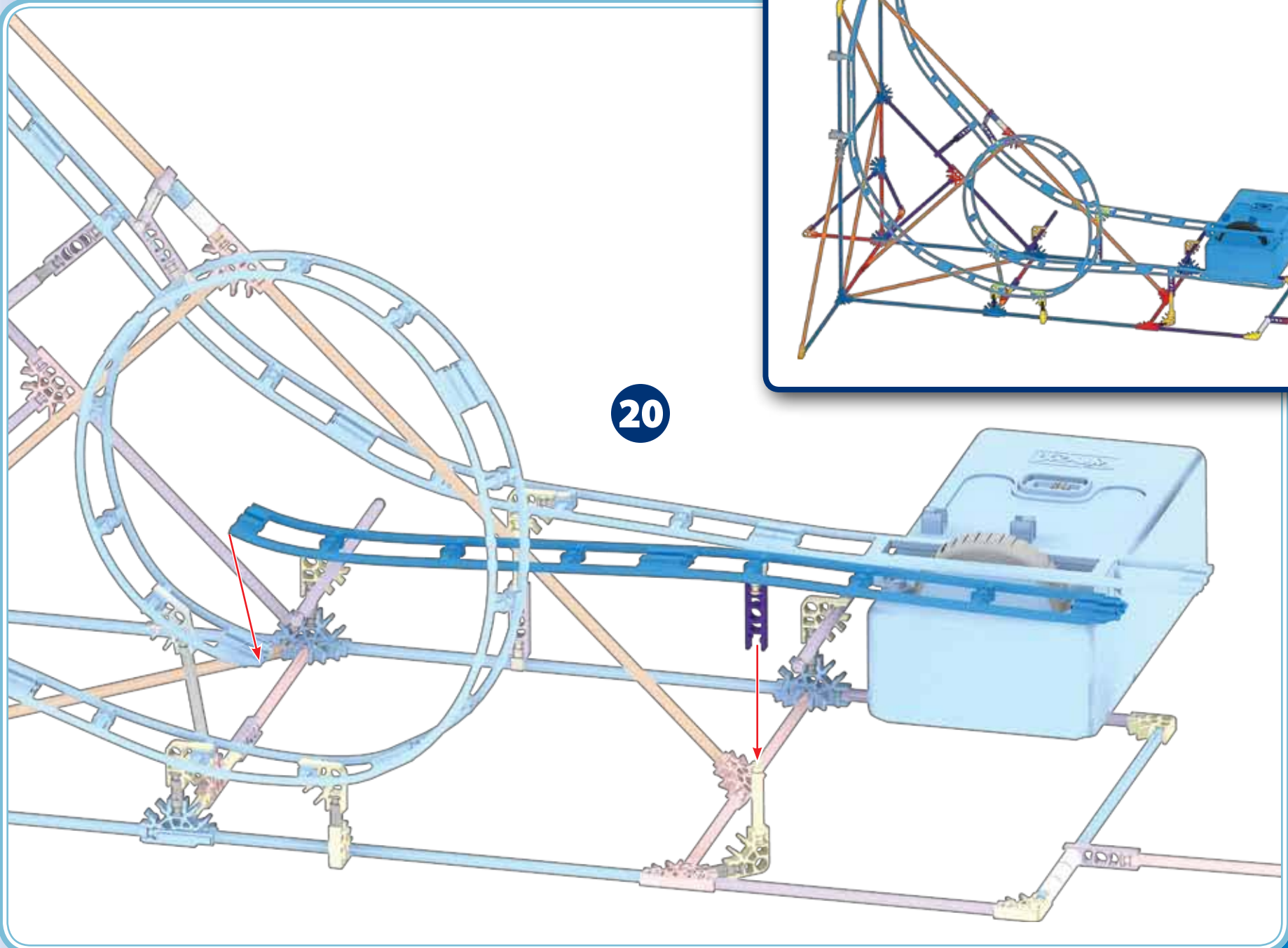
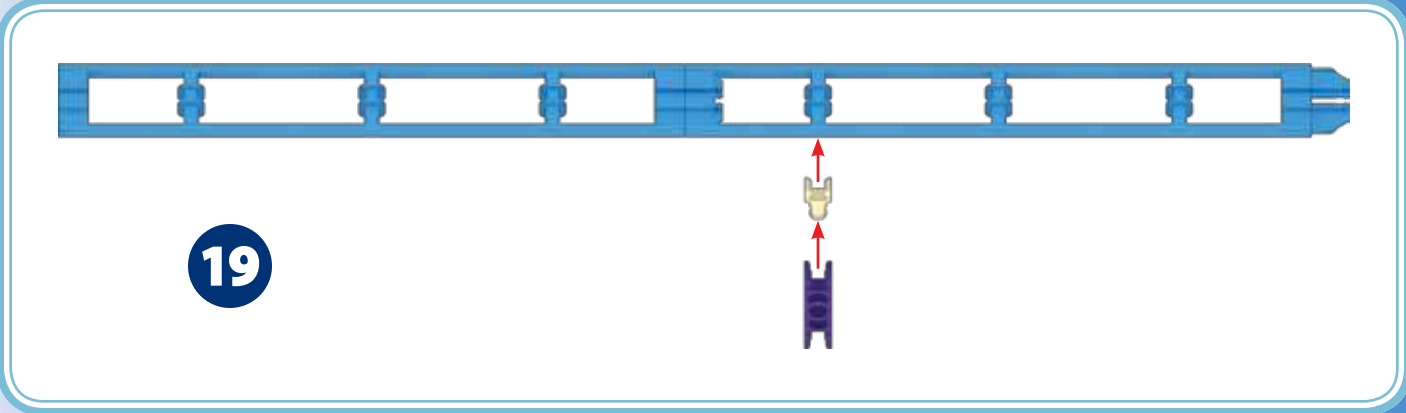

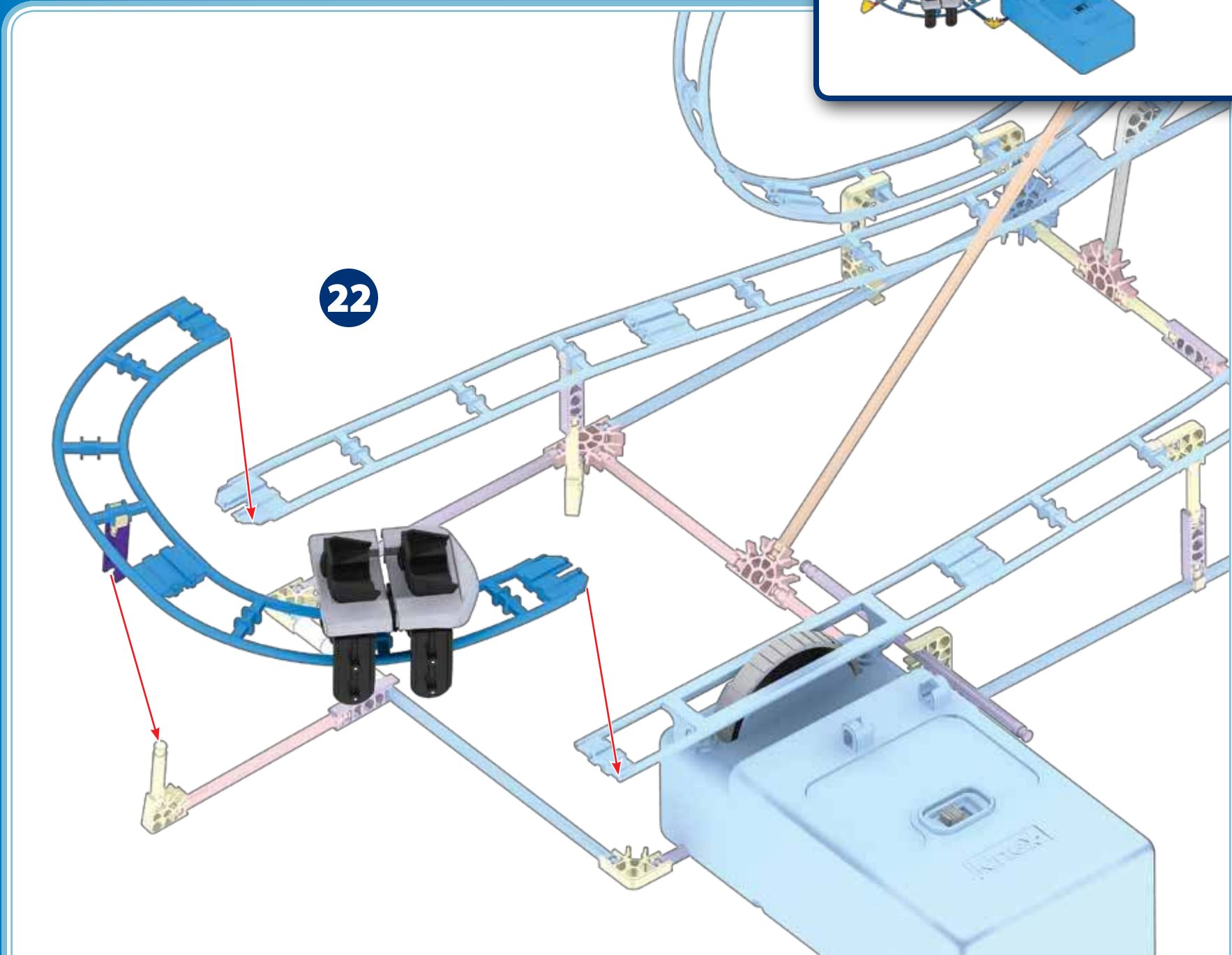
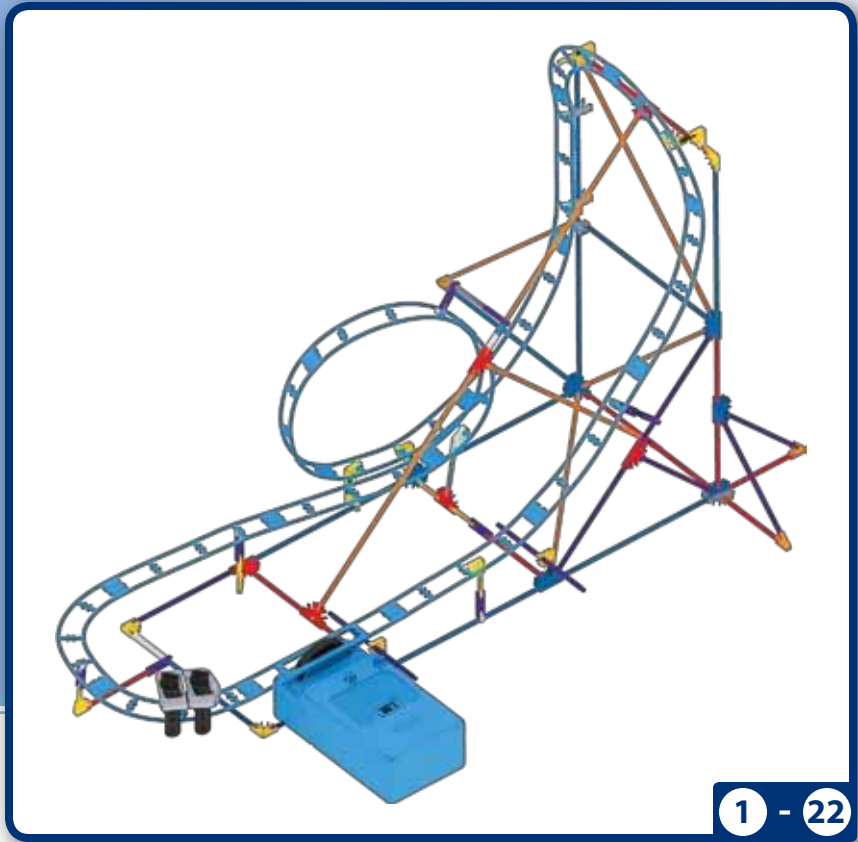
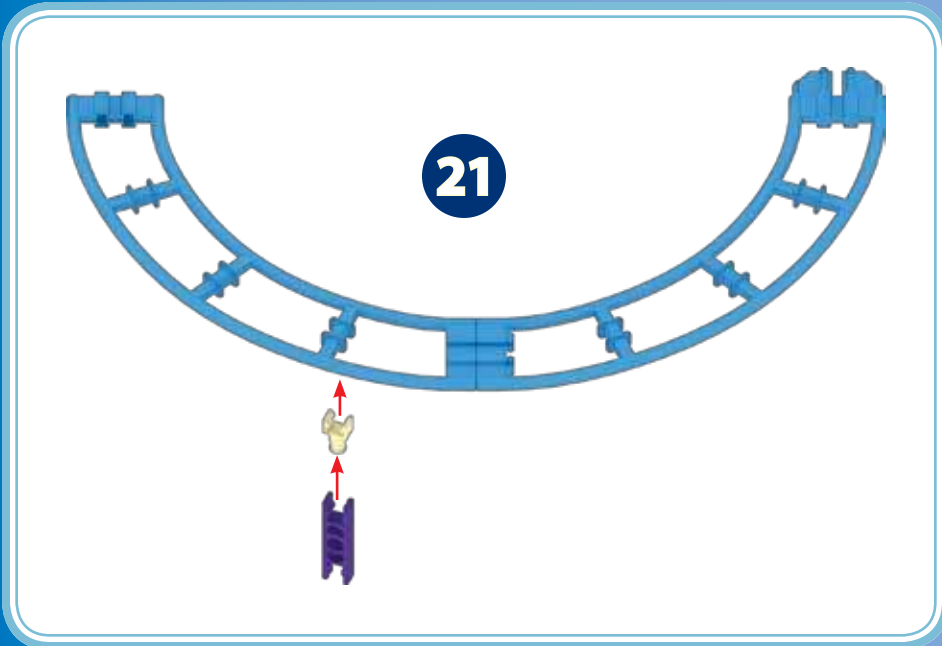

23

Fold Plier

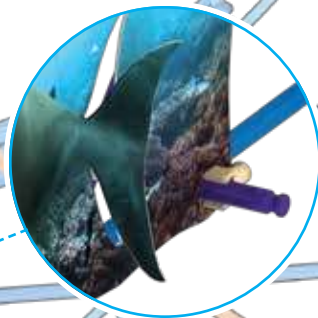
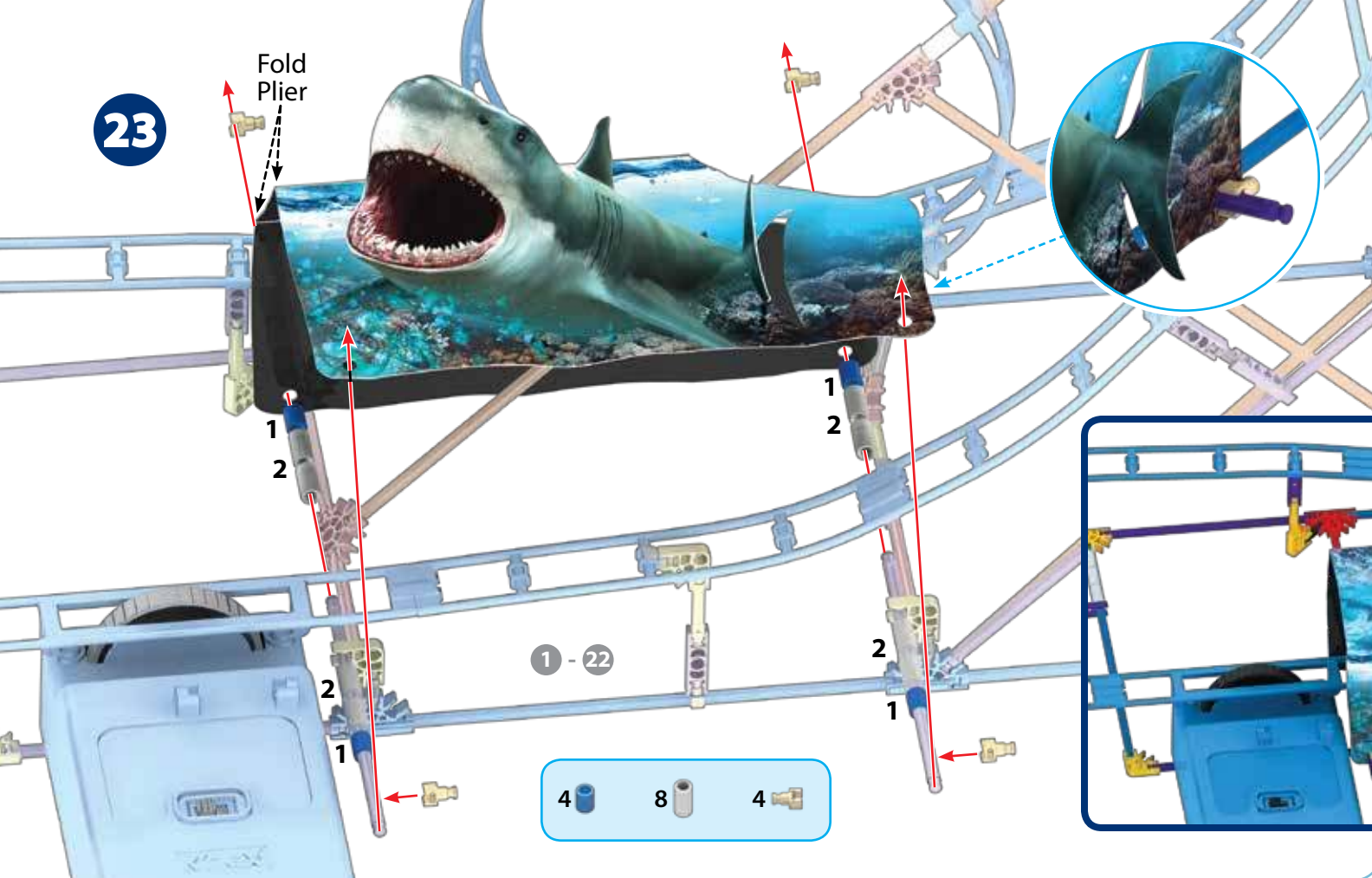

- 2
- 1
- 1
- 8
- 2
- 1
- 1

24

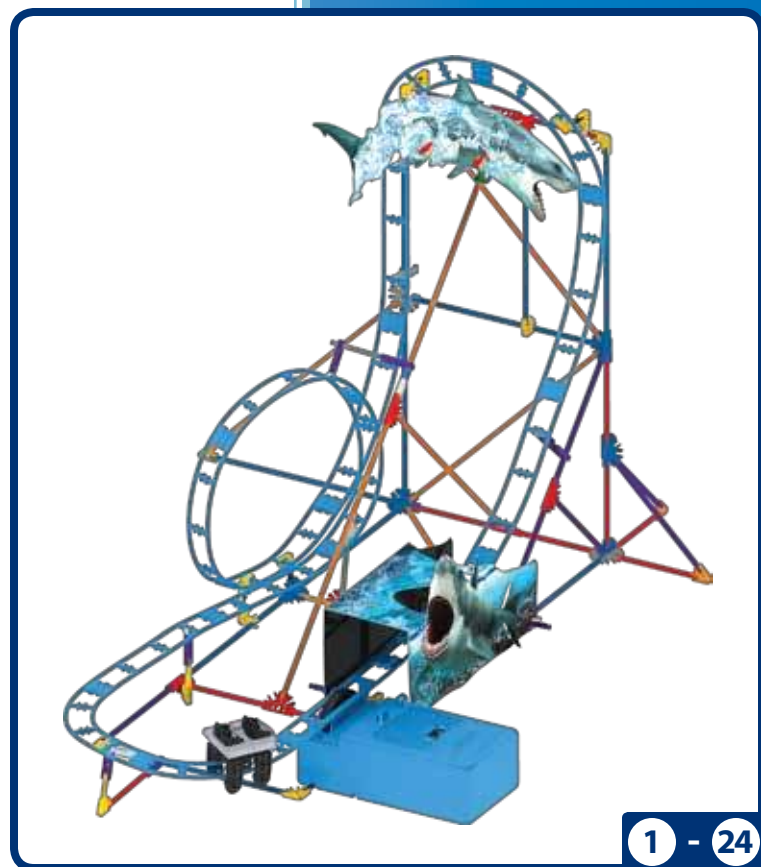
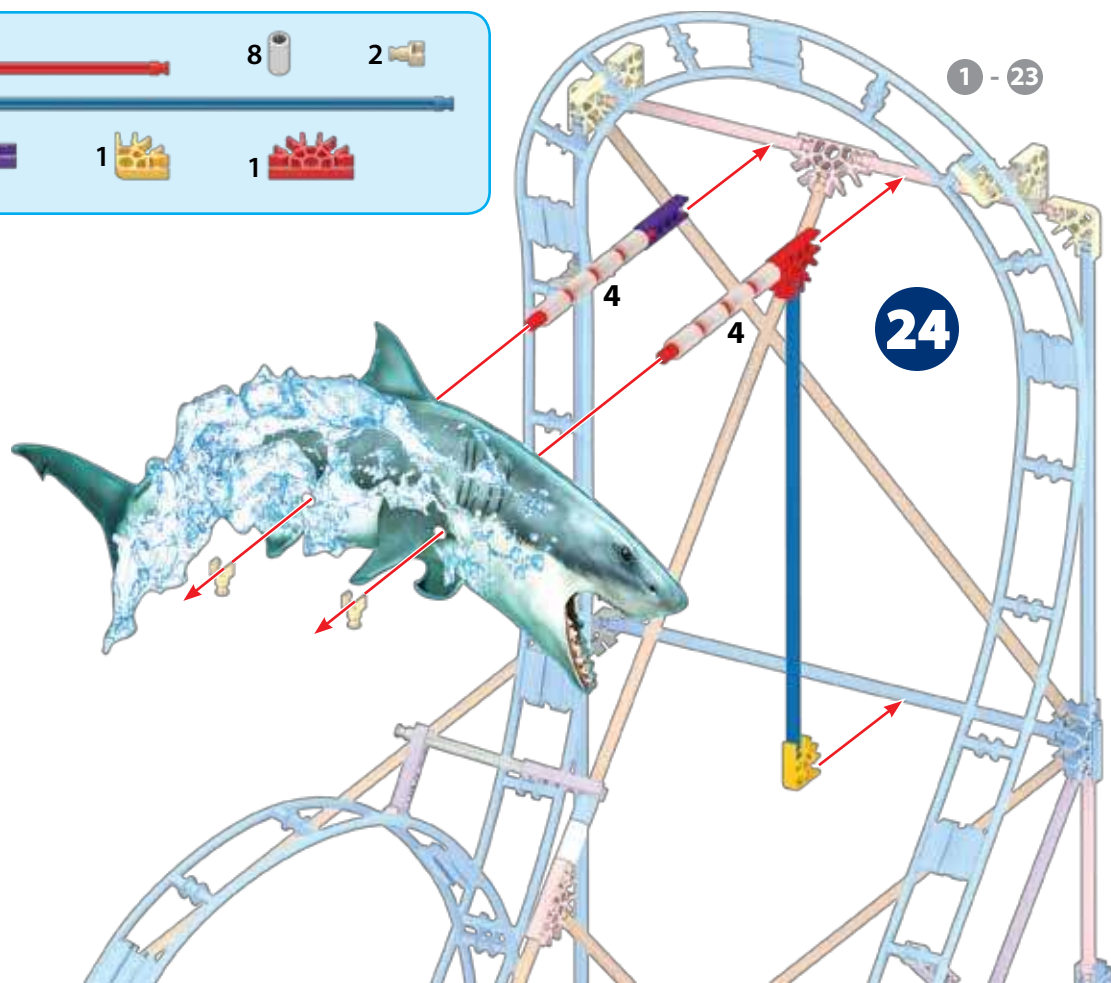

(EN) Parts List

If anything is missing, please visit www.Basicfun.com to contact us. We are here to help you!

(FR) Liste des Pièces

Si quelque chose manque, veuillez visiter www.Basicfun.com pour nous contacter. Nous sommes là pour vous aider !

(ES) Lista de Piezas

Si falta algo, visite www.Basicfun.com para contactarnos. ¡Estamos aquí para ayudarte!

(DE) Teileliste

Wenn etwas fehlt, besuchen Sie bitte www.Basicfun.com, um uns zu kontaktieren. Wir sind hier, um dir zu helfen!

(IT) Elenco delle parti

Se manca qualcosa, visitare www.Basicfun.com per contattarci. Siamo qui per aiutarvi!

(PT) Lista de peças

Se alguma coisa estiver faltando, por favor visite www.Basicfun.com para nos contatar. Estamos aqui para ajudá-lo!

(NL) Lijst met onderdelen

Als er iets ontbreekt, bezoek dan www.Basicfun.com omcontact met ons op te nemen. We zijn er om u te helpen!

