



## **FCS-4201\_4301\_4202\_4302**

PT/ Zoom Dome Network Camera  
2-Megapixel, , PoE 802.3af, Day & Night,  
IR LEDs, WDR, 3DNR

---

## **User's manual**

Version 0.8

# Table of Contents

|                                                   |    |
|---------------------------------------------------|----|
| <i>Package Contents</i> .....                     | 5  |
| <i>Connections</i> .....                          | 6  |
| Hardware description_Indoor_FCS-4201_4301.....    | 6  |
| <i>Slide cover</i> .....                          | 6  |
| <i>Wired cover</i> .....                          | 6  |
| Hardware description_Indoor_FCS-4202_4302.....    | 7  |
| <i>Connect to the Network Camera</i> .....        | 13 |
| Install the IP Finder program.....                | 13 |
| Bonjour program.....                              | 19 |
| C2.mylevel1.com(Free DDNS service).....           | 20 |
| <i>Initial Access to the Network Camera</i> ..... | 21 |
| <i>Primary user's capability</i> .....            | 23 |
| Main Screen with Camera View.....                 | 23 |
| Client Setting.....                               | 28 |
| <i>Definitions in Configuration</i> .....         | 30 |
| <i>System parameters</i> .....                    | 30 |
| <i>Security</i> .....                             | 32 |
| <i>Network</i> .....                              | 34 |
| <i>Access list</i> .....                          | 37 |
| <i>Audio and Video setting</i> .....              | 40 |
| <i>Video record</i> .....                         | 44 |

*Stream* ..... 46  
*Camera control*(PTZ model only) ..... 48  
*Application* ..... 50  
*Storage* ..... 53  
*Syslog* ..... 55  
*Status and Parameters* ..... 56  
*Maintenance* ..... 57  
*Appendix*..... 59  
    A. Troubleshooting & Frequently Asked Questions ..... 59  
    B. Technical specifications ..... 65  
    C. Notification of Compliance..... 66

### Default Settings

|                   |      |
|-------------------|------|
| <b>IP Address</b> | DHCP |
| <b>Username</b>   | root |
| <b>Password</b>   |      |

## Overview

Law in your country may prohibit the use of surveillance devices. The Network Camera is not only a high-performance web-ready camera but also can be part of a flexible surveillance system. It is the user's responsibility to ensure that the operation of such devices is legal before installing this unit for its intended use.

It is important to first verify that all contents received are complete according to the list in the "Package Contents" chapter. Take notice of the warnings in "Quick installation guide" before the Network Camera is installed, then carefully read and follow the instructions in the "Installation" chapter to avoid damages due to faulty assembly and installation. This also ensures the product is used properly as intended.

The Network Camera is accessible via the LAN or Internet connection. Connect your Network Camera directly to a computer network or DSL modem, and with a standard Web browser you get instant, on demand video streams. Within minutes you can set up the Network Camera to capture a video sequence to a PC. Live video image can be uploaded to a website for the world to see or made available only to select users on the network.

The Network Camera is a network device and its use should be straightforward for those who have basic network knowledge.

The Network Camera is designed for various applications including video sharing, general security/surveillance, etc. The "How to Use" chapter suggests ways to best utilize the Network Camera and ensure proper operations.

### Minimum System Requirement

| <b>FCS-4201_4301 Optical Mini PTZ Dome</b>                      |                                                                                                                                                                                                                                      |
|-----------------------------------------------------------------|--------------------------------------------------------------------------------------------------------------------------------------------------------------------------------------------------------------------------------------|
| <b>Network Environment</b>                                      |                                                                                                                                                                                                                                      |
| LAN                                                             | 10/100M Ethernet                                                                                                                                                                                                                     |
| <b>Monitoring System Recommended for Internet Explorer</b>      |                                                                                                                                                                                                                                      |
| System Hardware                                                 | Basic requirements <ul style="list-style-type: none"> <li>· CPU: Intel® Celeron® Dual-Core @2.70GHz or above</li> <li>· Memory Size: 2 GB or above Recommended</li> <li>· VGA card resolution: 1024 x 768 or above</li> </ul>        |
| <b>System Requirement for Viewer &amp; Recorder Application</b> |                                                                                                                                                                                                                                      |
| Support OS                                                      | XP, Windows 7                                                                                                                                                                                                                        |
| System Hardware                                                 | 1-4 cameras surveillance application <ul style="list-style-type: none"> <li>· CPU: Intel® Celeron® Dual-Core @ 2.70GHz or above</li> <li>· Memory Size: 2 GB or above</li> <li>· VGA card resolution: 1024 x 768 or above</li> </ul> |

## Package Contents

If any of the above items are missing, please contact your dealer immediately.

Network Camera (Wired or PoE)

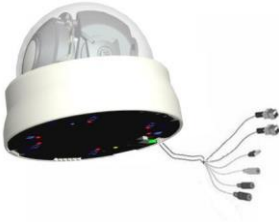

Software CD



Power adapter



Quick installation guide



Screws



RJ45 Female/General I/O Terminal Block

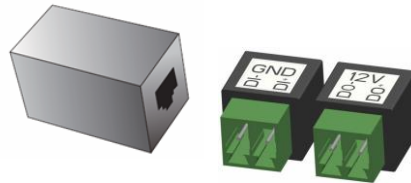

Mounting Kit (indoor)

**Note:** Using a power supply with a different voltage than the one included with the Network Camera will cause damage and void the warranty for this product.

# Connections

## Hardware description\_Indoor\_FCS-4201\_4301

- Outer View



- Inner View

PTZ type



Fixed type



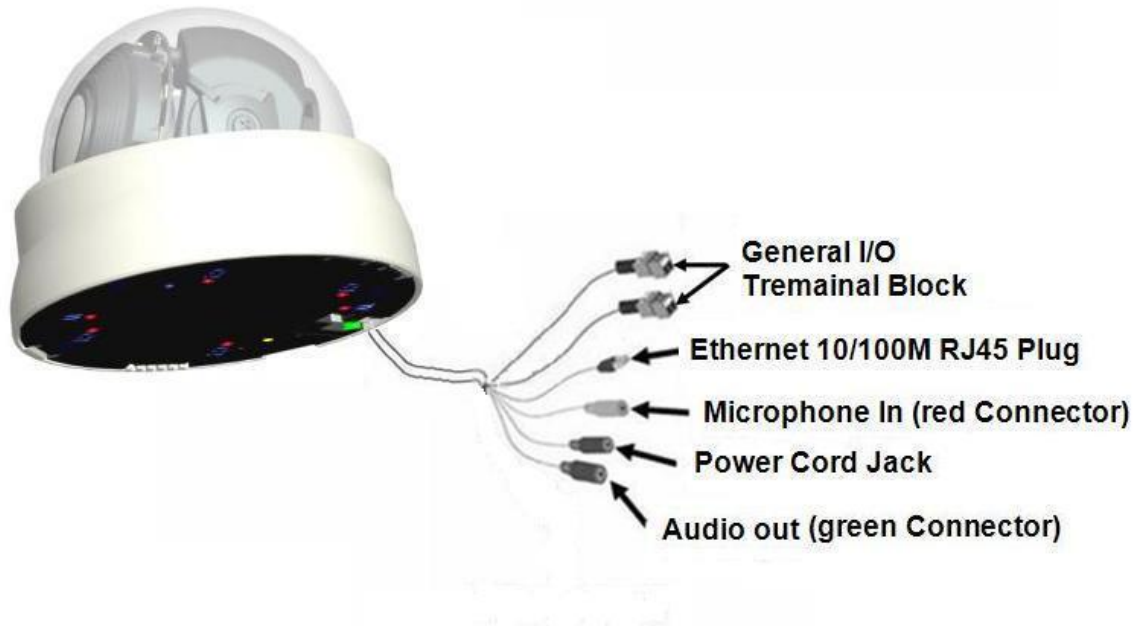

## Hardware description\_Indoor\_FCS-4202\_4302

### ◎ Outer View



© Inner View

**PTZ type**



**Fixed type**

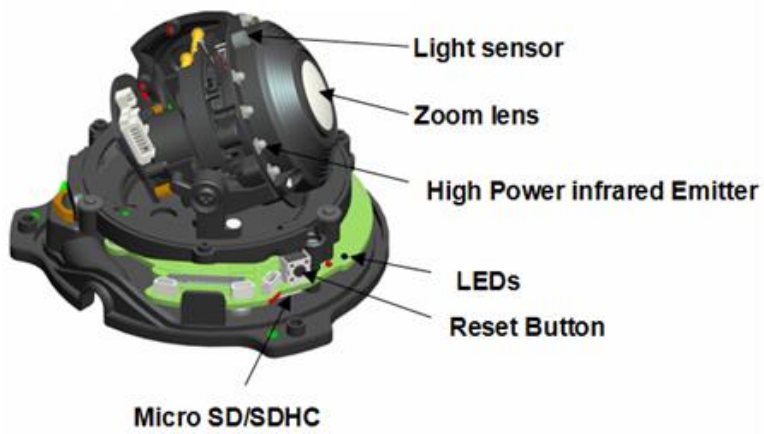



## Hardware Installation

1. Attach the Network Camera with the included stand

2. Place the Camera fix it onto ceiling or wall

Use screws to fix the Network Camera onto the ceiling or wall.

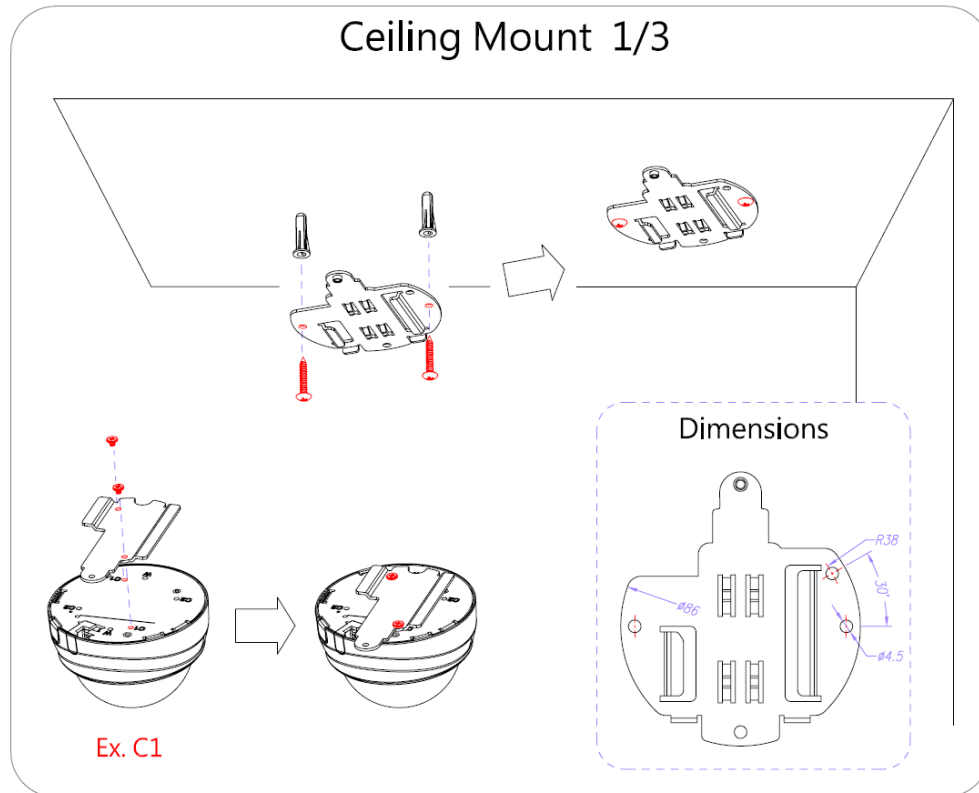

### Ceiling Mount 2/3

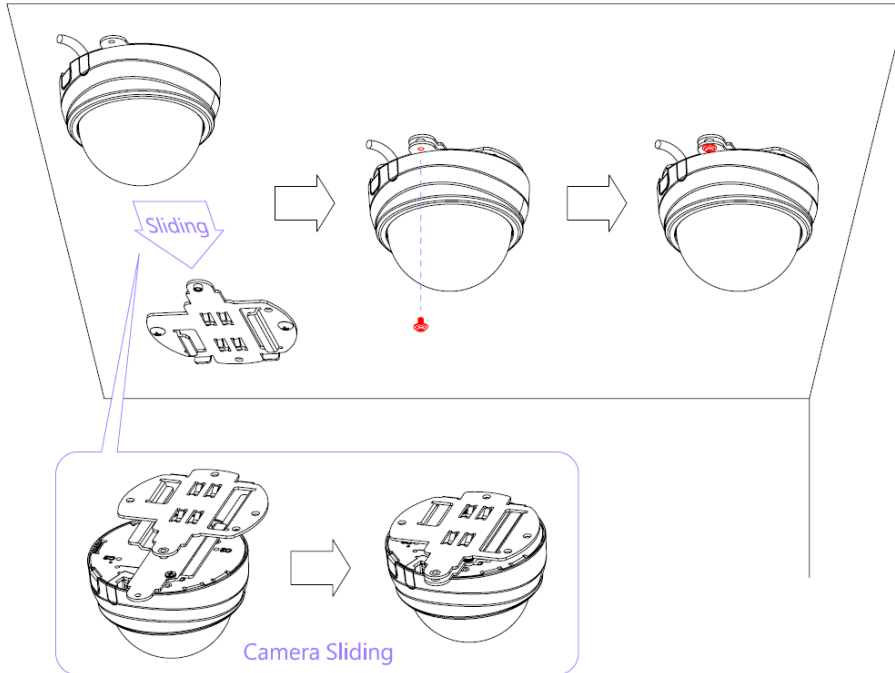

### Ceiling Mount 3/3

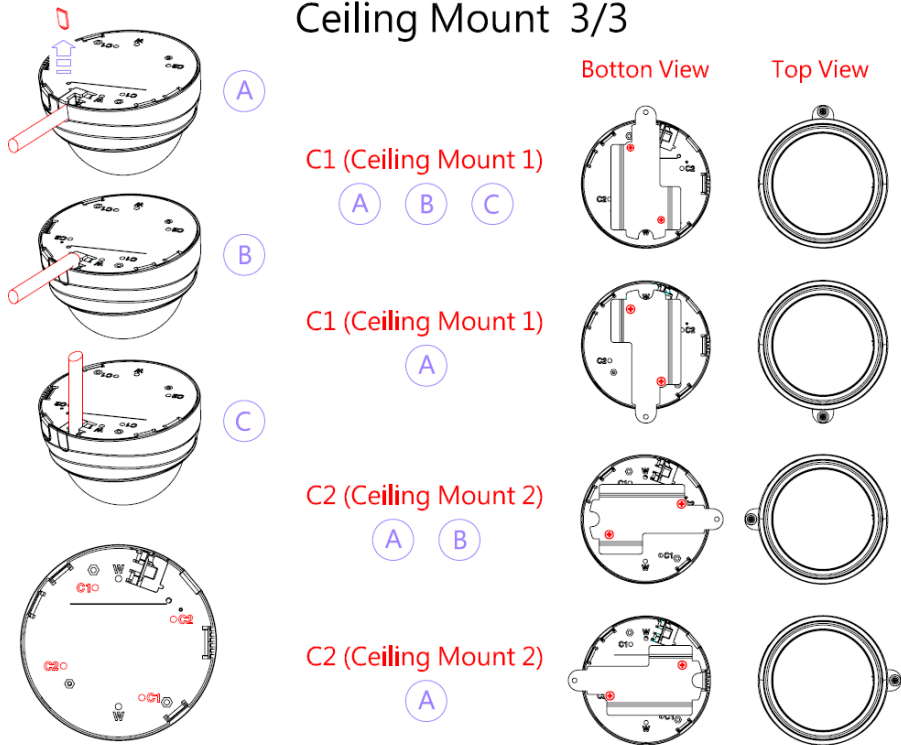

### 3. General I/O Terminal Block

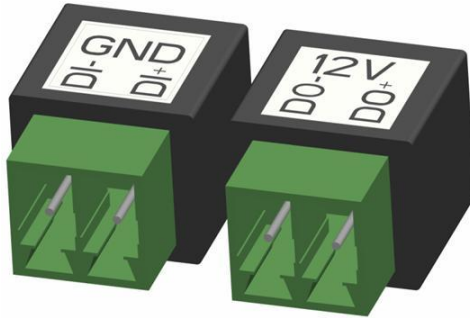

| Name    | Specification  |
|---------|----------------|
| 12V DO+ | Power +12V     |
| 12V DO- | Digital Output |
| GND DI+ | Digital Input  |
| GND DI- | Ground         |

#### DI/DO Diagram

Please refer to the following illustration for the connection method.

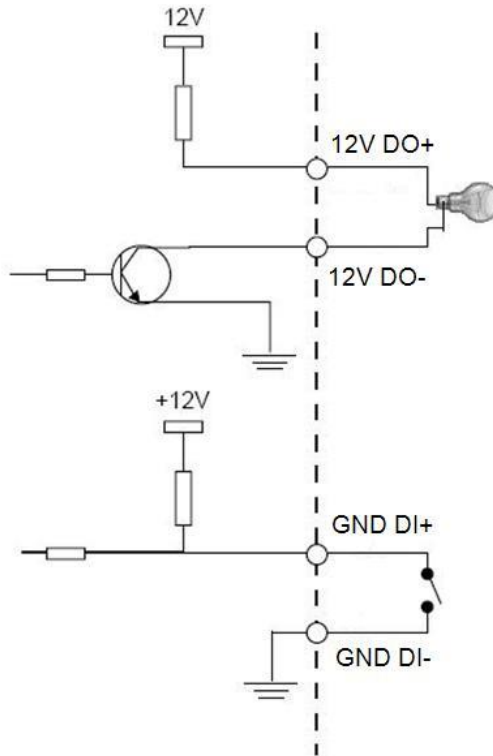

#### 4. Power over Ethernet (PoE)

- **Using a PoE-enabled switch**

The Network Camera is PoE-compliant, allowing transmission of power and data via a single Ethernet cable. Follow the below illustration to connect the Network Camera to a PoE-enabled switch via Ethernet cable.

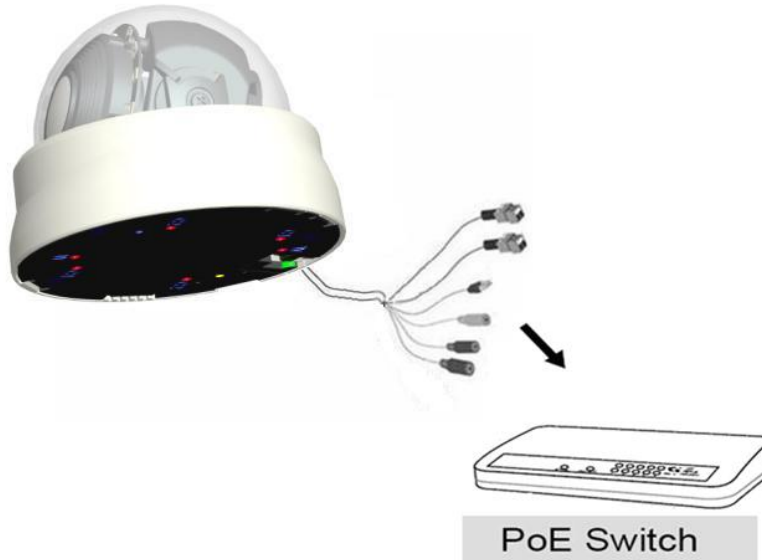

- **Using a non-PoE switch**

Use a PoE power injector (optional) to connect between the Network Camera and a non-PoE switch

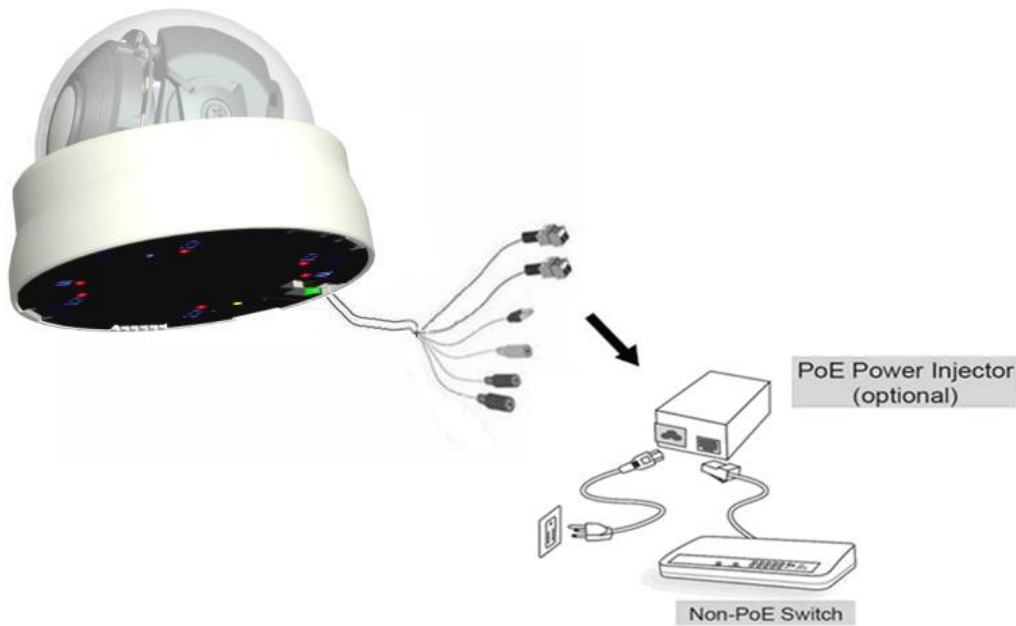

## ***Connect to the Network Camera***

### **Install the IP Finder program**

When you installed your Network camera on your LAN environment, you may install “IP Finder” to discover Network camera’s IP address. The Administrator must place the product software CD into the CD-ROM drive of the PC running in Microsoft Windows. An auto-run program will pop up (If the program is not on auto-run, go to the root directory of the software CD and click on “autorun.exe”).



Click on “Software Utility” item, after the window contents changed, click on “Install Cam Finder” to run “Cam Finder” program.



“Cam Finder” is used to search the IP address of Network Cameras or Video servers on a LAN. After searching, Video Servers or Network Cameras will be located by the Cam Finder.

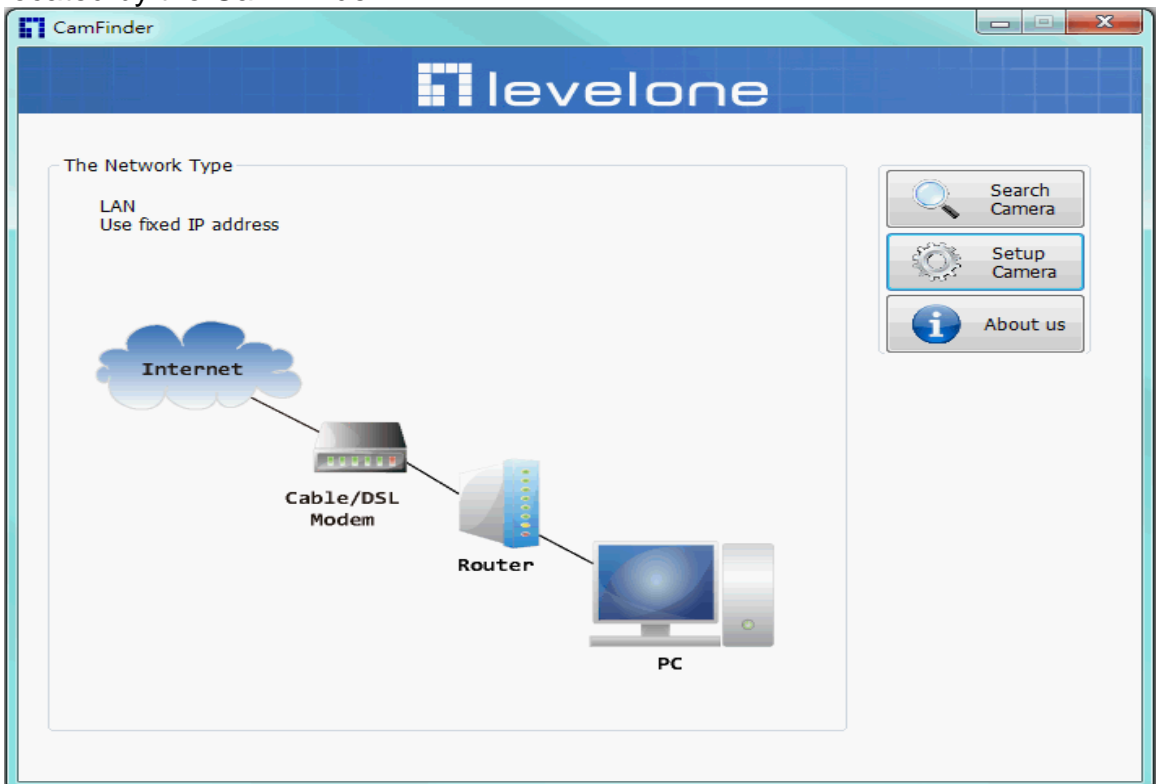

## Search Camera

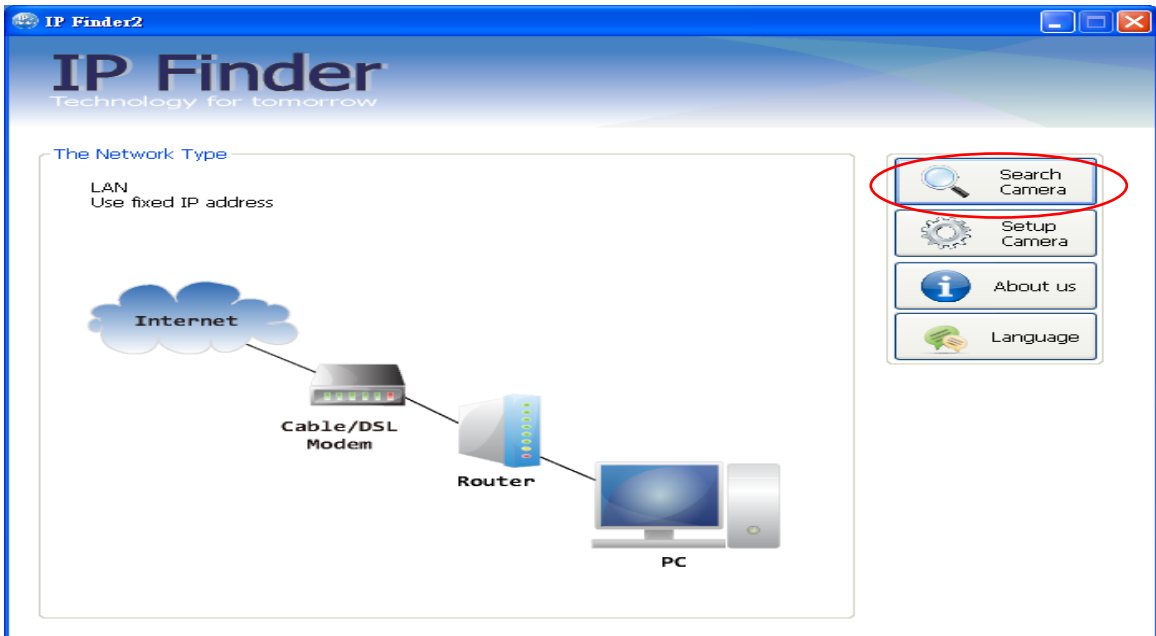

Click search Camera button, The program will search for all family network devices on the same LAN. After searching, the main installer window will pop up. Click on the MAC and model name which matches the product label on your device to connect to the Network Camera via Internet Explorer.

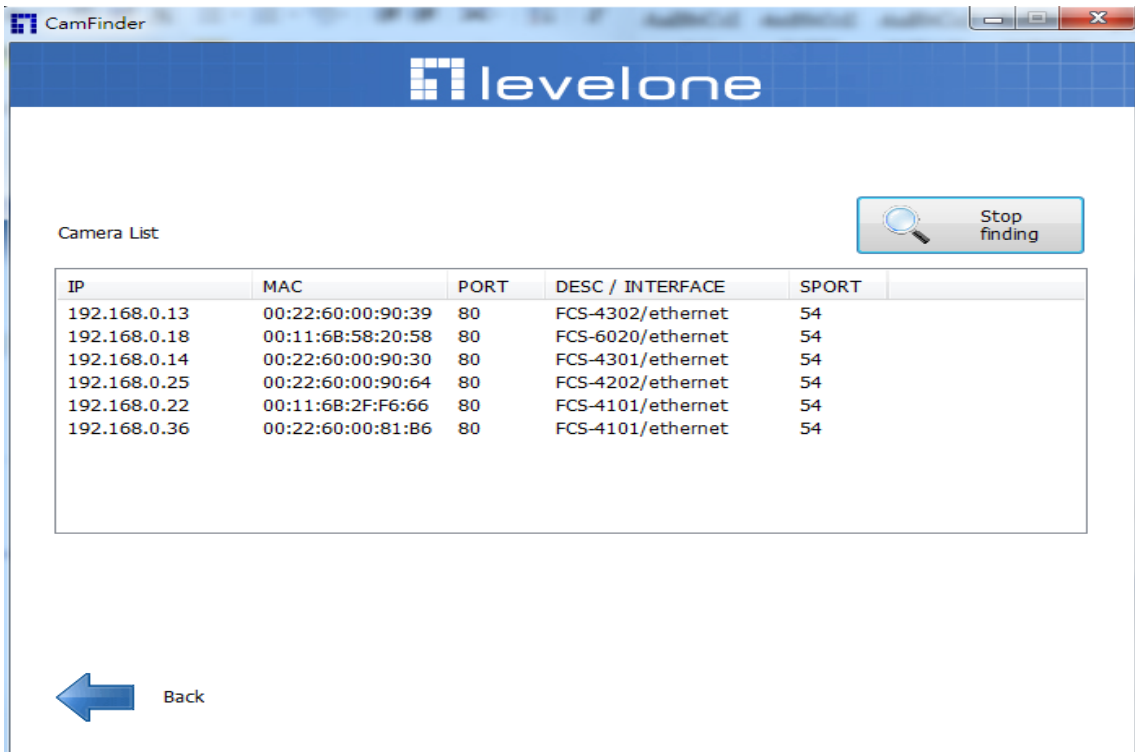

## Setup Camera

Auto Install Wizard will be started and that it can auto guide through the installation process. Press the “**Next**” button execute next process. For more information, please refer to the Network section on page 33.





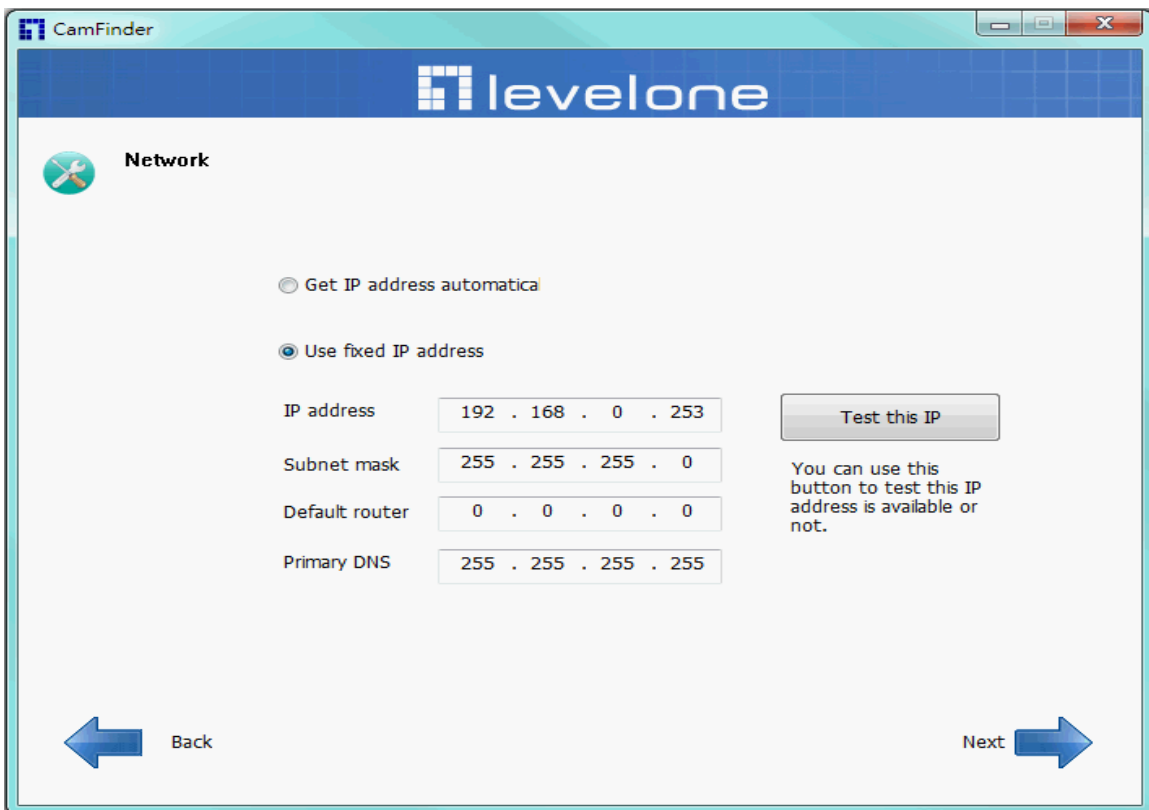
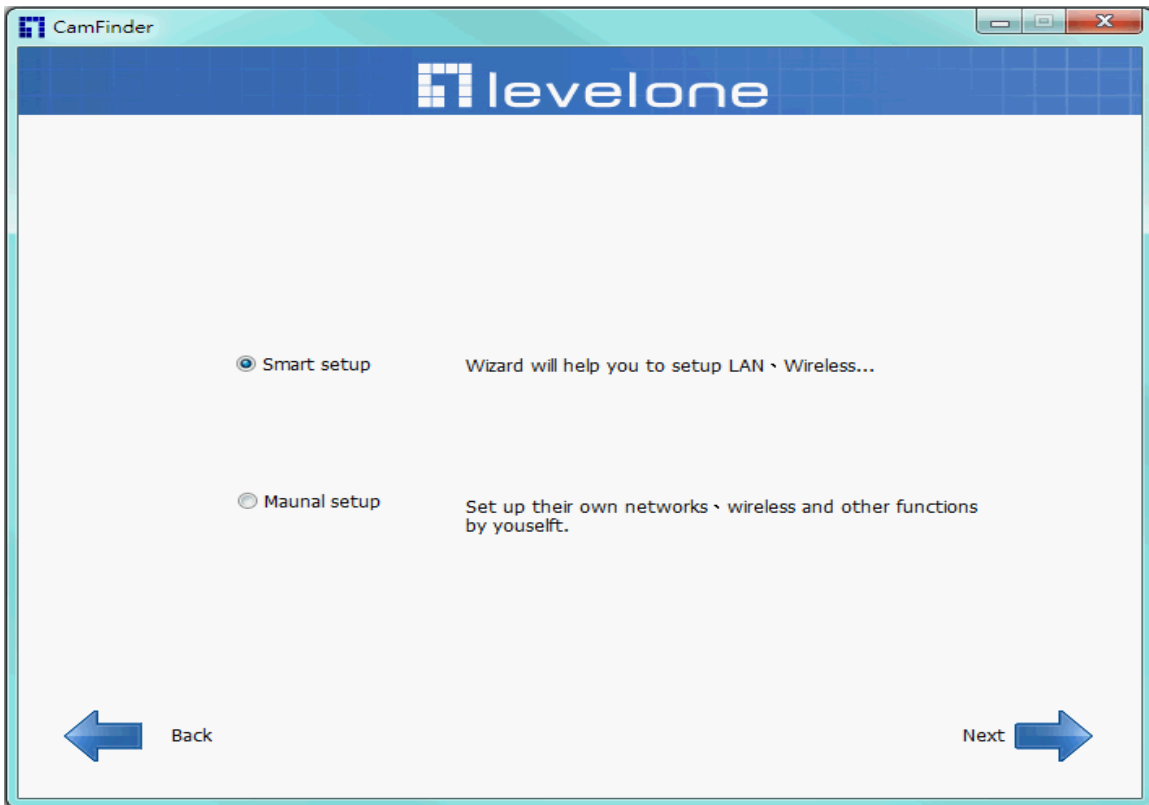

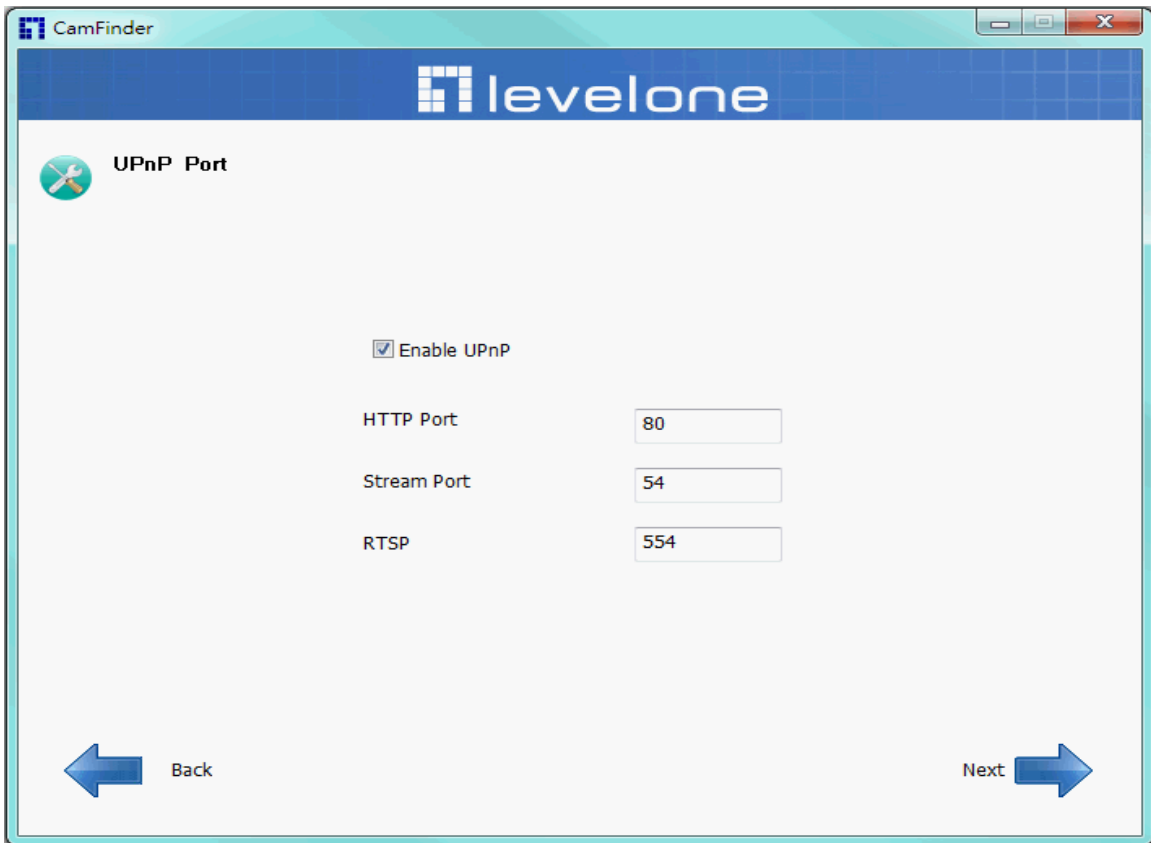

## Bonjour program

Safari browser supports Bonjour search program the will search for all family network devices on the same LAN.

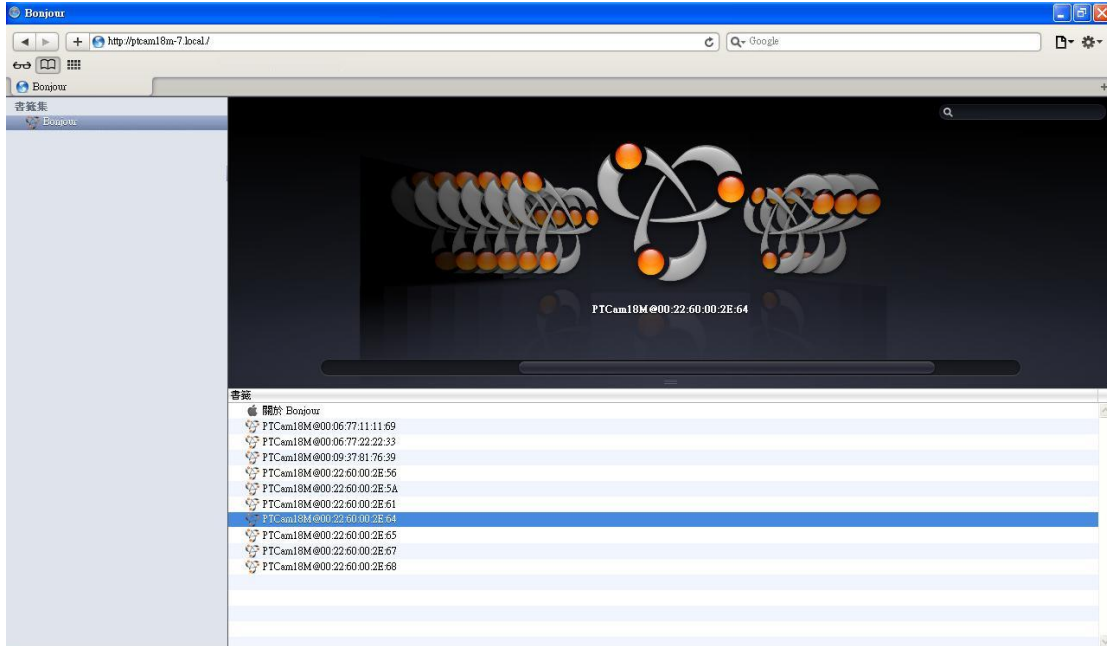

## C2.mylevel1.com(Free DDNS service)

1. When you want to connect the network camera over Internet, you can use the service “**C2.mylevel1.com**”. The “ip-discovery.com” is a free DDNS server for this camera. Make sure that the router must start UPnP and DHCP server functions. You can get the domain name which you wish very easily after registration. In Network page—DDNS settings of this camera, you just input the host name you want and your e-mail address, and click “Register”, then you can have the hostname for this camera not longer than 20 seconds if the DDNS registration result is OK. Then you can connect to this ip camera by

\*<http://XXX.c2.mylevel1.com:@@:@@>

\*XXX: the host name you type

\*@@@: The HTTP port (get it automatically by c2.mylevel1 server)

**DDNS setting**

Please input the C2.mylevel1.com DDNS parameters

Host name  .C2.mylevel1.com

E-mail

The following port numbers is needed to set up at your router's mapping table by yourself. Change the port values if needed. Make sure the values must be the same as that set up at your router's mapping table.

HTTP port

HTTPS port

RTSP port

Video RTP port

Video RTCP port

Audio RTP port

Audio RTCP port

User password: Default the password is last six number of the MAC. To change “root” password at “Security configuration” can change the user password, This “User password” is entered in the ip-discovery.com Password.

Note: You must set the ports between your router and camera manually if the registration is failed.

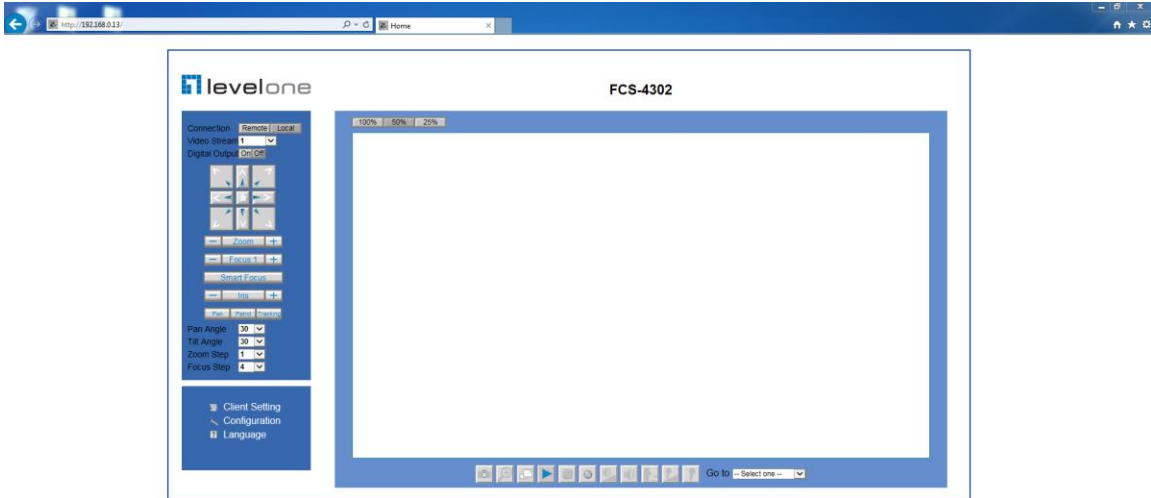

## Initial Access to the Network Camera

- (1) For the initial access to the Network Camera in Windows, the web browser may prompt for permission to install a new plug-in for the Network Camera. This plug-in has been registered for certificate and is used to display the video in the browser. Users may click on  to proceed.

### 1. Click “Install” and “Run” ActiveX controls

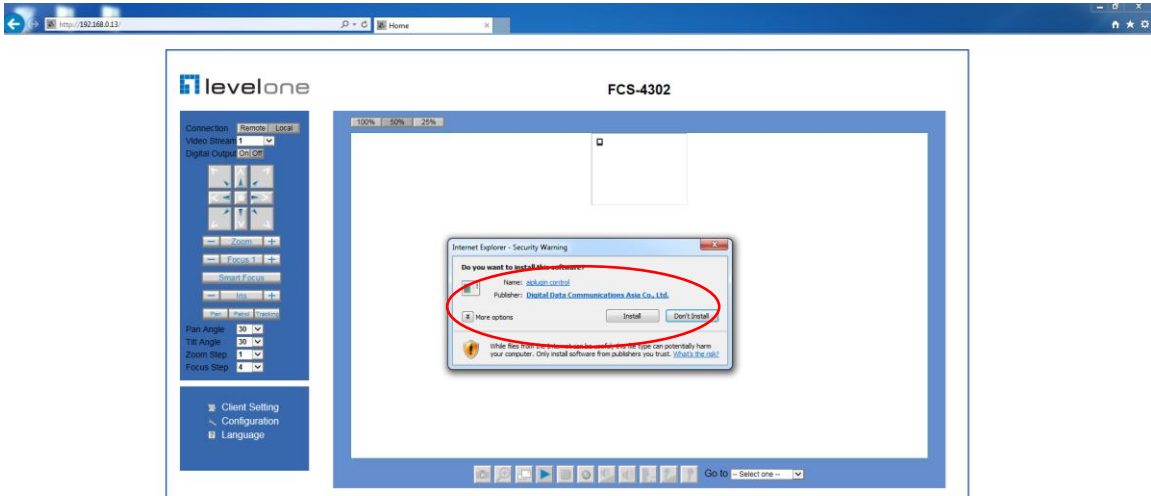

## 2.The video will be displayed.

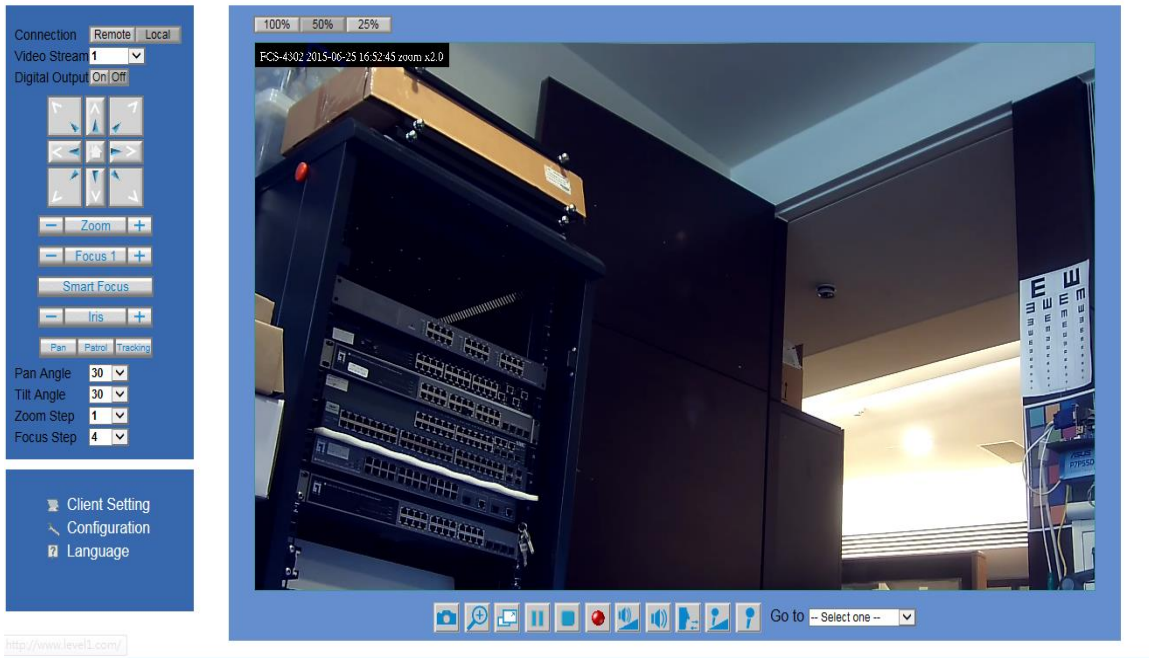

Note: Please contact with your dealer for assistance if the APPs of iPhone, ipad or android phone required for camera.

## Primary user's capability

### Main Screen with Camera View

The main page has three parts:

- 1. Configuration functions:** The camera can be configured using these user interfaces.
  - 2. Pan/Tilt/Zoom & connection control buttons:** These buttons provide the direction to control the pan and tile of camera.
  - 3. Camera View:** What the camera sees.
- Click the configuration in the bottom of left column to link to the configuration page.

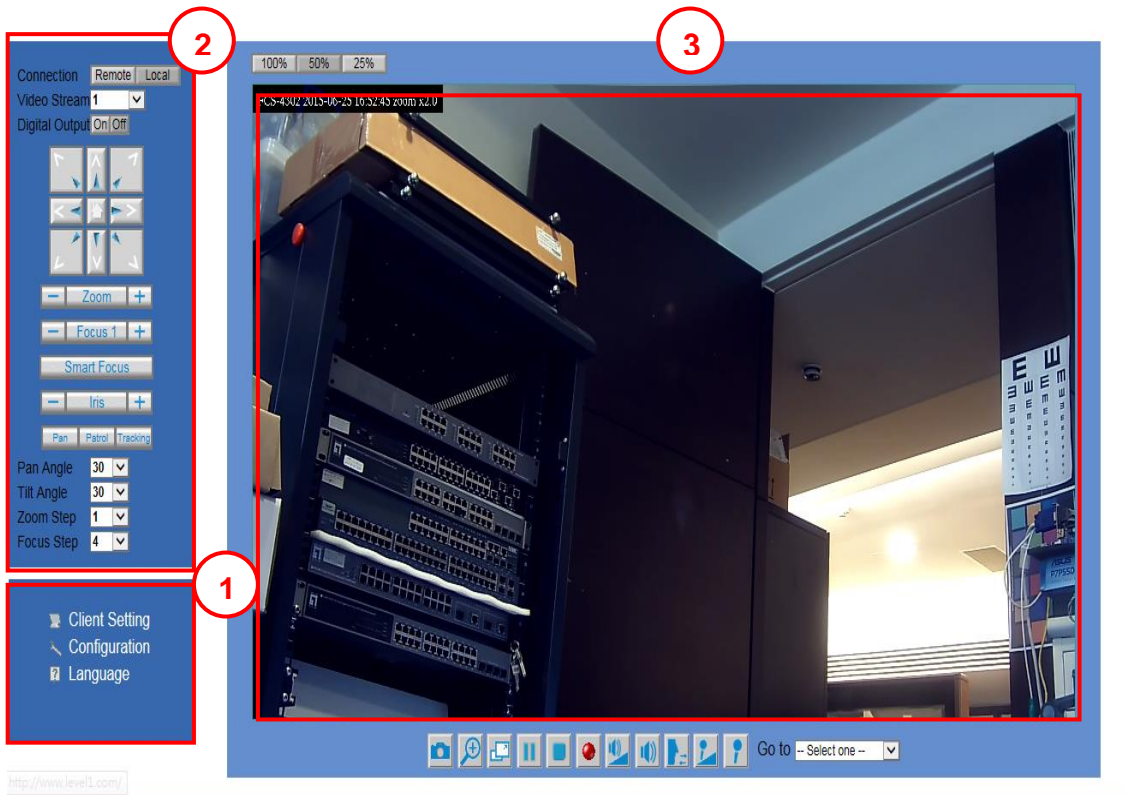

#### Configuration functions:

**“Client Settings”** Clicking on this button links you to the client setting pages, please check the following session for more details.

**“Configuration”** Please notes that only the administrator can access it.

**“ Language”** Click this button to choose a language for the user interface.







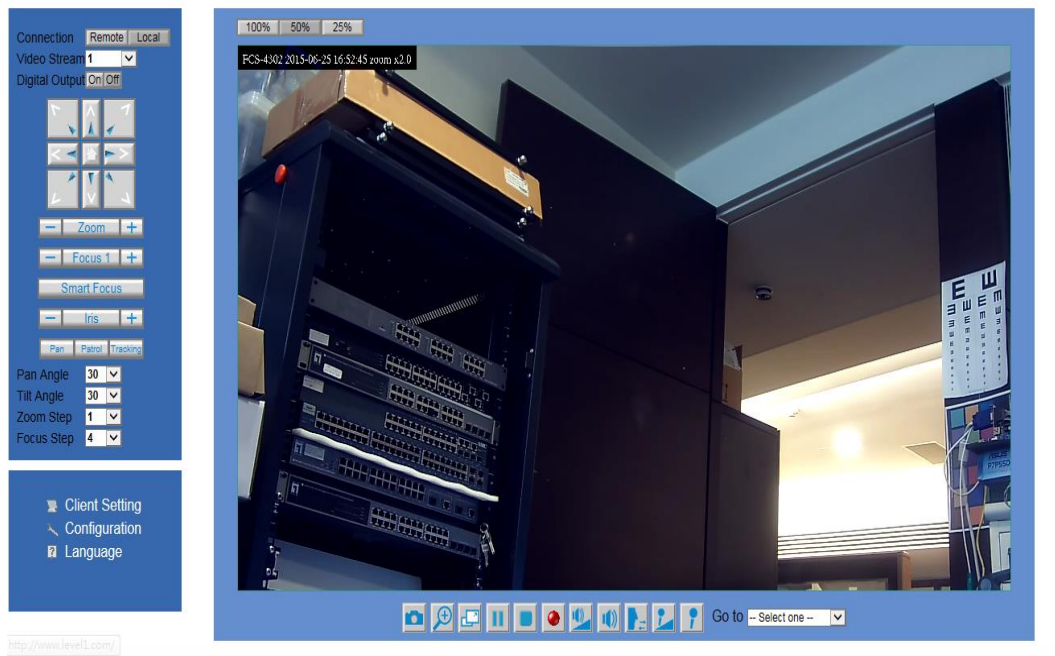



Language options are available in: English, traditional Chinese, Simplified Chinese, Japanese, Spanish, Portuguese, French, German, Italiano.

### Camera view:

On the top of image shows the connecting type of the Network Camera and the current date/time.





### View capabilities:

-  Click this button to capture and save still images. The captured images will be displayed in pop-up window. Right-click the image and choose Save Picture As to save it in JPEG format.
-  The button selection lets you open a digital zoom, and to control the window to enlarge a specified area in the camera view.
-  Click this button to switch to full screen mode. Press the “Esc” key to switch back to normal mode.
-   Click on this button freeze the video, and playing when you click again.
-  Click on this button stop video output.
-  Use this function ; you can record video in your PC by browser directly. The files format will be in MP4. **Note: Due to the UAC (User Access Control) function in Windows Vista or Windows 7, the IE browser would need to be run under the “Administrator” privilege.**
-  Click on this button adjust the audio volume & Latency.
-  Click on this button switch Mute On/Off.
-  Click on this button to adjust the Function “2-way audio” to be Enable/Disable. Enable this function, request insert an external speaker. The server can play sound from



the client and receive sound from the environment and send to client.

10.  Click on this button to adjust the Microphone volume.

11.  Click on this button switch Microphone Mute On/Off.

**12. "Go to" (PTZ type)**

Once the Administrator has determined the preset positions; the User can aim the camera using this control.

**Pan/Tilt/Zoom & connection control buttons:**

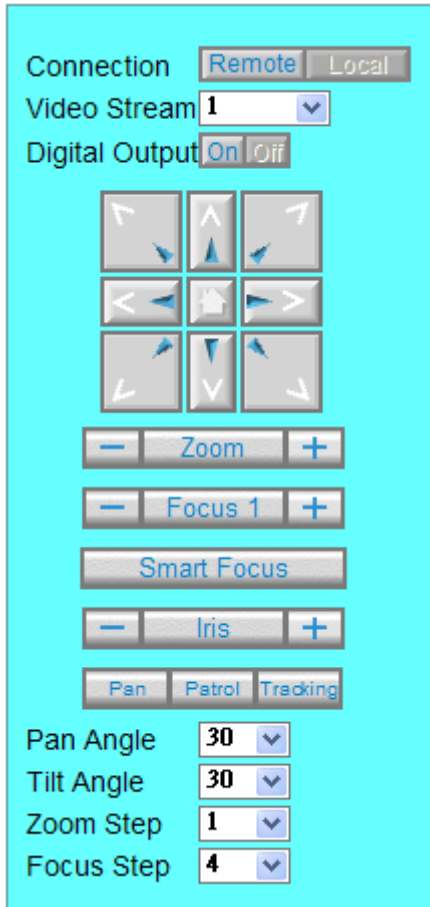

**1. "Connection"** User can choose Remote or Local mode for best connection quality.

**Proposal:** Internet environment, switch Remote mode.

**2. "Video Stream"** User can choose stream1 or stream2.

**3. "Digital Output"** Clicking on the "On" or "Off" button turns the digital output to either on or off status.

**4. "The direction buttons are"** "Left", "Right", "Up", "Down", "Cross Angles", and "Home". Camera returns to center when click "Home" button

**5. "Pan Angle" (PTZ type)**

User can choose the angles when the camera moves left and right each time.

**6. "Tilt Angle" (PTZ type)**

User can choose the angles when the camera moves up and down each time.

**7. "Iris"** Adjust the iris size

**8. "Pan" (PTZ type)**

The camera will move from right side to left side continuously when click the button.

**9. "Patrol" (PTZ type)**

The button directs the camera to patrol among the preset positions in the patrol list, which can be modified on the "Camera control page". The cycle of patrol is from 1 to Unlimit.

**10. "Video Tracking" (PTZ type)**

is able to track dynamic objects within screen video.

**11. "Focus"** There are two different Focus modes, Focus1 and Focus2, press two seconds on the Focus icon to switch the mode. Focus1 is autofocus mode, the camera will do focus after Pan/Tilt moving, Zoom in/out, any large video difference...and so on. Focus2 mode, the camera will do focus after Zoom in/out and IR turn on/off.

**13. "Smart Focus"** Smart Focus function, use mouse and left key to pull a area, and then the camera will focus to this area.

**14. "3D Auto location" (PTZ type)**

Press the left key of the mouse, and pull and choose a certain area in the picture in diagonal direction, can enlarge this area, and put this area in the middle position of picture of controlling.

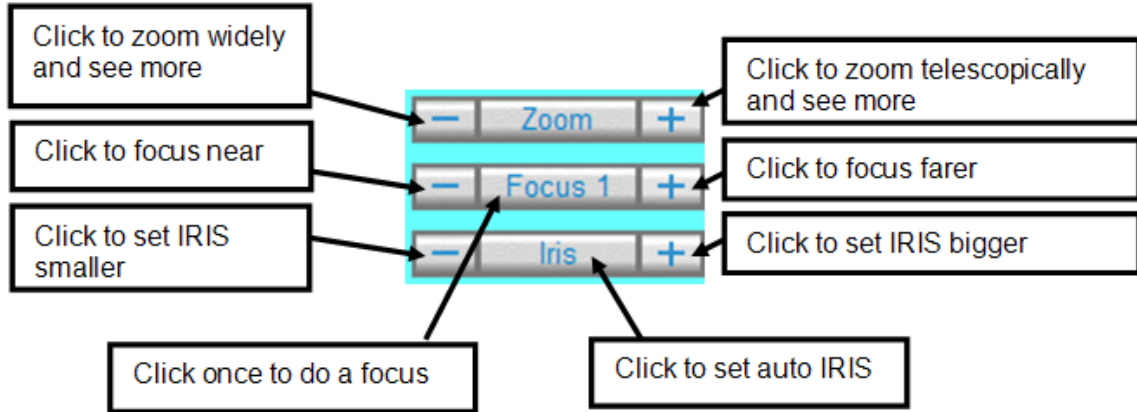

The screenshot shows the camera's web interface with a sidebar on the left containing menu items: Camera control, Application, Storage, System log, Status and parameters, and Maintenance. The main content area is divided into two sections:

- Preset point setting**:
  - The current home position is (255,20)
  - The current auto pan range is (200,0) ~ (300,0)
  - The preset points list as following:
    - a (255,20)
    - b (341,20)
  - Setup button
- Patrol list setting**:
  - Please set the patrol list
  - Preset points list: a, b
  - Patrol list:
    - a dwell 5 second(s)
    - b dwell [ ] second(s)
  - Remove patrol point button
  - Cancel and Finish buttons

## Client Setting

Client setting  
1.0.4.3

Home

**Internet setting**

UDP  
 TCP  
 HTTP

**Intranet setting**

UDP  
 TCP  
 HTTP

**Recording options**

Folder:

File name prefix:

Add date and time suffix to file name

1. **“Intranet Protocol Options”** Setting camera in intranet mode of protocol.
  - “UDP” Select use UDP protocol connect camera.
  - “TCP” Select use TCP protocol connect camera.
  - “HTTP” Select use HTTP protocol connect camera.
2. **“Internet Protocol Options”** Setting camera in internet mode of protocol.
  - “UDP” Select use UDP protocol connect camera.
  - “TCP” Select use TCP protocol connect camera.
  - “HTTP” Select use HTTP protocol connect camera.
3. **“Recording options”** Users can record live video as they are watching by clicking  start MP4 Recording on the main page. Here, you can specify the storage destination and file name.
  - “Folder” Specify the storage destination for the recorded video files.
  - “File name prefix” Enter the text that will be appended to the front of the video file name.

**“Add date and time suffix to file name”** Select this option to append the date and time to the end of the file name.

**NOTE :** Protocol Options which allows choices on connection protocol between client and server. There are three protocols choices to optimize your usage – UDP,TCP,HTTP. The UDP protocol allows for more real-time audio and video streams. However, some packets may be lost due to network burst traffic and images may be obscured. The HTTP protocol allows for less packet loss and produces a more accurate video display. The downside with this protocol is that the real-time effect is worse than that with the UDP protocol.

The TCP guarantees the complete delivery of streaming data and thus provides better video quality. However, the real-time effect is not as good as that of the UDP protocol. If no special need is required, UDP protocol is recommended. Generally speaking, the client choice will be in the order of UDP → HTTP. After the Network Camera is connected successfully, “Protocol Option” will indicate the selected protocol. The selected protocol will be recorded in the user's PC and will be used for the next connection. If the network environment is changed, or the user wants to let the web browser to detect again, manually select the UDP and TCP protocol, save, and return HOME to re-connect.

## Definitions in Configuration

Please note that only the Administrator can access the system configuration.

### System parameters

The screenshot displays the configuration interface for a Network Camera. On the left is a vertical navigation menu with the following items: Home, System, User management, Network, Access list, Audio and video, Video record, Stream, Camera control, Application, Storage, System log, Status and parameters, and Maintenance. The 'System' menu item is selected. The main content area is titled 'System 1.0.4.3' and 'Firmware version', which is highlighted with a red box. Below this, there are three configuration sections: 'General setting' with fields for 'Host name' (Network Pan/Tilt Camera) and 'Led indicator' (Turn on); 'Time setting' with fields for 'Time zone' ((GMT+09:00) Osaka, Sapporo, Tokyo, Seoul, Yakutsk), 'Daylight saving time' (Disable), and 'Current Time' (2012/11/02 09:48:26); and 'DI and DO setting' with fields for 'Digital input' (The active state is "high level", The current state detected is "low level") and 'Digital output' (The active state is "grounded", The current state detected is "open"). Each section has a 'Setup' button.

#### 1. "General Setting"

##### (1) "Host name"

The text displays the title on the top of the main page.

##### (2) "LED indicator"

Select turn on or turn off the led indicator.

## 2. "Time Setting"

### (1) "Time zone"

Choose a time zone from the down arrow.

### (2) "Daylight saving"

For summertime; It will be one hour ahead.

### (3) "Current Time"

Network camera set the current time.

#### (A) "Keep current date and time"

Click on this to keep the current date and time of the Network Camera. An internal real-time clock maintains the date and time even when the power of the system is turned off.

#### (B) "Sync with computer time"

Synchronize the date and time in the Network Camera according to the local computer.

#### (C) "Manual"

Adjust the date and time by the Administrator.

#### (D) "Adjust by NTP server"

Synchronize the time according NTP server over the Internet whenever the Network Camera is switched on. It fails if the assigned time-server cannot be found.

**(a) "NTP server"** Assign the IP address or domain name of the time-server. Leaving the text box blank connects the Network Camera to the default time-servers.

**(b) "Update interval"** Select 0 ~ 23 hours update with the time on the NTP server.

## 3. "DI and Do Setting"

Select **Open** or **Ground** to define the DO active state.

Remember to click on "**Finish**" to immediately validate the changes. Otherwise, the correct time will not be synchronized.

# Security

The screenshot shows the 'User management' interface. The top right corner displays 'User management 1.0.4.3'. On the left is a vertical navigation menu with the following items: Home, System, User management (highlighted), Network, Access list, Audio and video, Video record, Stream, Camera control, Application, Storage, System log, Status and parameters, and Maintenance. The main content area is titled 'Security setting' and contains the following information:

- Users' privilege**
  - The operators can use : (1) Digital output function (2) Connection selection
  - The viewers can use : (1) Digital output function (2) Connection selection
- Users**
  - There are 0 administrator
  - There are 0 operator
  - There are 0 viewer

A 'Setup' button is located at the bottom right of the main content area.

## Security setting

The administrator account name is “root”, which is permanent and can not be deleted. If you want to add more accounts in the Manage User column, please set a password for the “root” account first.

**1. “Change root password”** Change the Administrator’s password by typing in the new password identically in both text boxes. The typed entries will be displayed as asterisks for security purposes. After pressing **“finish”**, the web browser will ask the Administrator for the new password to access.

**2. “Manage privilege”** You can modify the manage privilege of operators or viewers. Check or uncheck the item, then click **finish** to enable the settings.

### 3. “Manage user”

**(1) “Add a new user”** Administrators can add up to 20 user accounts.

(A) Input the new user’s name and password.

(B) Select the privilege level for the new user account. Click **Finish** to enable the



setting.

**(2) "Delete a user"** Select an existing user name. Click **Finish** to enable the setting.

**(3) "Update a existing user"** Select an existing user name. Administrators can modify user's password and privilege. Click **Finish** to enable the setting.

Access rights are sorted by user privilege (Administrator, Operator, and Viewer). Only administrators can access the Configuration page. Operators cannot access the Configuration page but can use the URL Commands to get and set the value of parameters. Viewers access only the main page for live viewing.

# Network

Any changes made on this page will restart the system in order to validate the changes. Make sure every field is entered correctly before clicking on **“finish”**

## Network Setting

### “LAN” & “PPPoE”

The default type is LAN. Select PPPoE if using ADSL

#### 1. LAN

The default status is **Get IP address automatically**. This could be tedious to perform software installation whenever the Network Camera starts. Therefore, once the network is set, especially for the IP address should be entered correctly. Select **Use fixed IP address** then the Network Camera will skip installation. The Network Camera will automatically restart and operate normally after a power outage. You can run IP installer to check the IP address assigned to the Network Camera if the IP address is forgotten,

or you can use the UPnP function provided by the Network Camera (**MS Windows XP provides UPnP function at My Network Place**).

**(1) "Get IP address automatically"**

**(2) "Use fixed IP address"**

- **"IP address"**: This is necessary for network identification.
- **"Subnet mask"**: This is used to determine if the destination is in the same subnet. The default value is "255.255.255.0".
- **"Default router"**: This is a gateway used to forward frames to destinations in a different subnet. Invalid router setting will fail the transmission to destinations in different subnet.
- **"Primary DNS"**: The primary domain name server that translates hostnames into IP addresses.
- **"Secondary DNS"**: Secondary domain name server backups the Primary DNS.
- **"Enable UPnP presentation & port forwarding"**: Enable UPnP ability.
- **"Http port"** This can be typed besides the default Port 80. Once the port is changed, the users must make sure the change for the connection is successful. For instance, when the Administrator changes the HTTP port of the Network Camera which IP address is 192.168.0.20 from 80 or 1025 to 65535, the users must type in the web browser "http://192.168.0.20:8080" instead of "http://192.168.0.20".
- **"RTSP Port"** RTSP port can be typed besides the default Port 554
- **"RTP Port"** The RTP port can be typed besides the default Port 54  
Note: Please set Video RTP port in even number after default value port 54. Then, Video RTCP port, Audio RTP port, Audio RTCP port will automatically set the values in ascending.
- **"RTSP Streaming access names"** The RTSP streaming currently supports video only, audio only, and audio/video. To use the audio/video stream, type the URL as "rtsp://61.30.125.43/liveN.sdp".

## 2. PPPoE

If using the PPPoE interface, you should fill the following settings from ISP.

- (1) "User name"**: The login name of PPPoE account
- (2) "Password"**: The password of PPPoE account
- (3) "Confirm password"**: Input password again for confirmation

## DDNS Setting

- 1. "Enable DDNS"** This option turns on the DDNS function.
- 2. "ip-discovery"** In the Register column, fill in the Host name (xxxx.ip-discovery), Email, Key, and Confirm Key, then click Register. After a host name has been successfully created, a success message will be displayed in the DDNS Registration Result column and messaging E-mail.
- 3. "3rd party DDNS"** This is enable or disable 3<sup>rd</sup> party DDNS.
- 4. "Provider"** The provider list contains hosts that provide DDNS services. Please connect to the service provider's website to make sure the service charges.
- 5. "Host Name"** If the User wants to use DDNS service, this field must be filled. Please input the hostname that is registered in the DDNS server.

**6. "User name"** The Username or E-mail field is necessary for logging in the DDNS server or notify the User of the new IP address.

**Note:** when this field is input as "User name", the following field must be input as "Password".

**7. "Password"** Please input the password or key to get the DDNS service.

**8. "finish"** Click on this button to save modify settings for the DDNS service.

# Access list

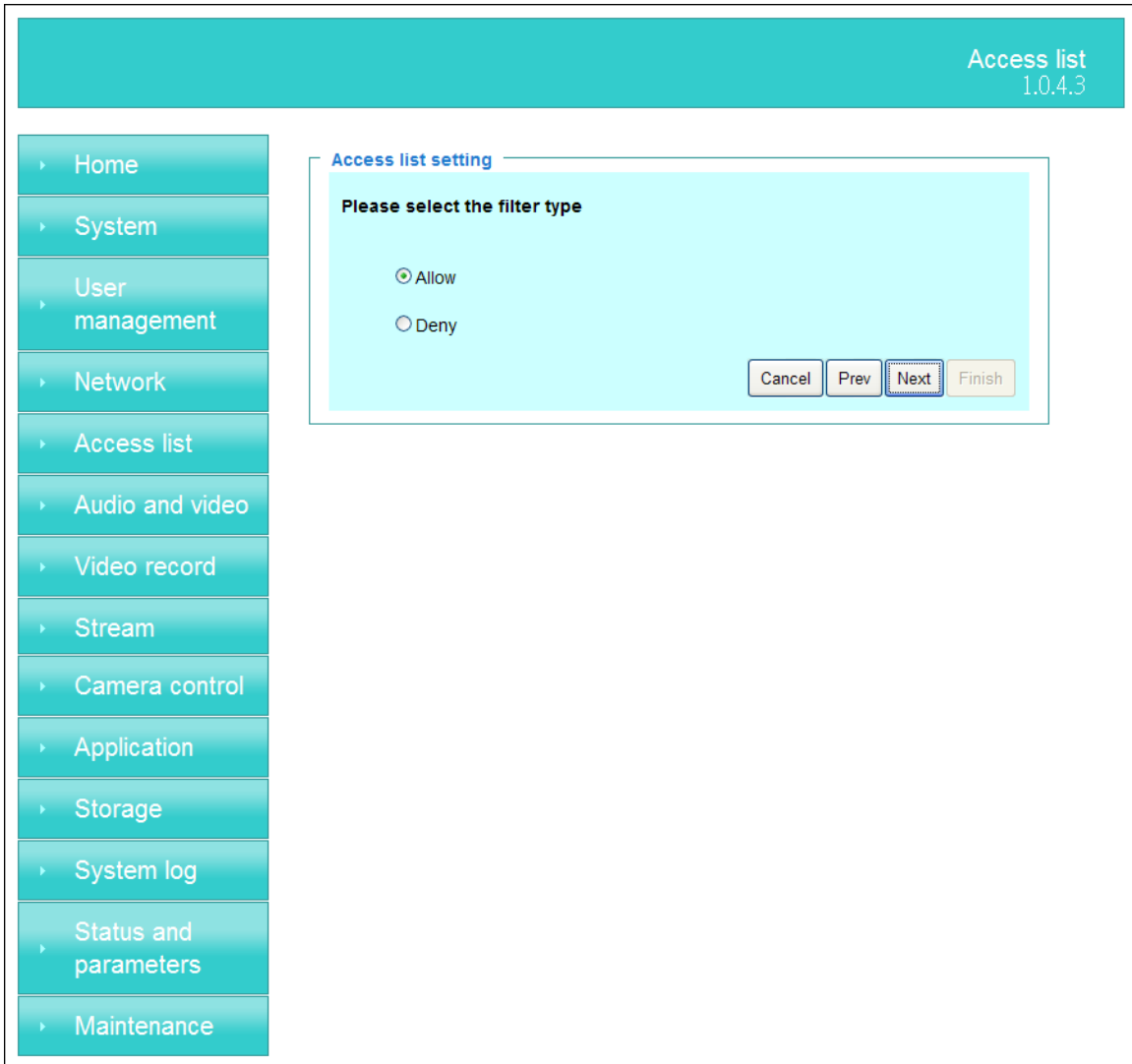

## Access list setting

1. How to control access permission by verifying the client PC's IP address. **General Settings.**

### General Settings

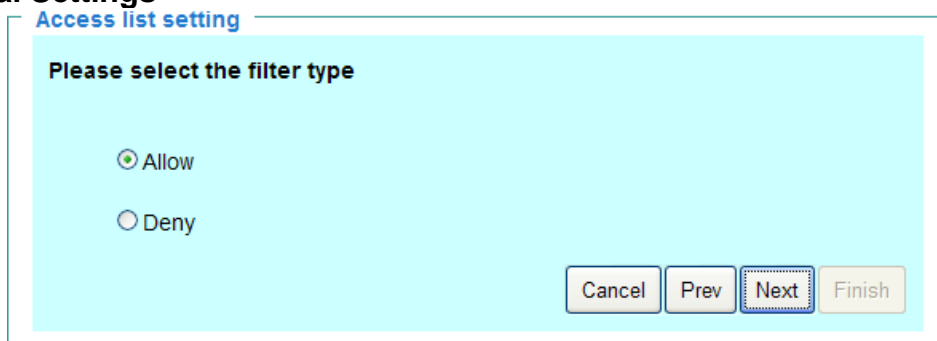

◆ **Add a rule to configure an Allowed/Denied list: Click Add to add a rule to Allowed/Denied list.**

There are three types of rules for user to set up:

“**Single**” This rule allows the user to add an IP address to the Allowed/Denied list.

For example:

The screenshot shows a dialog box titled "Access list setting" with the instruction "Please select add/delete the access list". It contains two radio button options: "Only change filter type" (unchecked) and "Add address" (checked). Under "Add address", there is a "Rule" dropdown menu set to "Single" and an "IP address" text input field containing "192.168.200.5". Below these, there is a "Delete address" radio button (unchecked) and an "Address list" dropdown menu. At the bottom right, there are four buttons: "Cancel", "Prev", "Next", and "Finish".

“**Network**” This rule allows the user to assign a network address and corresponding subnet mask to the Allow/Deny List. The IP address is written in the CIDR format.

For example:

The screenshot shows a dialog box titled "Access list setting" with the instruction "Please select add/delete the access list". It contains two radio button options: "Only change filter type" (unchecked) and "Add address" (checked). Under "Add address", there is a "Rule" dropdown menu set to "Network" and a "Network address / Network mask" text input field containing "192.168.200.0 / 24". Below these, there is a "Delete address" radio button (unchecked) and an "Address list" dropdown menu. At the bottom right, there are four buttons: "Cancel", "Prev", "Next", and "Finish".

**“Range”** This rule allows the user to assign a range of IP addresses to the Allow/Deny List. This rule is only applied to IPv4.  
For example:

**Access list setting**

**Please select add/delete the access list**

Only change filter type

Add address

Rule

IP address - IP address  -

Delete address

Address list

# Audio and Video setting

Audio and video  
1.0.4.3

- ▶ Home
- ▶ System
- ▶ User management
- ▶ Network
- ▶ Access list
- ▶ Audio and video
- ▶ Video record
- ▶ Stream
- ▶ Camera control
- ▶ Application
- ▶ Storage
- ▶ System log
- ▶ Status and parameters
- ▶ Maintenance

**General setting**

**Current color mode is**  
color

**Current video is**  
flip : off / mirror : off

**Current environment is**  
indoor

**Current video frequency is**  
60hz

**Video setting**

**Current video contrast is**  
1

**Current video brightness is**  
0

**Current video saturation is**  
-1

**Current video sharpness is**  
-2

**Current video EV is**  
1

**Current video gain is**  
1x ~ 8x

**Exposure setting**

**Current auto-exposure mode is**  
Auto

**Current exposure control**  
Target luminance is 75,  
Offset is 20,  
Gain is 1x ~ 8x,  
Shutter Speed is 1 / 1000000 ~ 1 / 30

**Noise reduction**

**Current 2D/3D-NR is**  
Enable

**Mode is**  
3D

**WDR setting**

**Current WDR is**  
Disable

**Infrared led setting**

**The infrared led mode is**  
auto mode,  
value is 1

**The low lux mode is**  
off

**Video output setting**

**Video output is**  
Enable

**Current format is**  
NTSC

**Audio setting**

**The microphone is**  
internal microphone,  
and microphone volume is 40



## General Setting

1. **“Color mode”** Select use color or monochrome video display.
2. **“Video orientation”** The orientation of video
  - (1) **“Flip”** Vertically rotate the video.
  - (2) **“Mirror”** Horizontally rotates the video.
3. **“Environment”** The orientation of video
  - (1) **“indoor”** This option is usually selected when the Network Camera is placed in indoor environments.
  - (2) **“outdoor”** This option is usually selected when the Network Camera is placed in outdoor environments.
4. **“Power freq.”** Select 50 Hz or 60Hz power line frequency.

※The fluorescent light will flash according to the power line frequency that depends on local utility. Change the frequency setting to eliminate uncomfortable flash image when the light source is only fluorescent light.

## Video Setting

1. **“Contrast”** Adjust the image contrast level, which ranges from -5 to +5.
2. **“Brightness”** Adjust the image brightness level, which ranges from -5 to +5.
3. **“Saturation”** Adjust the image saturation level, which ranges from -5 to +5.
4. **“Sharpness”** Adjust the image sharpness level, which ranges from -5 to +5.
5. **“EV”** Exposure value represent the expected target value of the luminance of the weighting result of AE windows in the image and its tolerance as offset.
6. **“Gain”** In the slide bar of Gain, there are also two sliders, which represent the limitations to control the maximum gain value and the minimum one, respectively. Normally, the minimum value is to 1x for better quality.

## Exposure setting

Here it provides 3 mode: **Auto**, **Backlight** and **Customized**. **Auto** and **Backlight** modes are 2 default settings for general purpose and backlight scene, respectively.

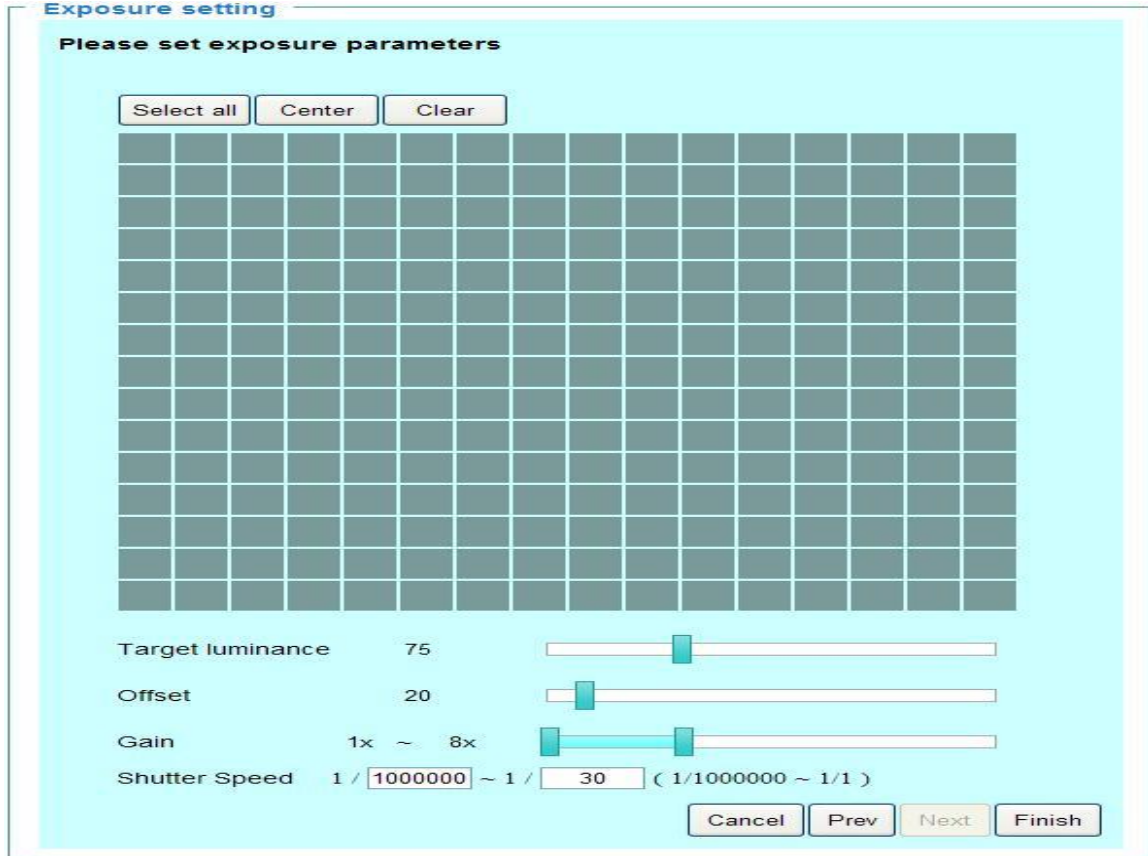

**Customized** mode relates to the grid window above can be pointed on for interesting areas. Within the mode Customized, 16\*15 grids windows can be chosen to match where/what you are interested in. Push down left-button of mouse and drag to draw the grids for interesting areas, or push down right-button of mouse and drag to clean the grids for insignificant areas.

### “Target Luminance and Offset”

These two slide bar, **Target Luminance** and **Offset** represent the expected target value of the luminance of the weighting result of AE windows in the image and its tolerance as offset. For example, target luminance is set to 100 and target offset is set to 20 that means the average luminance of the AE window should be in the range from 80 to 120 ( $100 \pm 20$ ). When the actual luminance does not meet this range, the AE function will adjust shutter and gain to meet it as possible. In some extreme cases, it cannot reach the target because the environment is too bright or dark. When the environment is not consistent, e.g. with big moving objects, and the offset is too narrow, the AE will act more frequently that will cause the background of view inconsistent. The offset value is recommended to

set 15~25% of target luminance.

### “Gain”

In the slide bar of **Gain**, there are also two sliders, which represent the limitations to control the maximum gain value and the minimum one, respectively. Normally, the minimum value is to 1x for better quality. It is not allowed if the maximum slider and the minimum one are set to the same value without adjustable interval. Besides, the noise will be increased if the actual gain is too large. When the max. slider is dragged over sensor's max. gain, the slide bar will become deep blue to represent it will apply Mozart 3s digital gain, which extend the max. gain for very low light.

### “Shutter Speed”

There are 2 fields, minimal and maximal time, for the range of **Shutter Speed**. The precision of the parameter is 1/1000000 sec., but it is **NOT** actual precision of the shutter speed of the sensor. The actual precision of the shutter speed depends on each sensor's specification. Here it will be rounded to approach sensor's effective exposure time. To avoid flickering or banding phenomenon under fluorescent light, the actual shutter speed will be locked at 1/120, 1/60, 1/30 if **Power Line Frequency** is 60Hz, or 1/100, 1/50, 1/25 if **Power Line Frequency** is 50Hz. The setting of **Power Line Frequency** is on the sub-tab Video and Audio. The exposure may not be stable if the maximum value and the minimum one are set to the same value without adjustable interval. Besides, the frame rate will drop down if the actual shutter speed is too slow to meet expected frame rate.

### Noise reduction

Provides 2D and 3D features.

### Wide Dynamic Range

Enable **Wide Dynamic Range** auto in different level to improve the exposure when both bright and dark areas simultaneously in the field of view of the camera. The default is off.

### Infrared Led Setting

- 1. “Infrared LED Control”** IR led for Day and Night (Option). User can turn on/off the built-in IR led. This function is very useful under low illumination environment.
  - (1) “Auto”** Select IR sensitivity from 0 to 4.
  - (2) “Manual”** Turn on/off the IR led manually.
    - **“Turn on”** Turn on led
    - **“Turn off”** Turn off led
- 2. “Low lux mode”** The video quality will be improved when the camera is in low lux environment.
  - (1) “Disable dark mode”** Disable low lux mode.
  - (2) “Enable dark mode”** Enable low lux mode.

## Audio Setting

1. **“Mute”** Audio mute.
2. **“Microphone ”** Internal microphone or external microphone select.
3. **“Mic Volume”** Adjust microphone volume, which ranges from 1 to 64.

## Video record

Record  
1.0.4.3

Home  
System  
User management  
Network  
Access list  
Audio and video  
Video record  
Stream  
Camera control  
Application  
Storage  
System log  
Status and parameters  
Maintenance

**Record setting**

**Video record is currently**  
Enable

**The record schedule is**  
everyday  
time: from 00:00:00 to 23:59:59  
Enable cyclic recording

**The record name is**  
Source :Stream1  
The recording interval 1 minute  
file name prefix is "videorecord",  
and adding date and time suffix to file name

**The record storage is**  
uploading to NAS  
Total space: 153613496 byte(s)  
Used space: 0 byte(s)  
Free space: 82745952 byte(s)

NAS parameters list as following:  
Network storage location is "///192.168.200.134/SAMBA"  
Workgroup is "Test"  
User name is "Test"

Setup

### Schedule mode

- (1) **“Every day”** Enable/Disable every day application.
- (2) **“Week day”** Enable/Disable week day application.
- (3) **“Selected day”** Enable/Disable selected day application.

### Schedule information

- (1) Enter the **“Start time”** and **“Stop time”** for day mode.  
Note that the time format is [hh:mm] and is expressed in 24-hour clock time. By default, the start and end time of day mode are set to 01:00:00 and 23:59:59.

(2) **“Sun”/“Mon”/“Tue”/“Wed”/“Thu”/“Fri”/“Sat”** Select the days of the week to perform the application.

(3) **“Start day”** and **“Start time”** as the start timing the time. **“End day”** and **“End time”** as the end timing the time

(4) **“Enable cyclic recording”** The cyclic recording function is enabled, during the transaction stage when a storage space is full and the incoming streaming data is about to overwrite the previously saved videos.

### Record parameters

(1) **Source**: Select a stream for the recording source.

(2) **Recording interval**: Select the recording time interval.

(3) **Prefix file name**: You can setting the file name, and enable or disable to add the date and time on file name.

**Response mode** There are two choices of server types available: NAS, Micro SD Card. Select the item to display the detailed configuration options.

#### (1) **“NAS”**

--**“NAS server address”** Enter IP address of the NAS server.

--**“NAS shared directory”** Enter the NAS shared directory path.

--**“Workgroup”** Enter the NAS workgroup parameter.

--**“User account”** Enter the login name of the NAS account.

--**“User password”** Enter the password of the NAS account.

**Note:** Video record with the Application must be set to the same shared directory path. If you would like do detail recording settings or multi-channel recording, please install bundled 64CH recording software in CD.

# Stream

Stream  
1.0.2.13

- ▶ Home
- ▶ System
- ▶ User management
- ▶ Network
- ▶ Access list
- ▶ Audio and video
- ▶ Video record
- ▶ Stream
- ▶ Camera control
- ▶ Application
- ▶ Storage
- ▶ System log
- ▶ Status and parameters
- ▶ Maintenance

**Audio codec setting**

**Audio codec is**  
AAC,  
and bit rate is 32Kbps

**Video codec setting**

**Stream 1 video codec is**  
H.264,  
video size is 1920x1080,  
connection is from local,  
maximum frame rate is 15,  
video quality is "fixed quality" and value is 11,  
and intra frame period is 30

**Stream 2 video codec is**  
H.264,  
video size is 1280x1024,  
connection is from local,  
maximum frame rate is 20,  
video quality is "fixed quality" and value is 12,  
and intra frame period is 30

**Snapshot and time display setting**

**Snapshot resolution is**  
640x480  
and add time and date on the picture/stream

## Audio codec setting

(1) **“Audio codec type”** There are two choices of audio codec types available: **“AMR”**、**“AAC”** and **“G.711”**.

(2) **“Bit rate”**

-- **“AMR”** The bit rates are selectable at the following rates: 4.75Kbps,5.15 Kbps,5.9 Kbps,6.7 Kbps,7.4 Kbps,7.95 Kbps,10.2 Kbps and 12.2 Kbps.

-- **“AAC”** The bit rates are selectable at the following rates: 8Kbps,16Kbps, 24Kbps and 32Kbps.

-- **“G.711”** pcmu and pcma.

### Video codec setting

- (1) **“Select Stream”** The Network Camera supports **“Stream 1”** and **“Stream 2”**.
- (2) **“Video codec”** The Network Camera supports three kind of video compression mode: **“H.264”** or **“MPEG4”** or **“MJPEG”**. User can choose one of these compression modes based on requirement or application
- (3) **“Video size”** Click the down arrow to choose the quality of image
- (4) **“Connection type”** User can select this button to choose the better video & links quality. (Internet mode or Intranet mode)
- (5) **“Frame rate”** This limits the maximal refresh frame rate per second. Set the frame rate higher for a smoother video quality.
- (6) **“Intra frame period”** Determine how often to plant an “I frame”. The shorter the duration, the more likely you will get a better video quality, but at the cost of higher network bandwidth consumption.
- (7) **“Video Quality type”** Setting optimizes bandwidth utilization and video quality.
  - **“Constant bit rate”** User can adjust the video quality from 20 Kbps to 12 Mbps.
  - **“Fixed quality”** user can select from lowest quality to get best quality according. The “Quality” are selectable at the following rates: From 1 to 20.

### Snapshot and time display setting

Adjust the photo size specifications and choose whether to mark time on the video and photo.

## Camera control(PTZ model only)

Camera control 1.0.2.13

- ▶ Home
- ▶ System
- ▶ User management
- ▶ Network
- ▶ Access list
- ▶ Audio and video
- ▶ Video record
- ▶ Stream
- ▶ Camera control
- ▶ Application
- ▶ Storage
- ▶ System log
- ▶ Status and parameters
- ▶ Maintenance

**Camera control**



|      |       |       |
|------|-------|-------|
| UL   | Up    | UR    |
| Left | Home  | Right |
| LL   | Down  | LR    |
| -    | Zoom  | +     |
| -    | Focus | +     |
| -    | Iris  | +     |

Zoom times display
   

|                |                                 |              |                                |
|----------------|---------------------------------|--------------|--------------------------------|
| Pan speed      | <input type="text" value="3"/>  | Tilt speed   | <input type="text" value="3"/> |
| Zoom Step      | <input type="text" value="1"/>  | Focus Step   | <input type="text" value="4"/> |
| Auto pan speed | <input type="text" value="3"/>  |              |                                |
| Patrol cycle   | <input type="text" value="30"/> | Patrol speed | <input type="text" value="3"/> |

**Preset point setting**

The current home position is  
default

The current auto pan range is  
default

The preset points list as following:  
none

### Camera control

The pan and tilt functions can be controlled with these buttons. The “**Left**” button controls the camera to the left; the “**Right**”, “**Up**”, and “**Down**” buttons control the camera accordingly.

(1) “**UL**”, “**UR**”, “**LL**” and “**LR**” buttons control the camera to an oblique angle. And “**Home**” button controls the camera to the center.

(2) “**Pan angle**” This sets the range of the horizontal movement of the camera. The larger value is setting, the larger movement of “**Left**” or “**Right**” is performing by the camera.

(3) “**Tilt angle**” This sets the range of the vertical movement of the camera. The larger value is setting, the larger movement of “**Up**” or “**Down**” is performing by the

48/66



camera.

**(4) "Patrol cycle"** It is the cycle of patrol function.

**(5) "Auto pan speed"** This defines the speed of auto panning. The larger value is setting, the faster speed will run by the camera.

**(6) "Auto patrol speed"** This defines the speed of auto patrol. The larger value is setting, the faster speed will run by the camera.

### Preset point setting

**(1) "Set the home position"**

--**"Set default value as home position"** Restore home position to original default's home by clicking on this button.

--**"Set the current position as home position"** Click on the button will set the current aimed position as home of the Network Camera. Each time the Network Camera reboots or finishes calibration, it will automatically aim to the defined home position

**(2) "Set the auto pan range"**

--**"Set default value as auto pan range"** Restore auto pan range to original default's auto pan range by clicking on this button.

--**"Set the auto pan range manually"** Click on the button will set the auto pan range of the Network Camera.

**(3) "Add or delete a preset point"**

--**"Add current point as a preset point"** If the User wants to save the current view as a preset location, enter a name to each of the current video view on **"Preset points"** and click on the **"Finish"** button. The camera allows for 20 preset locations.

--**"Delete a preset point from below"** This keeps a list for preset positions. Clicking on the **"Finish"** button will remove the current selected position from the preset list.

### Patrol list setting

**(1) "Preset points"** The preset points box list all preset points. User must use to drag the preset points to **"Patrol list"** box when the action is recognized the **"Patrol list"** box change to red.

**(2) "Patrol list"** The Patrol list box list all patrol points. User use the drag to adjust of the patrol point(Up or down). **Dwelling time (sec)"** The stop time of each preset location during auto patrols of the Network Camera.

**(3) "Remove patrol point"** The remove patrol point box will remove the patrol point.

# Application

## Schedule mode

- (1) **“Every day”** Enable/Disable every day application.
- (2) **“Week day”** Enable/Disable week day application.
- (3) **“Selected day”** Enable/Disable selected day application.

## Schedule information

- (1) Enter the **“Start time”** and **“Stop time”** for day mode.  
 Note that the time format is [hh:mm:ss] and is expressed in 24-hour clock time. By default, the start and end time of day mode are set to 01:00:00 and 23:59:59.
- (2) **“Sun”/“Mon”/“Tue”/“Wed”/“Thu”/“Fri”/“Sat”** Select the days of the

week to perform the application.

- (3) **“Start day”** and **“Start time”** as the start timing the time. **“End day”** and **“End time”** as the end timing the time

### Trigger mode

- (1) **“Video motion detection”** Enable/Disable video motion application
- (2) **“Periodically”** This option allows the Network Camera to trigger periodically for every other defined minute.
- (3) **“Video Tracking”** is able to track dynamic objects within screen video.
  - **“Tracking level”** 1 to 5 level the lower the number the more sensitive.

### parameters

- (1) **“Motion parameters”**
  - Higher sensitivity and small threshold will allow easier motion detection.
- (2) **“Period parameters”** This option allows the Network Camera to trigger periodically for every other defined seconds. Up to 999 seconds are allowed.

### Media mode

There are four choices of media types available: **“Snapshot”**, **“Message”**, **“Record(Motion Detection only)”** and **“System log”**.

#### Snapshot & Record file setting

You can setting the file name, and enable or disable to add the date and time on file name.

### Response mode

There are four choices of server types available: Email, FTP, NAS, and SD Card storage. Select the item to display the detailed configuration options.

#### (1)“Email”

- **“Email security mode”** : If your SMTP server requires a secure connection (SSL or TLS), check This server requires a secure connection (SSL or TLS).
- **“Sender email”** address: Enter the email address of the sender.
- **“Recipient email”** address: Enter the email address of the recipient.
- **“Server address”** Enter the domain name or IP address of the email server.
- “User name”** Enter the user name of the email account if necessary.
- “Password”** Enter the password of the email account if necessary
- “Server port”** The default mail server port is set to 25. You can also manually set another port.

#### (2)“FTP”

- **“Server address”** Enter the domain name or IP address of the FTP server.
- **“Server port”** By default, the FTP server port is set to 21.
- **“User name”** Enter the login name of the FTP account
- **“Password”** Enter the password of the FTP account.
- **“FTP folder name”** Enter the folder where the media file will be placed. If the folder name does not exist, the Network Camera will create one on the FTP server.

#### (3)“HTTP ”

- **“URL”** Enter the URL of the HTTP server.
- **“User account”** Enter the user name if necessary.

- "**User password**" Enter the password if necessary.
- (4) "**NAS**"
  - "**NAS server address**" Enter IP address of the NAS server.
  - "**NAS shared directory**" Enter the NAS shared directory path.
  - "**Workgroup**" Enter the NAS workgroup parameter.
  - "**User account**" Enter the login name of the NAS account
  - "**User password**" Enter the password of the NAS account.

Note: Video record with the Application must be set to the same shared directory path. If you would like to do detail recording settings or multi-channel recording, please install bundled 64CH recording software in CD.

# Storage

Manage the storage device.

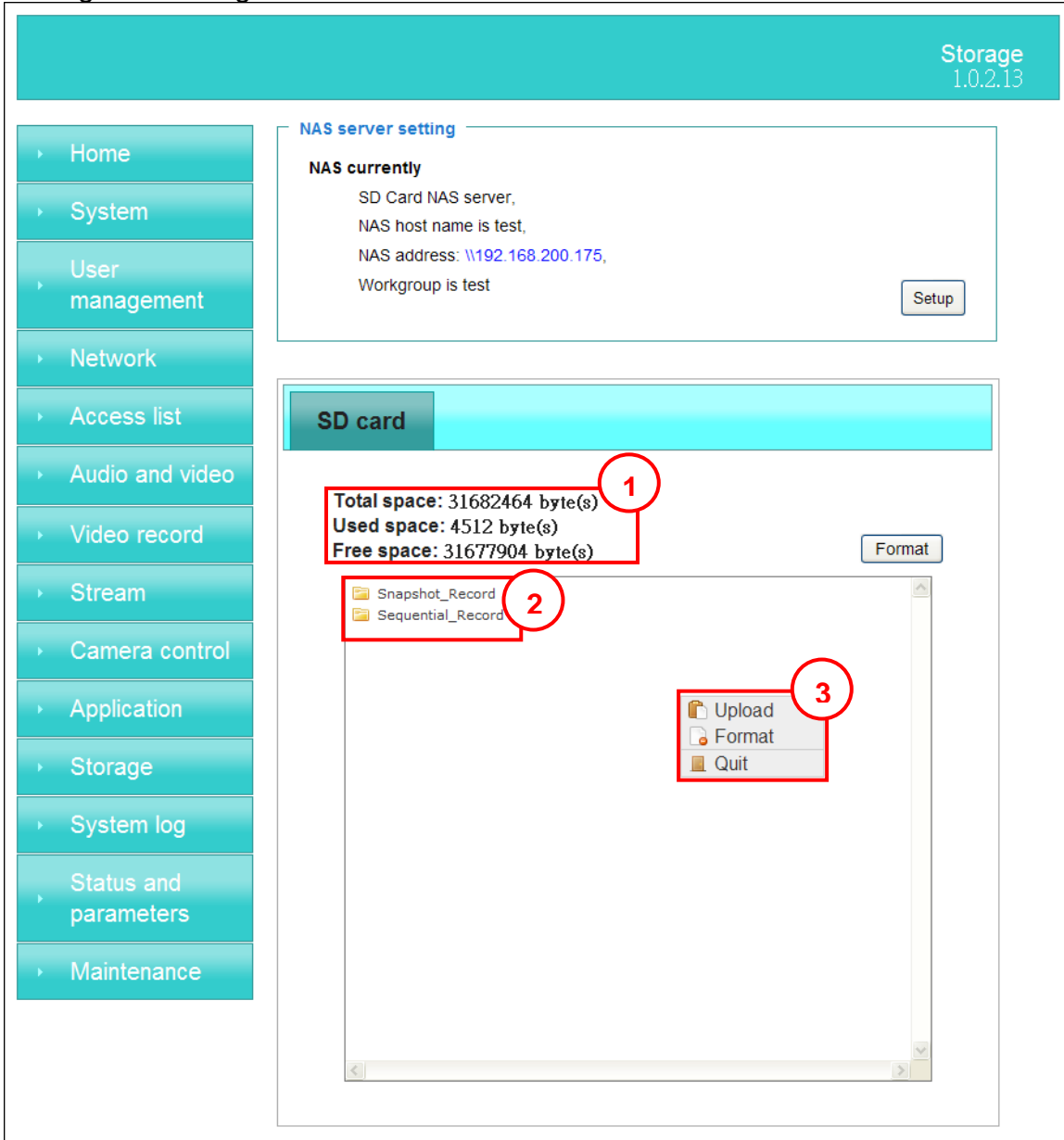

## Storage Status

Here show the storage device information.

## NAS server setting

- (1) **“NAS Host name”** Choose and input the NAS Host name of this camera.
- (2) **“Workgroup”** Input the name of Workgroup. You can see the NAS Host name you input in the same workgroup with your PC. Then you can connect to this device and download the files easily from SD card which is inserted to this

camera.

### **File operation**

Move the mouse over the file. Press the mouse right button that Right-click menu is displayed. You can delete files.

Move the mouse over the directory. Press the mouse left button that the file structure expand. Press the mouse right button that Right-click menu is displayed. You can choose upload or delete files.

**NOTE** : Allow the user to upload or delete files when the storage device is not write-protected. If the SD card can't be detected, please link to the following URL:

<http://www.sdcard.org/consumers/formatter> to download the "SD Formatter Kit" formatting your SD card.

# Syslog

System log  
1.0.2.13

- ▶ Home
- ▶ System
- ▶ User management
- ▶ Network
- ▶ Access list
- ▶ Audio and video
- ▶ Video record
- ▶ Stream
- ▶ Camera control
- ▶ Application
- ▶ Storage
- ▶ System log
- ▶ Status and parameters
- ▶ Maintenance

**Remote log setting**

**Remote log server**  
Disable

**Current log**

```

Nov 2 10:28:45 PTCam18M syslog: External port:8091 TCP is redirected to Internal
192.168.200.108:80
Nov 2 10:28:46 PTCam18M syslog: External port:5364 UDP is redirected to Internal
192.168.200.135:54
Nov 2 10:28:47 PTCam18M syslog: External Rtsip_port is upgrade.
Nov 2 10:28:47 PTCam18M syslog: External port:3562 TCP is redirected to Internal
192.168.200.110:554
Nov 2 10:28:48 PTCam18M syslog: External SSL_port is upgrade.
Nov 2 10:28:48 PTCam18M syslog: External port:4442 TCP is redirected to Internal
192.168.200.110:443
Nov 2 10:28:52 PTCam18M stunnel: LOG4[1930:1024]: Wrong permissions
on /etc/conf.d/ssl/certificate.pem
Nov 2 10:28:52 PTCam18M stunnel: LOG5[1930:1024]: stunnel 4.26 on arm-unknown-
linux-gnu with OpenSSL 0.9.8i 15 Sep 2008
Nov 2 10:28:52 PTCam18M stunnel: LOG5[1930:1024]: stunnel 4.26 on arm-unknown-
linux-gnu with OpenSSL 0.9.8i 15 Sep 2008
Nov 2 10:28:52 PTCam18M stunnel: LOG5[1930:1024]: Threading:PTHREAD
SSL:ENGINE Sockets:POLL,IPv6
Nov 2 10:28:52 PTCam18M stunnel: LOG5[1930:1024]: 500 clients allowed
Nov 2 12:37:46 PTCam18M mDNSResponder: ERROR: getOptRdata - unknown opt 4
Nov 2 12:38:17 PTCam18M last message repeated 5 times
Nov 2 13:14:21 PTCam18M mDNSResponder: ERROR: getOptRdata - unknown opt 4
Nov 2 13:20:43 PTCam18M last message repeated 6 times
Nov 2 13:21:51 PTCam18M last message repeated 6 times
Nov 2 13:24:09 PTCam18M last message repeated 6 times
Nov 2 13:29:00 PTCam18M last message repeated 6 times
Nov 2 13:29:31 PTCam18M last message repeated 5 times
Nov 2 13:50:23 PTCam18M syslog: [DIDO] Reload configure file
56
                
```

The Network camera supports log the system messages on remote server. The protocol is compliant to RFC 3164. If you have external Linux server with sys log service, use “-r” option to turn on the facility for receiving log from remote machine. Or you can use some software on Windows that is compliant to RFC 3164. An example is Kiwi Syslog Daemon. Visit <http://www.kiwisyslog.com/kiwi-syslog-daemon-overview/>. Check “**Setup**” and “**Enable**” then input the “**IP address**” and “**port**” number of the log server to enable the remote log facility. In the “**Current log**”, it displays the current system log file. The content of the log provides useful information about configuration and connection after system boot- up. “**finish**” Click on this button to save modify settings.

## Status and Parameters

User can find a lot of information about the system such as “**Upnp port forwarding**”, “**Traversing NAT**”, “**Public IP**”, and so on. User also can get the number of current viewer of the Network Camera here.

Status and parameters  
1.0.2.13

- ▶ Home
- ▶ System
- ▶ User management
- ▶ Network
- ▶ Access list
- ▶ Audio and video
- ▶ Video record
- ▶ Stream
- ▶ Camera control
- ▶ Application
- ▶ Storage
- ▶ System log
- ▶ Status and parameters
- ▶ Maintenance

**Status**

**Upnp port forwarding**  
Success

**Traversing NAT**  
Success

**Public ip**  
114.25.22.102:8091

**Current viewers**  
0

**Parameters**

```
[System parameters]
hostName="Network Pan/Tilt Camera";
enableLed=true;
timeZone=80;
supportAutoDST=false;
enableDST=false;
timeMethod=0;
ntpServer="time.stdtime.gov.tw";
updateInterval=1;
doActState=false;
diActState="high";
doCurState=true;
diCurState="low";
doState="false";
connection=false;
doState=false;
connection=false;
nu_Fw=0;

[Network parameters]
networkType="lan";
```



# Maintenance

Maintenance  
1.0.2.13

- ▶ Home
- ▶ System
- ▶ User management
- ▶ Network
- ▶ Access list
- ▶ Audio and video
- ▶ Video record
- ▶ Stream
- ▶ Camera control
- ▶ Application
- ▶ Storage
- ▶ System log
- ▶ Status and parameters
- ▶ Maintenance

**Reboot system**

Use the button to reboot the system Reboot

**Restore system**

Restore all settings to factory default except settings in

Network type  Root password Restore

**Calibrate camera**

Recalibrate the home position to the default center to recover the tolerance caused by some external forces Calibrate

Recalibrate the autofocus position to the default range to recover the tolerance caused by some external forces Calibrate

**Export/Import file**

Export setting backup file Export

Import setting backup file  浏览... Import

**Upgrade firmware**

Select a file to upgrade  浏览... Upgrade

**1. “Reboot system”** The **“Reboot”** button will reboot the Network Camera. It's useful while the Network Camera got problem.

**2. “Restore system”** Click on **“Restore”** button on the configuration page to restore the factory default settings. Restore all settings to factory default except settings in “Network type ” and “Root Password”. The system will restart and require the installer program to set up the network again.

### **3. “Export/Import file”**

-- Export setting backup file: Click to export all parameters for the device and user-defined scripts.

-- Upload setting backup file: Click Browse... to upload a setting backup file. Please note that the model and firmware version of the device should be the same as the setting

backup file. If you have set up a fixed IP or other special settings for your device, it is not suggested to upload a settings backup file.

**4. "Upgrade firmware"** Select the firmware file and click upgrade button. Please be aware that you should not turn off the power during updating the firmware and wait for finish message.

***Warning:*** *The upgrade firmware procedure cannot be interrupted. If the power and/or network connection are broken during the procedure, it might possibly cause serious damage to the Network Camera.*

**Note:** When upgrade firmware please wait for 210~360 seconds, and then you can connect to Network Camera again. The system will restart and require the installer program to set up the network again.

## Appendix

### A. Troubleshooting & Frequently Asked Questions

#### Q1: Status led does not light up.

A1: First, make sure that 「 Configuration>System>Turn off the LED indicator 」 is disabled. If it is, check the item, and the led should light up. Second, if red led does not light up, please check that the power adapter in the package is plugged correctly. And last, if green led does not light up; please check that category 5 UTP cable is plugged correctly. If the problem is still not solved, please contact your dealer for further help.

#### Q2: What kind of Ethernet cable is used by network camera?

A2: The network Camera uses Category 5 UTP cable allowing 10 and/or 100 Base-T networking.

#### Q3: The Network Camera will be installed and work if a firewall exists on the network?

A3: There are two way to set up the IP camera at Internet.

(1) By UPnP Port Forwarding

1. Select an IP router. It must support UPnP port forwarding and enable this function first!!

##### UPnP Settings

You can setup this item if you want to enable UPnP.

Enabled  Disabled

2. Connect camera RJ45 cable to IP router and the router is also connected to Internet.

3. Plug power cord to camera.

4. Go to camera Network page. Enable UPnP port forwarding

##### Network setting

Please enable or disable UPnP port forwarding

Enable

Disable

Cancel

Prev

Next

Finish

5. Check camera status, we can see the ports had been successfully opened!

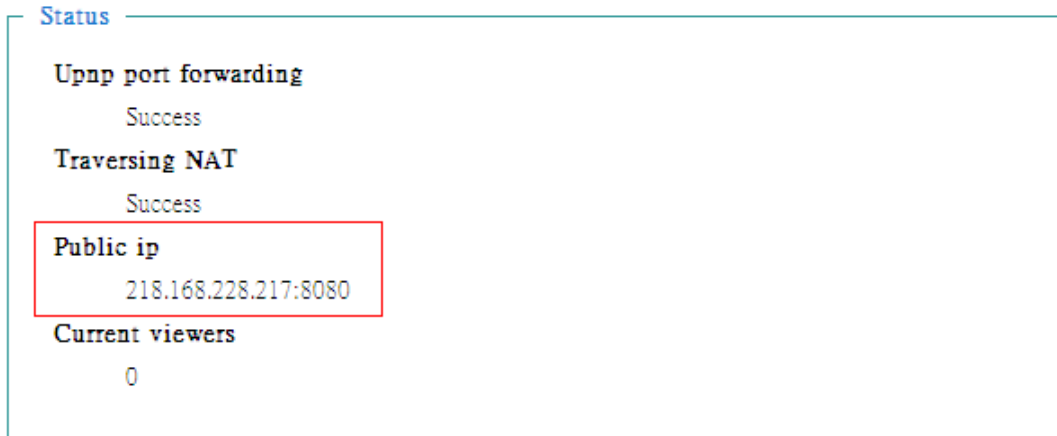

6.Type IP address:8080 at browser. Then you can see camera through Internet.

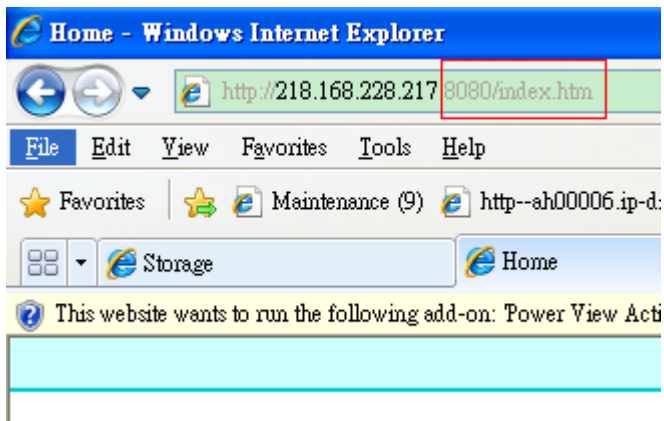



































7.You can also type the ddns name at below label of camera on browser URL field. For example, you may type ah00001.ip-discovery.com:8080.

## (2) By Setting Port Forwarding Manually

1. Select a router. Set the port forwarding as following.

Virtual Server Lists 17 / 32 (Number / Total)

| Name                                           | Private IP    | Protocol        | Schedule |                                                                                                                                                                         |
|------------------------------------------------|---------------|-----------------|----------|-------------------------------------------------------------------------------------------------------------------------------------------------------------------------|
| <input type="checkbox"/> Virtual Server FTP    | 0.0.0.0       | TCP 21/21       | Always   |   |
| <input type="checkbox"/> Virtual Server HTTP   | 0.0.0.0       | TCP 80/80       | Always   |   |
| <input checked="" type="checkbox"/> PTCam      | 192.168.0.100 | TCP 443/443     | Always   |   |
| <input type="checkbox"/> Virtual Server DNS    | 0.0.0.0       | UDP 53/53       | Always   |   |
| <input type="checkbox"/> Virtual Server SMTP   | 0.0.0.0       | TCP 25/25       | Always   |   |
| <input type="checkbox"/> Virtual Server POP3   | 0.0.0.0       | TCP 110/110     | Always   |   |
| <input type="checkbox"/> Virtual Server Telnet | 0.0.0.0       | TCP 23/23       | Always   |   |
| <input type="checkbox"/> IPSec                 | 0.0.0.0       | UDP 500/500     | Always   |   |
| <input type="checkbox"/> PPTP                  | 0.0.0.0       | TCP 1723/1723   | Always   |   |
| <input type="checkbox"/> NetMeeting            | 0.0.0.0       | TCP 1720/1720   | Always   |   |
| <input type="checkbox"/> DCS-1000              | 0.0.0.0       | TCP 80/80       | Always   |   |
| <input type="checkbox"/> DCS-2000              | 0.0.0.0       | TCP 80/80       | Always   |   |
| <input type="checkbox"/> DVC-1000              | 0.0.0.0       | TCP 1720/1720   | Always   |   |
| <input checked="" type="checkbox"/> PTCarr     | 192.168.0.100 | TCP 80/80       | Always   |   |
| <input checked="" type="checkbox"/> PTCam      | 192.168.0.100 | UDP 53/53       | Always   |   |
| <input checked="" type="checkbox"/> PTCam      | 192.168.0.100 | TCP 554/554     | Always   |   |
| <input checked="" type="checkbox"/> 28067      | 192.168.0.102 | TCP 28067/28067 | Always   |   |

PS. Port 80 is HTTP Port, port 53 is stream port, port 554 is RTSP port. and port 443 is HTTPS port.

2.Go to camera Network page. Disable UPnP port forwarding function.

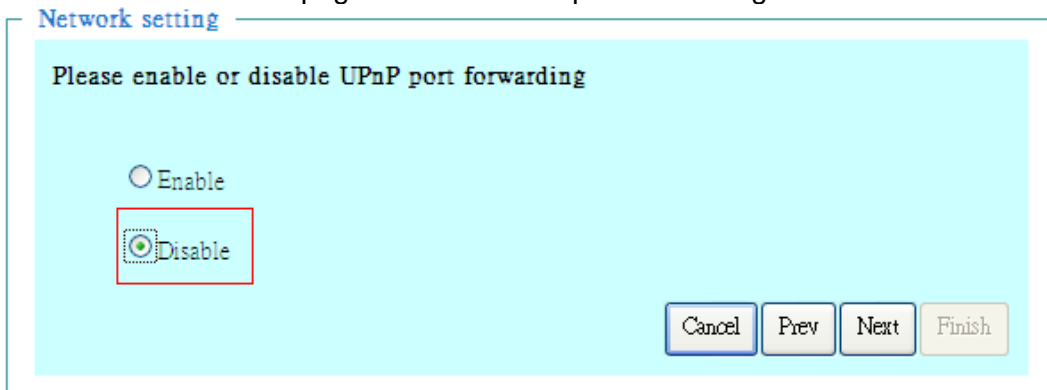

**Network setting**

Please input the port parameters

|                 |                                  |
|-----------------|----------------------------------|
| HTTP port       | <input type="text" value="80"/>  |
| HTTPS port      | <input type="text" value="443"/> |
| RTSP port       | <input type="text" value="554"/> |
| Video RTP port  | <input type="text" value="54"/>  |
| Video RTCP port | <input type="text" value="55"/>  |
| Audio RTP port  | <input type="text" value="56"/>  |
| Audio RTCP port | <input type="text" value="57"/>  |

3. Type IP address at browser. Then you can see camera through Internet.
4. You can also type the ddns name at below label of camera on browser URL field. For example, you may type ah00001.ip-discovery.com.

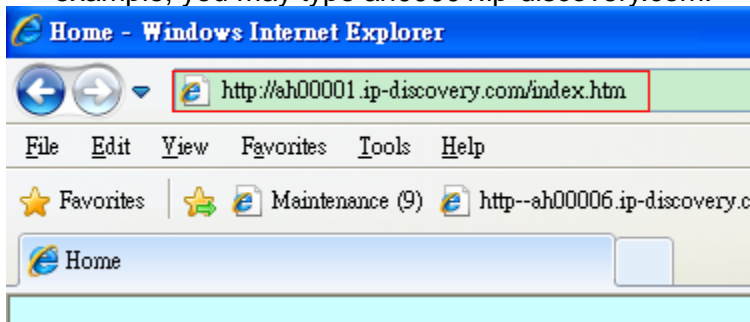

**Note:** The firewall software at PC may block the transfer of network camera. Please remove or stop the kind software.

**Q4: How can I find the network camera in the local area network?**

A4: By using the IP Finder2 program or using UPnP to find it.

**Q5: IP Finder2 program cannot find Network Camera in the local area network at first time?**

A5: Make sure the subnet of network camera is same as your PC. If the local area network supports DHCP, the camera is "Get IP address automatically" in the "Network" page default. If the local area network does not support DHCP, change your PC IP address to "192.168.0.xxx".

**Q6: How can I restore the network camera to default value?**

A6: Use a gem clip to press on the inside button. Network camera begins to restore

default value. You can also press the button **“Factory”** in “Maintenance” page to restore the default value.



**Q7: I cannot play the recorded video file.**

A7: Install the audio codec in the CD, and use the Windows Media Player 10 or later to play the \*.ASF or \*.AVI file recorded by the network camera.

**Q8: Infrared led does not light up?**

A8: Check 「 Configuration>Audio and Video>Infrared LED Control 」 is **“Auto”** or **“Manual》 Turn on”**.

**Q9: The network camera cannot focus accurately.**

A9:

(1) The lens is dirty or dust is attached. Clean the lens with lens cleaner. And then adjust the camera focus manually.

(2) The image may be out of focus. If the object is too near, move the object away from Network Camera.

**Q10: The cover of network camera is warm. Is it normal?**

A10: Network camera is a precision device. The internal material has the operational temperature, and it is normal when user touch the cover feels warm. It is recommended to put the network camera at aired place, and not put at any other device.

**Q11: What is the scope of wireless network camera connecting AP?**

A11: The scope of wireless connection is different form the environment. The possible interference is (1) the direction of antenna (2) the material and architecture of building (3) the temperature of environment (4) the position of the network camera.

**Q12: The process of upgrade firmware abort.**

A12: Contact your dealer for further help.

**Q13: Cannot access the login page and other web pages of Network Camera from Internet Explorer**

A13:

- May be due to the network cable. Try correcting your network cable and configuration. Test the network interface by connecting a local computer to the Network Camera via a crossover cable.
- Make sure the Internet connection and setting is ok.
- Make sure enter the IP address of Internet Explorer is correct. If Network Camera has a dynamic address, it may have changed since you last checked it.
- Network congestion may prevent the web page appearing quickly. Wait for a while. The IP address and Subnet Mask of the PC and Network Camera must be in the same class of the private IP address on the LAN.
- Make sure the http port used by the Network Camera, default=80, is forward to the Network Camera's private IP address.
- The port number assigned in your Network Camera might not be available via Internet. Check your ISP for available port.
- The proxy server may prevent you from connecting directly to Network Camera, set up not to use the proxy server.
- Confirm that Default Gateway address is correct.
- The router needs Port Forwarding feature. Refer to your router's manual for details.
- Packet Filtering of the router may prohibit access from an external network. Refer to your router's manual for details.
- Access Network Camera from the Internet with the global IP address of the router and port number of Network Camera.
- Some routers reject the global IP address to access Network Camera on the same LAN. Access with the private IP address and correct port number of Network Camera.
- When you use DDNS, you need to set Default Gateway and DNS server address.
- If it's not working after above procedure, reset Network Camera to default setting and installed it again.
- Maybe the IP Address of the Network Camera is already being used by another device or computer.
- If the problem is not solved, the Network Camera might be faulty. Contact your dealer for further help.



## B. Technical specifications

|                                                                                                                                                                                                   |                                                                                                                                                                                                               |
|---------------------------------------------------------------------------------------------------------------------------------------------------------------------------------------------------|---------------------------------------------------------------------------------------------------------------------------------------------------------------------------------------------------------------|
| <p><b>- System</b><br/>RAM : 4GB DDR<br/>ROM : 16MB flash ROM</p>                                                                                                                                 | <p><b>- Camera specification</b><br/>Type 1/2.8 Sony CMOS sensor IMX222<br/>Resolution: 1920x1080</p>                                                                                                         |
| <p><b>- IR Led</b><br/>Auto/Manual mode, 15~20M visible<br/>Spectral band width 42nm, Peak emission wavelength 850nm<br/>Daylight sensor, angle +/-65, wave length 400~700nm</p>                  | <p><b>- Lens</b><br/>3X optical zoom lens, auto iris, auto focus<br/>f = 3mm ~ 9mm, F1.8<br/>Fov(D), 136° ~ 39°</p>                                                                                           |
| <p><b>- Protocol</b><br/>TCP/IP, HTTP, SMTP, FTP, DDNS, UPnP, Telnet, NTP, PPPoE, DNS, DHCP and RTSP</p>                                                                                          | <p><b>- Video Resolution</b><br/>Up to 30 frames at 1920*1080, 1280x1024, 1280x800, 640x480, 320x240 and 176x144<br/><b>- Audio</b><br/>G.711/AMR/AAC,Omni-directional Microphone<br/>Support 2 way audio</p> |
| <p><b>- Algorithm supported</b><br/>H.264/MPEG4/MJPEG multi-codec for streaming video<br/>JPEG for still image<br/><b>- Physical</b><br/>10 baseT or 100 baseT Fast Ethernet auto negotiation</p> | <p><b>- I/O Interface</b><br/>RJ-45<br/>DI<br/>DO<br/>Audio in<br/>Audio out<br/>DC Power<br/>Micro SD slot(inside camera)</p>                                                                                |
| <p><b>- Pan/Tilt angle</b><br/>Support auto tracking function<br/>Support multi - direction movement<br/>Pan : 250°<br/>Tilt : 75°</p>                                                            | <p><b>- Power</b><br/>Input: 100-240VAC, 50/60Hz, 0.7A<br/>Output: 12VDC, 1.5A<br/>Consumption: Max 8 W<br/>Support 802.3af compliant Power over Ethernet</p>                                                 |
| <p><b>- EMI &amp; Safety</b><br/>CE, FCC</p>                                                                                                                                                      | <p><b>- Dimension</b><br/>Height : 69mm, Diameter : 92mm</p>                                                                                                                                                  |
| <p><b>- Operating Environment</b><br/>Temperature : 0 ~ 40°C<br/>Humidity : 85% RH</p>                                                                                                            | <p><b>- Weight</b><br/>NET. 380g(PTZ model)<br/>NET. 370g(Fixed model)</p>                                                                                                                                    |

# Notification of Compliance

Appendix C

---

## Europe - EU Declaration of Conformity



For complete DoC please visit

<http://global.level1.com/downloads.php?action=init>

## GPL License Agreement

GPL may be included in this product, to view the GPL license agreement goes to

<http://download.level1.com/level1/gpl/GPL.pdf>

For GNU General Public License (GPL) related information, please visit

<http://global.level1.com/downloads.php?action=init>