

Warning: Keep ventilation openings, in the appliance enclosure or in the built-in structure, clear of obstruction.  
Do not use mechanical devices or other means to accelerate the defrosting process, other than those recommended by the manufacturer.  
Do not damage the refrigerant circuit.  
Do not use electrical appliance inside the food storage compartments of the appliance, unless they are of the type recommended by the manufacturer.

This appliance is not intended for use by persons(including children)with reduced physical, sensory or mental capabilities, or lack of experience and knowledge, unless they have been given supervision or instruction concerning use of the appliance by a person responsible for their safety.

If the supply cord is damaged, it must be replaced by a special cord or assembly available from the manufacturer or its service agent.

Children should be supervised to ensure that they do not play with the appliance.

# LABIRENT

## REFRIGERATOR

### INSTRUCTION MANUAL

Model:SL-55



Read this booklet thoroughly before operating the unit and keep it in a safe place for future reference.

## 1.Name of parts

### PARTS AND FEATURES

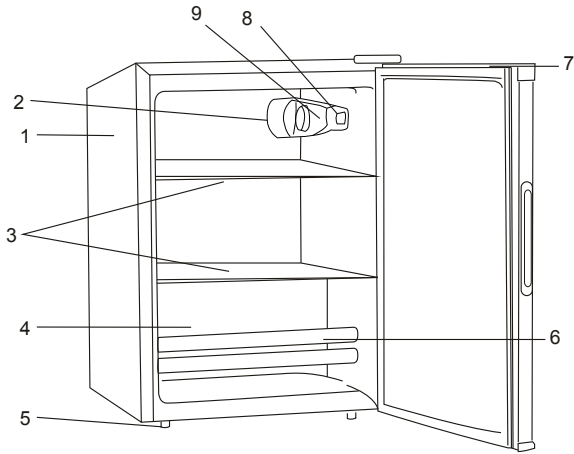

- |                  |                             |
|------------------|-----------------------------|
| 1. Cabinet       | 6. Article file             |
| 2. Lamp          | 7. Recessed Handle          |
| 3. Drip Tray     | 8. Door switch              |
| 4. Crisper box   | 9. Temperature Control Knob |
| 5. Leveling legs |                             |

Warning: Keep ventilation openings, in the appliance enclosure or in the built-in structure, clear of obstruction.

Do not use mechanical devices or other means to accelerate the defrosting process, other than those recommended by the manufacturer.

Do not damage the refrigerant circuit.

Do not use electrical appliance inside the food storage compartments of the appliance, unless they are of the type recommended by the manufacturer.

This appliance is not intended for use by persons (including children) with reduced physical, sensory or mental capabilities, or lack of experience and knowledge, unless they have been given supervision or instruction concerning use of the appliance by a person responsible for their safety.

If the supply cord is damaged, it must be replaced by a special cord or assembly available from the manufacturer or its service agent.

Children should be supervised to ensure that they do not play with the appliance.

## 7. Technical specifications

\*For the detailed technical specifications, please refer to the nameplate at the back of the refrigerator..

\*Specifications are subject to change without prior notice.

**WARNING** Keep ventilation openings, in the appliance enclosure or in the built-in structure, clear of obstruction.

**WARNING** Do not use mechanical devices or other means to accelerate the defrosting process, other than those recommended by the manufacturer.

**WARNING** Do not damage the refrigerant circuit.

**WARNING** Do not use electrical appliances inside the food storage compartments of the appliance, unless they are of the type recommended by the manufacturer.

if the supply cord is damaged, it must be replaced by the manufacturer or its service agent or a similarly qualified person in order to avoid a hazard.

## 2. Correct positioning

### Ventilation

For easy heat dissipation, low power consumption and maximum efficiency, the refrigerator should be kept in a well ventilated area. There should be space of at least 100mm around the refrigerator and at least 200mm clear of the roof. There should be enough space to allow the door to open 160 degrees.

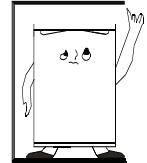

### Power Supply

The refrigerator is only applied with power supply of single phase alternating current of (220-240)V~/50Hz. If fluctuation of voltage in the district user is of so large that the voltage exceeds the above scope, for safety sake, be sure to apply a.c. automatic voltage regulator to the refrigerator. The refrigerator must employ a special power socket instead of common one with other electric appliances. Its plug must match the socket with ground wire.

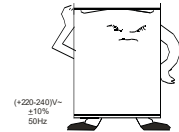

### Power Cord

The cord should never be lengthened or folded or allowed to coil during operation. The cord should never be kept close to the compressor or at the back of the refrigerator as the surface temperature is always high when operating. Any contact of the cord with the compressor could damage the insulation or cause leakage.

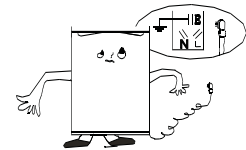

### Protection from Moisture

Avoid placing the unit in a wet or damp area as moisture would cause rust on metal parts. Never spray the unit directly with water as this would result in poor insulation and may cause current leakage.



### 3. Correctly Positioning

#### Protection from Heat

The refrigerator should be far away from any heat source or direct sunshine.



#### Fixing Stable

Floor on which refrigerator will be placed must be flat and solid. It should not be laid on any soft material such as foam plastic, etc. If the refrigerator is not on the same level, adjust the screws accordingly. The refrigerator should not be placed near anything which may echo.

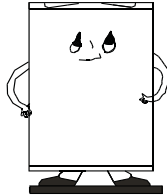

#### Keep Away from Danger

Do not place the refrigerator near any volatile or combustible elements like gas, petrol, alcohol, lacquer and banana oil. These should not be stored in the refrigerator at all.

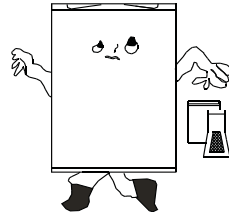

#### Moving

When fixed or moved, the refrigerator can not be set horizontally or declined to more than 45° or upside-down.

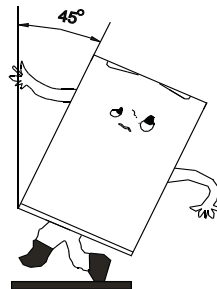

### 6. Troubleshooting

1. When the refrigerator does not work
  - Check if there is a power failure.
  - Check if the power plug is plugged into the power outlet.
  - Check that the fuse has not blown.
2. When the refrigerator is cooling excessively
  - The temperature control dial may be set too high.
  - If you place foodstuffs containing a lot of moisture directly under the cool air outlets, they will freeze easily. This does not indicate a malfunction.
3. When the refrigerator is not cooling sufficiently
  - The door may not have been closed properly.
  - The door gaskets may be damaged.
  - The temperature control dial may not be set properly.
  - To allow proper ventilation make sure there is enough space between the refrigerator and the surface, around the refrigerator as well as between the top of the refrigerator and the roof.
4. When the defrosting water overflows inside the refrigerator and onto the floor.
  - Check that the drain pipe and the drain hose are not clogged.
  - Check that the drain pan is housed properly.
5. When condensation form on the outside of the refrigerator.
  - Condensation may form on the outside when the humidity is high such as during a wet season. This is the same result as the condensation formed when chilled water is poured into a glass. It does not, therefore, indicate a failure, wipe dry with a dry cloth.
6. When you hear a sound like water flowing .
  - A sound like water flowing is the refrigerant flowing. It does not Indicate a malfunction.
7. When the cabinet's side panel heats up
  - The side panel of the cabinet will heat up when the door is opened or closed frequently, when starting the unit and when the unit operates in summer with high ambient outside temperature. In such case, do not touch the panel, it results from the dissipation of the heat from inside the cabinet, and it does not mean that something is wrong with the refrigerator.

## 5.Maintenance

- ★ The refrigerator should be cleaned and maintained once a month.
- ★ When performing maintenance, make sure that the power plug is first disconnected from the power outlet.
- ★ Wipe the inner and outer surface of the refrigerator and its accessories with wet cloth. If they are too dirty, scrub them with neutral detergent, and then clean them with water and dry them with clean cloth. After this, a small quantity of glass wax is recommended to polish the refrigerator surface with a flannelette.
- ★ For cleaning, don't use hot water, diluent, petrol, alcohol, kerosene, washing powder, cleanser, alkalinous detergent, acid, Chemical cloth, etc. So as not to damage the lacquer coat and plastics. It is forbidden than the refrigerator is directly sprayed with water. Otherwise, it would cause rusty or weaken the insulation.
- ★ Be careful to upkeep the sealing rubber bars of the doors. They should always be cleaned.
- ★ If the plastic parts in refrigerator remain contaminated for a long time by oil (animal or vegetable), they will be easy aged and possibly cracked. The drain pan gets dirty very easily if it is not cleaned regularly, bad odours will be produced, get into the habit of cleaning this pan regularly.

## 4.Cautions

- ★ Water contained in food or getting into air inside the refrigerator by opening doors may form a layer of frost inside. It will weaken the refrigerator when the frost is thick, while it is more than 2mm thick, you should defrost.
- ★ Defrosting in freezer chamber is operated manually. Before defrosting, take the food, the ice tray and the shelf out into the cold storing chamber temporarily then set the knob of the temperature regulator to position "0"(where the compressor will stop working) and leave the door open until ice and frost dissolve thoroughly deposited at the bottom drip tray of the freezer chamber. Take out the drip tray and discard the water carefully. In the case of speeding up the defrosting, you may put a bowl of warm water (about 50°C ) into the freezer chamber, and be sure to set the knob of the temperature regulator to original position after defrosting.
- ★ It is not advisable to heat the freezer chamber directly with hot water or hair dryer while defrosting to prevent deformation of the inner case.
- ★ Avoid using sharp objects to scrape the ice and frost as these may damage the inner casing or the surface of the evaporator.
- ★ If the supply cord of this appliance is damaged, it must only be replaced by a repair agent recommended by manufacture or store as special tools are required.