

物料号码	38.101.1098.019		
厂内型号	JM32DQI-165HZ	客户型号	
物料名称	说明书	日期	22/12/27
规格	GAM 客户 XXXXXXXXXXXXXXX (JM32DQI-165Hz) 说明书: VL468XCVEU 68257U 板菜单风格, 按设计图档文件要求制作 20221217		
材质	A5		
版本		设计	陈晓映
研发确认			
工程确认			
商务确认			

此页不印刷

32" RAIDER-165Hz QHD ULTRA GAMING

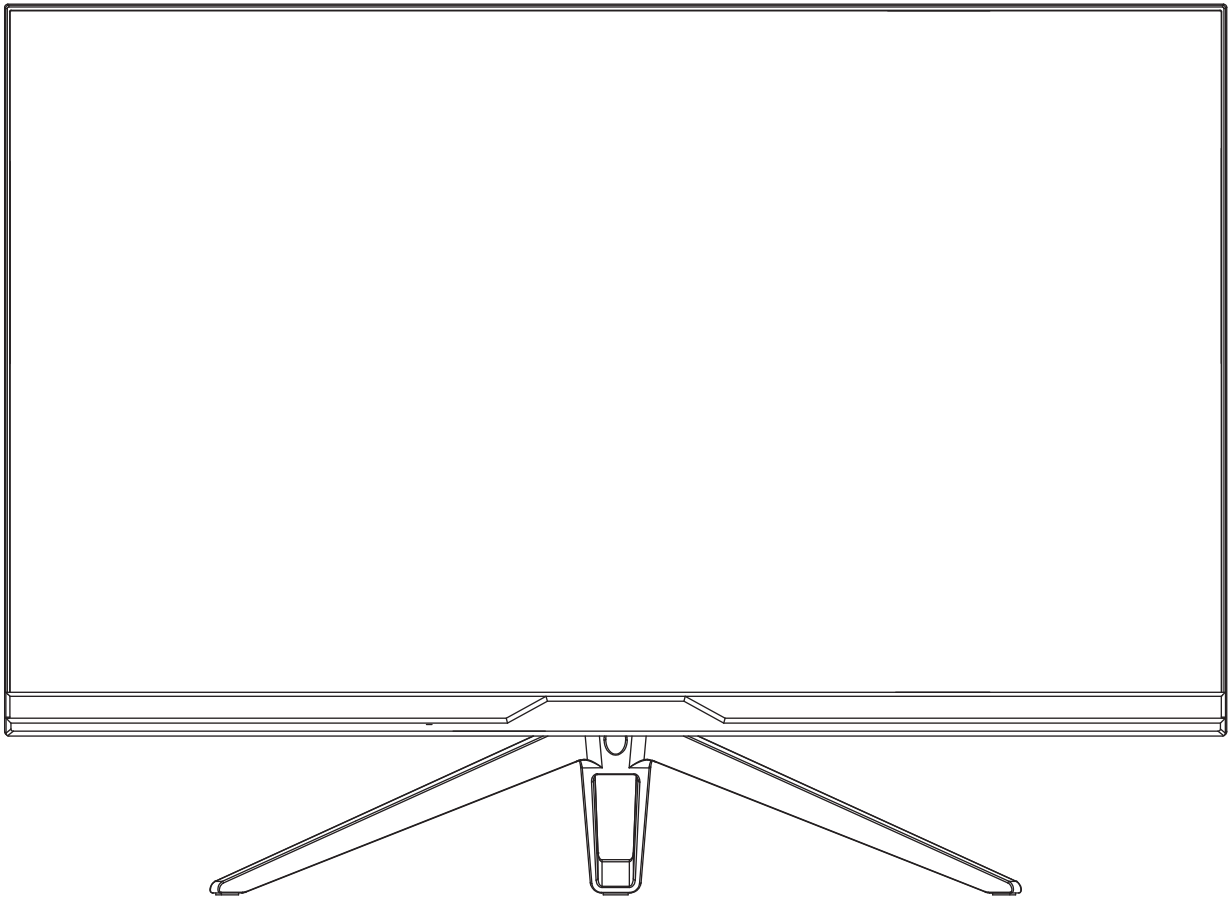

Instruction Manual

Please read this manual thoroughly before use and keep it handy for future reference

GENERAL INFORMATION

Dear Customer,

Thank you for having purchased this product. This document describes how to install and use the LCD color monitor. Read this manual which contains information for correct, safe use carefully. Keep this manual at hand so that you can refer to it when needed.

PRODUCT DESCRIPTION AND TYPE OF USE

The LCD color monitor presents a very rugged structure. It is designed for continuous operation and can be used in closed circuit TV systems without risks of excessive fatigue. The Flat Panel Display has an active matrix, thin-film transistor (TFT), liquid crystal display (LCD).

GENERAL FEATURES

- Display area
- Wallmounting with not included bracket
- Wall mounting VESA standard 100*100mm (Not included bracket)
- One composite, two DP, two HDMI
- Wide inclination to allow viewing either from a seated position or standing up and when moving from one position to the other
- Multilingual OSD menu for easy setting and optimization of the display

OPENING THE BOX

Check that the packing and the contents are not visibly damaged. Contact the retailer immediately if parts are either missing or damaged. Do not attempt to use the device in this case. Send the product back in its original packing if it is damaged.

CONTENTS OF THE BOX

- LCD monitor
- Power Adaptor
- Power cable
- DP cable
- User's manual

Important Note: Accessories may be changed without prior notice.

WARNINGS

POWER

- Only use the power unit provided to power the device. Check mains rating before plugging the power unit in.
- Do not pull the cable to unplug the device.

SAFETY PRECAUTIONS

- Keep the device away from rain and humidity to prevent risk of fire and electrocution. Do not introduce material (solid or liquid) inside. If this should accidentally occur, disconnect the device from the mains and have it inspected by qualified personnel.
- Never open the device. In all cases, contact the qualified personnel or authorized service center for repairs.
- Keep the device away from children, to prevent accidental damage.
- Do not touch the device with wet hands to prevent electrical shock or mechanical damage.
- Do not use the device if it should fall or the external casing is damaged. Risk of electrocution if the device is used in such conditions. Contact the retailer or authorized installer.
- It is advisable to disconnect the power wire if the monitor is not used for a certain time.

INSTALLATION PRECAUTIONS

- To prevent overheating the device, arrange it in a position allowing the flow of air through the slots in the casing. Ensure at least 5 cm of free space when installing inside a rack. For the same reason, do not install near sources of heat, such as radiators or hot air ducts. Keep away from direct sunlight. Do not install in areas subject to excessive dust, mechanical vibrations or shocks.
- Do not arrange this device on an unstable surface, such as a tottering or slanted table. The device could fall causing injury or mechanical failures.
- Do not install the device in a place where it could be exposed to humidity or water. Do not direct a jet of water onto the device: risk of fire, electrocution or mechanical failure.
- Stop using the device if water or other material should penetrate inside: risk of fire and electrocution. Contact the retailer or authorized installer.
- Slots and openings in the cabinet are provided for ventilation. These openings must not be blocked or covered.
- Do not place heavy or heat generating objects on top of the device: this could damage the casing and/or increase internal temperature causing faults.
- Do not cover the device with a cloth while it is running to prevent deforming the external casing and overheating the internal parts: risk of fire, electrocution and mechanical failure.
- Keep magnets and magnetized objects away from the device to prevent faults.
- Do not use the device in presence of smoke, vapor, humidity, dust or intense vibrations.
- Wait for a while before operating a device immediately after transporting it from a cold place to a warm place and vice versa. Wait on average for three hours: this will allow the device to adapt to the new ambient (temperature, humidity, etc.).
- The monitor is provided with a plastic base and rubber feet. It can be positioned on a horizontal surface, such as a desk or a table. Make sure that the device is fastened firmly and that it is not resting on unstable supports or surfaces. Dropping could cause severe injury and damage the device.
- Remember to adjust the brightness and contrast to obtain a perfect image.
- The monitor can also be installed on the wall by means of a bracket (not provided).

CLEANING THE DEVICE

- Rub delicately with a dry cloth to remove dust and dirt.
- Dip the cloth in neutral detergent if dirt cannot be eliminated with a dry cloth alone.
- Do not use volatile liquids (such as petrol, alcohol, solvents, etc.) or chemically treated clothes to clean the device to prevent deformation, deterioration or scratches to the paint finish.

PRIVACY AND COPYRIGHT

- The LED monitor is a device for Gaming. Recording of images is subject to the laws in force in your country. Recording of images protected by copyright is forbidden.

Product users shall be responsible for checking and respecting all local rules and regulations concerning monitoring and recording video signals. The manufacturing SHALL NOT BE LIABLE for use of this product not in compliance with the laws in force.

Monitor Inputs

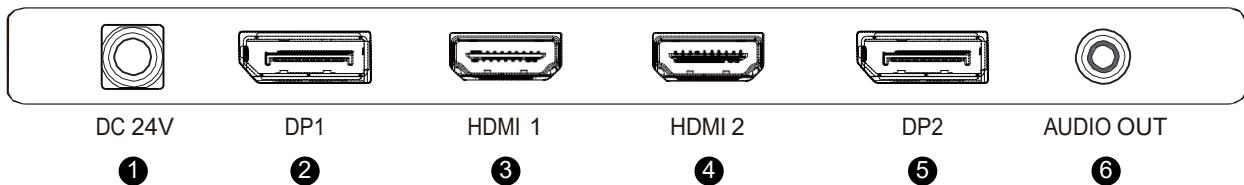

- ① Power
- ② DP1
- ③ HDMI 1
- ④ HDMI 2
- ⑤ DP2
- ⑥ AUDIO OUT

Accessories

PACKAGE INCLUDES



DP

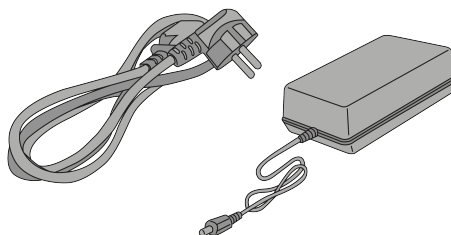

Power Adapter
and Power Cable

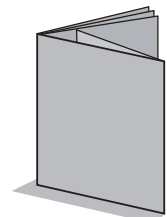

User Manual

GETTING STARTED

MONITOR CONTROLS

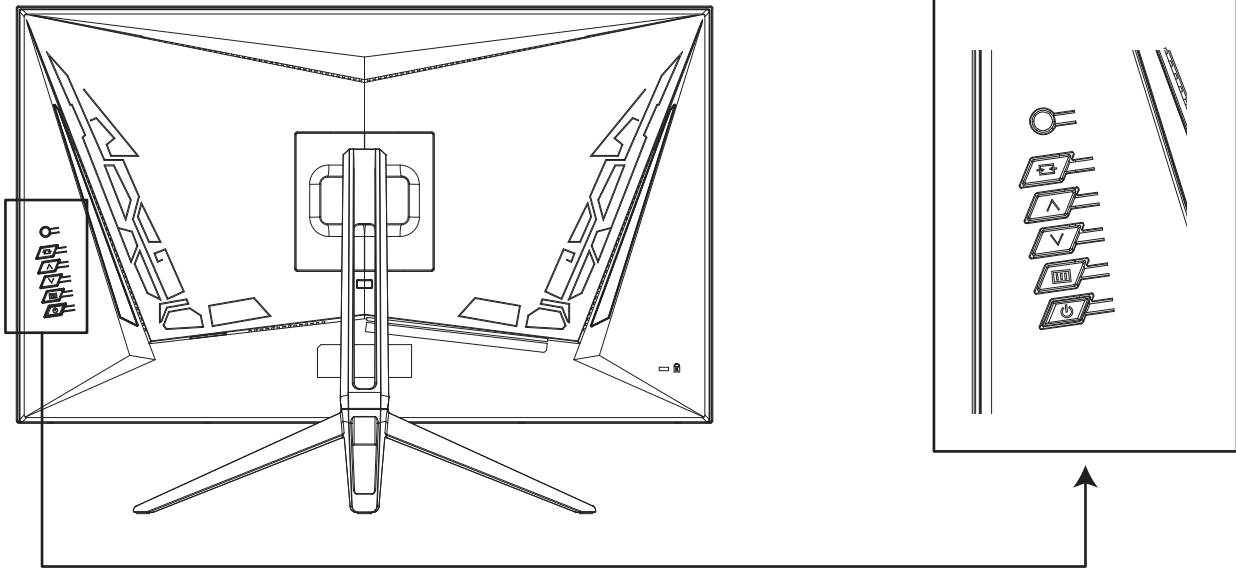

	Select signal source or Exit OSD
	Go Up on the Main OSD Menu increase the value of a selected item
	Go Down on the Main OSD Menu and decrease the value of a selected item
	Open the Main OSD Menu Select submenu
	Turn the monitor on or off

● Video Source Selection Button

To select the desired signal ("Auto Select", "DP1/HDMI1,HDMI2/DP2") press the Monitor Button to select the desired item. Press the "POWER" button to confirm.

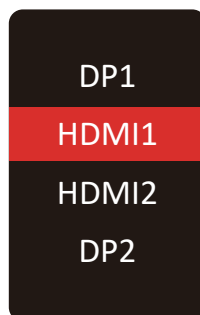

A . View Mode

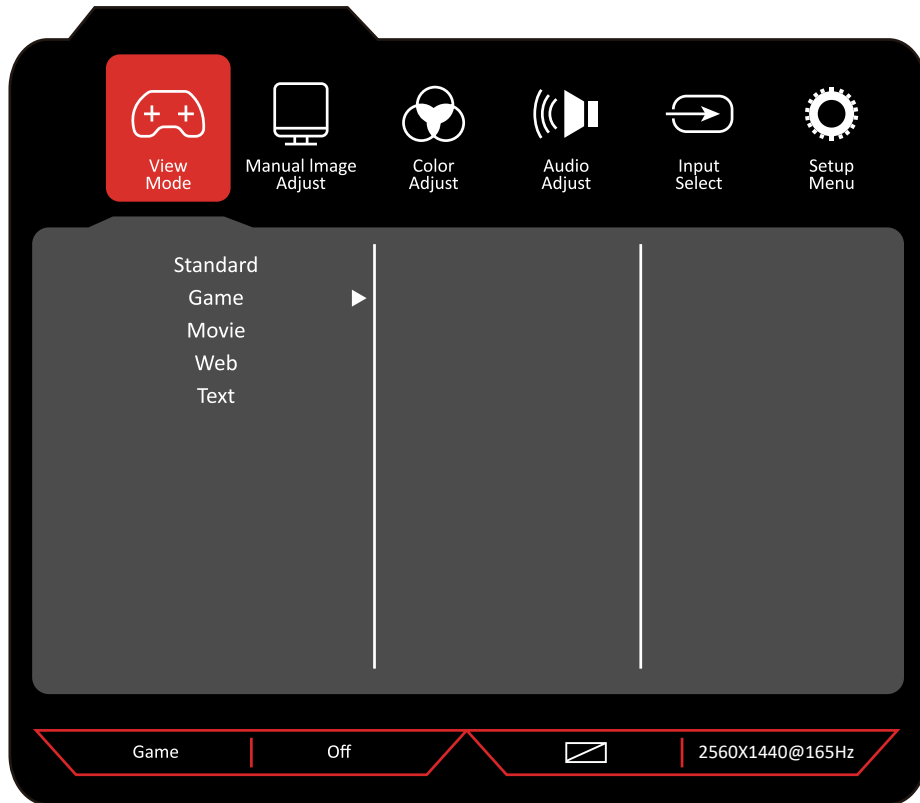

Option	Description
Standard	Enter standard mode
Game	The game mode is divided into FPS1, FPS2, RTS, Night, Vision, Gamer1, Gamer2, Gamer3
Movie	Enter movie mode
Web	Enter web mode
Text	Enter text mode

B . Manual Image Adjust

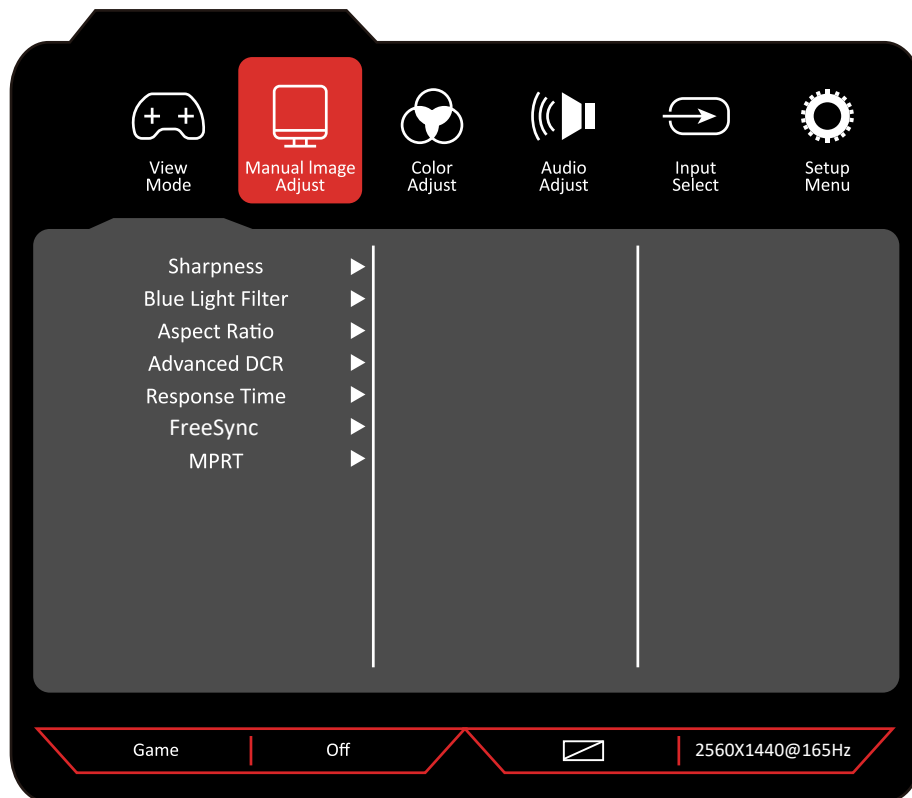

Option	Description	Value
Sharpness	Adjust the clarity	0 ~100
Blue Light Filter	Adjust the display blue light	0 ~100
Aspect Ratio	Adjust the aspect ratio for the screen	4:3/5:4/16:9/16:10/Auto
Advanced DCR	Set the dynamic contrast ratio feature	ON/OFF
Response Time	Set the response time feature	ON/OFF
FreeSync	Set the FreeSync feature	ON/OFF
MPRT	Set the MPRT feature	ON/OFF

C. Color Adjust

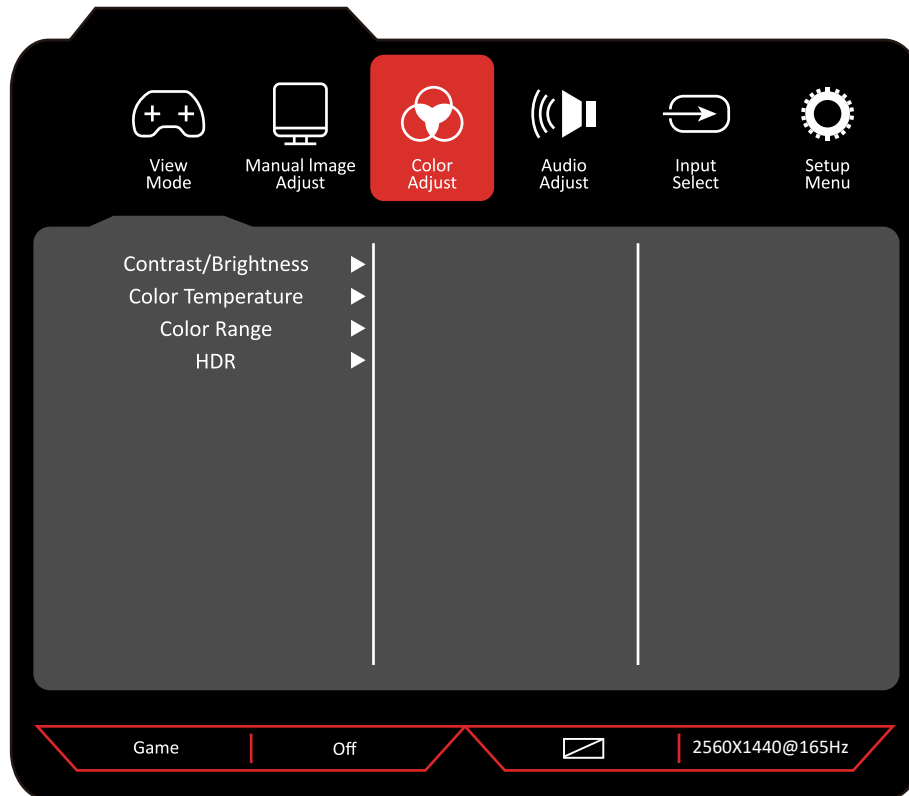

Option	Description	Value
Contrast/ Brightness	Adjust the display brightness value contrast	0 ~100
Color Temperature	Adjust color temperature	User/Cool/Normal/Warm
Color Range	Adjust the color range	0 ~100
HDR	HDR setting	ON/OFF

D . Audio Adjust

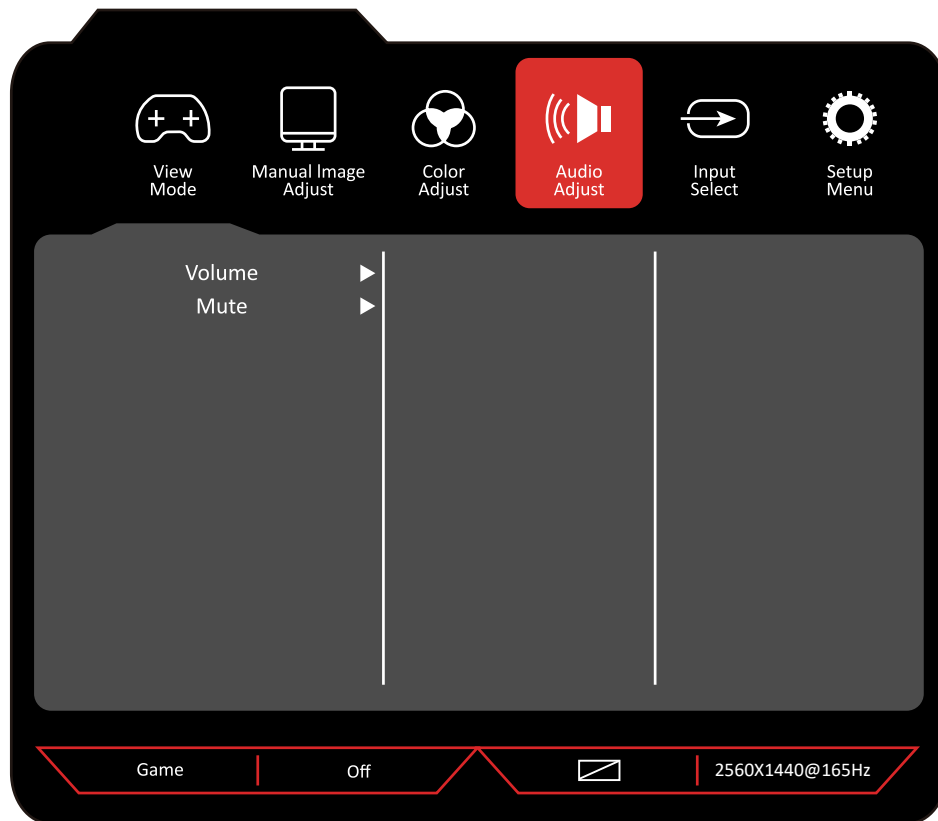

Option	Description	Value
Volume	Adjust the audio source volume	0 ~100
Mute	Set the Mute of the audio source	ON/OFF

E. Input Select

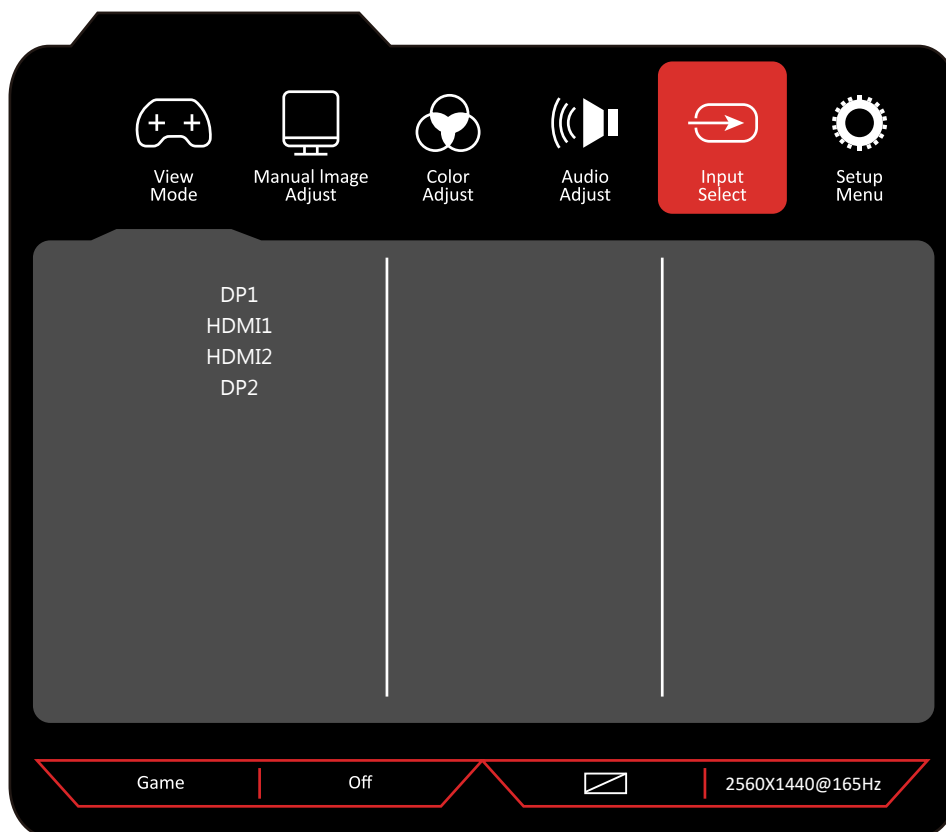

Option	Description
HDMI	Switch the signal input to DP1 / HDMI1 / HDMI2 / DP2
DP	

F. Setup Menu

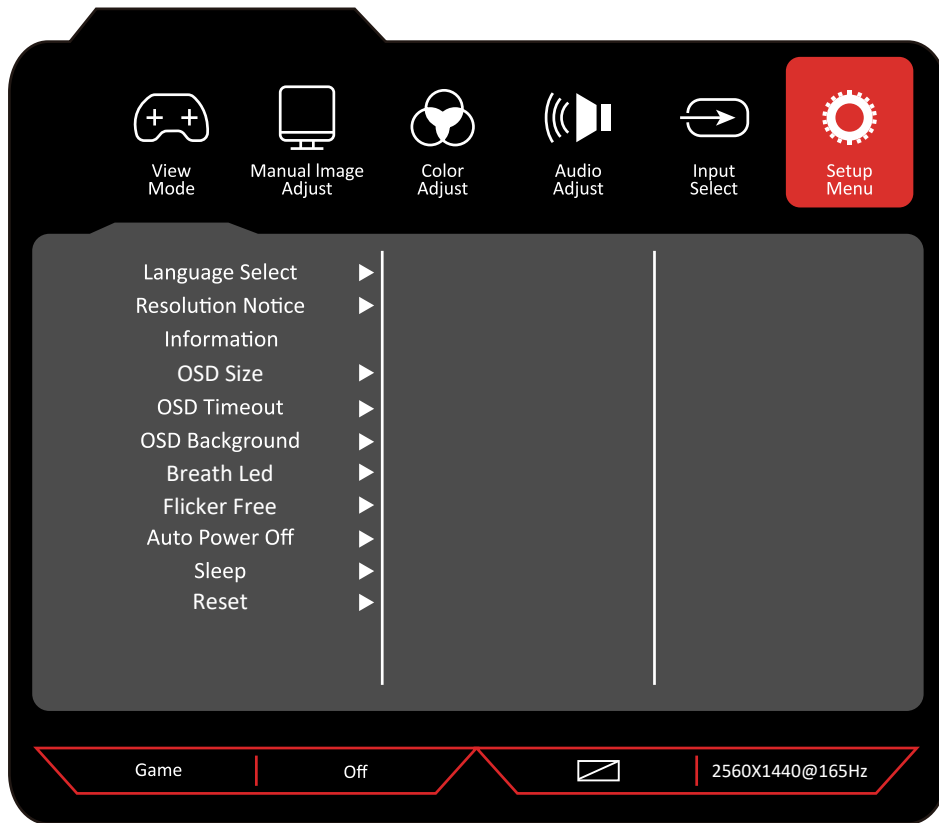

Option	Description	Value
Language Select	Set the OSD Menu display language	English/Chinese/etc.
Resolution Notice	Set resolution Notice feature	ON/OFF
Information	Resolution:2560x1440 / Horizontal frequency: 138.9KHz / Vertical frequency: 95.1Hz / Clock frequency: 377.8MHz	/
OSD Size	Set the OSD Size feature	ON/OFF
OSD Timeout	Set the OSD Timeout	0 ~100
OSD Background	Set the OSD Background feature	ON/OFF
Breath Led	Set the Breath Led feature	ON/OFF
Flicker Free	Set the Flicker Free feature	ON/OFF
Auto Power Off	Set the Auto Power Off feature	ON/OFF
Sleep	Set the screen sleep time	30/45/60/120/OFF
Reset	Restore factory default setting	/

Model	32" RAIDER-165Hz QHD ULTRA GAMING
Size	32"
Panel Type	IPS
Refresh	165Hz
Response Time (Max)	1ms
Resolution	2560x1440
Aspect Ratio	16:9
Pixel Pitch	0.273(H)×0.273(V)
Viewing Angle	178°(H)/178°(V)
Brightness (Max)	400cd/m ²
Display Color	16.7M (8-bit)
Ports	HDMI x 2 / DP x 2
Speaker	Off
Safety & EMC Certification	CE / FCC / RoHS
Power Type	DC 24V / 2.7A
Power Source	100~240V AC
Power Consumption	Typical 32W