









MANUAL

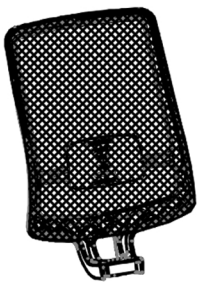

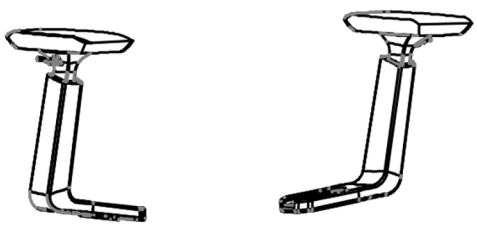
<p>A</p> <p>1pc</p>  <p>Seat</p>	<p>F</p> <p>5pcs</p>  <p>Castors</p>
<p>B</p> <p>1pc</p>  <p>Back</p>	<p>1</p> <p>4pcs</p>  <p>Screw</p> <p>6x35</p>
<p>C</p> <p>1 set</p>  <p>Armrests</p>	<p>2</p> <p>6pcs</p>  <p>Washer</p> <p>6x16</p>
<p>D</p> <p>1pc</p>  <p>Base</p>	<p>3</p> <p>3pcs</p>  <p>Screw</p> <p>8x20</p>
<p>E</p> <p>1pc</p>  <p>Gas lift</p>	<p>4</p> <p>2pcs</p>  <p>Screw</p> <p>6x45</p>

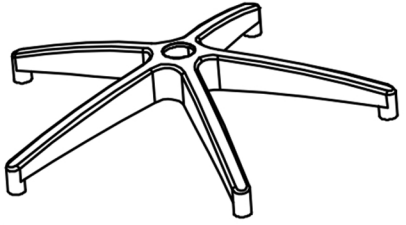
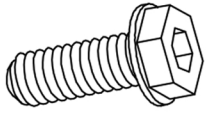
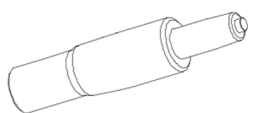
Step 1 /

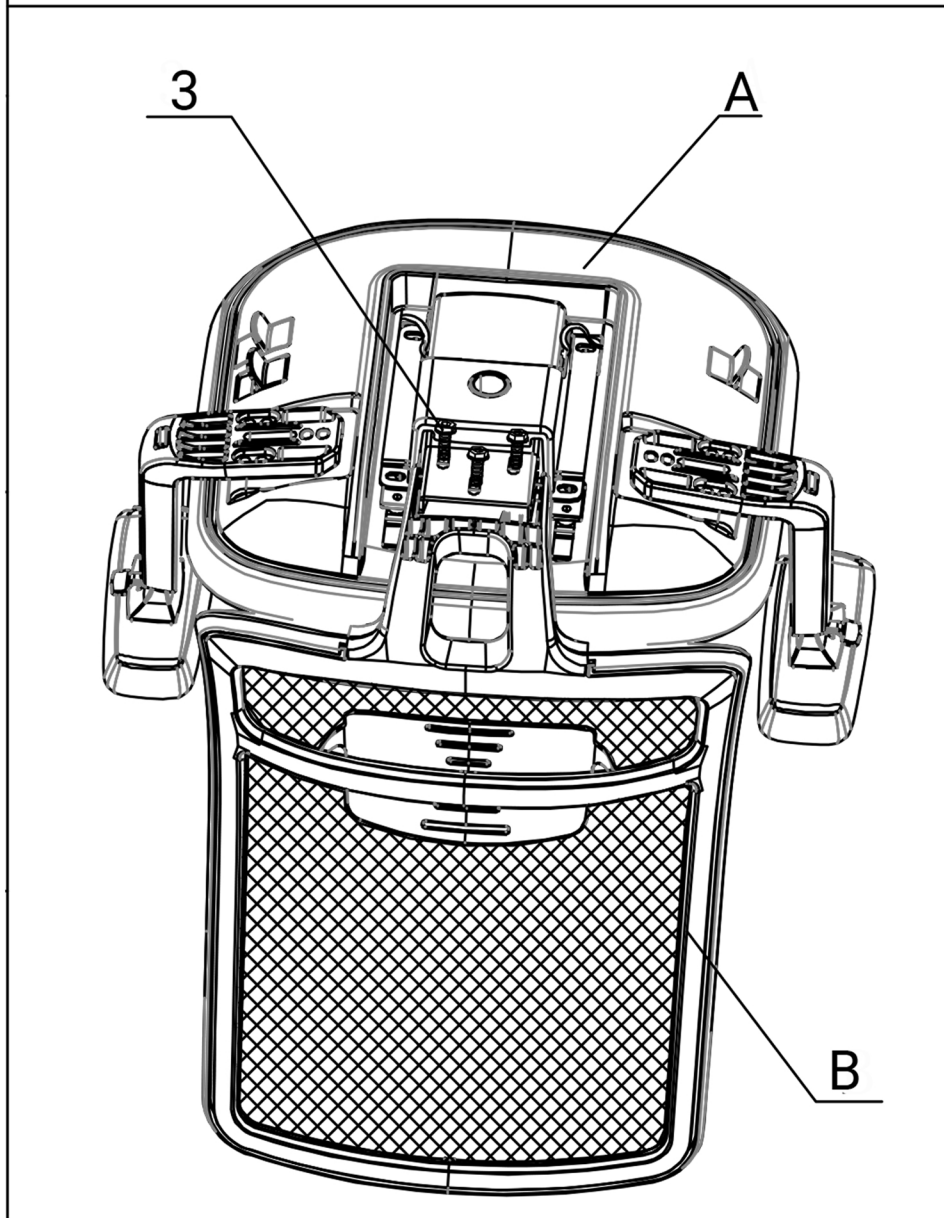
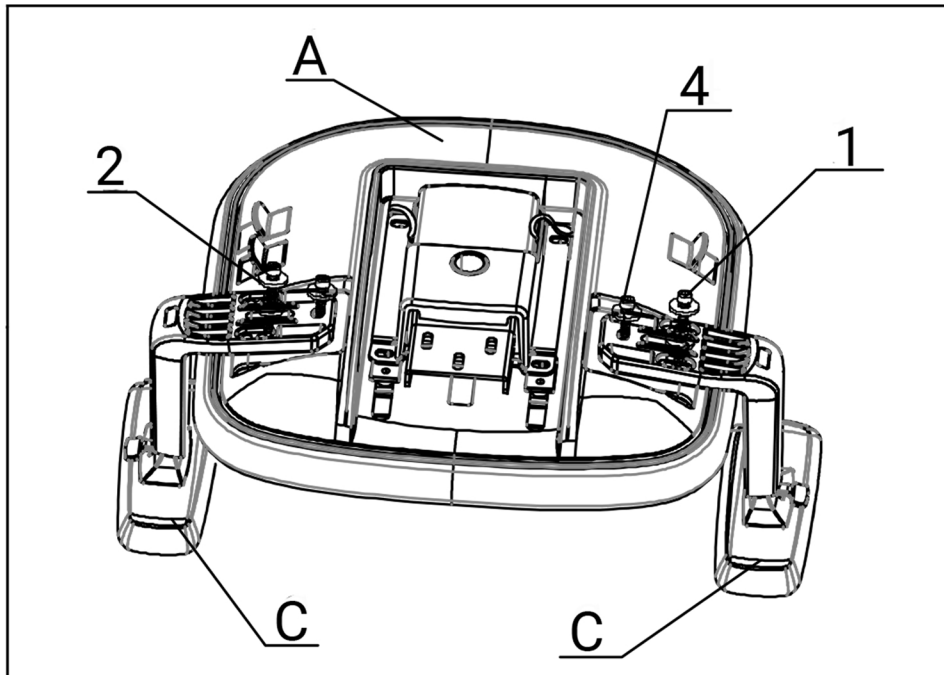

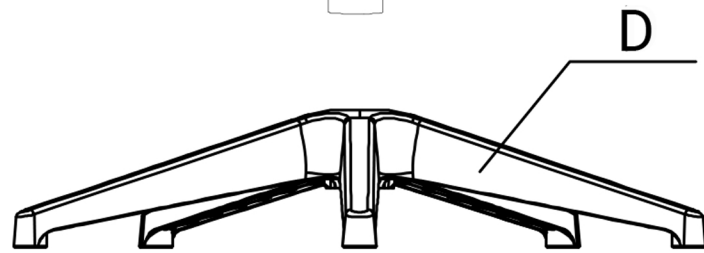
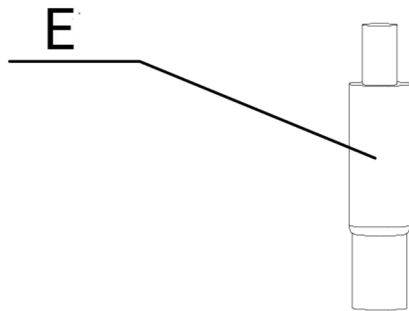
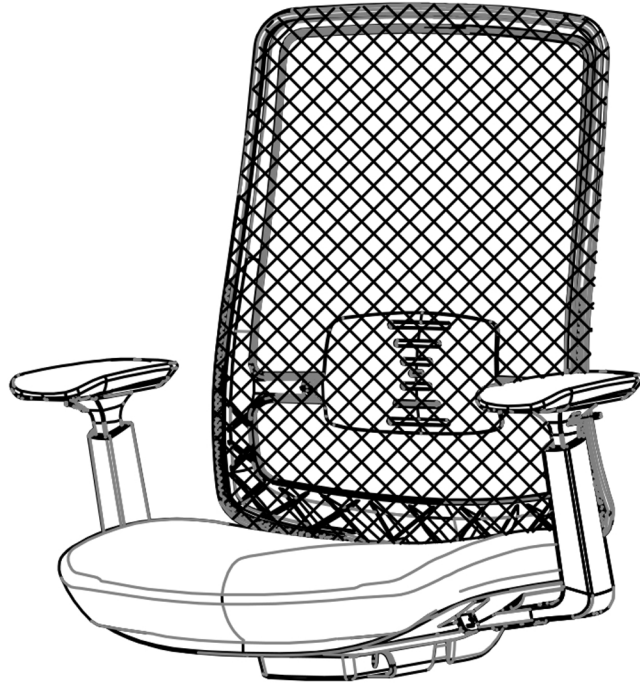

F