

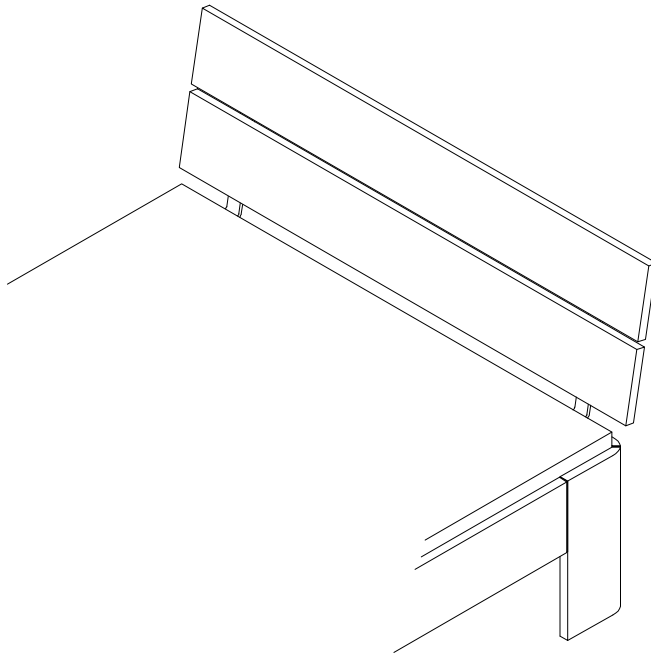

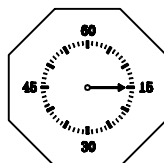

Bed Fresh Montage Handleiding

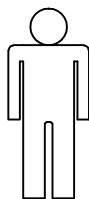
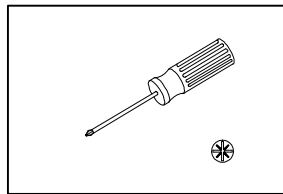
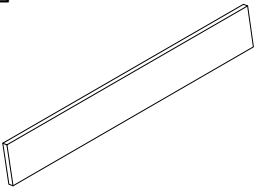
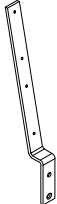

Tools



| | | | | |
|---|---|--|--|---|
| <p>Q x2</p>  | <p>R x2</p>  | <p>F x8</p>  <p>M8x20</p> | <p>H x4</p>  <p>M8x25</p> | <p>P x1</p>  |
|---|---|--|--|---|

Step 1

