

# Lenco

**DVP-735**

**PORTABLE 17,5 CM (7") DVD  
PLAYER WITH USB- & CARDSLOT  
AND HEADPHONE**

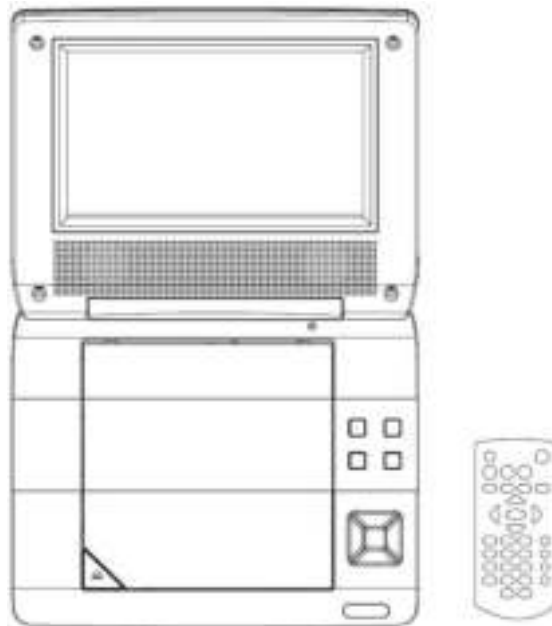

## **User manual English**

Lenco recommends attentive reading of the manual before operating the unit.  
For information and support, [www.lenco.eu](http://www.lenco.eu)

V1.0

## Table of content

Box content .....	2
Important notes .....	3
Maintenance.....	4
1. Exploring the player .....	5
1.1. Main Unit .....	5
1.2. Remote control unit .....	5
2. Basic connections .....	6
2.1. AC/DC Power adaptor.....	6
2.2. Car Adaptor .....	6
2.3. Headphone.....	7
2.4. Connecting to a TV set.....	7
2.5. Mounting the car bag .....	7
3. Basic controls.....	8
4. Basic operations.....	8
4.1. Placing the battery inside the remote control.....	8
4.2. Built-in battery .....	8
4.3. Turning the player on/off .....	9
4.4. Playing a disc .....	9
4.5. USB SD MMC operation .....	11
5. Basic settings of the player (OSD Menu).....	11
6. Troubleshooting .....	12
7. Specifications .....	12
8. Disclaimer .....	13
9. Recycling .....	13

## Dear Customer

Thank you for purchasing this portable 17,5 CM (7") DVD player with USB- & cardslot and headphone. When opening the box for the first time, please check whether all the accessories are present. Before connecting parts and power, please carefully read the user manual and always keep these instructions close by your portable 17,5 CM (7") DVD player with USB- & cardslot and headphone.

## Box content

1x Main unit with build in battery	1x AC/DC adaptor	1x Headphone
1x remote control	1x Car adapter	1x AV cable
	1x Car mounting bag	1x User manual

**Note:** if some parts are missing please contact your dealer as soon as possible.

## Important notes

### Safety

- As the laser beam used in the CD player section may be harmful to the eyes, do not attempt to disassemble the cabinet. Refer servicing to qualified personnel only.
- The apparatus shall not be exposed to dripping or splashing and that no objects filled with liquids, such as vases, shall be placed on apparatus.
- Should any solid object or liquid fall into the player, unplug the player, and have it checked by qualified personnel before operating it further.

### Placement

- Do not leave the player in a location near a heat source, or in a place subject to direct sunlight, excessive dust or mechanical shock.
- Do not place the player on an unstable place.
- Do not place anything within 1 inch of the back of the cabinet. The ventilation holes must not be covered for the player to operate properly and prolong the life of its components.
- If the player is left in a car parked in the sun, be sure to choose a location in the car where the player will not be subjected to the direct rays of the sun.
- Since a strong magnet is used for the speakers, keep personal credit cards using magnetic coding or spring wound watches away from the player to prevent possible damage from the magnets.

### Power Sources

- Lenco recommends using A brand batteries for longer life & results.
- When the batteries will not be used for a few weeks or more, remove them to avoid damage that can be caused by battery leakage or corrosion.
- Battery shall not be exposed to excessive heat such as sunshine, fire or the like.

If at any time in the future you should need to dispose of this product please note that: All batteries and accumulators need to be removed from this product (Removal of Waste Batteries and Accumulators).

### WARNING :

- Do not install this equipment in a confined or building-in space such as a book case or similar unit, and remain a well ventilation conditions at open site. The ventilation should not be impeded by covering the ventilation openings with items such as newspaper, table-cloths, curtains etc.
- WARNING: Only use attachments/accessories specified or provided by the manufacturer (such as the exclusive supply adapter, battery etc).
- WARNING : Please refer the information on exterior bottom enclosure for electrical and safety information before installing or operating the apparatus.
- WARNING : To reduce the risk of fire or electric shock; do not expose this apparatus to rain or moisture. The apparatus shall not be exposed to dripping or splashing and that objects filled with liquids, such as vases, shall not be placed on apparatus.
- WARNING: The battery (battery or batteries or battery pack) shall not be exposed to excessive heat such as sunshine, fire or the like.
- WARNING: The mains plug is used as disconnect device, the disconnect device shall remain readily operable.
- The USB memory stick should be plugged in the unit directly. USB extension cable should not be used to avoid failing of data transferring and interference caused.
- Lenco recommends keeping the packaging to avoid damages during future transportation.

## **CD**

- Before playing, clean the CD with a cleaning cloth. Wipe the CD from the center out.
- Do not expose the CD to direct sunlight or heat sources such as hot air ducts, not leave it in a car parked in direct sunlight as there can be a considerable rise in temperature inside the car.
- Do not stick paper or stickers on the CD, nor scratch the CD.
- After playing, store the CD in its case. If there is a scratch, dirt or fingerprints on the CD, it may cause a tracking error or skipping.
- If the player is brought directly from a cold to a warm location, or is placed in a very damp room, moisture may condense on the lens inside the CD player section. Should this occur the player will not operate properly. In this case, remove the CD and wait about an hour for the moisture to evaporate.
- To be completely disconnect the power input, the mains plug of apparatus shall be disconnected from the mains .As the disconnect devices is the mains plug of apparatus.
- The mains plug of apparatus should not be obstructed OR should be easily accessed during intended use.
- This CD player is designed to be played on a stable no vibration position. If you bump the set during CD play, the music will stop or skip for a few seconds. This is normal for this type of player.

## **Scratched discs**

If your disc is badly scratched, it will not play. You may be able to repair the disc if you buy a disc polisher.

## **Maintenance**

### **Cleaning the Lens**

If the lens becomes dirty, it may cause a skipping of sound during CD operation. Clean with a commercially available lens cleaner and blower or carefully wipe it with a soft dry cloth.

### **Cleaning the Cabinet**

Clean the cabinet, panel and controls with a soft cloth slightly moistened with a mild detergent solution. Do not use any type of abrasive pad, scouring powder, or solvent, such as alcohol or benzene.

# 1. Exploring the player

## 1.1. Main Unit

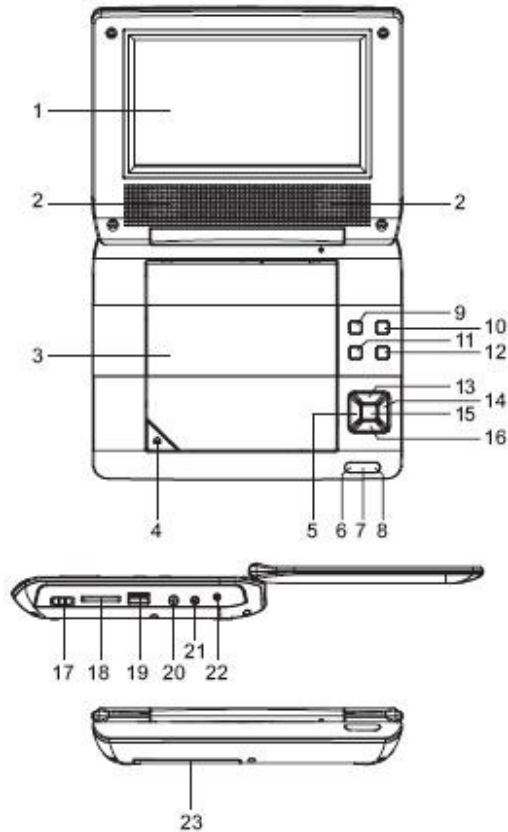

1. TFT Screen
2. Speakers
3. Disc cover
4. Disc cover open button
5. Volume- & Navigation left button
6. Charge indicator
7. Remote sensor
8. Power indicator
9. Play/Pause button
10. Stop & USB/SD/MMC card button
11. Previous & Fast back button
12. Next & Fast forward button
13. Navigation up button
14. Volume+ & Navigation right button
15. OK button
16. Navigation down button
17. Power ON/OFF switch
18. SD/MMC card slot
19. USB port
20. Headphone jack
21. Audio/Video out jack
22. DC in jack
23. Battery compartment

## 1.2. Remote control unit

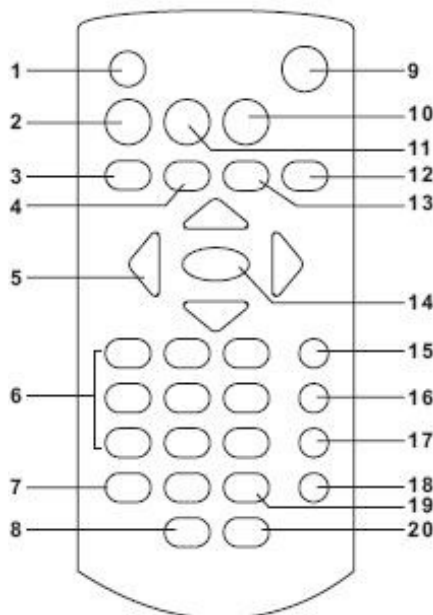

1. Screen on/off & Brightness / Colour adjust button
2. Title button
3. PREV & FAST Backward button
4. NEXT & FAST Forward button
5. Navigation buttons
6. Numeric buttons
7. Program/angle button
8. Volume - button
9. Mute button
10. Setup button
11. Menu button
12. Display button
13. Stop & USB/SD/MMC card button
14. OK (Play/pause) button
15. Subtitle button
16. Audio button
17. Search button
18. Repeat button
19. Zoom/slow button
20. VOLUME + BUTTON

## 2. Basic connections

### 2.1. AC/DC Power adaptor

Connect the player to the 230V wall outlet by using the AC/DC power adaptor (See below instructions). Plug the small round side of the AC/DC adaptor into the dc in jack (22) on the player. The other side of the AC/DC adaptor needs to be plugged into the wall outlet.

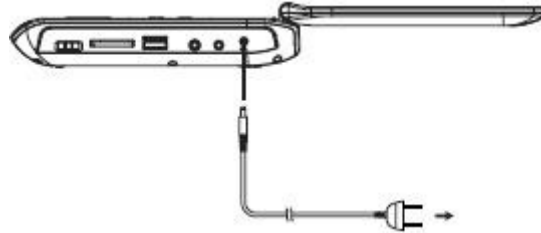

#### CAUTIONS:

- Use the player only with the recommended power adaptor; use with other power adaptor might damage the player.
- The recommended power adaptor is for use with this player only. Do not use it with other equipment.
- After use, disconnect the power adaptor from both the player and wall outlet.

### 2.2. Car Adaptor

The car power adaptor is designed for use with vehicles that have a 12V, negative ground electrical system. Connect the player to the cigarette lighter socket by using the car adaptor (See below instructions). Plug the small round side of the car adaptor into the dc in jack (22) on the player. The other side of the car adaptor needs to be plugged into the cigarette lighter socket.

**WARNING:** Disconnect the car power adaptor when not in use. Not in use in 24V vehicles.

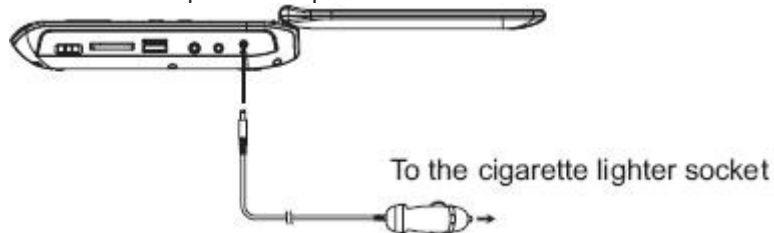

#### CAUTIONS:

- Use the player only with the recommended car power adaptor; use with other car power adaptor might damage the player.
- The recommended car power adaptor is for use with this player only. Do not use it with other equipment.
- In the interests of road traffic safety, do not operate the player or view video software while driving a vehicle.
- Make sure the player is fastened securely to prevent from moving outside of the vehicle in an accident.
- When the inside of the cigarette lighter socket is dirty with ashes or dust, the plug section may become hot due to poor contact. Be sure to clean the cigarette lighter socket before use.
- After use, disconnect the car power adaptor from both the player and cigarette lighter socket.

### Replacing the car adaptor fuse

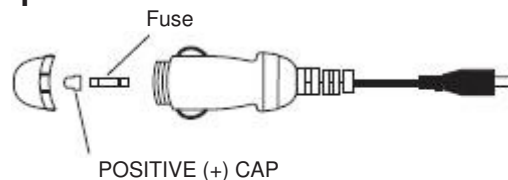

**NOTE:** Don't throw out the positive (+) cap when replace the fuse.

### 2.3. Headphone

It is possible to connect a headphone to the player via the headphone jack (20).

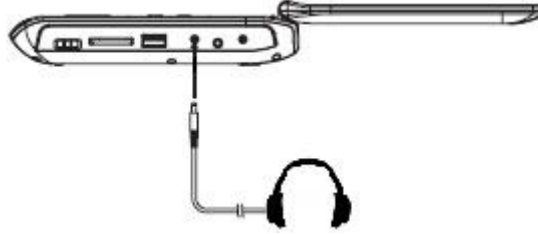

**WARNING:** Prolonged exposure to loud sounds from personal music players may lead to temporary or permanent hearing loss. When participating in the traffic listening to a personal music player can make the listener less aware of potential dangers such as approaching cars.

### 2.4. Connecting to a TV set

Ensure that this player and other equipment are off before you connect them with each other. Connect the payer to a TV by using the AV cable (See below instructions). Plug the small round side of the AV cable into the audio/video jack (21) on the player. The other side of the AV cable needs to be plugged into the TV correctly.

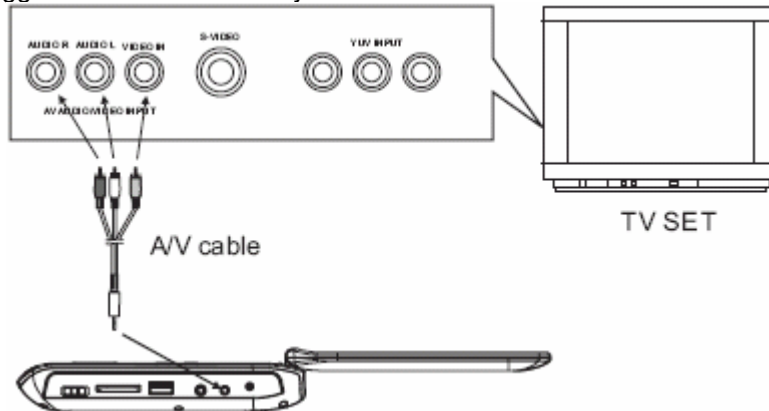

After connection is firm and securely done, plug AC ADAPTER to an applicable wall outlet and turn on the player.

### 2.5. Mounting the car bag

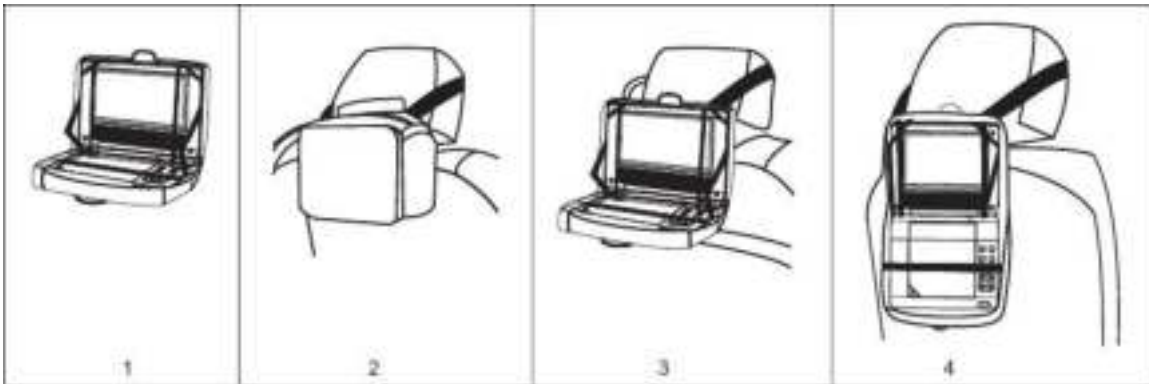

### 3. Basic controls

The following controls are in all different modes the same, so they will not be explained any further in this instruction manual.

On the main unit:

- |            |                        |                                                  |
|------------|------------------------|--------------------------------------------------|
| 4.         | Disc cover open button | press this button to open the DVD door           |
| 5.         | Volume- button         | press this button to decrease the volume         |
| 14.        | Volume+ button         | press this button to increase the volume         |
| 5,13,14,16 | navigation buttons     | press these buttons to navigate trough the menus |
| 15         | OK button              | press this button to confirm                     |

On the remote control:

- |     |                                                 |                                                                                                                                                                                                                                                                                                                       |
|-----|-------------------------------------------------|-----------------------------------------------------------------------------------------------------------------------------------------------------------------------------------------------------------------------------------------------------------------------------------------------------------------------|
| 1.  | Screen on/off & Brightness/Colour adjust button | Press this button to adjust the brightness; "BRI" will appear on the display. Press it again to adjust the colour; "COL" will appear on the display. Adjust the levels by pressing left/right navigation buttons (5). Press and hold button 1 to turn off the LCD screen. Press and hold again to turn the screen on. |
| 5.  | Navigation buttons                              | Use these buttons to navigate trough the menus                                                                                                                                                                                                                                                                        |
| 6.  | Numeric buttons                                 | Use these buttons to input digits                                                                                                                                                                                                                                                                                     |
| 8.  | Volume- button                                  | Press this button to decrease the volume                                                                                                                                                                                                                                                                              |
| 9.  | Mute button                                     | Press this button to turn off/on the sound                                                                                                                                                                                                                                                                            |
| 10. | Setup button                                    | Press this button to enter the setup menu                                                                                                                                                                                                                                                                             |
| 14. | OK button                                       | Press this button to confirm while navigating trough the menu's                                                                                                                                                                                                                                                       |
| 20. | volume+ button                                  | Press this button to increase the volume                                                                                                                                                                                                                                                                              |

### 4. Basic operations

#### 4.1. Placing the battery inside the remote control

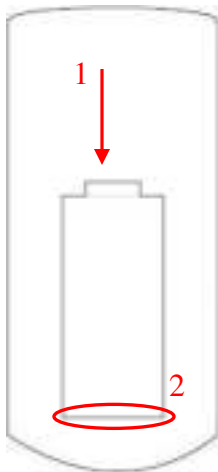

To open the battery cover of the remote control press the locker into direction 1 and than lift it. Now you can insert the batteries into the compartment. Do not forget to check the polarisation.

To close the battery door hook in the cover at point 2 and push it back into original position.

#### 4.2. Built-in battery

The player is equipped with a built-in rechargeable lithium battery. Before using the player for the first time the battery needs to be charged for at least 8 hours. When the battery is fully charged it will last for at least 1.5 hours. To charge the battery make sure the power switch is in of mode and connect the player to a power source.

Note: The battery can only be charged in power off mode.

If the player will not be used for a long period it is recommend to charge the battery each three months

Fully charging the battery takes 3 hours. If the battery is charged the red light will turn off



### **Replacing the battery**

Remove screw 1 on the back side of the player. Now the battery cover can be removed. Remove the battery from the player by pulling the cable and plug into direction 2. Connect the new battery to the main unit repeat these steps in opposite direction.



### **4.3. Turning the player on/off**

Make sure that the battery is charged or that the player is connected to a power source. To turn on the player slide the ON/OFF switch (17) into on position. To turn off the player side the ON / OFF switch into off position.

### **4.4. Playing a disc**

#### **Inserting a disc**

Before you insert a disc make sure that the player is in off mode. Press the disc cover open button to open the disc cover. Insert a disc with the label side up and press on the disc cover to close the disc door. Now the player will start to read & play the disc automatically. The player will automatically navigate to the disc menu.

#### **IMPORTANT NOTES:**

All the functions described below are defined from out playback mode. Some of the functions described below may function different because they depend on disc specification.

#### **RETURN TO DISC MENU**

Press MENU button to return to the disc menu.

#### **Skip ahead or back**

Press PREVIOUS or NEXT button once to skip a chapter (DVD) or a track (CD) ahead or backwards.

#### **RAPID ADVANCE/REVERSE**

Press and hold FAST BACKWARD or FAST FORWARD button several times to scan the disc forward or backward at X2, X4, X8, X16, X32 normal speed. Press PLAY/PAUSE button to resume normal play.

#### **STOP PLAYBACK**

Press STOP button to stop playback; press PLAY button to resume playback at the point it stopped previously; press the STOP button twice to clear the resume function. Press and hold the STOP button to switch between DVD, MCR (Media Card Reader) and USB mode.

#### **SLOW-MOTION PLAY**

Press and hold ZOOM/SLOW button on the remote control, the Disc will be played at 1/2 normal speed at first, each time this button is pressed, the play speed becomes slower at 1/4, 1/8 and 1/16 speed.

## **REPEAT**

Press REPEAT button, the player will repeat play one chapter/title or repeat all (for DVD disc), or repeat play a track or all tracks (CD), or repeat the sections between two specific points (A-B).

## **SEARCH FOR PREFERRED SCENE**

1. Press SEARCH button several times to show different Search mode.
2. Input the desired number or time via the numeric buttons.
3. Press OK (PLAY/PAUSE) button to confirm and start the playback from the selected scene.

*Note: If nothing has been entered, the search menu will disappear automatically.*

## **ON SCREEN DISPLAY INFORMATION**

Press DISPLAY button continuously on the remote control, the screen will display parts of information in a sequence.

## **CHANGING AUDIO SOUNDTRACK LANGUAGE**

It is possible to change the audio language in both the setup menu as during playback. Press the AUDIO button to change the sound track language during DVD disc play. When the desired language appears, do not press any button and wait for a few seconds to activate the language.

## **CHANGING SUBTITLE LANGUAGE**

To change the subtitle language; Press SUBTITLE button, the subtitle language will change on the screen as a response to each press; when the desired language appears, do not press any button and wait for a few seconds to activate the subtitle language.

## **PROGRAM PLAY (UP TO 20 MEMORIES)**

1. Press PROGRAM to display the program menu.
2. Select the desired MEM location via the navigation buttons and then enter the desired Titles/Chapters/tracks number via the numeric buttons.

Note: It is unnecessary to input the leading figure zero.

Example: Track 3, press "3"

Track 12, press "1" and then "2"

Track 21, press "2" and then "1"

3. To start programmed playback, scroll to START and then press OK (PLAY/PAUSE) button.
4. To clear all programmed items, press the PROGRAM button to enter the program menu, now STOP will be highlighted on the menu, press OK button once to confirm, then EXIT will be highlighted, press OK to clear all the programmed item.

## **ZOOMPLAY**

Press the ZOOM key continuously to zoom in the picture by 2, 3, and 4 times. Scroll to the different sides of the enlarged picture using the navigation buttons.

## **MULTI-ANGLE VIEWING**

Press and hold ANGLE button to select the desired angle to view the scene.

Note: not every disc supports this function.

## **KODAK PICTURE CD / JPEG CD PLAYBACK**

Slide show of Kodak Picture CD begins automatically. The folders of the JPEG picture CD will be displayed on the screen.

## **KODAK PICTURE CD/JPEG CD OPERATION**

### **PLAY MODE**

Press REPEAT button to change play mode. Press STOP button to show folders / files on the disc.

## **SKIP TO NEXT/PREVIOUS PICTURE**

Press NEXT button to skip to the next picture or PREV button to the previous picture.

## **PICTURE ROTATIONS**

Press RIGHT and LEFT navigation buttons to rotate the picture Clockwise and anti-clockwise respectively.

## **PICTURE FLIPS**

Press UP NAVIGATION button to flip the picture vertically. Press DOWN NAVIGATION button to flip the picture horizontally.

## **PICTURE ZOOM IN/OUT**

Press ZOOM button continuously, the picture zooms in and out. If the picture is enlarged, you may use the navigation buttons to view the other parts of the picture.

## **4.5. USB SD MMC operation**

Make sure that the unit is turned on. Now insert a USB device or insert a SD/MMC card with the label side up. Wait a few seconds so that the player can recognize the device. The player will now display the root menu of the device. If you are playing a disc; press and hold the STOP button for several seconds until the media selection menu appears. Here you can select the desired mode.

## **5. Basic settings of the player (OSD Menu)**

In this menu the preferred (default) settings can be set. To open / close the settings menu press the SETUP button.

### **General setup**

TV Display This function must match with your TV set.  
LCD Mode Select aspect ratio 4:3 or 16:9.  
OSD Language Select the language of the OSD menu.  
Screen saver Set the screen saver function ON or OFF  
Exit setup Select this to exit the setup menu

### **Video setup**

Brightness set the brightness of the display.  
Contrast set the contrast effect of the display.  
Hue set the hue of the display.  
Saturation set the saturation of the display.  
Exit setup select this to exit the setup menu

### **System setup**

TV type This function must match with your TV set.  
Audio Select the default audio language when playing a DVD  
Note: not every disc supports this function  
Subtitle Select the default subtitle language when playing a DVD  
Note: not every disc supports this function  
Disc menu Select the default disc menu language when playing a DVD  
Note: not every disc supports this function  
Parental Set the parental lock level  
Note: not every disc supports this function  
Password Select this option to change the password.  
The supervisor password is 1389  
Default Reset all settings back to factory settings  
Exit setup select this to exit the setup menu

## 6. Troubleshooting

If your DVD player does not seem to function properly, check the below items before you contact your dealer.

Symptom	Check
Power does not turn on or suddenly turns off.	Make sure the AC adaptor is securely plugged into an AC outlet
	Make sure the battery is charged
	Turn the power off and then back on
No picture or sound	Check if the disc format is supported
	Check if the disc is not damaged
	Check that the disc is inserted with the label-side up
	Check if the lens is clean
No picture	Check if the LCD is turned on
No sound	Check that the display is opened. if it is closed the speakers will be disabled
	Check the volume level

## 7. Specifications

Power source: AC 100-240V 50/60Hz

Power consumption: 8.5W

TV systems supported: PAL/NTSC/AUTO

Operating Temp. Range: +5 C to +35C

Continuous playing time: 120 minutes

Dimensions: 210(L) x 171(W) x 39.8(H) mm

Operating Humidity Range: 10 % to 75 %

Battery of Remote Control: AAA1.5V x 2

Discs supported:

1. DVD-VIDEO disc

12 cm single-sided, single-layer

12 cm single-sided, dual-layer

12 cm double-sided, single-layer

8 cm single-sided, single-layer

8 cm single-sided, dual-layer

8 cm double-sided, single-layer

2. CD-DA/CD-R/CD-RW/MP3 -CD

12cm disc, 8cm disc

Audio signal output:

1. DVD (linear audio)

(1) Frequency response: 20Hz-20KHz (48KHz sampling)&20Hz-20KHz (96KHz sampling)

(2) S/N ratio: >45dB

(3) Dynamic range: 90dB

2. CD audio:

(1) Frequency response: 20Hz-20KHz

(2) S/N ratio: >45dB

(3) Dynamic range: 90dB

Specifications are subject to change without notice

## 8. Disclaimer

Updates to Firmware and/or hardware components are made regularly. Therefore some of the instruction, specifications and pictures in this documentation may differ slightly from your particular situation. All items described in this guide for illustration purposes only and may not apply to particular situation. No legal right or entitlements may be obtained from the description made in this manual.

## 9. Recycling



If at any time in the future you should need to dispose of this product, please note that: Waste electrical products should not be disposed of with household waste. Please recycle where facilities exist. Check with your Local Authority or Retailer for recycling advice. (Waste Electrical and Electronic Equipment Directive)

If at any time in the future you should need to dispose of this product please note that: All batteries and accumulators need to be removed from this product (Removal of Waste Batteries and Accumulators).

Use the following instructions to readily remove the batteries and/or accumulators:

Remove screw 1 on the back side of the player. Now the battery cover can be removed. Remove the battery from the player by pulling the cable and plug into direction 2.

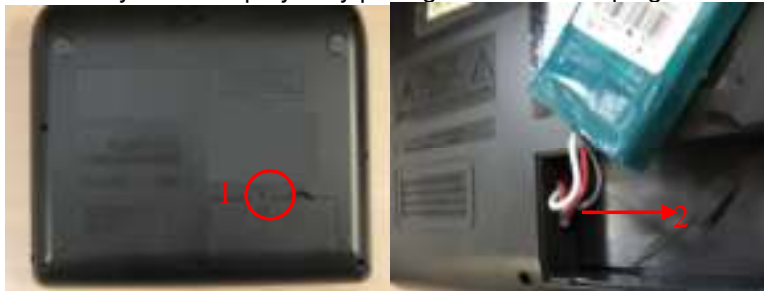

Batteries and accumulators need to be disposed according to the Waste Electrical and Electronic Equipment Directive.