

BOSE

3•2•1[®] GS SERIES III

3•2•1 SERIES III

DVD HOME ENTERTAINMENT SYSTEM

Owner's Guide

Guía de usuario



Notice d'utilisation



SAFETY INFORMATION



Please read this owner's guide

Please take the time to follow this owner's guide carefully. It will help you set up and operate your system properly and enjoy all of its advanced features. Save this owner's guide for future reference.

-  **WARNING:** To reduce the risk of fire or electric shock, do not expose the system to rain or moisture.
-  **WARNING:** Do not expose this apparatus to dripping or splashing, and do not place objects filled with liquids, such as vases, on or near the apparatus. As with any electronic product, use care not to spill liquids in any part of the system. Liquids can cause a failure and/or a fire hazard.



The CAUTION marks shown here are located on the bottom of your 3•2•1® home entertainment system media center and the rear panel of the Acoustimass® module:

-  The lightning flash with arrowhead symbol within an equilateral triangle alerts the user to the presence of uninsulated, dangerous voltage within the system enclosure that may be of sufficient magnitude to constitute a risk of electric shock.
-  The exclamation point within an equilateral triangle alerts the user to the presence of important operating and maintenance instructions in this owner's guide.

 **CAUTION:** To prevent electric shock, match wide blade of plug to wide slot, insert fully.

 **CAUTION:** Do not place any naked flame sources, such as lighted candles, on or near the apparatus.

Class 1 laser product



This CD player is classified as a CLASS 1 LASER PRODUCT according to EN 60825-1:1994+A1+A2, IEC60825-1:1993+A1+A2.

-  **CAUTION:** Use of controls or adjustments or performance of procedures other than those specified herein may result in hazardous radiation exposure. The DVD player should not be adjusted or repaired by anyone except properly qualified service personnel.

Class B emissions limits

This Class B digital apparatus meets all requirements of the Canadian Interference-Causing Equipment Regulations.



Batteries

Please dispose of used batteries properly, following any local regulations. Do not incinerate.

-  This product conforms to the EMC Directive 2004/108/EC and to the Low Voltage Directive 2006/95/EC. The complete Declaration of Conformity can be found at: www.Bose.com/static/compliance/index.html.

Additional safety information

See the additional instructions on the *Important Safety Information* sheet enclosed in the shipping carton.

INTRODUCTION 2

Before you begin	2
For your records	3
Unpacking	4

SETUP 6

1 Placing the system components 6	
2 Connecting the speakers to the module	8
3 Connecting the module to the media center	10
4 Connecting the system video to your TV	12
5 Connecting a cable box or other component ...	17
To connect another component	19
To get digital audio from the component	20
To use video pass through	21
6 Connecting audio from your TV as an option 22	
7 Installing the FM and AM radio antennas	25
8 Connecting the module to a power outlet	28
9 Setting the remote to control your TV and components	30
Inserting the remote batteries	30
Setting the remote for your TV	31
Controlling another component	32

FIRST-TIME USE 33

Trying out the DVD	33
--------------------------	----

CONTROLS AND INDICATORS 34

The remote control	34
Power and source buttons	35
Menu and movement buttons	36
Play and numeric buttons	37
Record and A, B, C buttons (not in Europe)	38
Colored buttons (in Europe only)	38
The media center	39
Display	39
Disc tray	39

OPERATION 40

Playing a video disc or CD	40
Selecting a play option	40
Keeping your discs clean	41
Checking for disc compatibility	42
For DVDs: Setting Parental Control	42
Choosing a password	42
Setting a restriction level	43
Ratings supplied by the MPAA	43

Playing a cable box or other component	44
Adjusting for audio delay	44
Getting digital audio from a source	45
Choosing other options	45
Listening to the radio	46
Creating a preset	46
Removing a station from a preset	46
ADJUSTMENTS TO THE PERFORMANCE	47
<hr/>	
Changing system features	47
To get to the System menu	47
Selecting a new option	48
Language choices	48
Audio options	49
Video options	50
Media center options	52
Choosing new settings	53
To get to the Settings menu	53
Settings options	54

REFERENCE	59
<hr/>	
Replacing remote batteries	59
Protecting the system	59
Cleaning the media center	59
Cleaning the speakers	59
Troubleshooting	60
For customer service	63
Limited warranty	63
Technical information	64

COPYRIGHT AND LICENSE PROTECTIONS 69

DEVICE CODES A-1

INTRODUCTION

Before you begin

Thank you for purchasing the 3•2•1® DVD home entertainment system. Using Bose® proprietary signal processing technology, the 3•2•1 system provides improved spaciousness from stereo recordings and bold movie effects for surround-sound sources.

System features include:

- Small, easy-to-place shelf speakers
- Easy-to-hide Acoustimass® module
- Integrated DVD/CD player and AM/FM tuner
- Remote and media center controls
- HDMI video connection to your TV
- Audio In connectors for three components
- Your choice of language for text displays

For your records

As you unpack the system, look for the serial numbers on the rear of the Acoustimass® module and the bottom of the media center.

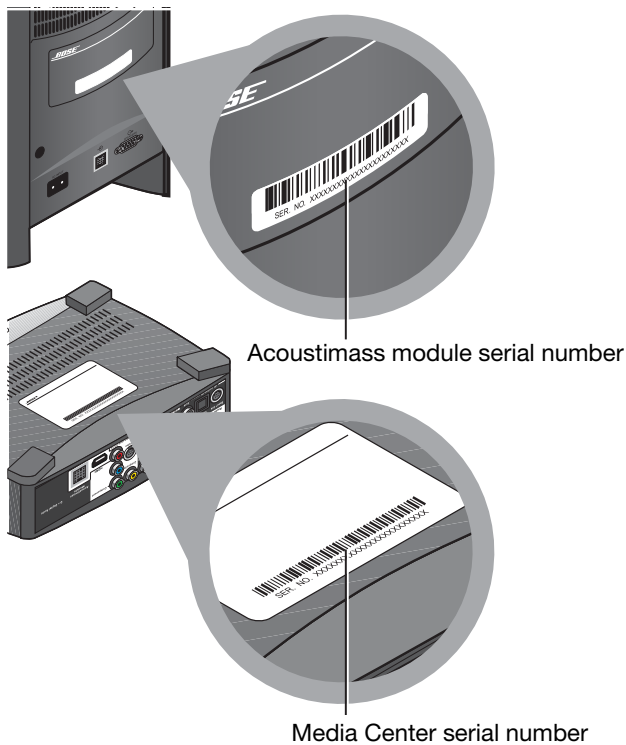

This is a good time to record the serial numbers on the lines below and on your product registration card. You may need them if you ever contact Bose® Customer Service.

Acoustimass module serial number:

Media center serial number:

Dealer name:

Dealer phone:

Purchase date:

We suggest you keep your sales receipt and the warranty information (on the product registration card) together with this owner's guide.

INTRODUCTION

Unpacking

Carefully unpack your system. Save all packing materials, which provide the safest way to transport your system. Make sure your system includes the parts shown.

WARNING: To avoid danger of suffocation, keep the plastic bags out of the reach of children.

As you identify them, you may want to place a check mark in the box next to the name of each part.

If any part of the system appears damaged, do not try to use it. Notify Bose or your authorized Bose® dealer right away. For contact information, refer to the address sheet included in the carton.

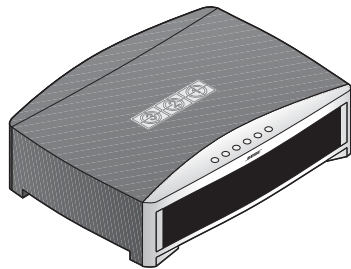

Media center

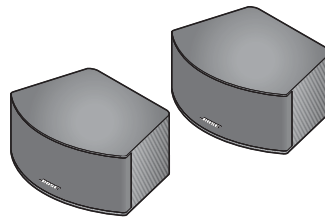

3•2•1® GS speakers

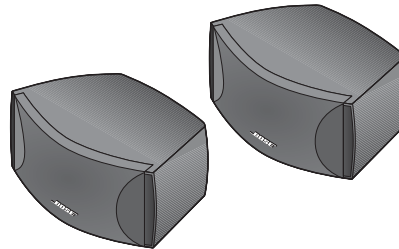

3•2•1 speakers



Acoustimass® module



Remote control and batteries



Rubber feet for Acoustimass® module



Rubber feet for speakers

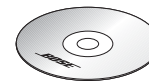

Setup disc

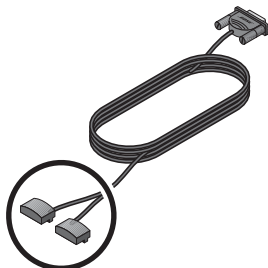

Speaker cable

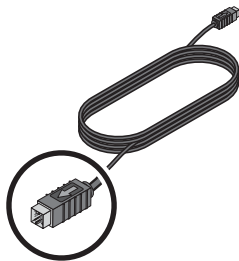

Acoustimass module cable

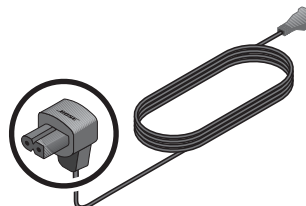

Acoustimass module power cord



Stereo audio cable



HDMI video cable

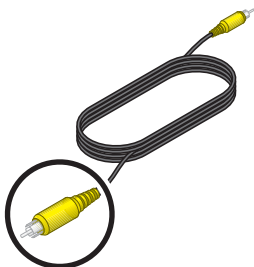

Composite video cable

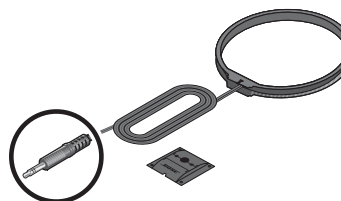

AM antenna and stand

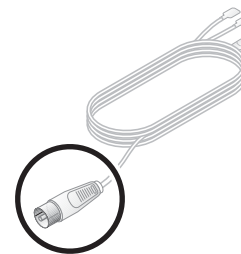

FM antenna

SETUP

1 Placing the system components

What you need to use:

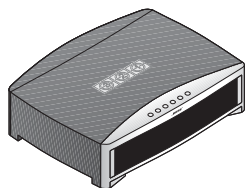

Media center

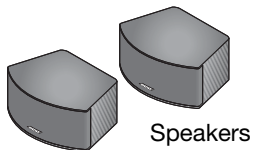

Speakers

OR

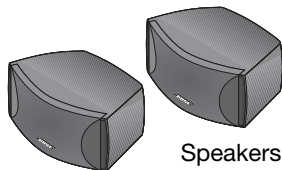

Speakers



Acoustimass® module

The image below shows one of the many ways you can position your new 3•2•1® system.

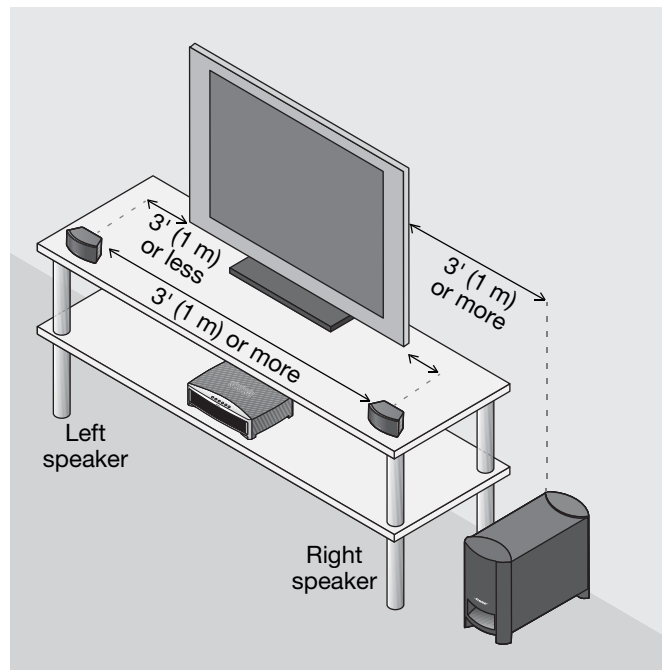

See Steps 1-6 for details.

1. On the bottom of each speaker, attach one set of small rubber feet.

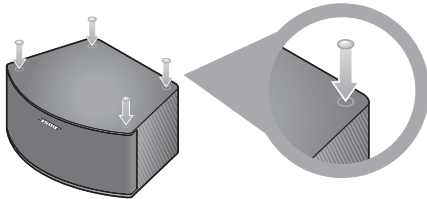

2. Place the left and right speakers:
 - at least 3 feet (1 meter) apart
 - within 3 feet (1 meter) of the TV screen
 - near the front edge of any shelf
 - aimed straight ahead (not angled) to face the listening area
3. On the legs of the Acoustimass® module, attach the large rubber feet.

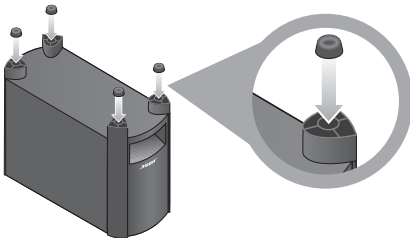

4. Place the Acoustimass module:
 - at the same end of the room as the speakers and your TV
 - at least 3 feet (1 meter) from the TV to prevent interference with the screen
 - several feet (.8 meters) from audio or video tapes to prevent magnetic damage to them
 - standing upright, not lying on a side, the front, or the back
 - with the front port aimed out from or along a wall for balanced performance
 - hidden under a table, behind a sofa or chair, or behind drapes as preferred
 - NOT in an enclosure, on a bed, on a sofa, or on a surface that can block the ventilation openings.

CAUTION: Do not block ventilation openings on the bottom and rear of the module.

5. Place the media center:
 - where nothing obstructs the front panel
 - near any components you will connect
6. Continue with **2** on the next page.



SETUP

2 Connecting the speakers to the module

What you need to use:

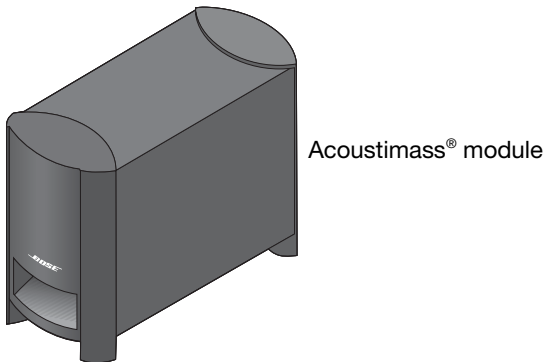
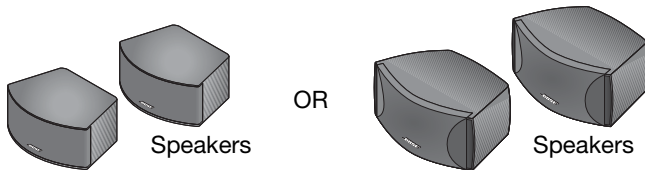

1. Notice the two plugs at one end of the speaker cable.

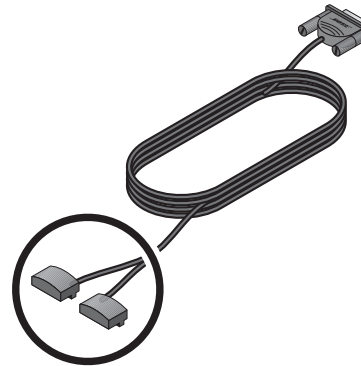

2. Separate the two plugs so each one reaches a speaker.

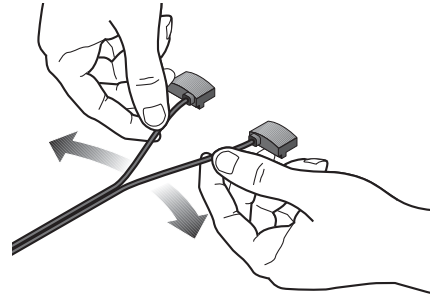

(Refer to **1** for placement guidelines.)

3. Insert each plug into the connector on the proper speaker.

The plug marked RIGHT goes into the speaker placed to the right of your TV.

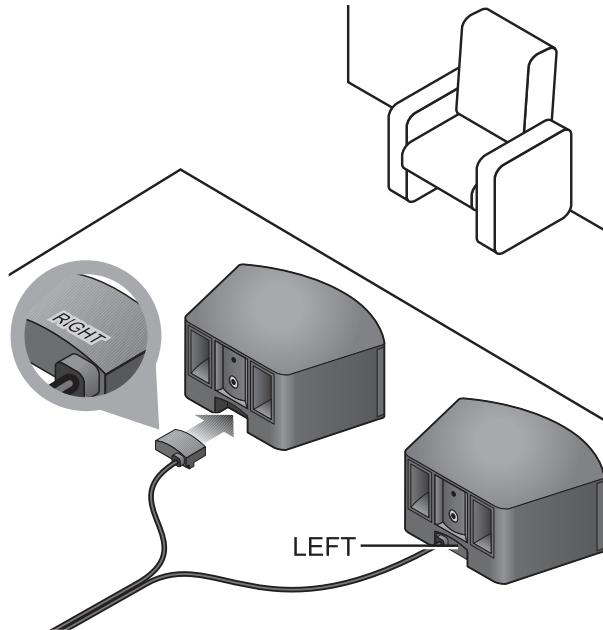

4. Insert the remaining single plug into the connector labeled SPEAKERS on the back of the Acoustimass® module.

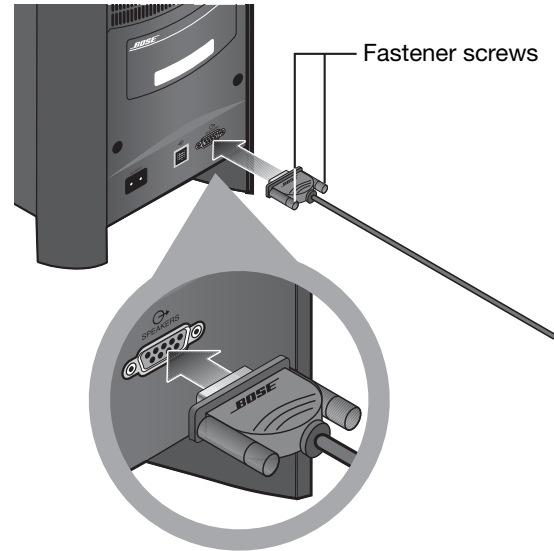

5. Tighten each fastener screw by hand to secure the plug.

CAUTION: Do not plug the Acoustimass module into an AC power (mains) outlet until all other components are connected.

6. Continue with **3** on the next page.

SETUP

3 Connecting the module to the media center

What you need to use:

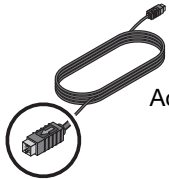

Acoustimass® module cable



Media center

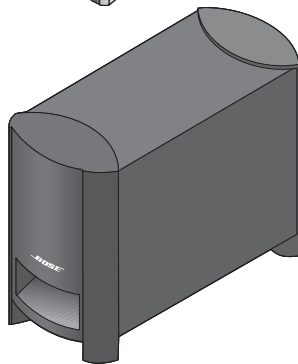

Acoustimass module

1. Notice the arrow on the top of the multi-pin plug at each end of the Acoustimass module cable.

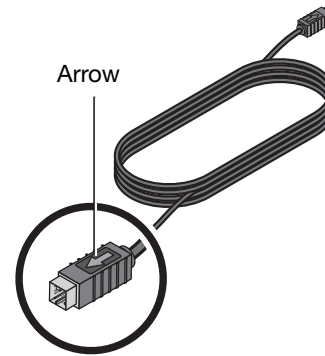

2. Make sure you can see the arrow on top before you insert either end of the cable.

3. Insert this plug into the connector labeled  on the back of the Acoustimass® module.

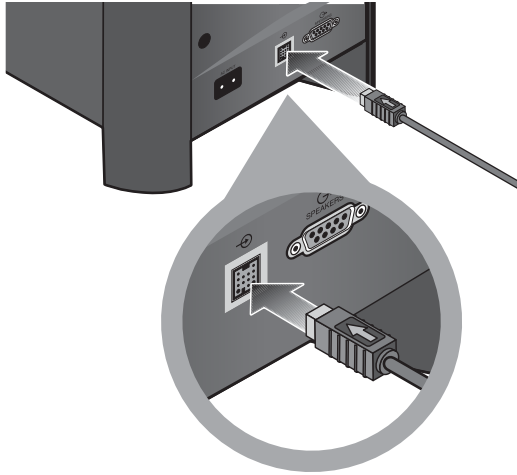

Make sure the arrow on the plug faces up as you insert it.

4. On the other end of the cable, make sure you can see the arrow on top of the plug.
5. Insert this plug into the connector labeled Acoustimass Module on the back of the media center.

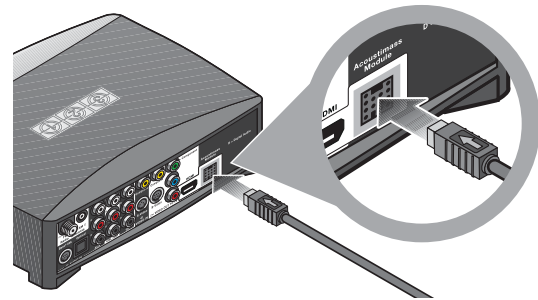

6. Continue with **4** on the next page.

SETUP

4

Connecting the system video to your TV

What you may need to use:



HDMI
video cable

OR

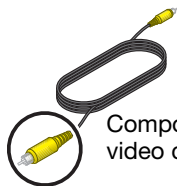

Composite
video cable



Media center

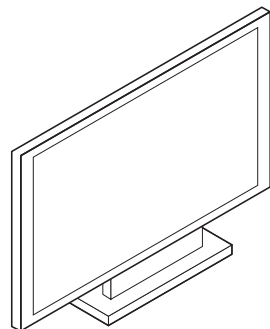

Your TV

This connection allows you to see DVDs and other video from the 3•2•1® system on your TV.

1. Select the HDMI video cable.



2. Check to see if your TV has an unused HDMI connector for VIDEO IN.

This may be located on the side or rear connector panel of the TV.

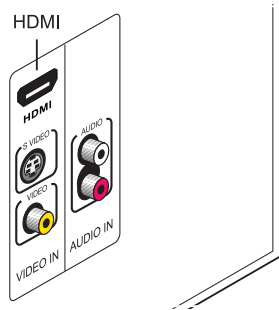

3. Follow the directions that are appropriate for your TV:

TV with HDMI

on page 14

or

TV without HDMI

on page 15

SETUP

TV with HDMI

1. Insert one end of the HDMI cable into the HDMI connector on your TV.

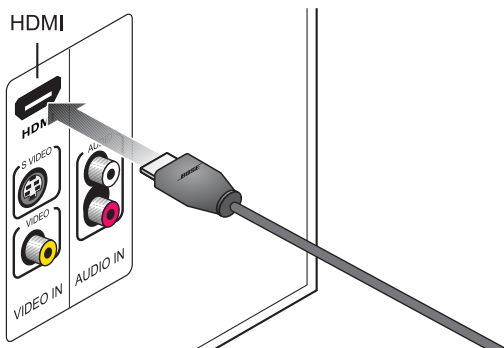

Match the wide side of the plug to the wide side of the connector.

2. Insert the other end of this cable into the HDMI connector on the media center.

Make sure the Bose® logo shows as you insert the plug.

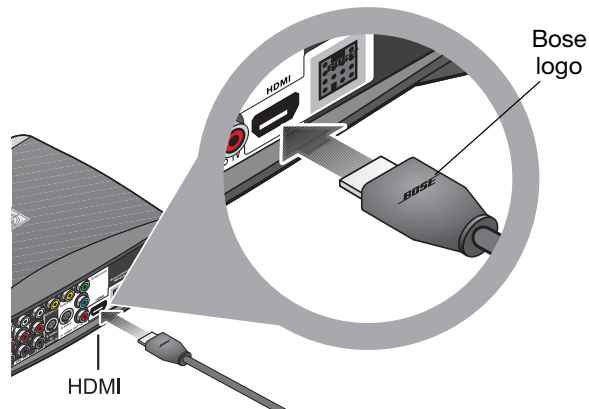

3. Continue with **5** on page 17.

Note: If you make this HDMI connection, you do not need the supplied yellow Composite video cable to make any connections.

DO NOT use either of the two ONLY PASS-THROUGH connectors on the back of the media center for video from a component. Neither S-Video nor Composite signals can pass through the HDMI cable to the TV.

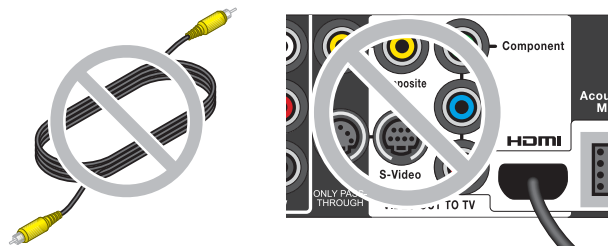

TV without HDMI

1. Notice the yellow plug at each end of the Composite video cable.

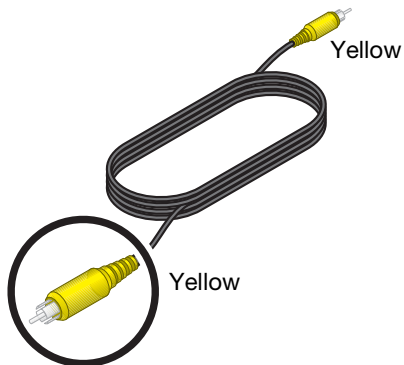

Note: There may be other kinds of video connectors on your TV that offer higher resolution than Composite. To use either S-Video or Component connectors, you need the appropriate cables. These cables are available at most electronics stores.

2. Plug the Composite video cable into the yellow VIDEO IN connector on your TV.

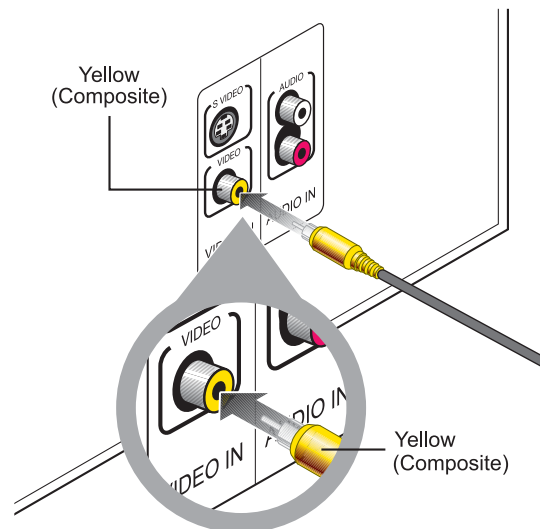

Note: If there is just one Composite Video In connector on your TV, it may be in use already for another video component. You can disconnect that component from the TV, and see "To use video pass through" on page 21.

SETUP

3. Insert the other end into the yellow Composite VIDEO OUT connector on the back of the media center.

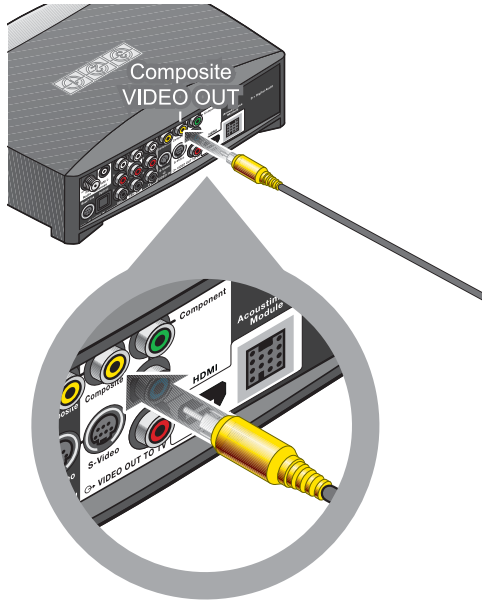

.a

Note: If you make this Composite connection, you can use the *ONLY PASS-THROUGH* connector on the media center for video from another component. See “To use video pass through” on page 21 for further information.

4. Continue with **5** on the next page.

5 Connecting a cable box or other component

What you need to use:

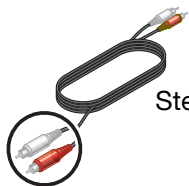

Stereo audio cable



Media center

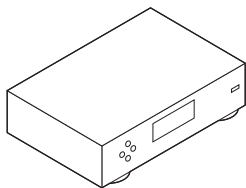

Your cable box, satellite box, or other component

You can listen to another sound source — like a cable or satellite box — through the 3•2•1® speakers instead of your TV.

This requires an audio connection only. Leave the video from your component connected to your TV.

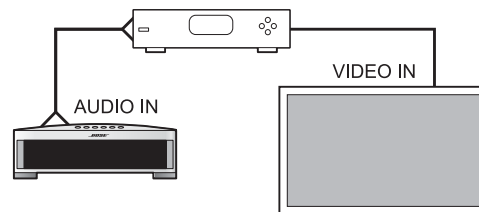

5. Select the audio cable that has red and white plugs at each end.

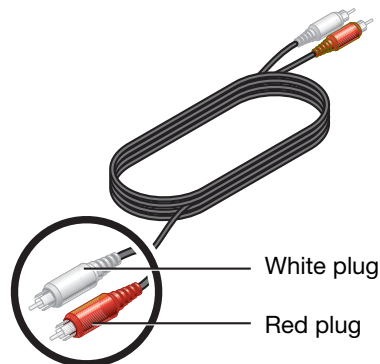

SETUP

6. Check to see if your cable or satellite box has red and white AUDIO OUT connectors.

A red and white audio cable may (a) or may not (b) already be attached to these connectors.

a.

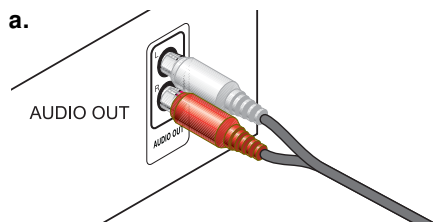

OR

b.

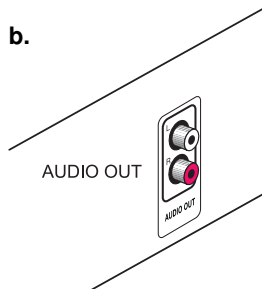

- c. If there are no AUDIO OUT connectors at all, continue with **6** on page 22.

3. To use the AUDIO OUT connectors, follow **a** or **b** as appropriate.

a. If an audio cable is already attached

Disconnect the cable from the TV only.

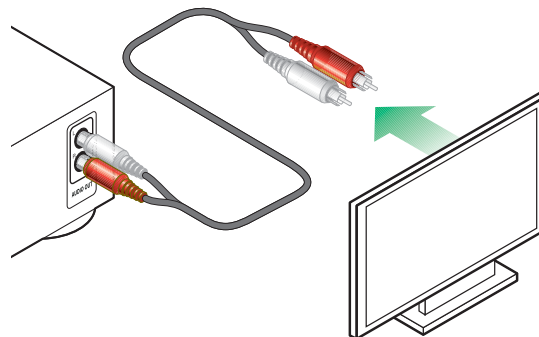

b. If an audio cable is not yet attached

Connect the cable to your cable or satellite box. Be sure to connect red to red and white to white.

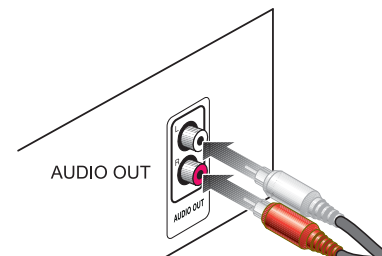

4. Insert the plugs at the other end of the audio cable into the CBL•SAT AUDIO IN connectors on the media center.

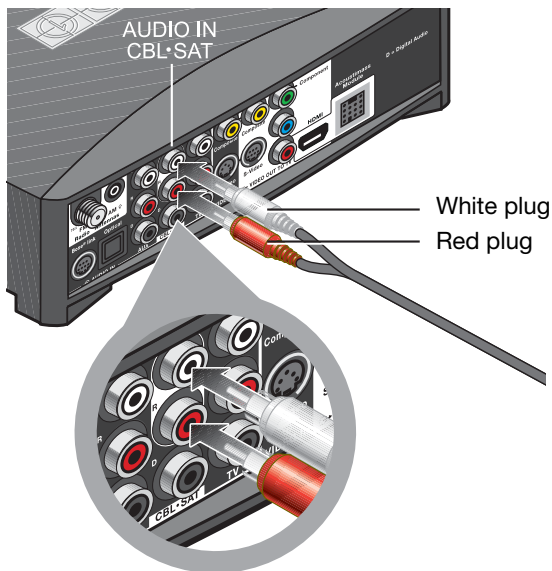

To connect another component

In addition to your cable or satellite box, you can connect a second component, like a VCR. For this you need another audio cable with red and white plugs, available at most electronics stores.

1. Use this additional cable to connect to the AUDIO OUT on your component. Follow the method used in steps 1-3 on the previous pages.
2. Connect the other end of this cable to the AUDIO IN AUX on the 3•2•1® system media center.

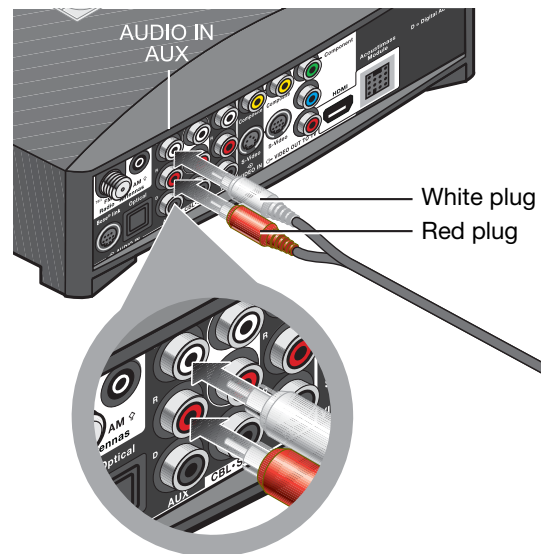

SETUP

To get digital audio from the component

For a component that is already connected to the media center, you can make a digital audio connection too.

For this higher quality audio, you need a digital audio cable that works with your component. Such cables are available at most electronics stores.

1. Identify the digital connector on your component as either an Optical or Coaxial connector.

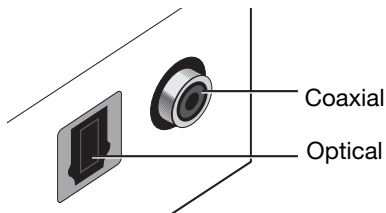

2. Be sure to use the right cable for this connector.

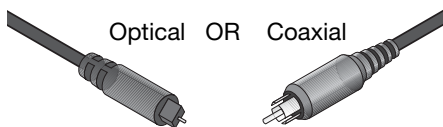

Note: If your component has an Optical and a Coaxial connector, use either one but not both.

3. Connect one end of your digital cable to the digital AUDIO OUT connector on your component.

Be sure to keep the red and white audio cable connected. This allows you to hear the audio if the program audio is not digital or the digital signal is interrupted.

4. Locate the appropriate digital AUDIO IN connector, labeled D, on the system media center.

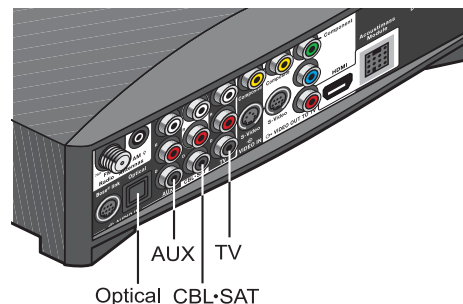

You can make:

- up to 3 coaxial connections
- up to 2 coaxial and one optical connection

Note: The media center Optical connector is factory set to work with a cable or satellite box. If your Optical component is neither of those, you need to select your component in an on-screen System menu. See “Getting digital audio from a source” on page 45.

5. Plug the other end of your digital cable into the appropriate AUDIO IN connector on the media center.

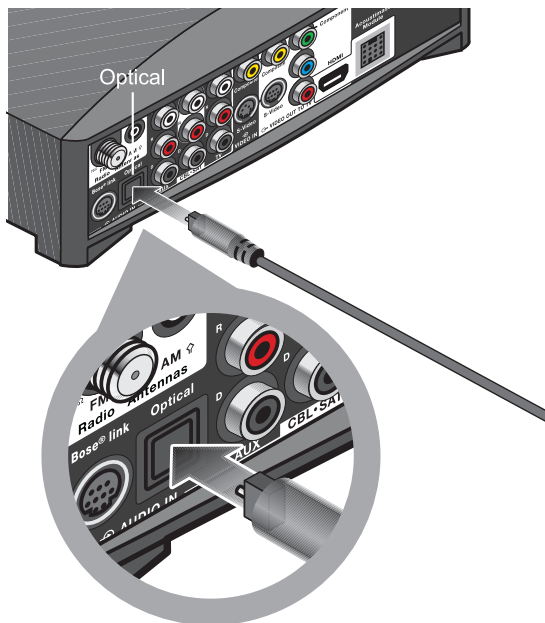

The example here shows an Optical digital connection only.

To use video pass through

This calls for another composite cable or two S-Video cables, which are available at most electronics stores.

You can make a pass through connection if:

- You have a Composite or S-Video connection between the TV and the media center (not HDMI or Component).

AND:

- You want to connect another video component through the media center to the TV.

Be sure to use one matched pair as shown here:

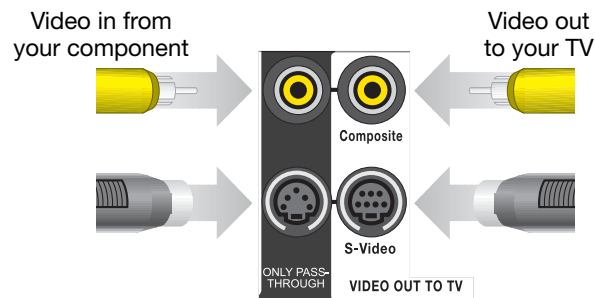

DO NOT use either of the two ONLY PASS-THROUGH connectors (on the left) if you have made an HDMI or Component connection VIDEO OUT TO TV.

Continue with **6** on the next page.

SETUP

6 Connecting audio from your TV as an option

What you need to use:

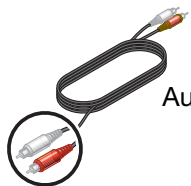

Audio cable



Media center

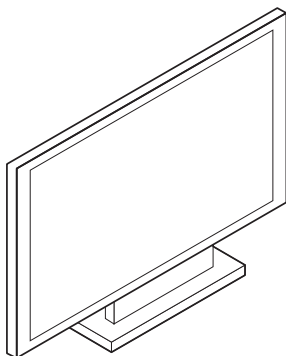

Your TV

For some setups, in order to hear your TV sound from your 3•2•1® speakers, you need to make this connection.

If:

- Your cable box does not provide red and white AUDIO OUT connectors.
- You watch TV programs without using a cable or satellite box.
- You connect a video camera or game console to your TV.

If none of the above apply, continue with **7** on page 25.

Note: If you have already connected the audio cable provided with the system, you need another cable for this connection. These cables are available at most electronics stores.

1. Insert the red and white plugs at one end of the cable into the AUDIO OUT connectors on the TV.

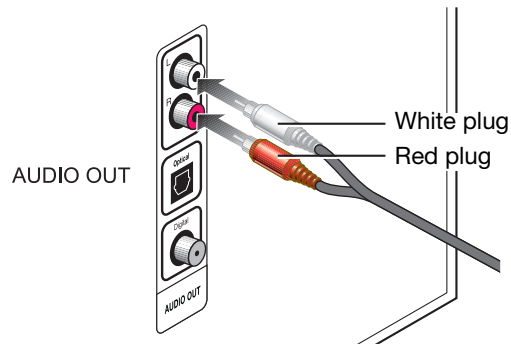

Be sure to match red to red and white to white.

Note: In addition to this connection, you can make a digital AUDIO OUT connection from the TV to the media center. For more information, review “To get digital audio from the component” on page 20.

Note: If your TV does not provide AUDIO OUT connectors, you cannot connect the TV audio to the 3•2•1® system. Continue to use your TV speakers for TV program audio.

The audio from other components that are connected to the 3•2•1 media center will play through the 3•2•1 speakers.

SETUP

2. Insert the red and white plugs at the other end of this cable into the AUDIO IN TV connectors on the media center.

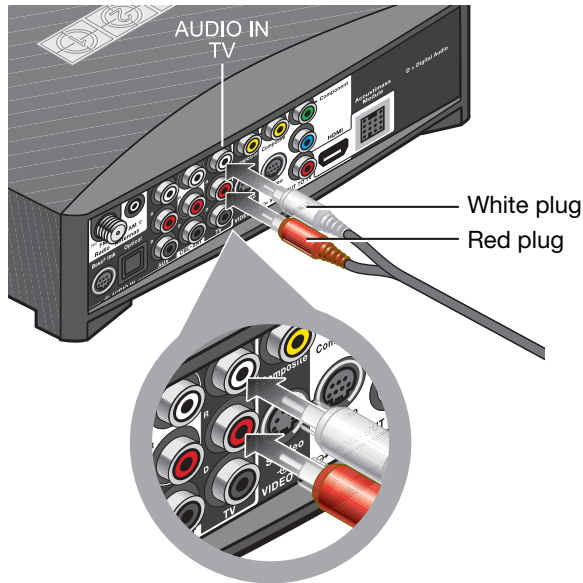

Be sure to match red to red and white to white.

3. Use your TV remote control to turn the TV speakers down to minimum volume.

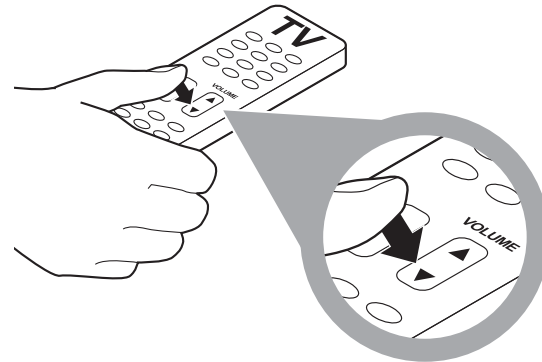

This prevents the echo effect of audio playing through both the TV speakers and your 3•2•1® system speakers.

7 Installing the FM and AM radio antennas

What you need to use:

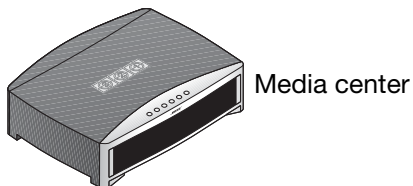
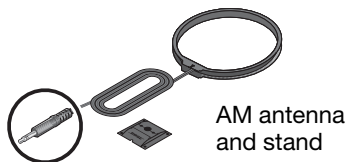

For radio reception of broadcast radio programs, you need to use the supplied antennas.

For FM:

1. Select the FM antenna.

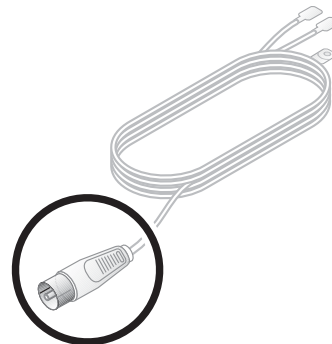

2. Insert the antenna plug into the FM antenna connector.

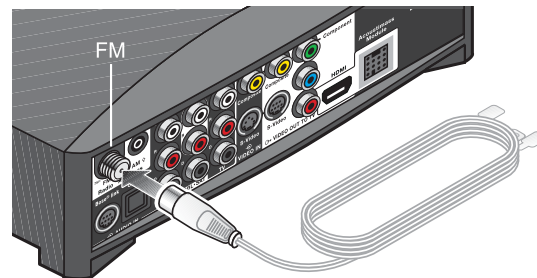

SETUP

3. Straighten the antenna cable and spread the two ends far apart.



You may need to raise the ends and adjust the position to get clear reception.

For AM:

1. Select the AM antenna and stand.

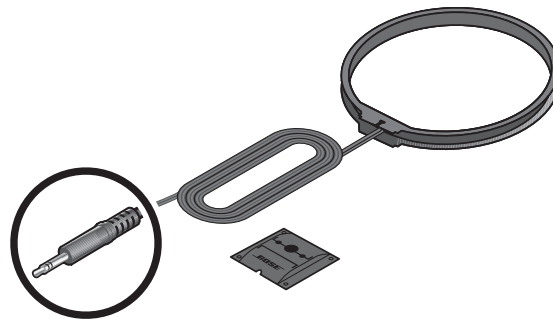

2. Insert the antenna plug into the AM antenna connector.

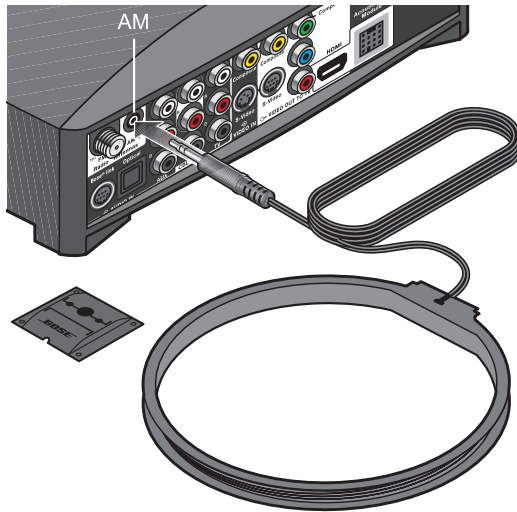

3. Press firmly to attach the antenna loop to the provided stand.

Small tabs on the antenna ring fit into notches on the stand.

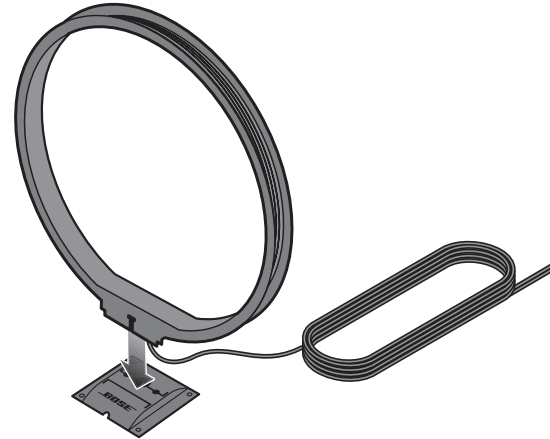

4. Place the antenna in an upright position and at least 20 inches (50 centimeters) from both the media center and the Acoustimass® module.
5. Continue with **8** on the next page.

SETUP

8

Connecting the module to a power outlet

What you need to use:



1. Notice the large plug at one end of the Acoustimass module power cable.

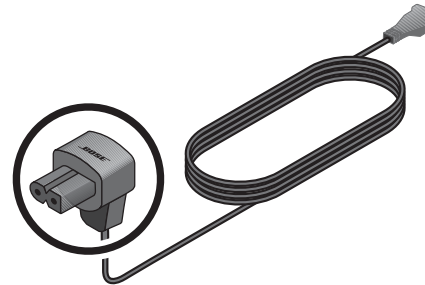

Acoustimass module

2. Insert this plug into the power connector that is marked ~ on the Acoustimass® module.

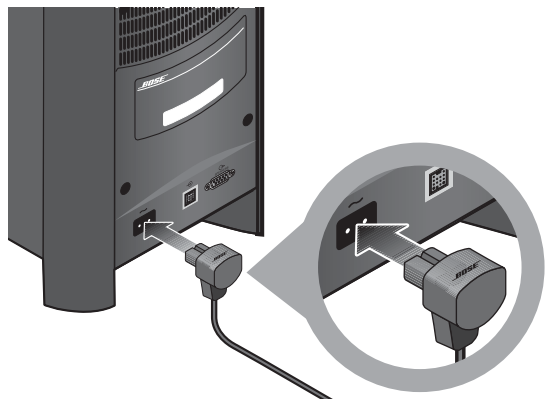

Note: On some systems, the Acoustimass module includes one of two controls.

On 220-240V models only, turn the POWER switch to on (I).



On dual-voltage systems only, set the voltage switch for the power that is appropriate to the region where you use the system.



3. Plug the other cable end into the AC (mains) power.

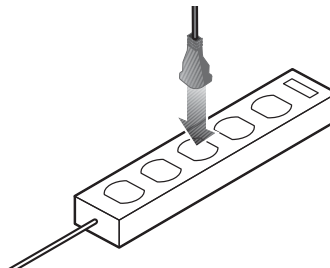

CAUTION: Bose recommends using a safety agency-approved surge protector on all electronic equipment. Voltage variations and spikes can damage electronic components in any system.

Note: Surge protectors are available at most electronics stores.

4. Continue with **9** on the next page.

SETUP

9

Setting the remote to control your TV and components

What you need to use:



Remote control and batteries

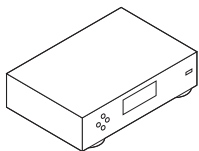

Your component

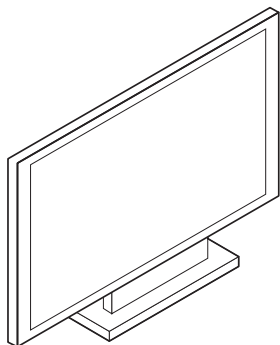

Your TV

When the batteries are installed, you can set the 3•2•1® remote to control your TV and other components connected to the media center.

Inserting the remote batteries

The two supplied AA batteries go into the compartment on the back of the remote control.

1. Slide the battery compartment cover off.

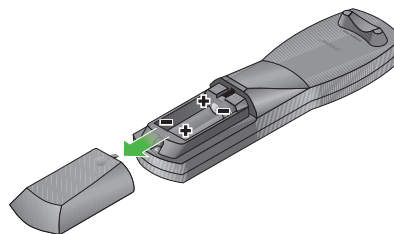

Symbols inside the compartment show how to match the – and + symbols on the batteries.

2. Insert the two batteries, making sure to match the markings.

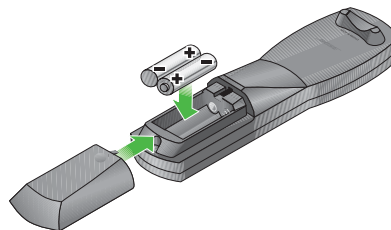

3. Slide the cover back until it clicks into place.

Setting the remote for your TV

To use the 3•2•1® remote with your TV, you must set the remote for the proper TV device code.

1. Refer to the list of “Device codes” on page A-1.
2. In the list for TVs, find the brand of your TV.
3. Write down several codes for your brand so you can try more than one, if needed.

Note: *If one code works to turn your TV on and off but does not change channels, you can try other codes to find one that provides more complete TV control.*

4. Turn on the TV and your 3•2•1 system.

5. On the 3•2•1 remote, press and hold the TV button for several seconds.



Wait until the red light at the top of the remote turns on.

6. Use the number buttons on this remote to enter the device code for your TV.

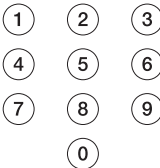

The light turns off briefly as you press each key.

7. Make sure the light turns off completely after all digits are entered.

If the light blinks now, the code is invalid. Return to step 5 and try a different code for your TV.

8. Point the 3•2•1 remote at your TV and press the TV On/Off button.

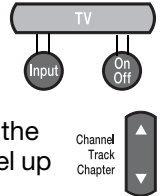

Use the 3•2•1 remote to turn the TV on again and change channels, using the number buttons or by pressing Channel up or down.

If it performs both operations, this code is correct. Write the code numbers below:

If this code does not work, repeat steps 5-8 using a different code for your TV.

Note: *For a CD changer or combination CD/DVD player and changer, your brand may not be listed in the CD/DVD device codes on page A-21. In some cases, the same brand of DVD or VCR device codes can work with a changer.*

SETUP

Controlling another component

With your CBL•SAT, VCR, or other component turned on, follow these steps.

1. In the Device Codes list, find the codes for the type and brand of your component.

2. On the 3•2•1® remote, press and hold the button for this component for several seconds.



Wait until the red light at the top of the remote turns on.

3. Enter the device code for your component.

The light turns off briefly as you press each key.

4. Make sure the light turns off completely after all digits are entered.

If the light blinks instead of turning off, the code is invalid. Return to step 2 and try a different code for your component.

5. Point the 3•2•1 remote at your component and press the On/Off button for this source.

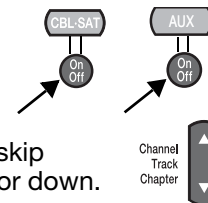

Use the 3•2•1 remote to turn the component on again and to skip forward by pressing channel up or down.

If it performs both operations, this code is correct. Write the code numbers below:

If this code does not work, repeat steps 2-5 using a different code for your component.

Trying out the DVD

When you first turn on the system, you can play the provided DVD to get a step-by-step review of your setup.

1. Before you continue, make sure that:
 - All of the cables needed for your setup are connected.
 - Batteries are installed in the 3•2•1® system remote control.
 - The system power cord is plugged in at both ends.
2. Turn on your TV.
 - Use the TV On/Off button on the 3•2•1 remote if you have it set up to control your TV.
 - Or use the remote control that came with the TV.
3. Play the provided DVD.
 - a. Point the 3•2•1 remote control at the media center and press CD/DVD.

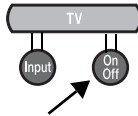

- b. On the media center controls, press Eject.
- c. Insert the disc into the disc tray.
- d. Press Eject again to close the tray and begin automatic play.
- e. If the DVD does not begin playing, press the play button on the remote.

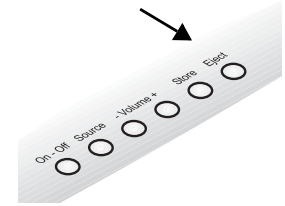

Playing the DVD helps verify that your system setup is correct.

Note: If you do not see the DVD video on your TV screen, change the Video Input on the TV.

Use the TV Input button on the 3•2•1 remote if you have it set up to control your TV.

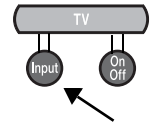

Or use the button for Video Input on your TV remote control. For more information, refer to the owner's manual that came with your TV.

If you STILL do not see the DVD image on your screen, see the problem identified as "Sound, but no picture" under Troubleshooting on page 62.

CONTROLS AND INDICATORS

The remote control

Aim the 3•2•1® remote control at the media center or at the component you are controlling with the remote.

1. Press the white On/Off button near the top of the remote control.

The system turns on to the last used source*, which may be:

- CD•DVD
- FM•AM
- TV
- CBL•SAT
- AUX

If your media center does not respond to the remote:

- Make sure there is nothing blocking the front display where signals are received.
- Aim more directly at the media center.
- Move closer to the system.
The control range of the remote is roughly 20 feet (6.2 meters).

**If your 3•2•1 system is connected by Bose® link cable to a Lifestyle® system in another room, your Lifestyle® system could be the selected source.*

2. Get to know how the remote works:
 - See the brief descriptions on pages 35-38.
 - Try out the various buttons to see how they work.



Power and source buttons



Turns the 3•2•1® system on and off.
Play begins with the source last used.



Silences or restores the sound.



Selects the built-in CD/DVD player as source and turns on the system.



Selects the built-in FM/AM radio as source and turns on the system to the station last used.

Switches between FM and AM when the radio is playing.

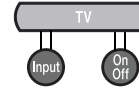



Selects audio from the TV source and turns your 3•2•1 system on if it was off.

If the remote is set up control your TV:

- Input selects a TV Video Input.
- On/Off turns the TV on and off.

Your remote also provides one of the two buttons shown here:

- For adjusting the on-screen aspect ratio of video from cable, satellite, or TV (but not DVD). 
- For displaying teletext information that is provided with broadcast programs (in Europe only). 



Selects the audio from the device connected to CBL•SAT on the media center rear panel.

Turns your 3•2•1 system on if it was off.

If the remote is set up to control this source, On/Off turns the cable or satellite box on and off.



Selects the audio from the device connected to AUX on the media center rear panel.

Turns your 3•2•1 system on if it was off.

If the remote is set up to control this source, On/Off turns the AUX device on and off.

CONTROLS AND INDICATORS

Menu and movement buttons



Settings

Enters the Settings menu for the source that is playing.



System

Enters the System main menu.



DVD Menu

Displays the DVD menu for the current disc on your TV screen.



Guide

Displays an on-screen program guide for any connected video devices that provide a guide.



Exit

Exits the 3•2•1® Settings or System menu.
Exits the on-screen menus or information screens of other connected video sources.



Page

Moves ahead or back by one page in an electronic program guide, if one is available.

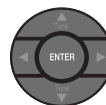

Confirms the selection of a menu item.



Moves up, down, left, or right in a menu or screen.

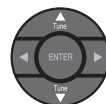

Tunes the FM/AM radio up or down to the next frequency.

Selects the next or previous item in a menu list.



Volume

Raises or lowers the volume.

- Pressing + raises the volume and unmutes the system (if muted).
- Pressing – lowers the volume.

Channel
Track
Chapter

Skips backward or forward to the next:

- TV, cable, or satellite channel
- CD track
- DVD chapter

Play and numeric buttons



Halts play of recorded music or video.



Pauses or resumes paused play of recorded music or video.



Starts or resumes play of recorded music or video.



For CD or MP3: Moves to the previous or next track.

- Press and hold scans through a track.

For DVD and DVR: Moves backward or forward in video.

- More presses increase the speed.

For FM/AM: Moves to the previous or next strong radio station.



For CD: Randomly plays the music.

- Pressing again ends random play.

For DVR: Moves backwards a few seconds with each press.



For CD or MP3: Repeats the current track.

- Pressing again repeats the disc.
- Pressing three times ends the repeat.

For DVR: Moves forward a few seconds with each press.



For CD: Selects a track.



For DVD: Selects a chapter.

For TV, cable, or satellite: Selects the channel of the numbers pressed.



For FM/AM: Selects a preset radio station.



Info

For CBL•SAT: Displays or dismisses an on-screen information window (if one is available).

For MP3: Holding down the button displays or dismisses artist and title information on the media center display panel.







Previous

For TV, cable, or satellite: Returns to the channel last selected.

CONTROLS AND INDICATORS





Record and A, B, C buttons (not in Europe)

These buttons can be used with a DVR, VCR, a cable box, or satellite box. This requires that the 3•2•1® remote is set to control the component.

-  Starts DVR or VCR recording of the cable, satellite, or TV program that is playing.
-  Makes a selection from a cable on-screen List A.
-  Makes a selection from a cable on-screen List B.
-  Makes a selection from a cable on-screen List C.

Colored buttons (in Europe only)

These buttons can be used with Teletext, a cable box, or a satellite box (if the 3•2•1 remote is set to control the box).

-  Red – Selects the screen content labeled red.
-  Green – Selects the screen content labeled green.
-  Yellow – Selects the screen content labeled yellow.
-  Blue – Selects the screen content labeled blue.

The media center

The front of the media center features:

Control buttons

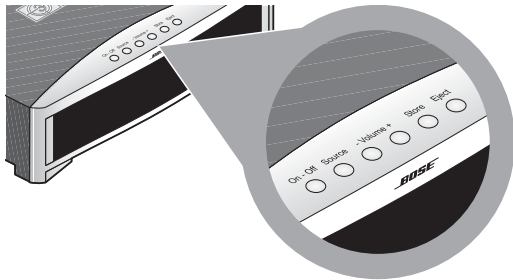

On•Off	Turns the system power on or off.
Source	Displays and sets the choice of play options.
- Volume -	Lowest or raises the volume level.
Enter	Selects the next available radio preset.
Eject	Opens or closes the disc tray.

Note: When you use the Source button on the media center to select a connected component for play, your 3•2•1® remote will not control that component. Press the CBL•SAT or AUX button on the remote to control that source.

Display

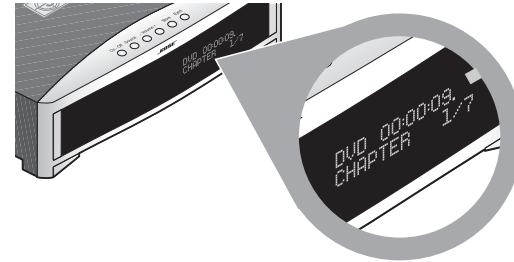

When the system is turned on, the display shows:

- selected source (CD/DVD, for example)
- source status (stopped, for example)
- source data (elapsed DVD time, for example)
- system status (like disc tray OPEN, shown below)

Disc tray

Use the Eject button to open and close this tray. Do NOT push the tray to close it.

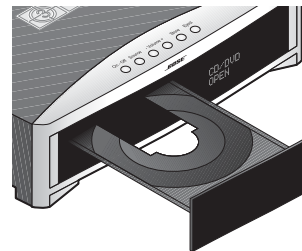

OPERATION

Playing a video disc or CD

1. Press CD•DVD on the 3•2•1® remote.

This turns on the 3•2•1 system and selects the CD/DVD source.

For video play, also turn on the TV.

You may need to change the TV Video Input to see the correct video.

Note: To prevent mid-play video disc problems, be sure the disc is clean. This is particularly important with rented DVDs.

2. On the media center control panel, press Eject to open the disc tray.

3. Place the disc (right side up) in the tray.

4. Press Eject again to close the tray.

The disc begins to play automatically.

If not, press Play on the 3•2•1 remote.

The media center display registers disc information and progress as the play continues.

Note: If the display text is not in your language, see “Language choices” on page 48.

Note: There are several ways to select a TV Video Input:

- If your 3•2•1 remote is set to work with your TV, press the TV Input button.
- If the remote is not set to work with your TV, use the Input button on your TV remote control. Or see your TV owner’s guide for instructions.

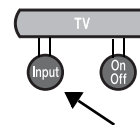

Selecting a play option

If you want to:

Interrupt play, press Pause on the remote control.



- To resume playing a paused disc, press Pause again. Or press Play.



Halt play, press Stop.



- To resume playing a stopped disc, press Play.
- To restart the disc at the beginning, press Stop once more and then press Play.



Skip to the next CD track or DVD chapter, press Chapter up.



Skip to the previous CD track or DVD chapter, press Chapter down.

Replay part of the disc, press Repeat.

- Press once to replay the CD track or DVD chapter.
- Press twice to replay a CD disc or DVD title.
- Press three times to end the replay.



Scan backward or **forward** through the disc, press and hold Seek reverse or Seek ahead.



Press Play to end the scan.



Stop a disc **and open** the disc tray, press Eject on the media center.

Keeping your discs clean

Scratches or dirt on a disc can prevent it from playing properly.

To avoid this problem:

- Handle discs by their edges to prevent fingerprints and scratches. Return them to their cases after use.
- Avoid exposing discs to:
 - chemical products that can cause damage.
 - writing directly on the disc or on a label attached to the disc.
 - direct sunlight, high temperatures, and humidity
- Use a soft, dry and lint-free cloth to clean the disc. Wipe straight out from the center to the edge.

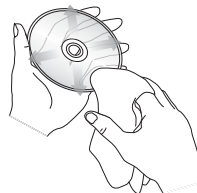



Do not use
a circular
motion



OPERATION

Checking for disc compatibility

If you have trouble playing a disc, check to be sure it is one of the compatible types below.

- Video DVD 
- Video CD 
- DVD-R, DVD-RW
- Audio CD 
- CD-R
- SACDs (CD-compatible content only)
- MP3 CDs:
 - burned in a single closed session
 - in disc format ISO9660
 - with .mp3 as the extension and no other periods in the file name.

Region codes

For any DVD player and DVD disc to work together, the code for the region where they were sold must match. A code symbol is marked clearly on the bottom of your system media center and on the DVD cover (where it may be very small). For example, Region 1 is .

Copy protection

Music and other content may be protected by international and domestic copyright laws and may contain specific restrictions on use and/or reproduction. Please respect the rights of the artists and other copyright holders.

For DVDs: Setting Parental Control

You can password protect some DVDs that are not appropriate for other family members.

Choosing a password

1. Turn on your TV and your 3•2•1® system.
 - Be sure to select the same TV Video Input that you use to watch a DVD.
2. Press the System button on your 3•2•1 remote control.
 - The System menu appears on screen.
3. Press the right arrow button to select the DVD Lock icon .
4. Press ENTER.
5. Use the number buttons to create your four-digit password.

Setting a restriction level

1. Choose a Parental Control Setting from the chart of ratings defined by the Motion Picture Association of America (MPAA).

Ratings supplied by the MPAA

Parental Control Setting	MPAA Rating	Audience Restriction
8		None
7	NC-17	Adult audiences
6	R	Mature audiences
5		Mature teenage audiences
4	PG-13	Teenage audiences
3	PG	Mature young audiences
2		Most audiences
1	G	General

The numbers above the one you select will be restricted.

2. In the System menu, select DVD Lock and enter your password.
3. Use the arrow buttons to reach Lock UnRated Discs and select Yes.
4. Move down to Lock Discs Rated Above and right to the numbers.
5. Press the up or down arrow button to select a number.
Any numbers above this selection will be restricted by password protection.
6. Press ENTER to save this setting and Exit to move out of the System menu.

OPERATION

Playing a cable box or other component

1. Press the button for the source (CBL•SAT or AUX) you want to play.

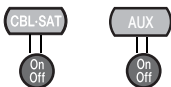

This turns on the 3•2•1® system to the selected source.

2. Turn on your component and, if it is a video source, turn on the TV.

If the 3•2•1 remote is set to control the component, you can press the source On/Off button on the remote.

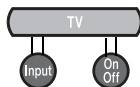

3. Choose the proper Video Input on your TV if the source is a video component.

Adjusting for audio delay

While playing a DVD, you may notice that the picture and audio are not in perfect sync. For example, you see a person's lips move after you hear the words.

To make small adjustments to this timing, use the audio delay setting on the 3•2•1 system:

1. Press the Settings button on the 3•2•1 remote control.
The Settings menu appears on screen.
2. Move down to the audio delay icon  and press ENTER.
3. Select an adjustment (1-8) and wait to see if this corrects the problem.
Each selection makes a minute timing adjustment. It may be difficult to notice the change.

Getting digital audio from a source

For an Optical digital audio connection to the media center, the connected component must be recognized by the system.

Currently, the system is set to recognize CBL•SAT as the Optical component.

If the Optical connection is for a different component:

1. Display the 3•2•1® system menu on the TV by pressing System.
2. Move right to the Media Center icon  and press ENTER.
3. Move down to Optical Source and press ENTER.
4. Move up or down to select a component from the list and press ENTER.
5. Press Exit to leave the System menu.

Note: When using your 3•2•1 system with the TV, turn the volume on your TV set all the way down. This prevents an echo effect from two sets of speakers playing.

Choosing other options

The 3•2•1 system provides optional settings and adjustments to meet your specific needs.

For example you can:

- Set a countdown time for the system to turn off automatically.
- Choose another language for text on the media center display and in system menus.
- Adjust the bass or treble audio compensation.
- Change the image format on your TV screen.

Note: Your TV may provide an on-screen menu to make changes to the video image.

For a full list and description of these options, see “Adjustments to the performance” on page 47.

OPERATION

Listening to the radio

Your 3•2•1® system includes an FM and AM radio.

1. On the 3•2•1 remote, press FM•AM.



This turns on the 3•2•1 system and plays the radio station last selected.

2. Press the FM•AM button to switch between FM and AM.

3. Press the Channel up or down buttons to tune from one station to another.



To tune to:

- A preset station, press the Preset number button.
- The next clear station, press a Seek button.

Creating a preset

You can assign a preset number for 20 FM and 20 AM stations. Then, by pressing the preset number, you tune immediately to the particular station:

1. Tune to the station you want to assign to a preset.
2. Choose the number you want to assign to that station.

3. Press and hold the chosen number button:

- For numbers 1 through 9, press and hold the button.

PRESET:x* SET appears briefly on the media center display.

- For numbers 10 through 20, press the first number, then press and hold the second number.

PRESET:xx* SET appears briefly on the display.

Removing a station from a preset

1. Press the number of the preset.
2. Listen to be sure this is the preset you want to erase.
3. Press and hold zero.

PRESET:xx* ERASED appears briefly on the display.

**x represents the number you select.*

ADJUSTMENTS TO THE PERFORMANCE

Changing system features

If your system operates as you want it to, you may not need any changes.

Some kinds of setup, however, require a change for optimal performance. In most cases, you make a System change just once.

The features that you can change include:

- Audio
- Video
- Media Center
- DVD Lock

Using the DVD Lock feature is described in “Playing a video disc or CD” on page 40.

For details on the other options available, refer to the tables on the pages that follow.

To get to the System menu

The System menu appears on your TV screen only.

1. Turn on your 3•2•1® system.
2. Turn on your TV and select the TV Video Input that you use to watch a DVD.
3. Press the System button on your 3•2•1 remote.
The System menu appears on your TV screen.
4. To get into the menu, move right and select an icon (like Media Center, shown on page 48) for one of the system features.
The list of options appears on the menu screen.

Note: *Entering the System menu pauses a DVD or CD.*

ADJUSTMENTS TO THE PERFORMANCE

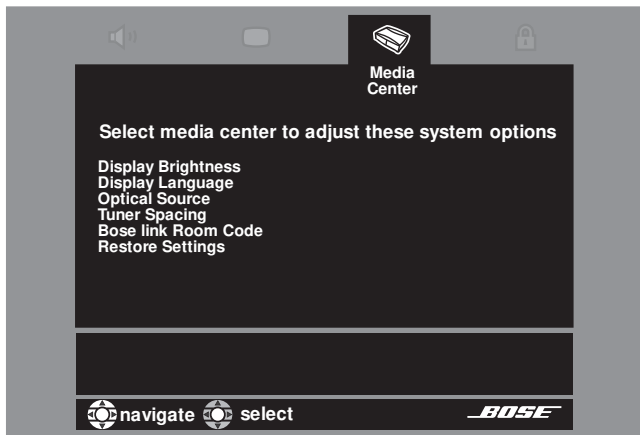

Selecting a new option

1. Make sure you see the System menu on your TV screen.
2. Move right to select the system feature you want to change and press ENTER.
3. Press the up and down buttons to move to the option you want.
As explanation for each options appears at the bottom of the menu when you highlight the option by moving up or down.
4. Press ENTER to select the option.
5. Change the option by selecting a new setting (or by pressing number buttons, as needed).
6. Press Exit to leave the System menu.

Language choices

You can select the language you prefer to see on-screen and on the media center display. To make this change, move to the Display Language option in the Media Center feature of the System menu.

Audio options

These options affect the way the system sounds in your home.

Option	Default Setting (Options)	Description
Bass Compensation	0 (-14 to +14)	Zero is for standard low-tone performance. – decreases and + increases these low tones.
Treble Compensation	0 (-14 to +14)	Zero is for standard high-tone performance. – decreases and + increases these high tones.
Audio Processing	Automatic (User Adjustable)	Keeps Bose® processing as the standard. Allows some processing options (Movie EQ, Range Compression, Mono Decoding) to appear in Settings menus.
Input Levels: TV Analog Input Level TV Digital Input Level CBL•SAT Analog Input Level CBL•SAT Digital Input Level AUX Analog Input Level AUX Digital Input Level	Normal (-6, -3, +3, +6)	Decreases or increases the volume level setting for the input of a connected component. This minimizes abrupt volume changes when you switch from DVD or FM•AM audio on the Bose media center to audio from a connected component. Note: To match AM and FM levels, which can vary depending on the program or station, adjusting the volume on your audio component may be preferable.
DVD Audio <i>(Only for TVs connected to the media center by HDMI cable.)</i>	Bose 3•2•1 (TV Stereo)	Plays the DVD audio from 3•2•1® media center over the 3•2•1 speakers. Sends two channels of DVD audio by HDMI cable to the TV and plays this sound on the TV speakers as well as on the Bose® speakers.

ADJUSTMENTS TO THE PERFORMANCE

Video options

These options affect the way the picture looks on your TV.

Option	Default Setting (Options)	Description
<p>Widescreen TV</p> <p>Note: If your TV is connected using an HDMI cable, you may not see a choice of settings.</p>	<p>Yes (16:9) (No 4:3)</p>	<p>Yes tells the system that widescreen (16:9) is the TV format.</p> <p>No tells the system that 4:3 is the TV format.</p> <p>For a TV connected using a Composite, S-Video, or Component cable, selecting No also makes available the DVD Image option (below).</p> <p>Note: If you are not sure what type of cable is used to connect your TV, check the Video Connector indicator, which is explained on page 51.</p>
<p>DVD Image</p> <p>Note: This option is NOT available UNLESS you have selected No in the Widescreen TV option (above) for your TV connected using a Composite, S-Video, or Component cable (not HDMI).</p>	<p>Modified (Original)</p>	<p><u>For a TV connected using an HDMI cable:</u></p> <p>Modified allows the Bose® system to automatically provide the resolution that is preferred for your TV (usually 720 or 1080), so the image fills the screen. You can change this video resolution in the Settings menu.</p> <p>Original tells the Bose® system to keep the image in the original DVD format (in 480 or 576 resolution), regardless of how it fills the screen. No change can be made to this video resolution in the Settings menu.</p> <p>(Some TVs determine automatically how to fill the screen, overriding any choice.)</p> <p><u>For a TV connected using non-HDMI cable:</u></p> <p>Modified allows the Bose system to adjust the images on some <u>widescreen</u> DVDs to fill a 4:3 TV screen. This is done by removing the black bars on top and bottom and by cropping the sides of the image. (Many DVD images, even widescreen, will still appear with black bars on top and bottom.)</p> <p>Original tells the Bose system to keep the image in the original format of the DVD. A <u>widescreen</u> DVD image will have black bars on top and bottom.</p>

Option	Default Setting (Options)	Description
Video Connector <i>(Only an indicator.)</i>	(HDMI) (Composite + S-Video) (Component)	Identifies the type of video connection made on the back panel of the media center. This is not an adjustable setting.
Video Black Level <i>(Appears on screen only if the TV connects to the media center using a Composite or S-Video cable.)</i>	Normal (Extended)	Screen black level generally appropriate for most TVs. Darkens the intensity of the black on screen.
TV Video Format	NTSC - US (PAL - EUROPE) (MULTISTANDARD)	Correct for NTSC (U.S. standard) monitors. Correct for PAL (European standard) monitors. Only for a TV that supports multiple formats (NTSC and PAL).
Progressive Scan <i>(Appears on screen only if the TV connects to the media center using a Component cable. It is not needed with HDMI.)</i>	Off (On) Note: <i>If selecting On distorts your screen, press the remote up arrow to reselect Off.</i>	Screen image repaints in standard style. Screen image repaints in advanced style (if your TV provides this option). Note: <i>With an HDMI connection, you will not see the On option. The HDMI cable automatically senses your TV capabilities and applies progressive scan as appropriate.</i>

ADJUSTMENTS TO THE PERFORMANCE



Media center options

These options affect general operation of the system.

Option	Default Setting (Options)	Description
Display Brightness	4 (1 to 4)	Media center display shows text at its brightest. Choosing a lower number darkens text on the display.
Display Language	English (Dansk, Deutsch, Español, Français, Italiano, Nederlands, Svenska)	On-screen display menus appear in the selected language.
Optical Source	CBL•SAT (TV, AUX)	Set for a component connected by Optical cable to the CBL•SAT AUDIO IN on the 3•2•1® media center. Identifies a different component connected by Optical cable to the media center.
Tuner Spacing	US (European)	Applies the regional standard for incremental spacing between AM and FM stations.
Bose Link Room Code	B (C, D, E, F, G, H, I, J, K, L, M, N, or O)	Links the 3•2•1 system to a unique code so it works with Bose® link as a second room sound source. Bose link expansion is a Lifestyle® system feature.
Restore Settings	No (Yes)	Maintains your established changes in the Settings menu. Returns all of your selections in the Settings menu to the original factory settings.

Choosing new settings

You can use the 3•2•1® Settings menus for quick adjustments while you watch a video or listen to music.

For example, if you want to change the screen resolution for DVDs, you will find that option in the TV Settings menu.

To see these options, enter the Settings menu for the selected source. Symbols and definitions for the options that are offered appear on screen.

Note: *Some of the settings made while you are playing a particular source are temporary. When you change sources or turn off the system, these settings revert to the factory selections.*



To get to the Settings menu



1. Use the 3•2•1 remote to select the audio or video source that you want to change.
2. Press the Settings button.
The Settings menu that affects this source appears on your media center display.
It also appears on screen if your TV is on and you select the proper TV Video Input.
3. Move up or down to the option you want and press ENTER.
4. Move right to select a new setting for that option and press ENTER.
5. Press Exit to leave the Settings menu.

The Settings menu appears as a vertical bar of icons. To familiarize yourself with the icons, see “Settings options” on pages 54-59.







ADJUSTMENTS TO THE PERFORMANCE



Settings options

	Features	Default Setting (Options)	Effect
	<p>Audio Delay</p> <p><i>Available only for DVDs and connected video components.</i></p>	<p>0</p> <p>(0, 1, 2, 3, 4, 5, 6, 7, 8)</p>	<p>Each number change adjusts the delay by about 30 milliseconds.</p> <p>The most noticeable mismatch in the video and audio synchronization (caused by the video processing in some TVs), occurs in scenes with people talking.</p> <p>If they appear to finish sentences before their lips stop moving, select a different Audio Delay setting to correct this condition.</p>
	<p>Movie EQ</p> <p><i>Available only if Audio Processing is set to Adjustable in the Audio System menu. (Not available for CD or FM-AM.)</i></p>	<p>Off</p> <p>(On)</p>	<p>Leaves the equalization of the movie soundtrack as originally recorded.</p> <p>Adjusts the equalization of the movie soundtrack to better suit some home theater installations.</p> <p>Note: To turn on Movie EQ, the Audio Processing option in the System menu must be set as User Adjustable.</p>
	<p>Range Compression</p> <p><i>Available only if Audio Processing is set to Adjustable in the Audio System menu. (Not available for CD or FM-AM.)</i></p>	<p>Off</p> <p>(On)</p>	<p>Leaves the volume range of the movie soundtrack as originally recorded.</p> <p>Reduces the volume range of sounds on a movie soundtrack.</p> <p>Late at night or at other quiet times, the startling difference between the quietest and loudest audio passages in a movie can be a problem. Turning this feature On moderates those effects.</p> <p>Note: To turn on Range Compression, the Audio Processing option in the System menu must be set as User Adjustable.</p>



	Features	Default Setting (Options)	Effect
	<p>Mono Decoding</p> <p><i>Available only if Audio Processing is set to Adjustable in the Audio System menu. (Not available on CD or FM-AM.)</i></p>	<p>Off</p> <p>(On)</p>	<p>When one-channel (mono) is the audio input, this mono signal is sent to both speakers.</p> <p>Processes the signal from one-channel (mono) audio input (if it is detected) for right and left channel output.</p>
	<p>Audio 1 + 1</p> <p><i>Available only if a dual mono signal is detected on a video CD or digital broadcast.</i></p>	<p>1</p> <p>(2, Both)</p>	<p>Allows you to decode and play bilingual audio from a VCD or single-channel digital broadcast.</p> <p>When the digital audio content is on two channels, each channel carries a unique mono soundtrack (1 + 1).</p> <p>Changing this setting allows you to hear the audio on mono channel 2, or both mono channels at the same time.</p>
	<p>Video Resolution</p> <p><i>Adjustable only for a TV connected by HDMI AND only if the DVD Image setting in the System menu is Modified.</i></p>	<p>_____ * Default</p> <p>(1080p, 1080i, 720p, 480/576p, 480/576i)</p>	<p>Your 3•2•1® system sets its DVD video resolution to match the default that is communicated to it by the TV. You can experiment with other settings to see which one provides the best picture.</p> <p>HDTVs can accept different resolutions as input, and in some cases the highest number does not result in the best picture.</p> <p>Important note: When you change resolution, your TV screen takes several seconds to make the transition. Allow for this adjustment before pressing other buttons.</p>

ADJUSTMENTS TO THE PERFORMANCE

	Features	Default Setting (Options)	Effect
	Time (For DVD only.)	_: _ (0:00)	Changing the elapsed time moves to a different point in the DVD.
	Title (For DVD only.)	_ of _	Changing the first number moves to a different title on the current disc. Some DVDs do not allow direct access to titles.
	Chapter (For DVD only.)	_	Changing this number moves to a different chapter on the current disc. Some DVDs do not allow direct access to chapters.
	Audio Track (For DVD only.)	Dependent on disc	Gives you a choice of audio tracks on the current disc.
	Subtitle Language (For DVD only.)	Dependent on disc	Gives you a choice of subtitle languages (if several are included on the disc).
	Camera Angle (For DVD only.)	1 of _	Gives you a choice of camera angles (if several are included on the disc).

	Features	Default Setting (Options)	Effect
	A-B Repeat <i>(For DVD only.)</i>	A, B	Repeats a segment of the DVD after the start and end points are defined. To begin: <ol style="list-style-type: none"> 1. Move backward or forward to the point in the DVD where you want the segment to start. 2. Press ENTER. 3. Move to the point where you want it to end. 4. Press ENTER. Repeats until you select this setting option again and press ENTER.
	Track <i>(For CD only.)</i>	__ of __	Changing this first number moves to a different track on the current disc.

ADJUSTMENTS TO THE PERFORMANCE

	Features	Default Setting (Options)	Effect
	Sleep Timer	Off (10-90)	Setting countdown minutes causes your 3•2•1® system to turn off when the time reaches 0. The choices, from 10 to 90 minutes, are divided into 10-minute increments. To cancel the timer, select Off.
	Output Mode <i>(For FM only.)</i>	Auto (Mono-Stereo)	Allows you to choose stereo or monaural (mono) audio performance by selecting: <ul style="list-style-type: none"> • Auto – The FM tuner will automatically play in stereo if that is available. Otherwise, it will play in mono (single channel). • Mono – The FM tuner will always play in mono. • Stereo – The FM tuner will always play in stereo if available. Otherwise, it plays mono. When you change the tuner frequency, the setting resets to Auto.
	RDS Info <i>(For FM and only on some systems.)</i>	On (Off)	Displays any station and program information that is available from the Radio Data System.

Replacing remote batteries

Replace both batteries when the remote control stops operating or its range seems reduced. Alkaline batteries are recommended.

1. Slide open the battery compartment cover on the back of the remote.

2. Remove both batteries.

Be sure to dispose of the batteries according to the regulations in your area.

3. Insert two AA (IEC-R6) 1.5V batteries, or the equivalent. Match the + and – symbols on the batteries with the + and – markings inside the compartment.
4. Slide the battery compartment cover back into place.

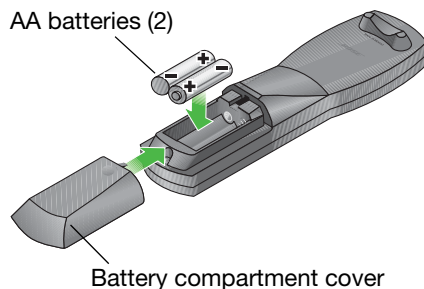

Protecting the system

Follow the guidelines below for keeping the system in good working order.

- Do not allow liquids to spill into any openings.
- Do not use any solvents, chemicals, or cleaning solutions containing alcohol, ammonia, or abrasives.
- Do not use any sprays near the system.

Cleaning the media center

Use only a soft, dry cloth to clean the outside surfaces of the media center.

Cleaning the speakers

Use a soft, damp cloth. Or use an ammonia-free window cleaner on a soft cloth to maintain the finish.

REFERENCE

Troubleshooting

System issues	What to do
System doesn't turn on	<ul style="list-style-type: none"> • Make sure the Acoustimass® module power cord is inserted securely into the AC (mains) power outlet and into the power connector on the Acoustimass module. • Be sure to press a source button (CD•DVD, CBL•SAT, etc.) on the 3•2•1® remote. • Unplug the power cord for 60 seconds, then plug it in again. This allows the unit to reset itself after a power surge or power interruption. • For a 230-240V system (used typically in Europe), make sure the power switch on the Acoustimass module is turned on (I). • For a dual voltage 3•2•1 system only, make sure the voltage setting is correct for your region. If it is set to 115V, the system may not operate in a 230V region. <p>CAUTION: Do not change the voltage switch from 230V to 115V unless you are certain it is appropriate for the power supply in your location.</p>
No sound	<ul style="list-style-type: none"> • Increase the volume. • Check to see if MUTE is lit on the display. If it is, press the Mute button on the remote control to unmute the sound. • Be sure that you have pressed the correct source button (CD•DVD, CBL•SAT, etc.) on the 3•2•1 remote. • Check the audio connections for the component you want to play. • Connect the FM and AM antennas. • Make sure that the cable between the Acoustimass module and the media center is connected securely. • Check connections between the speakers and the Acoustimass module. • Turn off the media center for 60 seconds, then on again, to restore communication between the media center and the speakers.
Sound is distorted	<ul style="list-style-type: none"> • Make sure speaker cables are not damaged and the connections are secure. • Reduce the volume level on the external device playing through the 3•2•1 system speakers.
Sound is marred by a loud hum or buzz	<ul style="list-style-type: none"> • Try plugging your system into a different AC outlet. • Check to see if your media center and its audio input cable are within 3 ft (1 m) of any other electronic or electrical device. Some examples are a TV, cable box, VCR, wireless internet router, dimmer switches, blinking lights, or microwaves. • Move the media center farther away and notice if the humming still occurs.

System issues	What to do
No sound from TV only	<ul style="list-style-type: none"> • If your TV has Variable instead of Fixed audio output, you need to turn off the TV speakers internally. Refer to your TV owner's guide and follow the instructions provided there.
Speech and lip movement on screen are not in sync	<ul style="list-style-type: none"> • Adjust the Audio Delay using the Settings menu on screen. For details, refer to "Choosing new settings" on page 53.
Radio does not work or has poor reception	<ul style="list-style-type: none"> • Make sure the antennas are connected and positioned as shown in "Installing the FM and AM radio antennas" on page 25. • Adjust the FM antenna position to reduce interference. • Move antennas farther from the media center, TV, or other electronic equipment. • Select another station. You may be in an area of weak signal coverage for some stations.
Volume level changes when another sound source is selected	<ul style="list-style-type: none"> • Change the Audio Level for the source input so its volume matches the volume of the radio and DVD in the Bose[®] system. Refer to "Audio options" on page 49.
Remote issues	What to do
3•2•1 [®] remote does not control your TV, CBL•SAT, or AUX component	<ul style="list-style-type: none"> • Make sure that the remote is set to control the component. Refer to "Setting the remote for your TV" on page 31. • Make sure that the front of the component is not obstructed. • Reset the remote using a different device code for the component you want to control. Refer to "Device codes" located at the back of the book. There may be several codes that can turn the component on and off, but only one that provides further control (channel changing, for example).
3•2•1 remote behaves erratically or does not work	<ul style="list-style-type: none"> • Aim the remote at the front of the media center. • Make sure the battery polarity (+ and -) matches the polarity marked in the battery compartment. • Install new batteries. Refer to "Replacing remote batteries" on page 59.

REFERENCE

Video issues	What to do
Sound, but no picture	<ul style="list-style-type: none"> • Make sure the TV is on. • Make sure the TV is set to the correct Video Input to see the video from DVDs on the Bose® system. • Make sure a DVD is in the disc tray. • If the TV is connected to the media center using the HDMI cable: <ul style="list-style-type: none"> – Switch from one Video Input to another and then back to the original input. – Turn everything off, then: <ul style="list-style-type: none"> A. Turn on the TV and set the TV Video Input for the Bose system video. B. Turn on the 3•2•1® system and press DVD. – Turn off both the TV and the 3•2•1 system and then: <ul style="list-style-type: none"> A. Unplug the HDMI cable from both ends. B. Disconnect the power cables from both your TV and the 3•2•1 Acoustimass® module. C. Re-connect power to the television and to the Acoustimass module. D. When the 3•2•1 startup message disappears from the display, re-connect the HDMI cable. E. Turn on the TV first, then turn on the 3•2•1 system. – Disconnect the HDMI cable that connects the TV to the 3•2•1 media center. Reconnect the two using a Component cable, an S-Video cable, or the Composite cable provided with the system.
Incorrect picture for the selected source	<ul style="list-style-type: none"> • Make sure the TV is set to the correct Video Input.
Picture is black and white, flickers, gets dark, or rolls	<ul style="list-style-type: none"> • Check the video cable connections. • If the media center is connected to the TV using a Component cable, make sure the colored cable plugs (red, green, and blue) match the connector colors on the media center and on the TV. • Check the Video Format setting (NTSC or PAL) and change it. Refer to “Video options” on page 50.
Picture is not clear or is unstable	<ul style="list-style-type: none"> • Use the Settings menu to lower the output resolution of the system. Your 3•2•1 system sets its DVD video resolution to match the default that is communicated to it by the TV. You can experiment with other settings to see which one provides the best picture. <p>HDTVs can accept different resolutions as input, and in some cases the highest number does not result in the best picture.</p>

Disc issues	What to do
DVD or CD does not play <i>Note: If you are using the HDMI cable between the TV and media center, there are other possible solutions in “Sound, but no picture” on the previous page.</i>	<ul style="list-style-type: none"> • Make sure the Acoustimass® module power cord is inserted securely into the AC (mains) power outlet and into the power connector on the Acoustimass module. • Check to see if the Play symbol in the display is lit. • After pressing the CD•DVD button, wait a few seconds and press Play. • Make sure the disc is properly inserted (label-side up). • Eject the disc and try loading it again. • Clean the disc to remove fingerprints, dust, or dirt. Refer to “Keeping your discs clean” on page 41. • Try another disc. Some discs are defective and will not play. • Make sure the disc is compatible with the media center disc player. Also make sure the region codes match. Refer to “Checking for disc compatibility” on page 42.
Disc won't eject	<ul style="list-style-type: none"> • Follow these steps: <ol style="list-style-type: none"> 1. Turn off the unit. 2. Unplug the Acoustimass module power cord from the outlet for 60 seconds, then reconnect it. This allows the unit to reset itself. 3. Before powering on, press and hold Eject on the media center.
Lock DVD password lost	<ul style="list-style-type: none"> • Enter the password 2673 to gain entry to the Lock DVD screen.

For customer service

For additional help in solving problems, contact Bose® Customer Service. Refer to the address sheet included in the carton.

Limited warranty

This system is covered by a transferable limited warranty. Details of the limited warranty are provided on the *Product Registration Card* that came with your system.

REFERENCE

Technical information

Power rating

USA/Canada: 120V \sim 60Hz 300W

International: 220-240V \sim 50/60Hz 300W

Dual voltage: 115/230V \sim 50/60Hz 300W

Antennas

FM 75 Ω – external FM antenna

AM – external AM antenna

Maximum ambient temperature

104°F (40°C)

Dimensions

Media center: 3 $\frac{1}{4}$ "H x 13 $\frac{3}{4}$ "W x 10"D
(8.3 cm x 34.9 cm x 25.4 cm)

Remote control: 1 $\frac{1}{8}$ "H x 2 $\frac{1}{2}$ "W x 9"D
(3.0 cm x 6.5 cm x 22.9 cm)

Speakers: 2 $\frac{1}{2}$ "H x 5 $\frac{1}{2}$ "W x 4"D
(6.4 cm x 14 cm x 10.5 cm)

Acoustimass® module: 14 $\frac{1}{2}$ "H x 8 $\frac{3}{4}$ "W x 19 $\frac{1}{8}$ "D
(36.7 cm x 22.2 cm x 48.5 cm)

Weights

Media center: 6.7 lb (3.0 kg)

Speakers: 1 lb (.45 kg) each

Acoustimass module: 23.3 lb (10.6 kg)

Finish

Media center: polymer

Speakers: polymer

Acoustimass module: polymer

4:3 – See “Aspect ratio.”

16:9 – See “Aspect ratio.”

A Analog audio – The sounds that we hear with our ears, unlike digital audio that is encoded as bits of information.

Aspect ratio – An expression for the width of the picture relative to the height. For example, if the aspect ratio is 4:3 (considered a normal screen), the shape of that picture is 4 units wide by 3 units high. The standard TV aspect ratios are 4:3 and 16:9 (called widescreen).

4:3 screen



16:9 screen

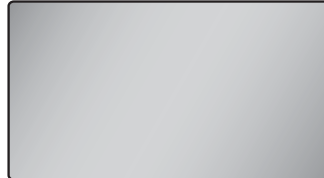

C CD – The abbreviation for a compact disc that stores digitally encoded music that is read by the laser beam in a compact disc player. This provides high-quality playback.

Chapter – A main division of contents in a DVD title.

Coaxial cable – Can carry digital audio signals between a source device and the 3•2•1® system.

Component video – Also called YPbPr for its three-part video signals that include luminance and two color signals. Component video requires the use of a Component cable. This provides considerably better resolution than is possible from either Composite or S-Video signals.

Composite video – The simplest of video signals, which combines black and white with color information. Its low-resolution signal is compatible with the broadest range of televisions and other video components and requires a simple RCA video cable.

GLOSSARY

D Digital audio – Audio in digital form, which is encoded as bits of information.

Dolby Digital – A means of encoding multi-channel audio, developed by Dolby Laboratories and accepted as an international standard.

 – The logo representing Dolby Digital.

DTS – An abbreviation for Digital Theater Systems. DTS encoding provides a type of multi-channel surround sound format used on certain CDs and many DVDs.

 – The logo representing DTS.

DVD – An abbreviation most commonly known to mean digital video disc or digital versatile disc. A DVD looks like a CD but contains high-quality video and multi-channel audio for movies.

DVD-R, DVD-RW – Abbreviations for Recordable (R) and ReWriteable (RW) Digital Video (or Versatile) Disc (DVD). Data can be added to a DVD-R once only, and to a DVD-RW more than once.

DVD-ROM – The abbreviation for Read Only Memory (ROM) on a Digital Video (or Versatile) Disc (DVD), which allows no data to be added.

DVD video – A standard for storing and reproducing audio and video on DVD-ROM discs, based on MPEG video, Dolby Digital audio, and other proprietary data formats.

DVR – An abbreviation for Digital Video Recording (otherwise known as PVR for Personal Video Recording). With a hard drive, an electronic program guide, and internal processing, a DVR simplifies recording and playback of programs.

H HDCP – An abbreviation for High-bandwidth Digital Content Protection. HDCP is a form of Digital Rights Management licensed by Digital Content Protection, LLC, to control digital audio and video content as it travels across Digital Visual Interface (DVI) or High-Definition Multimedia Interface (HDMI) connections. (It prevents unauthorized copying of programs.)

HDMI – An abbreviation for High-Definition Multimedia Interface. HDMI is a de-facto standard interface that delivers clear, all-digital audio and video via a single cable.

HDTV – An abbreviation for High-Definition TV, a digital television format that delivers sharper picture quality with more lines of resolution. HDTV offers a much better picture quality than standard television.

I IR – An abbreviation for infrared. Pertains to the type of remote that sends/receives commands on an infrared light beam.

L Letterbox – A video format that has an aspect ratio wider than 4:3 (refer to Aspect ratio) and is shown with black bars above and below the picture.

M MP3 – This is a compressed audio format (MPEG-1 Layer III) that allows the recording of many hours of music on a single CD.

MPEG – An abbreviation for Moving Picture Experts Group, the committee of experts from the audio, video, and computer industries involved in setting standards for compression of moving images.

N NTSC – An abbreviation for National Television System Committee and the label for its video format standard used for televisions in the U.S. and other countries.

O Optical cable – Carries digital audio via optical fiber between a source device and your 3•2•1® system.

P PAL – An acronym for the Phase Alternate Line video format used extensively in Western Europe.

PCM – An abbreviation for Pulse Code Modulation. A common form of digital audio signal.

Progressive scan – A video format that displays all lines of the picture frame in a single pass and refreshes the TV image 30 times per second. Not compatible with all video displays.

PVR – Refer to DVR.

R RDS – A system that displays radio broadcast station and programming information. This feature is available on European systems only.

Resolution – The sharpness of a video image, signal, or display, generally described either in terms of lines of resolution or pixels.

GLOSSARY

S SCART – A type of connector commonly found on consumer electronics products manufactured for use in Western Europe.

Screen ratio – See Aspect ratio.

Source – Any device that provides audio or video signals for use with the 3•2•1® system. The AUDIO OUT from such a device connects to the AUDIO IN on the media center

S-Video – A video signal that separates the black and white from the color information. S-Video provides higher resolution than Composite video, but not as high as Component video. This type of connection requires use of an S-Video cable.

T Teletext – An information retrieval service provided by television broadcast companies in Europe and some other countries, not including the U.S.

Title – A main component of contents on a DVD. There can be several titles on a DVD, one of which may be a movie.

V Video CD – A compact disc (CD) that contains video.

W Widescreen – A TV having an aspect ratio of 16:9 with a picture shape that is 16 units wide by 9 units high. (Refer to Aspect ratio.)

Y YPbPr – See Component video.

©2008 Bose Corporation. No part of this work may be reproduced, modified, distributed, or otherwise used without prior written permission.

The distinctive design of the 3•2•1® media center is also a registered trademark of Bose Corporation.

Manufactured under license from Dolby Laboratories. “Dolby” and the double-D symbol are trademarks of Dolby Laboratories. Confidential Unpublished Works. ©1992-1997 Dolby Laboratories. All rights reserved.

This product contains one or more programs protected under international and U.S. copyright laws as unpublished works. They are confidential and proprietary to Dolby Laboratories. Their reproduction or disclosure, in whole or in part, or the production of derivative works therefrom without the express permission of Dolby Laboratories is prohibited. ©1992-1996 by Dolby Laboratories, Inc. All rights reserved.

MPEG Layer-3 audio compression technology licensed by Fraunhofer IIS and THOMSON multimedia.



Manufactured under license under U.S. Patent #'s: 5,451,942; 5,956,674; 5,974,380; 5,978,762; 6,487,535 & other U.S. and worldwide patents

issued & pending. DTS and DTS Digital Surround are registered trademarks and the DTS logos and Symbol are trademarks of DTS, Inc. ©1996-2007 DTS, Inc. All Rights Reserved.

This product incorporates copyright protection technology that is protected by method claims of certain U.S. patents and other intellectual property rights owned by Macrovision Corporation and other rights owners. Use of this copyright protection technology must be authorized by Macrovision Corporation, and is intended for home and other limited viewing uses only unless otherwise authorized by Macrovision Corporation. Reverse engineering or disassembly is prohibited.

Consumers should note that not all high definition television sets are fully compatible with this product and may cause artifacts to be displayed in the picture. In case of 525 or 625 progressive scan picture problems, it is recommended that the user switch the connection to the “standard definition” output. If there are ques-

tions regarding your TV set compatibility with this model 525p and 625p DVD player, please contact our customer service center.

Designed with UEI Technology™ Under License from Universal Electronics Inc. ©UEI 2000-2002.

This product incorporates copyright protected technology and other intellectual property rights owned by Cirrus Logic, Inc. and subject to the copyright protection of the U.S. as well as other licensing restrictions and protections. Use of this copyright protected technology is limited solely to use with the Cirrus Logic integrated circuits incorporated in this product. Reverse engineering or disassembly is prohibited.

The Simplay™ logo and the ‘Simplay™,’ and ‘Simplay Labs™,’ trademarks are owned by Silicon Images, Inc. and are used under license from Silicon Images, Inc. and/or Simplay Labs, LLC.

HDMI, the HDMI logo and High-Definition Multimedia Interface are trademarks or registered trademarks of HDMI Licensing, LLC.

DEVICE CODES

TV **A-2**

CBL **A-15**
Cable box

SAT **A-16**
Satellite receiver

CD/DVD **A-21**

DVD **A-21**

VCR **A-26**

A-ACC **A-32**
Audio accessory

V-ACC **A-32**
Video accessory

R-ACC **A-32**
Audio receiver

TV

888	0264, 0412	Aiwa.....	0264, 0032, 0701, 1180, 1904, 1911, 1916	Amplivision	0370, 0217	ART	1037
A-Mark	0047, 0054, 0003, 0009, 0020, 0032, 0039, 0165	Akai.....	0000, 0060, 0812, 0702, 0178, 0030, 0145, 0556, 0037, 0548, 0714, 0606, 0361, 0264, 0218, 0433, 0696, 0729, 0745, 0753, 1935, 0826, 1259, 1537, 1675, 1676, 1903, 0672, 0648, 0602, 0480, 0473, 0412, 0371, 0217, 0208, 0163, 0151, 0056, 0038, 0035, 0009	Ampro	0751	Arthur Martin	0163
A.R. Systems ...	0556, 0037, 0455, 0352, 0374	Akashi	0009, 0860	Amstrad	0000, 0171, 0037, 1037, 0264, 0218, 0433, 0163, 0039, 0177, 0033, 0011, 0362, 0371, 0412, 0648, 0009, 1982	ASA	0070, 0105
Abex.....	0032	Akiba	0037, 0218, 0455, 0282	Amtron	0000, 0180, 0019	Asberg	0037
Accent	0037, 0009	Akira	0418	Anam	0250, 0180, 0037, 0003, 0009, 0628, 0700	Asora	0009
Accuscan	0047, 0018, 0135	Akito	0037	Anam National .	0250, 0037, 0650, 0055	Astar	1531, 1548
Acec.....	0012	Akura	0171, 0037, 0714, 0668, 1037, 0264, 0218, 0009, 0163, 0282, 0412, 1498, 1556, 1982	Andersson	1149, 1163	Astra	0037
Acer.....	1339	Alaron	0170, 0179	Anglo	0264, 0009	Asuka	0264, 0218, 0217, 0282
Acoustic Research	1269	Alba	0037, 0714, 0668, 1037, 0487, 0370, 0218, 0036, 1935, 0474, 0443, 0418, 0371, 0163, 0038, 0032, 0009	Anhua	0051	ATD.....	0698
Action	0030, 0650, 0003, 0019, 0052, 0185	Alcatel	0700, 0843	Anitech.....	0037, 0264, 0009, 0282, 0474	Atlantic	0037
Acura	0009	Alfide	0672	Ansonic.....	0037, 0668, 0370, 0009, 0012, 0163, 0374, 0411	Atori	0009
Addison.....	0653, 0108, 0092, 1150	All-Tel.....	0865, 1269	AOC	0451, 0093, 0180, 0060, 0178, 0030, 0108, 1365, 1150, 1089, 0628, 0474, 0185, 0179, 0157, 0092, 0052, 0039, 0038, 0032, 0019, 0018, 0009, 0003	Auchan	0163
ADL	1217	Alleron	0030, 0170	Aolimpike	0264, 0412	Audinac	0180
Admiral.....	0047, 0054, 0017, 0051, 0093, 0463, 0180, 0264, 0016, 0018, 0019, 0163, 0165, 0179, 0418	Allorgana	0217	Apex Digital.....	0156, 0748, 0765, 0185, 0767, 0879, 0890, 1217, 1943	Audio-Technica	0019
Advantz	0282	Allstar	0037	Apollo	0473	Audiosonic	0037, 0714, 0486, 0264, 0370, 0218, 0009, 0109, 0217, 0374, 0820, 1308
Advent	0761, 0783, 0815, 0817, 0842, 1933	Ambassador	0150, 0177	AR	0556, 0352	Audioton.....	0486, 0264, 0370, 0217
Adventura	0046	America Action	0180	Arc En Ciel.....	0109	Audiovox	1564, 0451, 0180, 0003, 0092, 0179, 0623, 0802, 0875, 1937
Adventuri	0000	American High..	0000, 0060	Arcam	0217	Aumark	0060
Adyson	0032, 0217			Archer	0003	Autovox.....	0217, 0247, 0544
AEG	1163, 1556			Ardem	0037, 0714	Aventura	0171
Agashi	0264, 0217			Aristocrat	0163	AVP	0000
Agna.....	0150			Aristona.....	0556, 0037, 0012	Awa	0451, 0606, 0264, 0036, 0108, 0009, 0011, 0157, 0217, 0374, 1376
Aiko.....	0037, 0361, 0264, 0433, 0009, 0035, 0092, 0217, 0371					Axion	1937
Aim.....	0706, 0037, 0455, 0753					Axxent	0009

Baird	0037, 0109, 0179, 0208, 0217, 0343, 1196	Black Diamond .	1909, 1037, 0614, 0753, 0820, 1163		0355, 0335, 0282, 0217, 0208, 0163, 0009	Changfei	0009, 0374, 0817
Bang & Olufsen	0565, 0619, 1620	Black Star	0247	Byd:sign	1309, 1311	Changfeng	0264, 0412, 0696, 0753, 0817
Baohuashi	0264, 0412	Blackway	0218, 0282	C-Tech	0891, 0896	Changhai	0009, 0817
Baosheng	0009, 0817	Blaupunkt	0195, 0036, 0455, 0170, 0200, 0327, 0535, 0554	Caihong	0009, 0817	Changhong	0156, 0765, 0264, 0508, 0009, 0767, 0783, 0817, 0820, 1156
Barco	0556, 0163	Blue Sky	0556, 0037, 0714, 0668, 1037, 0487, 0009, 0163, 0217, 0282, 0339, 0374, 1163	Cailing	0748	Chengdu	0009, 0817
Basic Line	0556, 0037, 0668, 1037, 0218, 0455, 0009, 0163, 0217, 0282, 0339, 0374, 1163	Blue Star	0282	Caishi	0891	Ching Tai	0003, 0009, 0092, 0179, 0474
Bastide	0217	Bondstec	0247	Candle	0030, 0039, 0046, 0056, 0186	Chun Yun	0000, 0180, 0003, 0009, 0033, 0092, 0179, 0474, 0700, 0843, 1150
Baur	0037, 0195, 0361, 0455, 0146, 0512, 0535, 0544, 0554	Boots	0009, 0217	Capehart	0017, 0178, 0030, 0036, 0003, 0019, 0032, 0046, 00052, 0092	Chunfeng	0264, 0009
Baycrest	0032, 0046, 0186	Boxlight	0893	Capetronic	0030, 0003	Chung Hsin	0180, 0053, 0036, 0108, 0033, 0474, 1150
Baysonic	0236, 0463, 0180	BPL	0037, 0208, 0282, 0896	Capsonic	0264	Chungfeng	0412
Bazin	0217	Bradford	0180	Carad	0668, 1037, 0610	Chunsun	0009, 0817
Beaumarck	0017, 0178, 0030, 0019, 0179	Brandt	0625, 0714, 0560, 0109, 0287, 0335	Carena	0037, 0455	Cimline	0218, 0009
Beijing	0812, 0264, 0226, 0009, 0208, 0374, 0412, 0661, 0817	Brick	0039	Carnivale	0030	Cinema	0672
Beko	0037, 0714, 0195, 1037, 0486, 0606, 0370, 0418, 0808	Brinkmann	0037, 0668, 0486, 0418, 0519	Carrefour	0037, 0036, 0070	Cineral	0451, 0092
Belcor	0030, 0019	Bronvega	0037, 0362	Carver	0054, 0170	Cinex	0648, 1556
Bell & Howell ...	0054, 0017, 0154, 0093, 0016, 0179	Britannia	0217	Cascade	0037, 0009	Citek	0047, 0032
Belson	0698	Brockwood	0178, 0030, 0019, 0056	Casio	0037	Citizen	0054, 0000, 0451, 0463, 0180, 0060, 0030, 0171, 1935, 1928, 0535, 0003, 0016, 0282, 0280, 0186, 0019, 0092, 0020, 0056, 0046, 0039, 0035, 0032
Belstar	1037	Broksonic	0236, 0463, 0180, 0003, 0039, 0177, 1911, 1929, 1935, 1938	Cathay	0037, 0218, 0032, 0474	City	0009
BenQ	1032, 1315, 1562, 1756	Brother	0264	CCE	0037, 0217	Civet	0185
Beon	0037, 0218, 0032, 0039, 0163, 0418	BSR	0163	Celebrity	0000	Clairtone	0185
Berthen	0668	BTC	0218	Celera	0765	Clarion	0180
Best	0370	Bush	0556, 0037, 0714, 0668, 1037, 0698, 0487, 0361, 0264, 0218, 0036, 1259, 1556, 1900, 0661, 0660, 1954, 0614, 0519, 0374, 0371,	Celestial	0767, 0820	Clarivox	0037, 0070, 0418
Bestar	0037, 0370, 0374			Centrex	0706, 0780, 0826, 0891	Classic	0030, 0019, 0056, 0092, 0499
Bestar-Daewoo	0374			Centrum	1037		
Binatone	0217			Centurion	0037		
				Century	0247		
				CGE	0370, 0074, 0163, 0247, 0418		
				Changcheng ...	0051, 0264, 0009, 0374, 0412, 0661, 0817		

Clatronic	0037, 0714, 0264, 0370, 0218, 0009, 0217, 0247, 0371	Curtis Mathes ...	0047, 0054, 0154, 0000, 0051, 0451, 0093, 0180, 0060, 0702, 0178, 0030, 0145, 0166, 0037, 0179, 0466, 1147, 1347, 1919, 0056, 0044, 0039, 0038, 0035, 0032, 0019, 0018, 0016	0019, 0032, 0039, 0056, 0092, 0374	Dream Vision	1704	
Clayton.....	1037	CXC	0180	Dayu.....	0374, 0661	Drean	0037
CMS Hightec....	0217	Cybertron	0218	De Graaf.....	0548, 0044, 0163, 0208	DSE	0698, 0820, 1556
Colortyme	0047, 0054, 0017, 0060, 0178, 0030, 0018, 0019, 0032	Cytron	1326	DEC.....	0891	DTS	0009
Colt	0019	Cytronix	1298	Decca	0037, 0033, 0217	Dual	0037, 1037, 1137, 0217, 0343, 0352, 0394, 0519, 0544
Commercial Sols	0047, 1447	D-Vision	0556, 0037, 1982	Degraff	0163, 0208	Dual Tec	0217
Concerto	0056	Daenyx	0180, 0179, 0672	Deitron	0374	Dumont	0017, 0180, 0178, 0016, 0019, 0032, 0070, 0217
Concorde	0009	Daewoo	0154, 0451, 0180, 0178, 0030, 1661, 0556, 0037, 0634, 1909, 0264, 0218, 0036, 0108, 1928, 0661, 0672, 0700, 1902, 0860, 0865, 1756, 1755, 0880, 1150, 1307, 1598, 0003, 0009, 0019, 0020, 0032, 0039, 0056, 0092, 0109, 0170, 0217, 0374, 0474, 0499, 0623, 0627, 0628	Dell.....	1080, 1178, 1264	Durabrand	0463, 0180, 0178, 0171, 0003, 1034, 1463
Condor	0037, 0264, 0370, 0009, 0247, 0282, 0411, 0418	Dainichi.....	0218	Delphi	0829	Dux	0037, 0012
Conia	0754, 0820, 1498	Dansai	0037, 0036, 0009, 0032, 0035, 0208, 0217	Delta	1369	DVX	0891
Conic	0178, 0032	Dansette	0412	Denko	0264	Dwin	0093, 0720, 0774
Conrac	0808	Dantax	0714, 0486, 0370	Denon	0145, 0038, 0055, 0511, 0576	Dynatech	0217
Conrowa.....	0156, 0145, 0698, 0264, 0009, 0412, 0696, 0753, 1156	Datsura.....	0208	Denstar	0628	Dynatron.....	0037, 0012
Contec	0180, 0037, 0036, 0009, 0157, 0185	Dawa	0037, 0009	Denver	0037, 0587, 1189	Easy Living	1248
Continental Ed.	0487, 0109, 0287	Daytek	0672, 1376	Desmet	0037, 0009	Eaton	0060
Cosmel	0037, 0009	Dayton	0009, 0092	Dewo.....	0628	Ecco	0773
Craig	0180, 0171, 0179, 0282	Daytron.....	0180, 0178, 0030, 0037, 0036, 0009,	Diamant	0037	ECE	0037
Crosley	0054, 0000, 0180, 0030, 0171, 0370, 0074, 0096, 00163, 0187, 0247	DL	0587, 0780, 0872, 0891	Diamond	0706, 0698, 0009, 0371, 0672, 0820, 0825, 0860, 0896	Edison-Minerva	0487
Crown	0093, 0180, 0053, 0037, 0714, 1037, 0486, 0487, 0606, 0712, 0370, 0412, 0418, 0339, 0208, 0672, 00056, 0039, 0009	Domeos	0668	Dick Smith Elec.	0698, 1556	Elbe	0037, 0610, 0218, 0217, 0362, 0411
Crown Mustang	0672	Domland	0394	Digatron	0037	Elcit	0163, 0247
CS Electronics	0218, 0247	Dongda	0009	Digiline	0037, 0668, 0105	Electroband.....	0000, 0185
CTC.....	0247	Donghai	0009	Digital Life.....	0780, 0872, 0891	Electrograph....	1755
CTX	1756			Digitex.....	0820	Electrohome.....	0154, 0000, 0463, 0150, 0178, 0030, 0019, 0032, 0039, 0056, 0151, 0185, 0381

Elin	0037, 0548, 0361, 0009	Feilu	0009, 0817	Fujimaro	0865, 1498	General Tech. ...	0009
Elite	0037, 0218	Feiyue	0264, 0412	Fujitsu	0009, 0179, 0186, 0217, 0352, 0683, 0809, 0853, 1181	Genesis	0037, 0009
Elta	0264, 0009, 0474	Fenner	0009, 0817	Fujitsu General	0009, 0186, 0217, 0683	Genexxa	0037, 0218, 0009, 0163, 0412
Emco	0247	Fer0	0009, 0374	Fujitsu Siemens	0808, 0809, 1163, 1298	Gericom.....	0808, 0865, 0880, 1217, 1298
Emerald.....	0178, 0177	Ferguson.....	0053, 0037, 0625, 0548, 0560, 0195, 1037, 0003, 0109, 0287, 0335, 0343, 0443, 1935	Funai	0000, 0180, 0171, 0668, 0264, 0039, 0179, 0342, 1271, 1904	Giant	0009, 0217
Emerson.....	0047, 0017, 0154, 0451, 0236, 0463, 0180, 0150, 0178, 0171, 0037, 0714, 0668, 0195, 1909, 0486, 0361, 0370, 0036, 0282, 0371, 0623, 1394, 1911, 1928, 1929, 0280, 0247, 0185, 0179, 0177, 0170, 0146, 0135, 0111, 0070, 0044, 0039, 0038, 0032, 0019, 0012	Fidelity	0171, 0037, 0361, 0264, 0163, 0217, 0371, 0412, 0423, 0474, 0512, 0544	Furi.....	0145, 0264, 0412, 0817	Gibraltar	0017, 0000, 0030, 0019
Emperor	0282	Filsai	0217	Furichi	0860	Gintai	0474, 1150
Envision.....	0030, 0019, 0032, 0039, 0813, 1365	Finlandia	0548, 0361, 0105, 0163, 0208, 0346	Futronic	0264, 0860	Go Video.....	0060, 0886
Enzer	0753, 0860	Finlux	0556, 0037, 0714, 0070, 0105, 0163, 0179, 0217, 0346, 0411, 0473, 0480, 0492, 0808, 1556	Futuretech.....	0180	Go Vision	1937
Epson	0833, 0840, 1290, 1322, 1122	Firstar	0236, 0009, 0033	Galaxi	0037	Goldfunk.....	0668
Erres	0037, 0012	Firstline	0556, 0037, 0714, 0668, 1037, 0361, 0009, 0208, 0217, 0247, 0374, 0411, 0544, 0808, 1363	Galaxis	0037, 0370	GoldStar	0047, 0054, 0154, 0178, 0030, 0037, 0714, 0606, 0361, 0036, 0455, 0247, 0474, 1150, 1154, 1378, 1926, 0217, 0163, 0109, 0056, 0044, 0039, 0032, 0019, 0018, 0009
ESA	0812, 0171	Fisher	0047, 0054, 0154, 0000, 0361, 0370, 0036, 0157, 0159, 0208, 0217, 0544	Ganxin	0817	Gooding.....	0487
ESC	0037, 0217, 0474	Flint	0037, 0610, 0264, 0218, 0455	Gateway.....	1755, 1756	Goodmans.....	1163, 0000, 0556, 0037, 0625, 0714, 0560, 0668, 0634, 1909, 1037, 0487, 0264, 0218, 0036, 0587, 0009, 1900, 1376, 1308, 1259, 0335, 0880, 0808, 0011, 0032, 0661, 0035, 0343, 0179, 0217, 0499, 0360, 0480, 0374, 0371
Ether	0030, 0003, 0009	Force	1149	GBC	0218, 0009, 0163, 0374	Gorenje.....	0370
Etron	0009, 0163, 0820	Formenti	0037, 0163	GE.....	0047, 0000, 0051, 0451, 0093, 0180, 0060, 0178, 0030, 1447, 1454, 0625, 0560, 1922, 1919, 1917, 11347, 1147, 0018, 0335, 0282, 0135, 0021, 0092, 0055, 0052, 0027, 0046, 0044, 0038, 0035	GPM	0218
Eurofeel.....	0264, 0217	Fortress	0093	Geloso	0009, 0163, 0247, 0374	GPX	0179
Euroman.....	0037, 0264, 0370, 0217	Fraba	0037, 0370	Gemini	0047	Gradiente	0053, 0037, 0056, 0170
Europa	0037	Friac	0037, 0610, 0370, 0009, 0499	General	0109, 0186, 0287	Graetz	0714, 0487, 0361, 0163, 0339, 0371, 1163
Europhon.....	0037, 0109, 0217	Frontech	0264, 0009, 0163, 0217, 0247, 0474	General Elec. ...	0047, 0021, 0027, 0055		
Evesham	1248						
Evolution	1756						
Expert	0163						
Exquisit	0037, 0247						
Feilang.....	0009						

Gran Prix	0179, 0648		0394, 0499, 0519, 0544, 0661, 0808		0009, 0208, 0696, 0753, 0780, 0860, 1156, 1208, 1314,	Huanghe	0009, 0817		
Granada	0037, 0548, 0560, 0036, 0108, 0226, 0012, 0032, 0146, 0163, 0208, 0217, 0339, 0343, 0473	Hantarex.....	0037, 0009, 0829, 0865	Hitachi	1445, 0047, 0054, 0017, 0000, 0156, 0051, 0150, 0178, 0030, 1145, 0145, 1256, 0037, 0548, 0634, 1037, 1137, 0036, 0108, 0225, 0508, 0719, 0744, 0578, 0576, 0499, 0492, 0481, 0480, 0797, 0877, 1045, 1149, 1150, 1156, 1225, 1245, 1378, 1481, 1576, 1904, 0009, 0016, 0018, 0019, 0027, 0032, 0035, 0038, 0039, 0044, 0055, 0056, 0092, 0105, 0109, 0151, 0157, 0163, 0165, 0179, 0185, 0186, 0217, 0282, 0343, 0381, 0473, 0474		0150, 0108, 0860	Huanglong	0009
Grandin	0037, 0714, 0668, 1037, 0610, 0218, 0455, 0009, 0163, 0282, 0374, 0865, 0880	Hantor	0037			Huangshan	0264, 0009, 0412, 0817		
Gronic	0217	Harley Davidson	0000, 0180, 0060, 0178, 0030, 0019, 0179, 1904			Huanyu	0264, 0217, 0374, 0817		
Grundig	0706, 0556, 0037, 0195, 0487, 0036, 0587, 1954, 1935, 1916, 1376, 1308, 0683, 0672, 0554, 0535, 0443, 0163, 0070, 0009	Harman/Kardon	0054			Huaqiang	0264, 0412		
Grundy	0180, 0195, 0179	Harsper	0865			Huari	0145, 0264, 0412		
Grunkel.....	1163	Harvard	0180			Hugoson	0890, 1217		
Grunpy	0180, 0179	Harwa	0773, 1196, 1269			Huodateji	0051		
H & B	0808	Harwood	0037, 0487, 0009, 0032, 0412			Hygashi.....	0217		
Haaz.....	0706	Hauppauge	0037			Hyper	0009, 0217, 0247		
Haier	0037, 0698, 0587, 0508, 0768, 0891, 0896, 1034	Havermy	0093			Hypersonic	0361		
Haihong.....	0009	HCM.....	0037, 0264, 0218, 0009, 0217, 0282, 0412, 0418			Hypson	0556, 0037, 0714, 0668, 1037, 0486, 0264, 0455, 0217, 0282		
Haiyan	0264, 0412, 0817	Heathkit.....	0017			Hyundai	0753, 0849, 0860, 0865, 1376, 1531, 1556, 1598		
Halifax	0264, 0217	Helios	0865			Iberia	0037		
Hallmark.....	0236, 0180, 0178, 0019, 0135, 0179, 0187	Hello Kitty.....	0451			ICE.....	0037, 0264, 0218, 0217, 0371		
Hampton	0217	Hema.....	0009, 0217			ICeS.....	0218		
Hanimex.....	0218	Hemmermann ..	0544	Hitachi Fujian ...	0150, 0108, 0860	IIsonic.....	1376		
Hankook.....	0180, 0178, 0030, 0019, 0056, 0628	Hewlett Pkd	1494, 1502, 1088, 1089, 1642	Hitec	0698	Iiyama	0877, 0890, 1217		
Hannspree	1348, 1351	Hicon	1467	Hitsu	0610, 0218, 0455, 0009	iLo.....	1603, 1684		
Hanseatic	0556, 0037, 0714, 0634, 0361, 0370, 0009, 0217, 0282,	Hifivox	0109	Hoehner	0714, 0865, 1163, 1556	Ima.....	0236, 0180, 0178, 0179		
		Highline	0037, 0264	Home Elec.	0606	Imperial.....	0037, 0370, 0074, 0247, 0418		
		Hikona	0218, 0474	Hongmei.....	0093, 0264, 0009, 0817	Imperial Crown	0264, 0009, 0374, 0412, 0661		
		Hikone	0218	Hongyan	0264, 0412, 0817	Indiana.....	0037		
		Himitsu	0180, 0628	Hornlyphon	0037, 0012	Infinity	0054		
		Hinari	0037, 0264, 0218, 0036, 0009, 0032, 0096, 0163, 0179, 0208, 0282, 0352, 0355, 0443	Hoshai	0218, 0455, 0282	Ingelen.....	0714, 0610, 0487, 0163		
		Hisawa	0714, 0610, 0218, 0455, 0282	HP	1088, 1089, 1494, 1502, 1642	Ingersol.....	0009		
		Hisense	1363, 0156, 0748, 0145, 0556, 0508,	Hua Tun	0009, 1150	Initial	1603		
				Huaafa	0145, 0009				
				Huanghaimei	0009				

Inno Hit.....	0218, 0009, 0217, 0247, 0282, 1163	JBL	0054	Kamp	0017, 0180, 0019, 0185, 0217	Kolin	0180, 0150, 0053, 0036, 0108, 0033, 0474, 1150, 1331
Innova	0037	JCB	0000	Kanghua.....	0896	Kolster	0037, 0218, 0247
Innovation	0519	JDV	1982	Kangli	0264, 0009, 0374, 0661, 0817	Kongque.....	0264, 0009, 0817
Innowert	0865, 1298	Jean.....	0156, 0051, 0236, 0036, 0003, 0009, 0092, 0179, 0474	Kangyi	0264, 0009, 0412	Konichi	0009
Inotech	0773, 0820	JEC	0035	Kapsch	0361, 0163	Konig	0037
Insignia.....	1564, 0171, 1204, 1326, 1517, 1641, 2002	Jensen	0761, 0815, 0817, 1933	Karcher	0714, 0610, 0606, 0264, 0370, 0282, 1556	Konka	0180, 0037, 0714, 0218, 0587, 0817, 0754, 0720, 0719, 0707, 0703, 0638, 0632, 0628, 0418, 0371, 0282, 0080
Inteq	0017, 0145	Jiahua	0051	Kathrein.....	0556	Kontakt.....	0487
Interbuy	0037, 0264, 0009, 0247	JiaLiCai.....	0264, 0009, 0412	Kawa	0371	Korpel	0037
Interfunk	0037, 0361, 0012, 0109, 0163, 0200, 0247, 0327, 0512	JIL.....	0030, 0019	Kawasho	0030, 0019, 0185	Korting.....	0370, 0039
Internal	0037, 1909	Jinfeng.....	0051, 0226, 0208, 0817	Kaypani	0052	Kosmos	0037
Intervision.....	0037, 0486, 0487, 0264, 0218, 0455, 0009, 0217, 0247, 0282, 0394, 0519	Jinque	0264, 0009, 0412, 0817	KB Aristocrat....	0163	Kost	1262
Irradio	0037, 0218, 0009, 0247, 0371	Jinta	0264, 0009, 0412	KDS.....	1498	Kotron	0412
IRT	0451, 1661, 0698, 0628	Jinxing	0054, 0156, 0145, 0556, 0037, 0698, 0264, 0009, 0817	KEC.....	0180, 0060	Koyoda	0009
Isukai	0037, 0218, 0455, 0282	JMB	0556, 0634, 0443, 0499	Ken Brown	0236, 0463	Kriesler	0012
ITC.....	0217	JNC.....	1964	Kendo	0037, 1037, 0610, 0370, 0247, 0362, 0411, 0519, 0648	KTV.....	0463, 0180, 0030, 0039, 0185, 0217, 0280
ITS.....	0037, 0264, 0218, 0282, 0371	Jocel	0712	Kenia	0030, 0019	Kuaile	0264, 0009, 0412
ITT	0548, 0610, 0361, 0163, 0179, 0208, 0339, 0346, 0473, 0480, 0544	Johnson.....	0455	Kenmore	0146	Kulun	0009
ITT Nokia	0180, 0548, 0195, 0610, 0606, 0361, 0070, 0163, 0179, 0208, 0339, 0346, 0473, 0480	Jubilee	0556	Kennedy	0163	Kunlun	0051, 0264, 0226, 0208, 0374, 0661, 0817
ITV	0037, 0264, 0247, 0374	Juhua	0264, 0412, 0817	Kennex	0668, 1037	Kyoshu	0032, 0412, 0418
IX	0877	Jutan	0030, 0019	Kenwood.....	0180, 0030, 0019	Kyoto	0032, 0163, 0217
Janeil	0046	JVC	1253, 0054, 0093, 0463, 0053, 0030, 0606, 0218, 0036, 0650, 0653, 0508, 0055, 0070, 0371, 0418, 0683, 0731, 1172, 1923	Khind	0706, 0896	L&S Electronic .	0714, 0808, 0865
		Kaige	0264, 0009, 0412, 0817	KIC	0217	Lark	0154, 0386
		Kaisui	0037, 0218, 0455, 0009, 0217, 0282	Kiota	0455, 0371	LaSAT	0486
		Kambrook.....	0217	Kioto	0054, 0706, 0556	Lavis	1037
				Kiton	0037, 0668	Leader	0009
				KLH	0156, 0180, 0765, 0767	Lecson	0037
				KLL.....	0037	Legend	0009
				Kloss	0030, 0024, 0046	Lemair	0032, 0411
				KMC	0003, 0032		
				Kneissel.....	0556, 0037, 0610, 0370, 0362, 0374, 0411, 0499		
				Kobra	1467		

Lenco 0037, 1037, 0587,
 0374, 0474
 Lenoir 0009
 Lesa 0247
 Lexsor 1196
 Leyco 0037, 0264
 LG 1423, 0054, 1265,
 0060, 0178, 0030,
 0556, 0037, 0714,
 0698, 0361, 0370,
 0108, 1305, 1325,
 1378, 1178, 1154,
 0856, 0829, 1637,
 1758, 0700, 1926,
 0644, 0474, 0442,
 0247, 0217, 0163,
 0109, 0056, 0039,
 0038, 0032, 0019,
 0009, 0003
 Liesenk & Tter . 0037
 Liesenkotter 0037, 0012, 0327
 Lifetec 0037, 0714, 0668,
 1037, 1137, 0218,
 0009, 0374, 0519,
 0683
 Lihua 0817
 Lloyd's 0236, 0180, 0030,
 0009, 0032, 0039,
 0056, 0179, 1904
 Lloytron 0032
 Local Chennai TV 0009
 Local India TV . 0264, 0009, 0208,
 0371, 0602
 Local Malaysia TV 0698
 Lodos 1037
 Loewe 0693, 0037, 0370,
 0136, 0512, 0633,
 0790
 Logik 0236, 0180, 0060,
 1037, 0698, 0009,
 0011, 0016, 0033,
 0056, 0179, 0371,
 0773, 0880, 1217

Logix 0668, 0519
 Longjiang 0264, 0412, 0817
 Luker 1982
 Luma 1037, 0009, 0163,
 0362, 0374, 0411
 Lumatron 0556, 0037, 0361,
 0264, 0163, 0217
 Lux May 0037, 0009
 Luxman 0056
 Luxor 0548, 1037, 0361,
 0163, 0179, 0208,
 0217, 0346, 0473,
 0480, 1163
 LXI 0047, 0054, 0017,
 0154, 0000, 0156,
 0051, 0093, 0060,
 0053, 0178, 0030,
 0171, 0166, 0037,
 0036, 0135, 0146,
 0159, 0165, 0179,
 0208, 0280, 0096,
 0056, 0055, 0016,
 0018, 0039, 0038,
 0035, 0032, 0024,
 0021, 0020, 0019
 M & S 0054
 M Electronic 0037, 0714, 0634,
 0195, 0661, 0512,
 0492, 0480, 0411,
 0374, 0346, 0343,
 0287, 0247, 0217,
 0163, 0109, 0105,
 0009
 Macy 0039, 0046, 0186
 Madison 0037
 MAG 1498
 Magnadyne 0054, 0024, 0163,
 0187, 0247, 0544
 Magnasonic 0054, 0000, 0156,
 0093, 0030, 0003,
 0019, 0056, 0092,
 0109, 0179, 1928

Magnavox 0047, 0054, 0154,
 0000, 0250, 0051,
 0180, 0060, 0030,
 0171, 1454, 0706,
 0037, 0036, 1931,
 1904, 1755, 1525,
 1365, 1254, 1198,
 0802, 0780, 0729,
 0386, 0282, 0011,
 0187, 0186, 0019,
 0179, 0020, 0111,
 0096, 0092, 0024,
 0035
 Magnum 0037, 0714, 0648,
 1289
 Majestic 0017, 0016
 Mandor 0264
 Manesth 0037, 0264, 0035,
 0217
 Manhattan 0037, 0668, 1037
 Maqma 1467
 Marantz 0054, 0030, 1454,
 0556, 0037, 0412,
 0704, 0854, 0855,
 1154, 1398
 Mark 0037, 0714, 0009,
 0217, 0374
 Maruman 0627
 Master's 0499
 Mastro 0053, 0706, 0698,
 0780
 Masuda 0037, 0264, 0218,
 0009, 0217, 0371
 Matsui 1163, 0556, 0037,
 0714, 0195, 1037,
 0487, 0036, 0455,
 0433, 1916, 0744,
 0544, 0443, 0371,
 0355, 0352, 0335,
 0217, 0208, 0177,
 0163, 0056, 0039,
 0035, 0033, 0011,
 0009
 Matsushita 0250, 0051, 0650

Matsuiama 0587
 Maxdorf 0773
 Maxent 0762, 1211, 1755,
 1756, 1757
 Maxim 1556, 1982
 MCE 0009
 Meck 0698, 0891
 Mediator 0556, 0037, 0012
 Medion 0556, 0037, 0714,
 0668, 1037, 0698,
 1137, 0512, 0808,
 0880, 1248, 1900
 Megapower 0700
 Megas 0610
 Megatron 0647, 0178, 0145,
 0003, 0009, 0056,
 0151
 MEI 1037, 0185
 Meile 0264, 0412, 0817
 Memorex 0154, 0250, 0463,
 0180, 0150, 0060,
 0178, 0030, 0037,
 0195, 1037, 1926,
 1911, 0877, 0179,
 0165, 0056, 0039,
 0035, 0032, 0016,
 0009
 Memphis 0009
 Mercury 0060, 0037, 0009
 Mermaid 0037
 Metronic 0625
 Metz 0037, 0668, 0195,
 0587, 0367, 0388,
 0447, 0535, 0554,
 0746, 1163, 1533
 MGA 0150, 0178, 0030,
 0218, 0019, 0374
 MGN Tech. 0178
 Micro Genius 0150
 Micromaxx 0037, 0714, 0668,
 1037, 0808

Microstar	0808	Multitech	0180, 0037, 0486, 0264, 0370, 0009, 0179, 0217, 0247	Neufunk.....	0556, 0037, 0714, 0610, 0218, 0009	Oceanic	0548, 0361, 0163, 0208, 0473
MicroTEK	0820, 0860			New Tech	0556, 0037, 0009, 0056, 0217, 0343	Odeon	0264
Midland	0047, 0017, 0051, 0018, 0019, 0032, 0039, 0056, 0135	Murphy	0032, 0039, 0163, 0474	New World	0218	Okano	0037, 0264, 0370, 0009
Mikomi	1037, 1149	Musikland	0218, 0247	Newave	0093, 0178, 0009, 0092, 1150	Olevia	1144, 1240, 1331, 1610
Minato	0556, 0037	Mx Onda.....	1498	Nextier.....	1598	Olidata	1376
Minerva	0195, 0487, 0108, 0070, 0535, 0554	Myryad	0556	Nicam	0544	Omega	0264
Minoka	0037, 0412	NAD	0156, 0178, 0166, 0037, 0361, 0019, 0056, 0866, 1156	Nikkai	0037, 0264, 0218, 0036, 0009, 0032, 0035, 0163, 0179, 0217	Omni.....	0748, 0698, 0780, 0826, 0872, 0891
Mintek	1603	Naiko	0037, 0606, 1982	Nikkei	0714	Onida	0053, 1253
Minutz	0021	Nakimura	0037, 0374	Nikko	0178, 0030, 0092	Onimax	0714
Mirror	1900	Nanbao	0264, 0009, 0412	Nikkodo.....	0178, 0030, 0092	Onking	0280
Mitsubishi.....	0150, 0868, 0154, 0250, 0093, 0236, 0180, 1250, 0178, 0030, 0556, 0037, 0195, 1037, 0036, 0108, 1171, 1150, 1182, 0836, 0817, 1917, 0535, 0512, 0474, 0381, 0179, 0056, 0033, 0019, 0011	Nansheng	0264, 0412, 0817	Nintaus.....	0891	Onwa	0180, 0218, 0433, 0371, 0602
Mivar	0217, 0609	Narita	1982	Nishi	0030, 0018	Opera	0037
Monaco	0009	NAT	0226	Noblex	0154, 0037, 0264, 0018, 0052	Optimus.....	0154, 0250, 0093, 0180, 0150, 0178, 0030, 0166, 0650, 0016, 0032, 0039, 0056, 0165
Monivision	0700, 0843	National	0051, 0226, 0508, 0055, 0208	Noblisko.....	0070	Optoma	0887, 1348
Morgan's	0037	NEC	1398, 0047, 0154, 0156, 0051, 0053, 0178, 0030, 0264, 0036, 0455, 0653, 0508, 0499, 0603, 0661, 0704, 0817, 0882, 1150, 1182, 1378, 1456, 1704, 0497, 0474, 0412, 0381, 0374, 0217, 0186, 0170, 0165, 0056, 0046, 0019, 0016, 0011, 0009	Nogamatic	0109	Optonica.....	0093, 0165
Motorola.....	0054, 0051, 0093, 0150, 0055	Neckermann	0556, 0037, 0370, 0200, 0247, 0327, 0411, 0418, 0554	Nokia	0180, 0548, 0610, 0606, 0361, 0163, 0179, 0208, 0339, 0346, 0374, 0473, 0480, 0492	Orbit	0037
MTC	0180, 0060, 0030, 0370, 0011, 0019, 0032, 0039, 0056, 0092, 0185, 0282, 0512	NEI.....	0037, 0163, 0371	Norcent	0748, 0824, 1089, 1365, 1590	Origo	0003
MTEC	0032	Neovia	0865, 1376, 1964	Nordic	0217	Orion	0443, 0017, 0236, 0463, 0180, 0178, 0556, 0037, 0714, 0264, 1954, 1929, 1916, 1911, 1463, 1196, 0880, 0544, 0474, 0443, 0412, 0355, 0179, 0177, 0019, 0011
MTlogic	0714	Nesco	0179, 0247	Nordmende	0037, 0714, 0560, 0195, 0109, 0287, 0343, 0891	Orline	0037, 0218
Mudan	0051, 0264, 0226, 0009, 0208, 0412, 0817	Netsat	0037	Normerel	0037	Ormond	0668, 1037
Multitec	0037, 0668, 1037, 0486, 1556	NetTV	0762, 1755	Noshi	0018	Osaki	0556, 0037, 0264, 0218, 0032, 0217, 0355, 0374, 0412, 0474
		Network	0032	Novak	0012	Osio.....	0037
				Novatronic.....	0037, 0105, 0374		
				NTC.....	0092		
				Nu-Tec	0698, 0455, 0820		
				Nyon.....	0000		

Quadral	0051, 0218		0165, 0157, 0135, 0092	Saba.....	0250, 0625, 0548, 0714, 0560, 0361, 0109, 0163, 0287, 0335, 0343, 0498	Sanky	0060, 0030, 0019, 0038, 0039, 0280
Qualcraft	0039	Realistic	0047, 0154, 0180, 0150, 0178, 0030, 0003, 0016, 0019, 0032, 0039, 0056, 0165	Sagem	0610, 0455, 0618, 0830	Sansei	0451, 0092
Quartz	0150, 0178, 0046	Recor	0037, 0418	Saige	0009, 0817	Sansui	0463, 0060, 0030, 0706, 0037, 0714, 0455, 1935, 1929, 1911, 1904, 1537, 1531, 0826, 0753, 0729, 0602, 0371, 0165, 0019
Quasar	0250, 0051, 0650, 0009, 0016, 0024, 0035, 0055, 0165, 0247, 0474, 0865, 1919	Rectiligne.....	0037	Saisho	0264, 0009, 0011, 0033, 0163, 0177, 0217, 0544	Santon	0009
Quelle	0037, 0668, 0195, 1037, 0361, 0554, 0544, 0535, 0512, 0327, 0247, 0200, 0109, 0074, 0070, 0032, 0011	Rediffusion.....	0548, 0361, 0036, 0163, 0346	Saivod	0037, 0668, 1037, 0712, 1163, 1556, 1982	Sanyo	0047, 0054, 0154, 0000, 0156, 0463, 0180, 0145, 0171, 0037, 0264, 0370, 0036, 0108, 0508, 0412, 0424, 0474, 0544, 0704, 0798, 0799, 0893, 1755, 1208, 1142, 1150, 1154, 1179, 0381, 0376, 0339, 0280, 0217, 0208, 0170, 0163, 0159, 0157, 0146, 0105, 0088, 0046, 0011, 0009
Questa	0036, 0032	Redstar	0037	Sakai	0163	Sanyong	0037
Questar	0036	Reflex	0037, 0668, 1037	Sakyno	0455	Sanyuan	0093, 0009, 0817
R-Line	0037	Relisys	0865, 0877, 0878, 1211, 1298	Salora	0548, 0361, 0163, 0208, 0480	Saville	0060
Rabbit	0047	Remotec	0250, 0093, 0145, 0171, 0037, 0376, 0424, 0509, 0627	Salsa	0335	SBR	0556, 0037, 0012
Radialva	0218, 0163	Reoc	0714	Salora	0335	Sceptre.....	0878, 1217, 1360, 1599
Radiola	0556, 0037, 0012, 0217	Revox	0037	Sampo	0047, 0154, 0093, 0178, 0030, 0171, 0036, 0650, 1756, 1755, 0762, 0700, 0474, 0092, 0052, 0039, 0032, 0009	Schaub Lorenz .	0548, 0714, 0486, 0606, 0361, 0374
Radiomarelli	0037, 0247	Rex	0264, 0163, 0247, 0411	Samsung.....	1249, 1619, 0060, 0054, 0017, 0154, 0156, 0093, 0047, 0812, 0702, 0178, 0030, 0556, 0037, 0264, 0370, 0036, 0587, 0618, 0226, 1060, 0817, 1150, 0814, 1235, 0774, 0766, 1312, 0718, 1584, 0644, 1630, 1903, 0009, 0019, 0032, 0035, 0039, 0055, 0056, 0090, 0092, 0163, 0179, 0208, 0217, 0362, 0371, 0474, 0519	Schneider	0556, 0037, 0714, 0668, 1037, 0361, 1137, 0218, 1982, 1904, 0648, 0544, 0519, 0394, 0371, 0352, 0343, 0247, 0217, 0163, 0070, 0012
RadioShack.....	0047, 0154, 0180, 0150, 0178, 0030, 0037, 0019, 0032, 0039, 0056, 0165, 1904	RFT	0037, 0264			Scimitsu.....	0019
Radiotone	0037, 0668, 1037, 0264, 0370, 0009, 0412, 0418, 0648	Rhapsody	0185			Scotch	0178
Rank.....	0070	Rinex	0773				
Rank Arena.....	0036, 0602, 0753	Road Authority .	0282				
RBM	0070	Roadstar	0037, 0714, 0668, 1037, 0264, 0218, 0009, 0282, 0418, 1189, 1900				
RCA.....	0047, 0054, 0000, 0051, 0093, 0060, 0178, 0030, 1447, 1454, 0625, 0560, 0618, 2002, 1922, 1919, 1917, 1547, 0018, 0019, 1347, 1247, 1147, 1047, 0774, 0753, 0679, 0021, 0038, 0090,	Rover	0036, 0877				
		Rowa	0748, 0037, 0698, 0712, 0264, 0587, 0009, 0817				
		Royal	0825				
		Royal Lux	0370, 0335, 0412				
		Runco	0017, 0060, 0030, 0016, 0497, 0603, 1398				
		Ruyi.....	0817				
				Samsux	0038, 0039		
				Sandra	0217		
				Sanjian	0264, 0412		

Scotland.....	0163	Sharp	1393, 0818, 0093, 1602, 0054, 0180, 0053, 0030, 0668, 0036, 0650, 0653, 1193, 0688, 0689, 0720, 0787, 0851, 1165, 1917, 0491, 0474, 0386, 0256, 0200, 0179, 0165, 0157, 0039, 0032, 0019, 0009	Silver	0361, 0036, 0455, 0019, 0179	Sonolor.....	0548, 0361, 0163, 0208, 0282
Scott	0236, 0180, 0178, 0030, 0019, 0039, 0177, 0179, 1189	Shen Ying	0003, 0009, 0092, 0179, 0474	SilverCrest	1037	Sontec	0037, 0370, 0009
Sears	0047, 0054, 0017, 0154, 0000, 0156, 0051, 0093, 0060, 0053, 0178, 0030, 0171, 0166, 0037, 0036, 0159, 0165, 0179, 0208, 0280, 1904, 1926, 0146, 0135, 0096, 0056, 0055, 0039, 0038, 0035, 0032, 0024, 0021, 0020, 0019, 0018, 0016	Shencai.....	0145, 0264, 0009, 0412	Simpson.....	0178, 0030, 0011, 0186, 0187	Sony	0000, 0834, 1599, 0017, 0154, 1100, 0150, 0053, 0037, 1505, 0036, 0650, 1925, 1904, 1751, 1685, 1651, 1619, 0011, 1317, 1300, 1167, 0074, 0810, 0080, 0632, 0353, 0157, 0111
Seaway	0634	Sheng Chia.....	0093, 0236, 0009, 0033, 0179, 0474, 1150	Singer	0060, 0037, 0433, 0009, 0092, 0247, 0335, 0371, 0891, 1537	Sound & Vision	0218, 0374
Seelver	1037	Shenyang	0264, 0009, 0696, 0753, 0817	Sinotec.....	0773	Soundesign	0180, 0178, 0019, 0056, 0179, 0186
SEG.....	0037, 0668, 1037, 0487, 0264, 0218, 0036, 0009, 0217, 0247, 0362, 1163	Sherwood.....	0009	Sinudyne.....	0037, 0361, 0163, 0177, 0544	Soundwave	0037, 0032, 0418
SEI.....	0037, 0163, 0177, 0544	Shintoshi	0037	Skantic.....	0163	Sowa	0156, 0051, 0060, 0178, 0036, 0226, 0092, 0474, 1150
Sei-Sinudyne....	0037, 0544	Shivaki.....	0178, 0556, 0037, 0374, 0443	SKY.....	0037, 0282, 0880	Soyea	0773
Seimitsu	0019	Shogun	0019	Sky Brazil.....	0880	Spectra	0009
Seleco	0264, 0163, 0346, 0362, 0371, 0411, 1351	Shorai	0179	Sky-North	0037	Spectravision ...	0156, 0178, 0159, 0179, 0186
Semivox	0236, 0463, 0180	Show	0009, 0418	Skygiant.....	0180	Spectricon.....	0003, 0032
Semp.....	0156, 1356	Siam	0037	Skysonic.....	0696, 0753	Spectroniq.....	1498
Sencora.....	0009	Siarem	0163	Skyworth.....	0748, 0037, 0698, 0264, 0009, 0696, 0753, 0817, 0825	Squareview.....	0171
Sentra	0035	Siemens.....	0145, 0037, 0195, 0032, 0146, 0157, 0200, 0327, 0535, 0554	Sliding.....	0865, 0880	SR2000	0154, 0171
Serie Dorada....	0156, 0180, 0178, 0030, 0019, 0056	Siera	0556, 0037, 0012	SLX	0668	Ssangyong	0009, 0032
Serino	0093, 0610, 0455	Siesta	0370	Smaragd	0487	SSS	0180, 0019
Shancha.....	0264, 0412, 0817	Signature	0047, 0093, 0030, 0016, 0165, 0179, 0187	Solar Drape.....	0000, 0032	Stag.....	0032
Shanghai.....	0264, 0226, 0009, 0208, 0412, 0817	Sierni	0556, 0037, 0012	Solavox	0037, 0548, 0361, 0032, 0163	Staksonic	0009
Shaofeng.....	0145, 0817	Signet	1262	Sole.....	0813	Standard.....	0037, 1037, 0218, 0009, 0217, 0374
		Silva	0037, 0361, 0648	Sonawa	0218	Standard Comps	0218, 0009
		Silva Schneider	0037, 1556	Songba	0009	Starlite.....	0236, 0180, 0037, 0264, 0009, 0019, 0163
		Silvano.....	0587	Soniko	0037	Stenway	0218, 0282
				Soniq	1467	Stern	0264, 0163, 0411
				Sonitron	0370, 0208, 0217, 0339	Stevison	1982
				Sonix	1376		
				Sonneclair.....	0037		
				Sonoko	0037, 0264, 0009, 0217, 0282		

Strato	0037, 0264, 0009	Synco	0000, 0451, 0093, 0060, 0178, 0036, 0092, 0474	Tech Line	0037, 0668, 1163		0754, 0820, 0896, 1556
Strong	1149, 1163	Syntax	1144, 1240, 1331	Tech Lux.....	1189	Telefusión	0037
Studio Experience	0843	Sysline	0037	Technica.....	0218	Telegazi.....	0037, 0264, 0218, 0163
Stylandia	0217	T+A	0447	Technica.....	1982	Telemeister	0037
Sunkai	0610, 0487, 0218, 0455, 0355, 0865	Tacico	0178, 0009, 0092, 0179, 0474, 1150	Technics.....	0054, 0250, 0051, 0556, 0650, 0226, 0046, 0055	Telesonic	0037
Sunstar	0037, 0264, 0009, 0371	Tai Yi	0009, 1150	TechniSat	0556	Telestár	0556, 0037, 0009
Sunwatt	0455	Taishan	0009, 0374, 0817	Technisson	0714, 1289	Teletech	0037, 0668, 1037, 0009, 0247
Sunwood	0037	Talent	0178	Technol Ace	0179	Teleton	0036, 0179, 0186, 0217
Superla	0217	Tandberg.....	0361, 0109, 0367	Technosonic	0556, 0499	Televideon	0163
Superscan	0093, 0864	Tandy	0093, 0218, 0039, 0163, 0165, 0217, 0247	Technotrend	1531	Television	0037
Supersonic	0455, 0009, 0208, 1189	Tashiko	0036, 0650, 0032, 0033, 0092, 0146, 0163, 0170, 0217, 1150	Technovox	0030, 0217	Tempst	0264, 0455, 0009
SuperTech	0556, 0037, 0218, 0009	Tatung	0054, 0154, 0000, 0156, 0051, 0060, 0037, 0036, 0038, 0033, 0055, 0011, 0009, 0003, 0217, 0474, 1150, 1156, 1248, 1254, 1556, 1756	Techview	0847	Tennessee	0037
Supra	0178, 0009, 0039, 0056, 0374	TCC	0826	Techwood	0250, 0051, 0060, 0003, 0055, 0056, 1163	Tensai	0037, 1037, 0218, 0009, 0105, 0217, 0247, 0371, 00374
Supre-Macy	0039, 0046, 0186	TCL	0706, 0698, 0412, 0826, 1537	Tecnimagen.....	0556	Tenson	0009
Supreme.....	0000	TCM.....	0714, 0808, 1289	Teco	0051, 0093, 0178, 0264, 0218, 0036, 0653, 0009, 0092, 0280, 0474	Tera.....	0030, 0092, 0466, 0474
Susumu	0218, 0287, 0335, 0474	Teac	0706, 0154, 0178, 0171, 0037, 0714, 0668, 1909, 1037, 0698, 0712, 0264, 0455, 0418, 0512, 0544, 0412, 0689, 0282, 0217, 0170, 0159, 0146, 1149, 1755, 1904, 0009	Tedelex.....	0698, 0606, 0009, 0208, 0217, 0418, 0891, 1537	Tevion	0556, 0037, 0714, 0668, 1037, 1137, 0648, 0767, 0808, 1248, 1259, 1289, 1298, 1498, 1556
Sutron	0009	Tec	0037, 0009, 0163, 0217, 0247, 0335, 0474	Teiron	0009	Texet	0218, 0009, 0217, 0374
SV2000	0054			Tek.....	0820	Texla	0780
SVA.....	0748, 0587, 0768, 0865, 0870, 0871, 0872			Teknika.....	0054, 0463, 0180, 0150, 0060, 0178, 0016, 0019, 0032, 0039, 0046, 0056, 0092, 0179, 0186	ThemeScene	0887
Svasa	0455			Teleavia	0287, 0343	Thomas	0047, 0178, 0019, 0039, 0056, 1904
Swisstec.....	0880			Telecolor	0017	Thomson	0047, 1447, 0037, 0625, 0560, 0109, 0287, 0335, 0343
Sydney	0217			Telecor	0037, 0218, 0163, 0217, 0394	Thorn	0037, 0361, 0264, 0036, 0035, 0074, 0109, 0163, 0335, 0343, 0499, 0512, 0535
Sylvania.....	1271, 0047, 0054, 0154, 0000, 0051, 0178, 0030, 0171, 0037, 0036, 0381, 1314, 1394, 1904, 1926, 1931, 0187, 0186, 0179, 0159, 0096, 0092, 0056, 0024, 0020			Telefunken.....	0702, 0037, 0625, 0714, 0560, 0486, 0698, 0712, 0587, 0498, 0346, 0343, 0335, 0287, 0109, 0074, 0056, 0753,	Thorn-Ferguson	0335, 0343, 0499

Tiane	0093, 0817	Toyoda	0264, 0009, 0371	0544, 0554, 1163,	Waltham	0037, 0668, 1037,	
Tiny	1269	Toyomenka	0178	0346, 0327, 0247,		0109, 0217, 0418,	
Tiny Digital	0660	Trakton.....	0264, 0217	0217, 0200, 0177,		0443	
TMK	0236, 0180, 0178,	Trans Continens	0037, 0668, 1037,	0170, 0157, 0146,	Wards	0047, 0054, 0017,	
	0056, 0177		0217	0109, 0105, 0074,		0154, 0000, 0156,	
TML.....	1756	TRANS-conts ..	0556, 0865	0070, 0032, 0011,		0051, 0093, 0236,	
TNCi.....	0017	Transonic	0037, 0698, 0712,	0009		0180, 0060, 0178,	
Tobishi.....	0218		0264, 0455, 0587,	Univox		0030, 0166, 0037,	
Tobo	0748, 0264, 0009,		0009, 0418, 0512,	V.....		0195, 0020, 0019,	
	0412		0780	1756		0165, 0179, 0018,	
Tocom	0156	Triad	0556, 0218	V2max		0186, 0187, 0016,	
Tokai	0037, 0668, 1037,	Trical	0157	0865		0866, 1147, 1156,	
	0009, 0163, 0217,	Trident.....	0217	V7 Videoseven .		1347, 0151, 0135,	
	0374	Trio.....	1498	0880, 1217, 1376,		0111, 0096, 0021,	
Tokaido.....	1037	Tristar.....	0264, 0218	1755		0080, 0024, 0056,	
Tokyo	0035	Triumph	0556, 0037, 0177,	Vector Research		0055, 0027, 0033,	
Tomashi.....	0218, 0282		0346	Vestel		0046, 0039, 0038,	
Tongguang	0264, 0412	Truetone	0250, 0051, 0055	0037, 0668, 1037,		0035	
Tongtel	0587, 0780	Tsoschi	0282	0217, 1163	Warumaia	0374, 0661	
Tophouse	0180, 0672	Tuntex	0030, 0009, 0092,	0037, 0508	Watson	0037, 0714, 0668,	
Topline.....	0668, 1037		0474	Videocon.....		1037, 0218, 0009,	
Toshiba.....	1163, 1256, 1508,	TVS.....	0463	Videologic		0163, 0394, 0519,	
	1306, 0156, 1524,	TVTEXT 95	0556	0218, 0217		1376	
	0154, 0093, 0150,	Uher.....	0037, 0486, 0370,	Videomac.....		Watt Radio	0163, 0544
	1265, 0060, 1145,		0019, 0374, 0418,	0009	Waycon	0156	
	0145, 0166, 0195,		0480	Videosat.....		Wega	0037, 0036
	1037, 0264, 0036,	Ultra	0019, 0039, 0092	0247	Wegavox	0009	
	0618, 0650, 0508,	Ultravox	0037, 0163, 0247,	0037	Weipai	0009	
	1325, 1289, 1343,		0374	Videotechnic		Welltech.....	0714
	1356, 1360, 1369,	Unic Line	0037, 0455, 0473	0217, 0374	Weltblick	0217	
	1456, 1556, 1635,	Unitech.....	0039	Videoton.....		Welton	0178, 0019
	1656, 1704, 1918,	United	0037, 0714, 1037,	0163	Weltstar	1037	
	1935, 1936, 0009,		0587, 1916, 1982	0054, 1398	Westinghouse...	0885, 0000, 0451,	
	0011, 0035, 0070,	Universal	0047, 0037, 0714,	Vidikron.....		0003, 0889, 0890,	
	0109, 0217, 0381,		0021, 0027, 0135	0178, 0036, 0019		1092, 1282, 1577	
	0412, 0423, 0509,	Universum	0037, 0668, 0195,	Vidtech.....		Wharfedale	0556, 0037, 0519,
	0644, 0718, 0832,		1037, 0361, 0264,	0797, 0857, 0864,		0860, 0891, 0896,	
	0845, 1150, 1156,		0370, 0036, 0618,	0885, 1330, 1578,		1556	
	1169, 1173		0362, 0411, 0418,	1627, 1640, 1755	White Westinghs	0451, 0236, 0463,	
Tosonic.....	0185		0473, 0474, 0480,	0060, 0046		0037, 1909, 0179,	
Totevision.....	0051, 0039		0492, 0512, 0535,	0037, 0264, 0032,		0186, 0623, 0889	
Towada	0217			0217, 0474	Winco	0412	
				Vizio	Windsor.....	0668, 1037	
				1758, 0864, 0885,			
				1499, 1755, 1756			
				Vortec			
				0037			
				Voxson			
				0178, 0037, 0163,			
				0418			

Windstar 0282
 Windy Sam 0556
 Wintel 0714
 World 0451, 0236, 0463,
 0180
 World-of-Vision 0865, 0877, 0880,
 0890, 1217, 1289,
 1298
 Worldview 0455
 Wyse 1365
 Xenius 0634, 0661
 Xiahua 0698, 0264, 0009,
 0412, 0773, 0817
 Xianghai 0009
 Xiangyang 0264, 0412
 Xiangyu 0009
 Xihu 0264, 0412, 0817
 Xinaghai 0412
 Xingfu 0009
 Xinghai 0264
 XLogic 0698, 0860
 Xoro 1196, 1217
 XR-1000 0154, 0180, 0171,
 0016, 0096, 0179
 Xrypton 0037
 Yamaha 0030, 0650, 0019,
 0769, 0797, 0833,
 0838, 0839, 1576
 Yamishi 0037, 0218, 0455,
 0217, 0282
 Yapshe 0250
 Yingge 0009
 Yokan 0037
 Yoko 0037, 0264, 0370,
 0218, 0009, 0217,
 0247, 0339
 Yonggu 0009
 Yorx 0030, 0218
 Youlanasi 0817
 Yousida 0009

Ytaiwai 1531
 Yuhang 0009
 Zanussi 0264, 0163, 0217
 Zenith 0047, 0017, 0000,
 0093, 0463, 1265,
 0812, 0178, 0030,
 1145, 0145, 0171,
 0037, 1909, 0146,
 0092, 0039, 0016,
 1305, 1904, 1911,
 1929
 Zenor 0339
 ZhuHai 0009, 0374
 Zonda 0698, 0003

CBL

3M 0033
 A-Mark 0144, 0277, 0008,
 0040
 ABC 0237, 0014, 0003,
 0008, 0007, 0011,
 0013, 0017, 0033
 Accuphase 0014, 0003, 0007,
 0011, 0013, 0017
 Acorn 0237
 Action 0237
 Active 0237
 ADB 1082, 1230, 1269,
 1927
 Aichi Denshi 1512
 Aim 0015
 Allegro 0153, 0315
 American 0060
 Americast 0899
 Amstrad 1222
 Archer 0237, 0153, 0797
 Auna 0277, 1230, 1269
 Austar 0276, 0012
 BCC 0276
 Bell & Howell 0014
 Bell South 0899
 Birmingham
 Cable Comms .. 0276
 British Telecom 0003
 Cable & Wireless 1068
 Canal+ 0443
 Century 0008, 0153, 0315
 Citation 0017
 Citizen 0153, 0242, 0315
 Clearmaster 0883
 ClearMax 0883
 Colour Voice 0025, 0031
 Comcor 1522
 Comcrypt 0443
 Comtec 0019
 Comtronics 0040, 0060
 Contec 0019
 Cool Box 0883
 Coolmax 0883
 Curtis Mathes 0015, 0242
 Daeryung 0877, 1877, 0477,
 0277, 0008
 Dalvi 1522
 Digeo 1187
 Digi 0637
 Director 0476
 Dumont 0637
 DX Antenna 1500, 1502
 Eastern 0002, 0418
 Emerson 0014, 0015, 0797
 Encon 0008
 Everquest 0015, 0040
 Fastweb 1630
 Filmnet 0443
 Focus 0400

Force 1798
 Fosgate 0276
 Foxtel 1222
 France Telecom 0817
 Freebox 1482
 Fujitsu 1497
 Funai 0019
 Galaxi 0008
 Garrard 0153
 GC Electronics 0040
 GE 0237, 0144, 0021
 Gehua 0476
 Gemini 0015, 0070, 0242,
 0400, 0797
 General Instr. 0476, 0810, 0014,
 0276, 0003, 0012,
 0011, 0015, 0024
 Getterson 0040
 Gibraltar 0003
 GMI 0015, 0797, 0883
 Golden Channel 1110
 GoldStar 0144, 0040
 Goodmind 0797
 Hamlin 0009, 0273, 0015
 Hitachi 0009, 0014, 0003,
 0008, 0011, 0033
 Houston 0011
 Humax 1813
 Hytek 0007
 Hytex 0007
 Insight 0476, 0810
 Jasco 0015, 0153, 0315
 Jebsee 0014, 0400
 Jerrold 0476, 0810, 0014,
 0276, 0003, 0012,
 0011, 0015, 0024,
 0031
 Kabel Deutschld 1981
 Kabelvision 0003

Kloss 0277
 KNC 0008
 Kuang Yu..... 0024
 Leon..... 0015
 LG 0144, 0040
 Macab 0817
 Macom 0033
 Madritel 1230
 Magnavox 0014, 0797
 Maspro 1510
 Matav 1082
 Melita 0003
 Mellenium 0153
 Memorex..... 0000
 Mitsubishi..... 0003
 MNET 0019, 0443
 Mood..... 1386
 Motorola..... 1376, 0476, 0810,
 1187, 1254, 0014,
 0276, 1106, 0400,
 1540
 MS..... 0015
 Multichoice..... 0019, 0443
 Multitech 0883
 MultiVision..... 0012
 NEC..... 1496
 Nikkai 0153
 Nokia 1569
 Noos..... 0817, 1624
 Nova Vision 0277, 0008
 Novaplex..... 0277, 0008, 0017
 NSC..... 0012, 0070, 0400,
 0637
 NTL 1068, 1060, 0276,
 0003, 0277
 Oak 0019, 0007, 0017
 Ono 1068
 Optimus 0021
 Optus 1060, 0276

Pace 0877, 1877, 0237,
 1068, 1060, 0008,
 1577
 Panama 0107, 0021
 Panasonic 0000, 0144, 0107,
 0008, 0021, 0040,
 0375, 1488
 Panther..... 0637
 Paragon..... 0000, 0525, 0008
 Penney 0000, 0637
 Philips..... 0317, 0817, 0013,
 0025, 0031, 0060,
 0153, 0242, 0290,
 1305
 Pioneer 0877, 1877, 0144,
 0533, 0023, 1021,
 1500
 Popular Mechs . 0400
 Prism 0012, 0013
 Pulsar 0000, 0040
 Pulsar 0040
 PVP Stereo VM. 0003
 Quasar 0000
 R-Line 0040
 RadioShack..... 0015, 0153, 0315,
 0797, 0883
 RCA 1256, 0021, 0060,
 0797
 Realistic 0153
 Recoton..... 0153, 0400
 Regal 0279, 0273, 0276
 Regency 0002
 Rembrandt 0011, 0040, 0070,
 0153
 Runco 0000
 Sagem 0817, 1624
 Salora 0000
 Samsung 0000, 0144, 1060,
 0003, 0023, 0040,
 0070, 1666
 Satbox 0375

Scientific Atlanta 0877, 1877, 0477,
 0237, 0000, 0003,
 0277, 0008, 0012,
 0017, 0021, 0025,
 1510
 Sigma 0019
 Signal 0011, 0015, 0040
 Signature 0011
 SL Marx 0040
 Sony..... 1006, 1460
 Sprucer 0144, 0021
 Starcom 0014, 0003, 0015
 Stargate 0014, 0015, 0040,
 0797
 StarHub..... 0276, 1927
 Starquest 0015
 Storm 0637
 Suena Madritel 1230
 Sumitomo 1500, 1503, 1504
 Supercable..... 0276
 Supermax 0883
 Tadiran 0040
 Tele+1 0443
 Teleavia 0040
 Telenet 1920
 Telepiu..... 0443
 Teletronik..... 1522
 Teleview 0040
 Telewest..... 1068
 Telsey 1630
 Thomson..... 1256, 1110, 1582
 Time Warner cbl 1877
 Timeless..... 0040, 0418
 Tocom 0019, 0012, 0013
 Torx 0003
 Toshiba 0000, 1509
 Trans PX..... 0276, 0153, 0315
 TransACT 1106, 1386
 Tristar 0883

TS..... 0003, 0024
 Tusa..... 0015
 TV Comm 0019
 TV86 0040
 Unika 0153
 United Artists .. 0007, 0024
 United Cable 0014, 0276, 0003,
 0011
 Universal 0153, 0315
 UPC..... 1582
 US Electronics . 0276, 0003, 0008,
 0017
 V2 0883
 Videoway..... 0000
 Viewmaster..... 0883
 Viewstar..... 0060
 Vision 0883
 Visiopass 0817
 Vortex View 0883
 Zenith 0000, 0525, 0899,
 0008, 0015, 0017,
 0060, 0153, 0315
 Zentek 0400

SAT

@sat 1300, 1831
 @Sky 1334
 ABSat 0713
 ADB..... 0642, 0887, 0241,
 1259, 1367, 1418,
 1473, 1491
 Aiwa 1514, 1515
 Akai 0200
 Alba 0455, 0713, 1284,
 1659, 1811
 Allsat 0200, 0364, 1017

Allsonic.....	0369	Axis.....	1111, 0369	CityCom.....	0299, 0607, 0818, 1075, 1176, 1232	DiPro.....	1367, 1543
Alltech.....	0713	B@ytronic.....	1412	Classic.....	1672	DirecTV.....	1377, 0392, 0566, 0639, 1639, 1142, 0247, 0749, 1749, 0724, 0819, 1856, 1076, 1108, 0099, 1109, 1392, 1414, 1442, 1443, 1444, 1609, 1640
Allvision.....	1232, 1334, 1412	Bauckhage.....	1331	Clatronic.....	0332, 1413	Discoverer.....	0605
AlphaStar.....	0772	Beko.....	0455	Clemens Kamphus.....	0396	Dish Network Sys.....	1505, 1005, 0775, 1170, 1775
Amitronica.....	0713	Bell ExpressVu.....	0775	CNS.....	1367	Dishpro.....	1505, 1005, 0775, 1775
Ampere.....	0132, 0396	Bentley Walker.....	1017	Cobra.....	0396	Distratel.....	0885, 1283, 1704
Amstrad.....	0847, 1175, 0132, 0338, 0396, 0713, 0885, 1113, 1693, 1801	Best.....	0369	Colombia.....	0132	DMT.....	1075
Anglo.....	0713	Big Sat.....	1457	Columbia.....	0132	DNT.....	0200, 0396
Ankaro.....	0369, 0713, 1279	Black Diamond.....	1284	Comag.....	0132, 1232, 1366, 1412, 1413, 1579	Dream Multimedia.....	1237
AntSat.....	1017, 1083	Blaupunkt.....	0173	Condor.....	0369, 0607	DSE.....	1375
Apollo.....	0455	Blue Sky.....	0713	Connexions.....	0369, 0396	DSTV.....	0879, 0642, 1433
Arcon.....	0332, 1075, 1279	Blue Star.....	1279	Conrad.....	0132, 0369, 0607	Dune.....	0369
Arcus.....	1143	Boca.....	0132, 0713, 1232, 1366	Coship.....	1457	Durabrand.....	1284
Arion.....	1115	Bose.....	1616	Crossdigital.....	1109	DX Antenna.....	1530
Armstrong.....	0200	Boston.....	1251	Crown.....	1284	Echostar.....	1505, 1005, 0775, 0853, 0167, 0610, 1200, 1775, 1767, 1473, 1418, 1409, 1323, 1170, 0713, 0455, 0396
Arnion.....	1300	Brainwave.....	0332, 0658, 1294, 1672	Cryptovision.....	0455	Einhell.....	0132, 0713
Asat.....	0200	British Sky Bcasting.....	0847, 1175, 1656, 1662	Cyfra+.....	1076	Elap.....	0713, 1129, 1567
ASCI.....	0114, 1334	Broco.....	0713	Cyrus.....	0200	Electron.....	1279
ASLF.....	0713	BskyB.....	0847, 1175, 1662	D-box.....	0723, 1114	Elsat.....	0713
AssCom.....	0853	BT.....	1296	Daeryung.....	0396	Elta.....	0200, 0364, 0369, 1659
AST.....	0321	Bubu Sat.....	0713	Daewoo.....	1111, 0713, 1296, 1743	Emme Esse.....	0369
Aston.....	1129, 1261	Bush.....	1284, 1471, 1645, 1672, 1743, 1811	Deltasat.....	1075	Energy Sistem.....	1631
Astra.....	0607, 0713	Canal.....	0853	Dgtec.....	1242, 1542, 1631	Engel.....	0713, 1017, 1251
Astratec.....	1743	Canal Digital.....	0853, 1622, 1780	Digatron.....	1294	EP Sat.....	0455
Astro.....	0173, 0369, 0607, 0658, 1099, 1100, 1113	Canal Satellite.....	0853, 0292, 1339, 1853	Digenius.....	0299, 1161	Esat.....	0879
Atsat.....	1300, 1831	Canal+.....	0853	Digitality.....	0607	Eurieult.....	0885
AtSky.....	1334	Centrex.....	1457	Digifusion.....	1645, 1743		
Audioline.....	1672	Century.....	0856	DigiLogic.....	1284		
Audioton.....	0364	CGV.....	1413	DigiQuest.....	1300, 1457, 1473		
Aurora.....	0879, 0642, 1433	Chaparral.....	0216	DigiSat.....	1232		
Austar.....	0879, 0642, 0494, 1176, 1259	Chess.....	0114, 0713, 1334, 1626	Digisky.....	1457		
Avalon.....	0396	Chili.....	1718	DigitAll World.....	1227		
Axil.....	1457, 1659			Digiturk.....	1076		
				Digiwave.....	1631		
				Dijam.....	1296		

Eurocrypt 0455
 EuroLine 1251
 Europa 0607
 Europhon 0132, 0299, 0607
 Eurosky 0132, 0114, 0299, 0369, 0607
 Eurostar 0607, 0818
 Eutelsat 0713
 Expressvu 0775, 1775
 Eycos 1279
 Fagor 0364
 Fenner 0369, 0605, 0713
 Ferguson 0711, 0455, 1291, 1743
 Finepass 1593, 1780
 Finlandia 0455
 Finlux 0455
 Flair Mate 0713
 FMD 0114, 1251, 1413, 1457
 Fortec Star 1017, 1083
 Foxtel 0879, 0720, 0455, 1176, 1356
 Fracarro 0125
 Freecom 0335
 Fresat 0885
 FTEmaximal 0369, 0713
 Fuba 0173, 0299, 0369, 0396, 1161, 1214, 1251, 1801
 Fugionkyo 0125
 Funai 1377, 0338
 Galaxis 0853, 1111, 0879, 0364, 0369, 1557
 Galaxisat 0321
 Gardiner 0818
 Garnet 1075
 GbSAT 1214
 GE 0392, 0566

Gecco 1412
 General Instr. ... 0869
 General Satellite 1176
 Globo 1251, 1334, 1412, 1429, 1626
 GOD Digital 0200
 GOI 0775, 1775
 Gold Box 0853, 0292
 Gold Vision 1017, 1631
 Golden Interstar 1283
 GoldStar 0335
 Goodmans 0455, 1246, 1284, 1291
 Gradiente 0856, 0099, 0887
 Granada 0455
 Grothusen 0335
 Grundig 0847, 0853, 0173, 0879, 1291
 Haensel & Gretel 0132
 Handan 1622, 1780
 Hanseatic 0605, 1099, 1100
 Hantor 0332
 Hauppauge 1294, 1672
 HB 1214, 1801
 HDT 1159
 HE@D 1279
 Heliocom 0607
 Helium 0607
 Hills 1232
 Hirschmann 1111, 0173, 0125, 0299, 0369, 0396, 0607, 1232, 1412
 Hisawa 0332
 Hisense 1535
 Hitachi 0749, 0819, 0214, 0455, 0489, 0491, 1250, 1284, 1518, 1523, 1525
 HNE 0132

Homecast 1214, 1680
 Hornet 1300
 Houston 0775, 0396
 HTS 0775, 1775
 Hughes Net Sys 1142, 0749, 1749, 1442, 1443, 1444
 Humax 1176, 1427, 1670, 1675, 1743, 1790, 1882, 1915
 Hung Chang 0732
 Huth 0132, 0332, 0335, 0364, 0607, 1017, 1075, 1143
 Hwalin 0885
 Hyundai 1075, 1159
 iCan 1367
 ID Digital 1176
 IEEC 0605
 ILLUSION sat... 1557, 1631
 iLo 1535
 Imperial 1334, 1429, 1672
 Indovision 0887
 Ingelen 0114, 0396
 Innova 0099
 International 0132
 Interstar 1017, 1214
 Intervision 0364, 0607
 Irradio 1331
 ISkyB 0887
 ITT Nokia 0723, 0455
 Jadeworld 0642
 Jaeger 1334
 Jerrold 0869
 JiWon 0364
 Johansson 0332, 0364
 Jolly 0364
 JSR 0364

JVC 0775, 0492, 1170, 1507, 1531, 1532, 1775
 K-SAT 0713
 Kamm 0713
 Kaon 1300, 1583
 KaTelco 1111
 Kathrein 0173, 0200, 0114, 0480, 0504, 0553, 0658, 0713, 0818, 1416, 1561, 1567, 1706, 1707, 1709
 Kennex 0125
 Kenwood 0853
 Key West 0132
 Kiton 0114
 Konig 0607
 Kosmos 0335
 Kreatel 1385
 Kreiling 0114, 0658
 Kreiselmeier 0173
 L&S Electronic . 0132, 0369, 1334
 Labgear 1296
 LaSAT 0173, 0132, 0299, 0369, 0607
 Lava 1631
 Legend 1718
 Legrand 1718
 Lemon 1334
 Lenco 0335, 0369, 0607, 0713
 Lennox 0369
 Lenoxx 1611
 LG 0335, 1075, 1226, 1414
 Lifesat 0132, 0299, 0369, 0605, 0713
 Lodos 1284
 Logik 1284
 Logix 1017, 1075

Lorenzen	0132, 0299, 0607, 1161, 1294, 1579	Microtec.....	0713	Optex	0114, 0364, 0713, 1283, 1611	Pioneer	1142, 0853, 0292, 0329, 0352, 1308, 1442
Lorraine	0335	Mitsubishi	0749, 0455, 0491	Optimus	0724	Planet	0396
Lupus	0369	Morgan's.....	0200, 0132, 0364, 0713, 1232, 1412	Optus	0879, 1143	PMB	0713, 1611
M Electronic	0818	Motorola	0869, 0856, 1473	Orbis	1232, 1334, 1412	Polytron	0396
M vision.....	1557	MTEC.....	1214	Orbitech	0114, 1099, 1100	Portland.....	1296
M&B	0605	Multibroadcast .	0879, 0642	P/Sat	1232	Power Sky	1279
Magnavox	0724, 0722	Multichoice	0879, 0642, 1433, 1559, 1560	Pace.....	0847, 0853, 0200, 0887, 0720, 1175, 0791, 0455, 0329, 0241, 1323, 1356, 1423, 1623, 1693, 1717, 1848, 1850	Predki	0332
Manata	0132, 0713	Muratto	0321, 0335	Pacific	1284, 1375	Preisner	0132, 0396, 1113, 1366
Manhattan	0332, 0364, 0455, 1017, 1083	Mx Onda.....	1659	Packard Bell.....	1111	Premier.....	0853, 0723, 0292, 1429
Marantz	0200	Myryad	0200	Palcom	0299, 1161, 1331, 1409	Primacom	1111
Maspro	0173, 0713, 1520, 1530	Mysat	0713	Palladium	0396	Primestar	0869
Matsui	0173, 0332, 1284, 1743	MySky	1693, 1848, 1850	Panarex	1159	Promax	0455
Matsushita.....	0214, 0340, 0500	Navex	0332	Panasat	0879, 1433	Proscan	0392, 0566
Max	0607	NEC	0496, 1270, 1519, 1617	Panasonic	0247, 0701, 0847, 0214, 0340, 0455, 0500, 1304, 1404, 1508, 1526, 1527, 1528	Proton	1535
Maximum	1075, 1334	NEOTION.....	1334	Panda	0173, 0455, 0607	QNS.....	1367, 1404
McIntosh	0869	Netgem	1322	Pansat	1159, 1807	Quadral.....	0369
Mediabox	0853, 0292	Netsat	0099, 0887	Patriot	0132	Quali-TV	1955
Mediacom	1206	Neuf TV.....	1322	Paysat	0724	Quelle	0299, 0607
MediaSat	0853, 0292	Neuhaus	0607, 0713	peekTOn.....	1457	Radiola	0200
Medion	0132, 0299, 0369, 0713, 1075, 1161, 1232, 1334, 1412, 1626	Neuling	0132, 1232	Philips	1142, 0749, 1749, 0775, 0724, 0819, 0856, 1076, 0722, 0099, 0847, 0853, 0173, 0200, 1114, 0887, 0292, 0818, 0455, 0133, 1442, 1543, 1672	RadioShack.....	0566, 0775, 0869
Medison	0713	Neusat	0713, 1279, 1331	Phonotrend	1200, 0364, 1017	Radix	0396, 1113, 1317
Mega	0200	Neveling.....	1161	Pilotime	1339	RCA.....	0392, 0566, 1142, 0775, 0855, 0143, 1291, 1392, 1442
Memorex	0724	Nevir	1659	Pino.....	1334	Rebox	1214
Metronic	0132, 0713, 0818, 0885, 1279, 1283, 1334, 1375, 1704	Newton	0396			Redstar.....	0369
Metz	0173	Next Level.....	0869			Regal	1251
MiCO	1811	NextWave	0732, 1017, 1143			RFT.....	0200
Micro	0607, 0713, 1294	Nikko	0723, 0200, 0713			Roadstar.....	0853, 0713
Micro Elektronik	0713	Noda Electronic	0885, 1704			Rollmaster	1413
Micro Technology	0713	Nokia	0853, 0723, 0455, 1023, 1223, 1311, 1723			Rover	0369, 0713
Micromaxx	0299, 0369	Nordmende	0455, 1611			Rownsonic	1567
Microstar	1075	Novis	0332			S-ZWO	1207
		OctalTV.....	1505, 1294			SAB	1251
		Omega	0887			Saba	0820, 0607, 0885
		Opentel.....	1232, 1412				

Sabre	0455	Sharp	0494, 1489, 1513, 1517, 1955	Stream	1848	Telestar	0114, 1099, 1100, 1251, 1334, 1610, 1626
Sagem	0820, 1114, 1253, 1690, 1692	Siemens.....	0173, 0396, 1334, 1429, 1657	Strong	0853, 0820, 0879, 0132, 0125, 0369, 0713, 1159, 1284, 1300, 1409, 1626, 1765	Telesystem	1801
Samsung.....	1377, 1142, 1276, 1108, 1109, 0853, 1017, 1206, 1293, 1442, 1458, 1570, 1609, 1795, 1916	Silva	0299, 0335	Sunny	1300	Teletech.....	0114
Sanyo	0493, 1219	Skantin	0713	Sunny Sound ...	0369	Televés	0132, 0455, 1214, 1300, 1334, 1742
SAT.....	0321	SKR	0713	Sunsat	0713	Televisa.....	0887
Sat Control.....	1300	SKY	0856, 1856, 0099, 0847, 0887, 1175, 0711, 1656, 1662, 1693, 1848, 1850	Sunstar	0642, 0132, 0369	Telewire	0364, 1232
Sat Cruiser	1143	Sky Brazil.....	0856, 0887	Supermax	1143, 1283	Tempo	1143
Sat Partner.....	0332, 0335	SKY Italia.....	0853, 1693, 1848	Supernova	0887	Tensai	0332
Sat Team	0713	Sky XL	1251, 1412	Systec	1334	Tevion	0713, 1409, 1593, 1622, 1672
SAT+	1409	Sky+	1175	Tagra	0364	Thomson	0392, 0566, 0847, 0853, 0820, 1175, 0292, 0711, 0713, 0607, 0455, 0885, 1046, 1291, 1534, 1543, 1662
Satcom	0605, 0607	Skymaster	1200, 0605, 0713, 1075, 1334, 1409, 1567, 1611	Tantec	0455	Thorn	0455
Satec	0713	Targa	1807	Tatung	0455	Tiny.....	1672
Satelco.....	0369, 1232	Tatung	0455	TBoston	1659	Tioko	0132
Satplus.....	1100	TCL	1143	Tec	1227, 1251, 1322	Tivo.....	1142, 1442, 1443, 1444
Satstation.....	1083	Tecatel.....	1200	Tecatel.....	1200	Tokai	0200
Schaub Lorenz.	1214	Techniland.....	0364	TechniSat	0114, 0396, 0455, 1099, 1100, 1195, 1197, 1322	Tonna	0364, 0455, 0713, 1611
Schneider	1206, 1251	Technomate	1283, 1610	Technosonic.....	1672	Topfield.....	1206, 1207, 1208, 1545, 1783, 1824
Schwaiger	1111, 0132, 0504, 0605, 0607, 0732, 0885, 1075, 1083, 1317, 1334, 1412, 1457	Technoson.....	1429	Technotrend.....	1429	Toshiba.....	0749, 1749, 0790, 0819, 0455, 0486, 1285, 1446, 1501, 1516, 1530
SCS.....	0299, 1331	Technowelt.....	0132, 0607	Technoson.....	1672	TPS.....	0820, 1253
Sedea Electro. .	0132, 0125, 1206, 1279, 1283, 1626	Techsant.....	1017	Technosonic.....	1672	Triad	0321, 0335
Seemann.....	0396	Techwood	0114, 1284, 1626	Technotrend.....	1429	Triax	0853, 0200, 0132, 0114, 0396, 0713, 1113, 1227, 1251, 1291, 1296, 1626, 1742
SEG.....	0114, 0332, 0369, 0605, 1075, 1251, 1626	tekComm	1017	Technowelt.....	0132, 0607	Trio	1075
Seleco	0364	Telasat.....	0605, 0607	Techsant.....	1017	TT-micro	1429
Septimo.....	0885, 1375	Tele System Elec.	0396, 1251, 1409, 1611, 1801	Technowelt.....	0132, 0607		
Serd.....	1412	TeleClub.....	1367	Techsan.....	1017		
Serino	0610	Teleka	0396, 0607	Tele System Elec.	0396, 1251, 1409, 1611, 1801		
Servimat.....	1611	Telesat.....	0605, 0607	TeleClub.....	1367		
ServiSat.....	0713, 1251	SR.....	0132	Teleka	0396, 0607		
		Star.....	0887	Telesat.....	0605, 0607		
		Star Choice.....	0869	Telesat.....	0605, 0607		
		Star Trak	0772, 0869	Telesat.....	0605, 0607		
		Starland	0713	Telesat.....	0605, 0607		
		Starlite	0200	Telesat.....	0605, 0607		
		Starring.....	0332	Telesat.....	0605, 0607		

Turnsat 0713
 Twinner 0713, 1611, 1742
 UEC 0879, 1356
 UltimateTV 1392, 1640
 Uniden 0724, 0722, 1521
 Unisat 0200, 0132
 United 1251
 Unitor 0332
 Universum 0173, 0114, 0299,
 0607, 1099, 1251
 US Digital 1535
 USDTV 1535
 Van Hunen 1161
 Variosat 0173
 Vega 0369
 Ventana 0200
 Versatel 1795
 Vestel 0114, 1251
 VH Sat 0299
 Viasat 1682
 Victor 0492
 Vidtech 0321
 ViewSat 1232
 Visionic 0125, 1279, 1283
 VisionNet 1557
 Visiosat 0114, 0713, 1129,
 1413, 1457, 1718,
 1742, 1807
 Viva 0856
 Voom 0869
 VTech 0321, 0818
 Wavelength 1232, 1413
 Wetekom 0605
 Wewa 0455
 Wharfedale 1284
 Winbox 1801
 Winersat 0332
 Wintel 0299, 1161

Wisi 0173, 0132, 0299,
 0321, 0396, 0455,
 0607
 World 0332
 Worldsat 0114, 1214, 1251,
 1543
 XMS 1075
 Xoro 1807
 Xrypton 0369
 Xsat 0847, 0713, 1214,
 1323
 Xtreme 1300
 Yakumo 1413
 Yamada 1718
 Yes 0887
 Zehnder 0114, 0321, 0369,
 0504, 0818, 1075,
 1232, 1251, 1616
 Zenith 0856, 1856
 Zeta Technology 0200
 Zodiac 0396, 1801

CD/DVD

RCA 0522
 Sharp 0037
 Sony 0878, 1033
 Universum 0053

DVD

3D LAB 0503, 0539
 4Kus 1158
 A-Trend 0714
 Accurian 1072, 1416

Acoustic Solutions 0730, 0713, 1228,
 1242, 1316
 Adcom 1094
 Advent 1016
 AEG 0770, 0790, 0788
 AFK 1051, 1152
 Afreedy 0698
 Aim 0672, 0699, 0778,
 0833, 1165, 1177
 Airis 0672, 0826, 1005,
 1107, 1224, 1321,
 1345
 Aiwa 0533, 0641
 Akai 0770, 0695, 0790,
 0690, 0705, 0716,
 0766, 0779, 0788,
 0884, 0898, 0899,
 1089, 1115, 1233
 Akashi 0838
 AKI 1005
 Akira 0699, 1321
 Akura 0898, 1051, 1140,
 1171, 1233, 1367
 Alba 0672, 0539, 0717,
 0695, 0730, 0699,
 0713, 0783, 0884,
 1140, 1530, 1610
 Albatros 1001
 Alco 0790
 Alize 1151
 All-Tel 0835, 1451
 Allegro 0869
 Altacom 1224
 Amisos 0782
 Amitech 0784, 0770, 0850
 Amoi 0852
 Amoisonic 0835
 Amphion Media Works 0872, 1245
 Amstrad 0770, 0713, 1151,
 1173, 1367, 1407

Amuseer 1351
 AMW 0872, 1245
 Ansonic 0831, 0759, 1316,
 1351
 Apex Digital 0533, 0672, 0717,
 0755, 0794, 0796,
 0797, 0830, 1004,
 1020, 1056, 1061,
 1100, 1126
 Aria 0893
 Arianet 0818, 0893
 Aristona 0539, 0646
 Arrgo 1023
 Asono 1224
 Aspire Digital ... 1168, 1407
 Astar 1489
 Atacom 1224
 Audiologic 0736
 Audiosonic 0690, 1265
 Audiovox 0717, 0790, 1041,
 1071, 1072, 1121,
 1122
 Audioworld 0790
 Autovox 0713
 Auvio 0843
 Aviovis 1165
 Awa 0730, 0872
 Axion 0730, 1071, 1072,
 1193
 B & K 0655, 0662
 Bang & Olufsen 1696
 Base 1451
 Basic Line 0713
 Baze 0898, 1165
 BBK 0862, 1224
 Beep 1163
 Bel Canto Design 1571
 Bellagio 1004, 1245
 Belson 1086

Best Buy	1089	Centrum.....	0713, 0779, 0789, 1005, 1227		1117, 1129, 1173, 1502, 1537	digiRED	0717
Black Diamond.	0713, 0766, 0833, 0884	CGV.....	0751, 1115	Cydectin.....	1074	Digital i	0893
Blaupunkt	0717	Changhong	0627, 1061	Cytron	0651, 0705, 0716, 1347	DigitalMax	1738
Blu:sens	1233, 1321, 1489	Cinea	0831, 0841	D-Link	1881	Digitor.....	0651, 0690, 0833, 1005, 1423
Blue Nova Intn .	1321	Cinego	1399	D-Vision	1115, 1367	Digitrex	0672, 1004, 1056, 1100
Blue Parade	0571	Cineral	0730	Daenyx	0872	Digix Media	0826
Blue Sky.....	0672, 0651, 0695, 0790, 0699, 0713, 0778, 0804, 0843, 1423	Cinetec.....	0713, 0872	Daewoo	0490, 0784, 0770, 1483, 1443, 1441, 1436, 1242, 1234, 1172, 1169, 1072, 0872, 0869, 0833, 0714, 0705	DiK	0831
Boghe	1004	cineULTRA	0699			Dinamic	0788
Boman	0783, 0898, 1005	CineVision.....	0876, 0833, 0869, 1483	Dalton	1036, 1107	Disney	0831, 0675, 1270
Bose.....	2023	Citizen	1003, 0695, 1277	Dansai	0770, 0783, 1115	DiViDo	0705
Brainwave	0770, 1115	Clairtone	0571	Dantax	0539, 0790, 0713, 0723, 1089	DK Digital	0831
Brandt	0503, 0651, 0551	Classic.....	0730, 1730	Daytek	0872, 1005	DMTech	0783, 1072
Broksonic	0695, 0868, 1419	Clatronic	0672, 0675, 0788, 0818, 1165, 1177, 1233	Dayton.....	0872	Dragon	0831
Buffalo.....	1882	Clayton.....	0713	DCE.....	0831	DreamX	1151
Bush.....	0672, 0717, 0730, 0831, 1483, 1436, 1419, 1351, 1177, 1165, 1140, 1128, 1051, 0884, 0879, 0833, 0778, 0758, 0723, 0713, 0699, 0690, 0516	Coby.....	0730, 0778, 0852, 1077, 1086, 1107, 1165, 1177, 1321, 1351	Decca	0778, 0818	DSE	0833, 1152, 1483, 1730
Byd:sign	0872	Codex	1233	Denon	0490, 0634, 1282, 1634	DTS	0799
C-Tech	0798, 1152	Commax	1321	Denver	0672, 0699, 0778, 0788, 0898, 1056, 1104, 1107, 1165, 1177, 1265, 1316, 1321	Dual.....	0651, 0730, 0831, 0790, 0665, 0675, 0713, 0779, 0783, 1023, 1068, 1085, 1436
Calif Aud Labs..	0490	Compacts.....	0826, 1107, 1265				
Cambridge Aud	0751, 1109, 1589	Conia	0672, 0516, 0835, 0852, 1321	Denzel	0665	Durabrand	1003, 0831, 0713, 1023, 1127, 1502
Cambge Sndwks	0690	Contel	0788	Desay	0800, 0843, 1407, 1455	DVD2000	0521
Campomatic Dig.	1051	Continental Ed.	0831, 0872	Dgtec	0672	DVX	0768
Cary Audio Des	1477	Craig	0831	Diamond	0651, 0768, 0790, 0751, 0778	E:max	1233, 1321
Cat	0699, 0789, 1421	Creative	0503, 0539	Diamond Vision	1316, 1609, 1610	EagleTec.....	0714
CAVS.....	1057	CrossWood	1446	Dick Smith Elec	0833, 1152, 1483, 1730	eBench	1152
CCE.....	0730	Crown	0770, 0690, 0713, 0769, 1115	Digihome.....	0713	ECC.....	0730
Celestial	1020	Crypto	1228	DigiLogic	0713	Eclipse.....	0723, 0751
cello	1730	Curtis Mathes ...	1087			Electrohome.....	1003, 0893
Centrex	0672, 1004	Cybercom.....	0831			Elfunk	0713, 0850, 0884
Centrios.....	1577	CyberHome	0714, 0816, 0874, 1017, 1023, 1024,			Elin	0770

	1115, 1151, 1173, 1233	GoldStar	0591, 0741, 0801, 0869	Hoehner	0651, 0831, 0713, 0826, 1004, 1224	Kansas Tech.	1233, 1530
Eltax	0766, 1233, 1321	Goodmans.....	0651, 0730, 0790, 0690, 0713, 0723, 0783, 0833, 0879, 1004, 1140, 1177, 1316, 1423, 1530, 1730	Home Elec.	0770, 0730	Karcher.....	0783
Emerson.....	0591, 0675, 0705, 0821, 1268			Home Tech Indus.	1107, 1224	Kawasaki.....	0790
Encore	0698	GP Audio	1140	Hoyo	0665	Kendo	0672, 0831, 0699, 0713
ENTERprise.....	0591	GPX	0741, 0699, 0769	Humax	0646, 1588	Kennex	0770, 0713, 0898
Entivo	0503, 0539	Gradiente	0490, 0651	Hyundai.....	0766, 0783, 0850, 1061, 1228	Kenwood.....	0490, 0534, 0682, 0737, 1063
Enzer	0784, 0770, 0766, 1228	Graetz	0665	I-O Data	1405	Kiiri	0770
ESA	0821, 1268, 1443	Gran Prix	0831, 0898	iLo	1348, 1472	King DHome.....	0799
EuroLine.....	0675, 0788, 1115, 1233, 1351	Grandin.....	0713, 0716, 1173, 1233	Ingelen	0788	Kingavon	0818
Fenner	0651	Greenhill	0717	Ingersol	1023	Kiss.....	0665, 0841, 1523
Ferguson	0651, 0695, 0713, 0884, 0898, 1730	Grundig.....	0539, 0651, 0551, 0695, 0790, 0670, 0705, 0713, 0775, 1004, 1036, 1128, 1177, 1436, 1730	Initial.....	0839, 0717, 1472	KLH	0815, 0717, 0790, 1020, 1149, 1261
Finlux	0672, 0591, 0741, 0770, 0751, 0783, 1165			Inno Hit	0713	Kloss	0533
Fintec	1169	Grunkel	0770, 0831, 0790, 1316	Innovative Tech.	1542	Koda.....	1230
Firstline	0651, 0713, 0799, 0843, 0869, 1530	GVG.....	1169	Insignia.....	1013, 1268	Konka	0711, 0719, 0720, 0721
Fisher	0670	H & B	0713, 0818, 0841, 0850, 1233, 1421	Integra.....	0571, 0627, 1634	Konka	0711, 0719, 0720, 0721
Funai	0695, 0675, 1268, 1334	Haaz	0751, 1152	Irradio.....	0869, 1115, 1224, 1233	Koss	0651, 0769, 0896, 1061, 1423
Fusion	0862	Haier	0843	IRT.....	0783, 1489	Kreisen	1421
Gateway.....	1073, 1077, 1158, 1194	Hanseatic	0741, 0790, 0783	ISP	0695	KXD	0857, 1321
GE	0522, 0815, 0717	Harman/Kardon	0582, 0702	Jamo	1036	Landel	0826
General Electric	0717	HCM	0788	Jaton	0665, 1078	Lasonic.....	0627, 0798, 0789, 1173
Germatic	1051	HDT	0705	Jay-tech.....	1265	Lawson	0768, 0716
Global Link.....	1224	HE.....	0730, 1163	JBL.....	0702	Lecson	1533
Global Solutions	0768	Helios	2080	JDB	0730	Leiker	0872
Global Sphere ..	1152	Henss	0713	JDV	1367	Lenco	0651, 0770, 0699, 0713, 0778, 1165, 1177
Go Video	0573, 0744, 0717, 0741, 1730, 1483, 1443, 1304, 1158, 1144, 1099, 1075, 1044, 0869, 0833, 0783, 0715	Himage	1089	Jeken	0699	Lenoir	1228
Go Vision	1071, 1072	HiMAX	0843	Jensen	1016	Lenoxx	0690, 0838, 1127
		Hitachi	0573, 0664, 0695, 0665, 0713, 0857, 1247, 1664	Jeutech	0766	Lexia	0768, 0699
		Hiteker	0672	JMB.....	0695	LG.....	0591, 0741, 0790, 0801, 0869, 1526
				JNC.....	0672	Lifetec.....	0651, 0831, 1347
				JSI.....	1423	Limit	0768, 0716, 1104
				JVC	0503, 0539, 0558, 0623, 0867, 1164, 1241, 1275, 1597, 1602	LiteOn	1058, 1158, 1416, 1440, 1656, 1738
				jWin	1049, 1051		
				Kansai	1107		

Lodos	0713	0783, 0879, 1006, 1107, 1165, 1270, 1345, 1347, 1423	Neufunk	0665	Packard Bell	0831
Loewe	0539, 0741, 0511, 0885		NeuNeo	0509, 1454	Palladium	0695, 0713, 0779
Logik	0713, 0884	MEI	Nevir	0770, 0831, 1197	Palsonic.....	0672, 0835, 0852, 1056, 1321
Logix	0705, 0783	Memorex	Next Base	0826	Panasonic	0503, 0490, 0571, 0632, 0703, 1010, 1011, 1282, 1362, 1462, 1490, 1579, 1762, 1641
Luker	1367	Metronic	NexxTech	1402	Panda	0717, 0789
Lumatron.....	0741, 0695, 0705, 0713, 0833, 1115, 1321	Metz.....	NFREN	0826	Paramount Picts	0779
Lunatron.....	0741	MiCO	Nikenny.....	1089	peeKTON	0898, 1224
Luxman	0573	Micromedia.....	Nintaus.....	1051	Philco	0790, 0690, 0788, 0862
Luxor	0713, 1004, 1730	Micromega	Norcent.....	1003, 0719, 0872, 1107, 1265, 1457	Philips.....	0503, 0539, 0646, 0675, 0854, 0885, 1158, 1260, 1267, 1340, 1354, 1506, 1755, 2056
Magnasonic	0651, 0675, 0769	Microsoft	Nordmende	0831, 1316	Philo	1345
Magnavox	0503, 0539, 0646, 0675, 0713, 0821, 0885, 1140, 1177, 1268, 1472, 1506	Microstar	Noriko	0752	Phonotrend	0699, 1165, 1177
Magnex	0723, 1165, 1489	Minato	Nowa.....	0843	PianoDisc	1024
Magnum	1436	Minax	Nu-Tec	0516, 1228	Pioneer	0490, 0525, 0571, 0142, 0631, 0632, 0638, 1460, 1531, 1571, 1900
Majestic.....	1107, 1345	Minerva.....	Okano	0752	Playgo	1265
Malata	0782, 1159	Minoka	Olidata	0672	Plu2	0850
Manhattan	0705, 0713	Minowa	Omni	0690, 0698, 0778, 0782, 0833, 0838, 0862, 1104	Pointer.....	0784
Marantz.....	0503, 0539, 0675, 1627	Mintek	Onix	0838	Polaroid.....	1020, 1061, 1086, 1245, 1316, 1478, 1480, 1482
Mark.....	0713	Mirror	Onkyo	0503, 0627, 0792, 1417, 1418, 1612, 1627	Polk Audio.....	0539
Marquant.....	0770	Mitsubishi.....	Oopla	1158	Portland.....	0770
Matsui	0672, 0651, 0695, 0713, 0884, 1004, 1316, 1730	Mizuda	Oppo.....	1224, 1525	Powerpoint.....	0758, 0872, 1005
Maxdorf.....	0788	Momitsu	Optim	0843	Presidian	0675, 1072, 1738
Maxent	1347	Monyka	Optimus	0525, 0571	Prima	0766, 1016, 1228
Maxim	0713, 0872, 1242, 1367	MPX.....	OptoMedia Elec.	0896	Prima Elec	0766
Maya	1345	MTlogic.....	Orava	0818	Primare.....	1467
MBO.....	0730, 0690, 1730	Mustek	Orbit	0872	Princeton	0674
McIntosh.....	1533, 1273	Mx Onda.....	Orion	0695, 1128, 1233, 1419	Prinz	0831
MDS.....	0713, 0778	Myryad	Oritron.....	0651		
Mecotek.....	0770	Mysral.....	Ormond	0713		
Medion	0651, 0630, 0831, 0652, 0716, 0758,	NAD	Otic	0826, 1455		
		Naiko	P&B.....	0818, 1451		
		Nakamichi	Pacific	0695, 0831, 0768, 0790, 0713, 0759, 0804		
		Narita				
		NEC				
		Nesa				

Prism	0831, 0705, 1089	1051, 1177, 1227, 1446	SEG.....	0798, 0665, 0713, 0763, 0872, 0884, 1173, 1483, 1530	Sony	0533, 1533, 0864, 0573, 0630, 1017, 1033, 1069, 1070, 1431, 1432, 1433, 1516, 1536, 1548, 1633	
Pro2.....	1107, 1345	Rocksonic	0789	Semp.....	0503	Sound Color	1233
ProCaster	1004	Ronin	0710, 0872	Sensory Science	1158	Sound Mobile...	1298
Proceed	0672	Rotel	0558, 0623, 1178	Shanghai.....	0672	Soundmaster....	0768
Proline	0672, 0651, 0710, 0833, 1004, 1068, 1483	Rowa	0717, 0516, 0759, 0823, 0872, 1004	Sharp	0630, 0675, 0713, 0752, 1256, 1419, 1642	Soundmax	0768
Proscan	0522	Rownsonic	0789	Sharper Image .	1117	Soundwave	0783
Proson	0713	S&V.....	1165	Sherwood.....	0717, 0741, 0770, 0633, 1043, 1077	Sova	1122
Prosonic	0699, 0752, 1169, 1441	Saba	0651, 0551, 0769	Shinco	0717, 1472	Spectra.....	0872
ProVision	0730, 0699, 0778, 1107, 1163, 1321	Sabaki	0798	Shinsonic	0533, 0839	Standard.....	0651, 0831, 0768, 0788, 0898
Pye	0539, 0646	Saivod	0831, 0759, 1367	Siemssen	1382	Star Clusters.....	1152, 1227
QONIX	1051, 1177	Salora	0741, 1446	Sigma Designs.	0674	Starlogic	1005
Qwestar.....	0651	Sampo	0698, 0752, 1321, 1347, 1501	Sigmatek.....	1005, 1224	Starmedia	0818, 1005, 1224
Radionette.....	0741, 0869	Samsung	0490, 0573, 0744, 0199, 0820, 0899, 1044, 1075, 1635	Siltex	1224	Stevision.....	1367
RadioShack.....	0571	Sansui	0784, 0695, 0768, 0716, 0751, 0763, 1051, 1228, 1230, 1316	Silva	0788, 0898	Strong	0713
Raite	0665	Santosh	1115	Silva Schneider	0831, 0898	Sungale	1074, 1532
RCA.....	0522, 0571, 0717, 0790, 0769, 0822, 1013, 1022, 1132, 1193, 1769	Sanyo	0695, 0670, 0675, 0713, 0873, 1228, 1334	SilverCrest.....	1152	Sunkai	0770, 0850
Realistic	0571	Scan	0705, 0835, 0850	Simaudio.....	0885	Sunstech	0831, 1072
REALmagic	0674	ScanMagic	0730, 1730	Singer	0768, 0690, 0716, 0751	Sunwood	0788, 0898
REC	0490, 0766	Schaub Lorenz .	0770, 0788, 1115, 1151, 1165	Sinudyne	1316	Superscan	0821
Recco	0698	Schneider	0539, 0646, 0651, 0831, 0790, 0705, 0713, 0779, 0783, 0788, 0804, 0869, 1367	Sistemas	0672	Supervision.....	0768, 1152
Redstar.....	1003, 0770, 0759, 0763, 0788, 0898, 1107, 1345	Schwaiiger	0752	Skantic	0539, 1003, 0713	Supratech	0893
Relisys.....	1347	Scientific Labs .	0768	Skymaster	0730, 0768	SVA.....	0672, 0717, 0752, 0860, 1105
Reoc.....	0768, 0752	Scott	0672, 0651, 1005, 1036, 1233, 1423	Skysonic	0766	Sylvania.....	0630, 0675, 0821, 1268
Revoy	0699, 0841	Seeltech.....	1224, 1451	Skyworth.....	0766, 0898	Symphonic	0675, 0821, 1268, 1334
Rex	0838			Sliding	1115	Synn	0768
Richmond.....	1233			Slim Art	0784	TAG McLaren....	0894
Rio	0869			SM Electronic...	0730, 0768, 0690, 1152	Tandberg	0713
RJTech	1360			Smart	0705, 0713	Tangent.....	1321
Roadstar.....	0672, 0730, 0690, 0699, 0713, 0818, 0833, 0879, 0898,			Sonai	0755	Targa	1227
				Sonashi	0831, 0716	Tatung	0770
				Sonic Blue.....	0573, 0715, 0783, 0869, 1099	Tchibo	0741

TCM 0741, 0790
 Teac..... 0571, 0717, 0741,
 0768, 0790, 1483,
 1227, 1197, 1165,
 1006, 0833, 0809,
 0759, 0758, 0692,
 0675, 0516
 Tec..... 0898
 Technica..... 1367
 Technics 0490, 0703
 Technika..... 0770, 0831, 1115,
 1165, 1489
 Technissson 1115
 Technosonic..... 0730, 1051, 1115
 Techwood..... 0692, 0713, 1530
 Tedex..... 0768, 0690, 1004,
 1228
 Telefunken..... 0790, 0758, 0789,
 0833, 1483
 Teletech..... 0768, 0713
 Tensai 0651, 0770, 0690
 Terapin 1031
 Tevion 0651, 0798, 0768,
 0652, 0833, 0898,
 1036, 1227, 1347,
 1382, 1483, 1730
 Theta Digital 0571
 Thomson 0522, 0551, 0511
 Tiny 1489
 Tivo 1503, 1588
 Tokai 0784, 0790, 0665,
 0698, 0788, 0898
 Tokaido..... 0698
 Tokiwa 0716
 Tom-Tec 0789
 Top Suxess 1224
 Toshiba..... 0503, 0573, 0539,
 0695, 1045, 1154,
 1503, 1510, 1588,
 1769
 Trans Continens 0826

TRANS-contrs .. 0831, 0826, 0872,
 1165, 1321, 1327
 Transonic 0730, 1165
 Tredex 0799, 0800, 0803,
 0804, 0843
 TruVision 0857, 1451
 TSM..... 1224
 TYT..... 0705
 Umax 0690, 1151
 Unimax 0770
 United 0695, 0730, 1489,
 1446, 1367, 1351,
 1228, 1173, 1165,
 1152, 1115, 1072,
 0884, 0826, 0788,
 0713, 0699, 0675
 Universum 0591, 0741, 0790,
 0713, 0779, 0869,
 1227, 1530
 Uptek 0763
 upXus 1345
 Urban Concepts 0503, 0539
 US Logic..... 0839
 V 1064, 1126, 1226
 Valor 1298
 Venturer 0790
 Vestel 0713, 0884, 1530
 Vialta 1509
 Victor 1241, 1597
 Vieta 0705, 1265
 Viewmaster..... 0862, 1224
 Vizio 1064, 1126, 1226
 Vocopro 1027, 1360
 Voxson 0730, 0831, 0690
 Vtrek 1228
 Waitec 1151, 1224, 1233
 Walkvision 0717
 Waltham 1530
 Welkin 0831
 Wellington..... 0713

Weltstar..... 0713
 Wesder 0699
 Wharfedale..... 0790, 0698, 0751,
 0752
 Wilson 0831, 1233
 Windsor..... 0713
 Windy Sam 0573
 WIZE 1115
 Woxter 1005, 1151, 1224
 Xbox..... 0522, 1708, 2083
 Xenius 0790
 XLogic 0768, 1152, 1228
 XMS 0770, 0788
 Xoro 1173, 1183
 Xwave 1001
 Yakumo 0652, 1004, 1056
 Yamada 0652, 0872, 1004,
 1056, 1151, 1158,
 1416, 1489
 Yamaha 0490, 0539, 0646,
 0545, 1282, 1354
 Yamakawa 0665, 0710, 0872,
 1104, 1489
 Yukai 0730, 1730
 Zenith 0503, 0591, 0741,
 0869
 Zennox 1265
 Zeus..... 0784
 Zoece 1265

VCR

A-Mark 0037, 0240, 0000,
 0278, 0046
 ABS..... 1972
 Accent 0072

Admiral 0060, 0048, 0039,
 0047, 0104, 0121,
 0209, 0020, 0062,
 0065, 0479
 Adventura 0037, 0240, 0000
 Adyson 0072
 Aiko 0278
 Aim 0278, 0348, 0642,
 0020
 Aiwa 0037, 0032, 0000,
 0209, 0041, 0348,
 0307, 0352, 0124,
 0479, 0742, 1137,
 1284, 1291, 1332,
 1336
 Akai 0037, 0240, 0041,
 0348, 0642, 0352,
 0315, 0020, 0053,
 0061, 0175, 0242
 Akiba 0072
 Akitan 0295
 Akura 0041, 0072, 0271
 Alba 0081, 0000, 0209,
 0072, 0278, 0348,
 0352, 0315, 0020,
 0295
 Alienware 1972
 Allegro 0039, 1137
 Allorgan 0240
 Allstar 0081
 Ambassador..... 0020
 America Action 0278
 American High.. 0035, 0081
 Amoisonic 0479
 Amstrad..... 0000, 0072, 0278
 Anam 0162, 0037, 0240,
 0278, 0579, 1037
 Anam National.. 0162, 1562, 0454,
 0579, 1162
 Anitech 0072
 Ansonic 0000

Arion	1787	Broksonic	0184, 0121, 0209, 0002, 0348, 0208, 0211, 0295, 0361, 0479, 1479, 1815	Crosley.....	0035, 0081, 0000, 0149, 0110	Dual.....	0081, 0000, 0041, 0278, 0348
Aristona.....	0081	Bush	0081, 0000, 0209, 0072, 0278, 0348, 0642, 0352, 0315, 0742	Crown	0037, 0072, 0278, 0020, 0271	Dumont	0081, 0000, 0104, 0105
ASA.....	0037, 0081	Calix	0037	Curtis Mathes ..	0060, 0035, 0162, 0240, 0000, 0041, 0278, 0432, 0277, 0454, 0643, 0760, 1035	Durabrand	0039, 0038, 0642, 0593
Asha.....	0240	Candle	0037, 0038	Cybernex	0240, 0051	Dynatech	0240, 0000
Astra	0035, 0240, 0051	Canon	0035, 0034	CyberPower.....	1972	Elbe	0278, 0038
Asuka	0037, 0081, 0000, 0072, 0038	Capehart.....	0002, 0020, 0062	Cyrus	0081	Elcatech	0072
Audio-Technica	0058	Carena	0081, 0209	Daewoo	0037, 0045, 0104, 0209, 0278, 0642, 0352, 0020, 0046, 0210, 0212, 0368, 0561, 0844, 1137, 1278	Electrohome.....	0060, 0037, 0240, 0000, 0043, 0209, 0061
Audiolab.....	0081	Carrefour	0045	Dansai	0072, 0278	Electroponic ...	0037
Audiosonic	0278	Carrera.....	0240	Dantax	0352	Elin	0240, 0051
Audioton.....	0020	Carver	0035, 0081	Daytron	0037, 0278, 0020	Elsay	0072
Audiovox	0037, 0278, 0038, 0054	Casio	0000	De Graaf.....	0048, 0081, 0042, 0104, 0046	Elta	0072, 0278
AVA Tech.	0615	Cathay	0278	Decca	0081, 0000, 0067, 0209, 0041, 0352, 0008	Emerald	0184, 0121, 0211
Avis	0000, 0072	Catron	0020	Degraff	0048, 0081, 0042, 0104	Emerex	0032
AVP	0000, 0352	CCE	0072, 0278	Deitron	0278	Emerson	0035, 0037, 0184, 0039, 0240, 0045, 0000, 0121, 0043, 0209, 0072, 0002, 0278, 0348, 0561, 0510, 0593, 0479, 0378, 1278, 1479, 0361, 1593, 0343, 0295, 0294, 0212, 0211, 0208, 0202, 0088, 0068, 0061, 0036
Awa	0037, 0043, 0278, 0642, 0075, 0579	Centrum.....	0593	Dell.....	1972	ESA	1137
Baird	0000, 0104, 0041, 0278, 0046	CGE.....	0000, 0041	Denko	0072	ESC	0240, 0278, 0020
Basic Line	0104, 0072, 0278, 0020, 0046	Changhong	0048, 0081	Denon	0081, 0042	EuroLine	1593
Beaumarck.....	0240	Cimline	0209, 0072	Derwent	0041	Europhon.....	0020
Beko.....	0104	Cineral	0278	Diamant	0037	Fenner	0020
Bell & Howell....	0035, 0048, 0039, 0000, 0104, 0046, 0479	CineVision.....	1137	Diamond	0348	Ferguson	0000, 0041, 0278, 0348, 0320, 0053
Bestar	0278, 0020	Citizen	0035, 0037, 0240, 0000, 0209, 0278, 0036, 0479, 1278	Dick Smith Elec	0642, 0579	Fidelity.....	0240, 0000, 0072, 0352, 0432
Black Diamond.	0642	Classic.....	0037	Digitor	0642, 0579	Finlandia	0037, 0048, 0081, 0000, 0042, 0104,
Black Panther...	0278	Clatronic	0000, 0072, 0020, 1593	DiracTV	0739, 2033		
Blaupunkt	0162, 0081, 0034, 0227, 0513	Colortyme	0060, 0035, 0045, 0278	Domland	0209		
Blue Sky.....	0037, 0209, 0072, 0278, 0348, 0642, 0352, 0742, 1137	Combitech	0352	DSE.....	0642, 0579		
Bondstec.....	0072, 0020	Condor	0278, 0020				
BPL	0046	Craig	0037, 0047, 0240, 0072, 0271				
Brandt	0041, 0320	Criterion	0000, 0072				
Brandt Elec.	0041						
Brinkmann	0209, 0348						

	0043, 0384, 0046, 0110	GoldStar	0035, 0037, 0039, 0000, 0209, 0278, 0038, 0018, 0054, 0225, 1137, 1237	Hischito	0045	JMB	0209, 0348, 0352, 0742
Finlux	0081, 0000, 0042, 0104, 0105			Hitachi	0035, 0037, 0081, 0240, 0045, 0000, 0042, 0041, 0384, 1326, 1286, 1037, 0593, 0544, 0105, 0089, 0082, 0065, 0046	Joyce	0000
Firstline	0037, 0045, 0042, 0043, 0209, 0072, 0278, 0348, 0088, 1137	Goodmans	0037, 0081, 0240, 0000, 0209, 0072, 0278, 0348, 0642, 0352, 0020, 0062, 0343, 0579, 0742			JVC	0184, 0081, 0045, 0067, 0041, 0384, 1707, 1329, 1299, 1283, 1279, 1162, 0486, 0366, 0207, 0061, 0058, 0008
Fisher	0039, 0047, 0000, 0104, 0020, 0046, 0054, 0066	GPX	0037	Hoehner	0278, 0642	Kaisui	0072
Flint	0209, 0348	Gradiente	0000, 0008, 1137	Hornophon	0081	Kambrook	0037
Frontech	0072, 0020	Graetz	0240, 0104, 0041	Howard Comps	1972	Karcher	0081, 0278, 0642
Fuji	0035, 0033	Granada	0035, 0037, 0048, 0081, 0240, 0000, 0042, 0104, 0011, 0046	HP	1972	Kathrein	1802, 1868, 1869, 1870
Fujitsu	0037, 0045, 0000, 0366			Hughes Net Sys	0042, 0739	KEC	0037, 0278
Fujitsu General	0037	Grandin	0037, 0000, 0209, 0072, 0278, 0020, 0742	Humax	0739, 1711, 1845, 1853	Keen	0693
Funai	0037, 0000, 0072, 0278, 0294, 0593, 1333, 1593	Grundig	0081, 0072, 0348, 0320, 0352, 0034, 0207, 0347, 0378, 0742	Hush	1972	Kendo	0037, 0209, 0072, 0278, 0348, 0642, 0315, 0053
Galaxi	0000			Hypson	0037, 0000, 0209, 0072, 0278, 0352	Kenwood	0067, 0041, 0038, 0384, 0046
Galaxis	0278	Haaz	0348	Hytek	0047, 0000, 0072, 0036	KIC	0000
Garrard	0000	Hanimex	0352, 0295	iBUYPOWER	1972	Kimari	0047
Gateway	1972	Hanseatic	0037, 0081, 0209, 0038	Imperial	0000	Kioto	0348
GBC	0020	Hantor	0020	Ingersol	0240, 0209	KLH	0072
GE	0060, 0035, 0048, 0240, 0000, 0149, 0320, 0065, 0077, 0202, 0277, 0760, 0761, 0807, 1035, 1060	Haojie	0240	Inno Hit	0072, 0020	Kneissel	0037, 0209, 0278, 0348, 0352
GEC	0081	Harley Davidson	0000	Interbuy	0037, 0072	Kodak	0035, 0037
Gemini	0060	Harman/Kardon	0081, 0038, 0075	Interfunk	0081, 0104	Kolin	0043, 0041
General	0045, 0020, 0366	Harvard	0072, 0068	Internal	0278	Kolster	0209
General Technic	0348	Harwood	0072, 0068	International	0037, 0278, 0642	Korpel	0072
Genexxa	0037, 0000, 0104, 0278	HCM	0072	Intervision	0037, 0000, 0209, 0278, 0348	KTV	0000
Go Video	0240, 0432, 0232, 0526, 0614, 0643, 1137	Headquarter	0046	Irradio	0037, 0081, 0072, 1137	Kuba	0047
GoldHand	0072	Hewlett Packard	1972	ITT	0240, 0104, 0041, 0384, 0046, 0378	Kuba Electronic	0047
		HI-Q	0035, 0047, 0000	ITT Nokia	0240, 0104, 0041	Kyoto	0072
		Hinari	0240, 0209, 0041, 0072, 0278, 0352, 0088, 0208, 0343	ITV	0037, 0278, 0020	Lenco	0278
		Hisawa	0209, 0352	Janeil	0240	Leyco	0072
				JBL	0278	LG	0037, 0240, 0045, 0000, 0042, 0209, 0278, 0038, 0051,
				Jensen	0067, 0041		

	0053, 0225, 1037, 1137, 1237	Master's.....	0278		0642, 1343, 0807, 0443, 0242, 0214, 0173, 0075, 0061	Nu-Tec	0209
Lifetec	0209, 0348	Matsui	0037, 0240, 0209, 0278, 0348, 0352, 0036, 0088, 0208, 0295, 0742	Motorola.....	0035, 0048	Oceanic.....	0048, 0081, 0000, 0104, 0041, 0046
Linksys	1972			Movie Walker ...	0072	Okano	0209, 0072, 0278, 0348, 0315
Lloyd's	0240, 0000, 0072, 0038, 0036, 0208	Matsushita.....	0035, 0162, 0081, 0227, 0367, 0454, 1162	MTC	0240, 0000, 0072	Olympus.....	0035, 0162, 0104
Loewe	1062, 0162, 0037, 0081, 1562, 0105, 0454, 1262	Media Center PC	1972	MTX	0000	Onimax	0642
Logik	0240, 0000, 0209, 0072, 0011	Mediator	0081	Multitec.....	0037	Onkyo	0222
Luker	0579	Medion	0209, 0348, 0642, 0352	Multitech	0039, 0000, 0072, 0020	Optimus.....	1062, 0035, 0162, 0037, 0048, 0047, 0240, 0000, 0104, 0432, 0062, 0058, 0054, 0454, 0593, 1048, 1162, 1262
Lumatron.....	0278, 0593, 1137	MEI	0035	Murphy	0000	Optonica.....	0062
Lunatron.....	1137	Memorex	0035, 0162, 0037, 0048, 0039, 0047, 0240, 0000, 0104, 0209, 0072, 0278, 0348, 0307, 0569, 1262, 1237, 1162, 1048, 1037, 0579, 0479, 0454, 0046, 0062, 0054	Myryad	0081	Orbit	0072
Lux May	0072			NAD	0240, 0104, 0058	Orion	0184, 0240, 0000, 0104, 0121, 0209, 0002, 0278, 0348, 0352, 1815, 1479, 0742, 0479, 0343, 0295, 0294, 0211, 0208, 0088, 0036
Luxor	0048, 0047, 0104, 0043, 0072, 0315, 0046, 0062	Memphis.....	0072	Naiko	0348, 0642	Orson	0000
LXI	0037, 0000, 0042, 0067, 0054	Mercury	0020	NAP	0039	Osaki	0037, 0000, 0072
M Electronic.....	0037, 0240, 0000, 0038	Metronic	0081	Nebula Elec.	0033	Osume	0072
Magnadyne	0081, 0212	Metz.....	1062, 0162, 0037, 0081, 1562, 0227, 0347, 0454, 0836, 1162, 1262	NEC	0035, 0037, 0048, 0104, 0067, 0041, 0278, 0038, 0008, 0082, 0370, 1137, 1287, 1288	Otake	0209
Magnasonic	0037, 0240, 0000, 0072, 0278, 0020, 0082, 0593, 1278	MGA	0060, 0240, 0043, 0061	Neckermann	0081, 0041, 0208	Otto Versand	0081
Magnavox	0035, 0037, 0048, 0039, 0081, 0240, 0000, 0149, 0642, 1781, 1593, 0618, 0593, 0563, 0110, 0054, 0011	MGN Tech.	0240	Nesco	0000, 0072	Pace	0352
Magnin	0240	Micormay.....	0348	New Funk	0209	Pacific	0000, 0348, 0642, 0742
Magnum	0642	Micromaxx	0209	New Tech	0072	Packard Bell.....	1972
Manesth	0081, 0045, 0209, 0072	Microsoft	1972	Newave	0037	Palladium	0037, 0209, 0041, 0072, 0348
Marantz	0035, 0081, 0209, 0038, 0062, 0295, 1381	Midland.....	0240, 0051	Nikkai	0072, 0278, 0020	Palsonic.....	0000, 0072, 0642
Mark.....	0000, 0278, 0020	Migros	0000	Nikko	0037, 0278	Panama	0035
Marta	0037	Mind	1972	Nikkodo	0037, 0278	Panasonic	1062, 0035, 0162, 0000, 1562, 1807, 1393, 1317, 1308, 1293, 1292, 1262, 1244, 1162, 1035, 0836, 0616, 0615,
Mastec	0642	Minolta.....	0042, 0105	Nikon	0011, 0034		
		Mitsubishi.....	0060, 0048, 0047, 0081, 0000, 0042, 0067, 0043, 0041,	Nishi	0240		
				Niveus Media...	1972		
				Noblex	0240		
				Nokia	0048, 0081, 0240, 0042, 0104, 0041, 0278, 0315, 0036, 0046, 0378		
				Nordmende	0067, 0041, 0320, 0384, 0207		
				Northgate	1972		

	0614, 0513, 0454, 0378, 0367, 0246, 227, 0225, 0077, 0051, 0020	Protech..... 0081, 0072	Rex..... 0041, 0384	Schneider 0037, 0081, 0240, 0000, 0042, 0072, 0278, 0348, 0642, 0352, 0110, 1137
Pathe Cinema ..	0043, 0036	ProVision 0278	RFT 0072, 0020	Scientific Atlanta 0008
Pathe Marconi..	0041	Pulsar 0039, 0240, 0278, 0051	Ricavision 1972	Scott 0184, 0045, 0121, 0043, 0036, 0208, 0210, 0211, 0212, 0593
Penney	0035, 0162, 0037, 0047, 0081, 0240, 0000, 0042, 0067, 0038, 0054, 0077, 1035, 1237	Pulser 0240, 0051	Rio 0034	Sears 0060, 0035, 0162, 0037, 0048, 0039, 0047, 0033, 0045, 0000, 0042, 0104, 0067, 0043, 0209, 0041, 0072, 1237, 0105, 0066, 0065, 0011, 0058, 0054, 0018, 0034, 0046, 0036
Pentax	0042, 0065, 0105	Pye 0081, 0000	Roadstar 0037, 0081, 0240, 0072, 0278, 0038, 0742	Seaway 0278
Perdio	0000, 0209	Qisheng 0060	Royal 0072	SEG 0081, 0240, 0072, 0278, 0642, 0561
Philco	0035, 0081, 0000, 0209, 0072, 0038, 0110, 0479, 0561	Quarter 0046	Runco 0039	SEI..... 0081
Philips	0035, 0162, 0048, 0081, 0045, 0000, 0209, 0384, 0110, 0062, 0034, 0563, 0593, 0616, 0618, 0739, 1081, 1181, 1381	Quartz 0035, 0047, 0046	Saba..... 0041, 0278, 0320, 0384, 0062, 0207	Sei-Sinudyne.... 0081
Phoenix	0278	Quasar 0035, 0162, 0002, 0278, 0077, 0454, 1035, 1162	Saisho 0209, 0348, 0036, 0088, 0208	Seleco 0037, 0041, 0384, 0008, 0020
Phonola.....	0081	Quelle 0081, 0208	Salora 0104, 0043, 0046, 0075, 0443	Semivox 0045, 0209
Pilot	0037	Questar..... 0020	Sampo 0037, 0048	Semp 0045
Pioneer.....	0162, 0081, 0042, 0067, 0058, 1337, 1388, 1390	Radialva..... 0037, 0048, 0081, 0072	Samsung..... 0060, 0240, 0045, 0000, 0038, 0432, 0051, 0053, 0077, 0210, 0212, 0739, 0760, 1014	Sentra 0072, 0278, 0020
Polk Audio.....	0081	Radiola 0081	Samtron 0240, 0643	Setron 0072
Portland 0278, 0020		Radionette..... 0037, 1137	Samurai..... 0020	Sharp 0037, 0048, 0047, 0032, 0000, 0209, 0569, 0062, 0065, 0363, 0807, 0848, 1048, 1285, 1400, 1815
Precision 0058		RadioShack..... 0035, 0162, 0037, 0048, 0047, 0240, 0000, 0104, 0046, 0062, 0066, 1037, 1162	Sanky 0048, 0039	Shinco 0000
Presidian 1593		Radix 0037	Sansei 0048	Shintom..... 0039, 0240, 0000, 0104, 0072, 0208
Prinz 0000, 0088		Randex 0037	Sansui 0240, 0000, 0067, 0209, 0041, 0072, 0002, 0348, 0082, 0271, 0479, 1479	Shivaki..... 0037
Profitronic..... 0081, 0240		Rank 0041	Sanyo 0048, 0047, 0240, 0000, 0104, 0067, 0209, 0348, 0046, 0159, 0368, 0369, 0479, 1137, 1330, 1331	Shogun 0240, 0051
Proline..... 0000, 0278, 0642, 0320, 0615		Rank Arena..... 0041	Saville 0240, 0278, 0352	Shorai 0088
Proscan..... 0060, 0202, 0760, 0761, 1060		RCA..... 0060, 0035, 0048, 0240, 0045, 0000, 0042, 0149, 0320, 0065, 0077, 0105, 0058, 0202, 0211, 0054, 0277, 0760, 0761, 0807, 0880, 1035, 1060	SBR..... 0081	
Proscop 0278, 0844		Realistic 0035, 0162, 0037, 0048, 0047, 0240, 0000, 0104, 0121, 0278, 0046, 0062, 0065, 0066, 1162	ScanSonic 0240	
Prosonic..... 0209, 0278		Reoc 0348	Schaub Lorenz. 0000, 0104, 0041, 0348, 0315	
Protec 0000, 0072		ReplayTV..... 0614, 0616		

Siemens	0037, 0081, 0104, 0320, 0046, 0054, 0347, 0510	Sunstar	0000	Tedalex	0037, 0209, 0348, 0642		1290, 1289, 1145, 1008, 0845, 0828, 0742, 0544, 0366, 0212, 0210, 0066, 0062, 0054, 0008	
Siera	0081	Suntronic	0000	Teknika	0035, 0037, 0000			
Signature	0060, 0035, 0037, 0048, 0000, 0149, 0046, 0065, 0066, 0479	Sunwood	0072	Teleavia	0041			
Silva	0037	Supra	0037, 0278, 0348	Telecorder	0240			
Silver	0278	Susumu	0037	Telefunken	0209, 0041, 0278, 0642, 0320, 0384, 0208, 0593		Tosonic	0278
SilverCrest	0642	SV2000	0000, 0072				Totevision	0037, 0240
Singer	0037, 0240, 0045, 0072, 0348, 0271	SVA	0000				Touch	1972
Sinudyne	0081, 0209, 0352	Sylvania	0035, 0081, 0000, 0043, 0110, 0593, 1593, 1781	Telenet	1784		Towada	0072
Smaragd	0348	Symphonic	0240, 0000, 0002, 0593, 1593	Telestar	0037		Toyoda	0278
Solavox	0020, 0034	Systemax	1972	Teletech	0000, 0072, 0278		Tradex	0081
Sonic Blue	0614, 0616, 0643, 1137	T+A	0162	Tempest	0020		Trakton	0020
Sonneclair	0072	Tagar Systems..	1972	Tenosal	0072		Triad	0278
Sonographe	0046	Taisho	0209, 0088	Tensai	0037, 0000, 0072, 0278		Triumph	0208
Sonolor	0048, 0046, 0062	Tandberg	0278	Tevion	0209, 0348, 0642, 0479		Trix	0037
Sontec	0037, 0278	Tandy	0000, 0104	Texet	0278, 0020		Uher	0240
Sonwa	0642	Tashiko	0037, 0048, 0081, 0240, 0000	Thomas	0000, 0002		Ultra	0045, 0278, 0020
Sony	0035, 0048, 0047, 0032, 0033, 0000, 0067, 1972, 1636, 1448, 1447, 1297, 1296, 1295, 1232, 1032, 0640, 0639, 0636, 0586, 0046, 0034, 0011	Tatung	0048, 0081, 0045, 0000, 0067, 0043, 0209, 0041, 0348, 0352, 0008, 0053, 0366	Thomson	0060, 0067, 0041, 0278, 0320, 0384, 0202		Ultravox	0278
Soundmaster ...	0000	Tchibo	0348	Thorn	0037, 0104, 0041, 0320, 0036, 0443		Unitech	0240, 0051
Soundwave	0037, 0209, 0348	TCM	0348	Tisonic	0278		United	0348, 0742, 1593
Ssangyong	0072	Teac	0037, 0000, 0067, 0041, 0072, 0278, 0307, 0642, 0526, 0593, 0844, 1593	Tivo	0618, 0636, 0739, 1337, 1996		Universum	0037, 0081, 0240, 0000, 0104, 0209, 0348, 1137
Stack 9	1972	Tec	0072, 0020	TMK	0240, 0000, 0036, 0208		Vector	0045
Standard	0278	Tech Line	0072	TNIX	0037		Vector Research	0184, 0038
Stern	0278	Technics	0035, 0162, 0037, 0081, 0000, 0246, 1162	Tocom	0240		Vextra	0072
Strong	0271	TechniSat	0348	Tokai	0037, 0104, 0041, 0072		Victor	0067, 0041, 0384, 0008, 0370, 1283, 1299
STS	0042, 0105	Technosonic	0352	Topfield	1959, 2045		Video Concepts	0045, 0061, 0210, 0242
Sunkai	0209, 0278, 0348, 0295	Teco	0035, 0037, 0048, 0041, 0038	Topline	0348		Video Pro	0020
				Toshiba	0081, 0240, 0045, 0000, 0042, 0067, 0043, 0209, 0041, 0384, 0352, 0432, 1384, 1386, 1972, 1325, 1323, 1996,		Video Technic...	0000
							Video Track	0443
							Videomagic	0037
							VideoPro	0020
							Videosonic	0240, 0000, 0072
							Viewsonic	1972
							Villain	0000
							Voodoo	1972

Wards 0060, 0035, 0037,
0048, 0039, 0047,
0081, 0033, 0240,
0045, 0000, 0042,
0043, 0041, 0072,
0038, 0149, 0046,
0058, 0018, 0062,
0065, 0011, 0212,
0479, 0760

Watson 0081, 0642, 0352

Weltblick 0037

Wharfedale..... 0642, 0593, 0615

White Westinghs 0000, 0209, 0072,
0278, 0479

World 0209, 0002, 0348,
0479

XR-1000 0035, 0240, 0000,
0072, 0208

Yamaha 0041, 0038

Yamishi..... 0072, 0278

Yokan 0072

Yoko 0037, 0240, 0072,
0020

Yoshita 0072

Zenith 0037, 0039, 0033,
0000, 0209, 0041,
0278, 0011, 0034,
0479, 1137, 1139,
1479

ZT Group..... 1972

ZX..... 0209, 0348, 0352

A-ACC

Accurian 2502

Altec Lansing ... 2500, 2501

Apple 2503, 2505

DLO..... 2504, 2509

Griffin 2508

iPort 2506, 2507

NaviPod..... 2505

Sonance 2506, 2507

TEN Technology 2505

V-ACC

ABS 1272

Accurian 1653

Alienware 1272

Amino 1481

Axonix 1447

Buffalo 1739

CyberPower..... 1272

D-Link 1554, 1731

Dgtec 1363

Epson 1563, 1650

Gateway 1272

Hewlett Packard 1272, 1267

Howard Comps 1272

HP..... 1272, 1267

Hush 1272

iBUYPOWER ... 1272

Keyspan 1344

KoolConnect ... 1481

LG..... 1415

Linksys 1272, 1365

Macro Image Tech.1383

Media Center PC 1272

Microsoft 1272, 1805, 2049

Mind 1272

Motorola 1363

MyHD 1383

Niveus Media.... 1272

Northgate 1272

Packard Bell 1272

Panasonic 1120

Philips 1218

Pinnacle Systems 1447

Pioneer..... 1010

ReQuest..... 1245

Ricavision 1272

Roku 1486

Samsung..... 1190, 1490

Sensory Science 1126

Sharp 1010

Sony..... 1272, 1324, 1364

Stack 9..... 1272

SureWest 1481

Sylvania 1563

Systemax 1272

Tagar Systems . 1272

Toshiba 1272

Touch 1272

Viewsonic 1272, 1329

Vizio 1126

Voodoo 1272

Xbox..... 1805, 2049

Zinwell..... 1363

ZT Group..... 1272

R-ACC

Bose..... 1629

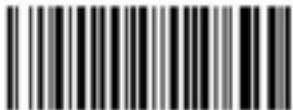

312515

BOSE[®]
Better sound through research[®]

©2008 Bose Corporation, The Mountain,
Framingham, MA 01701-9168 USA
AM312515 Rev.01