

# STOVES

MAKE A STATEMENT

## USER GUIDE

A commitment to:

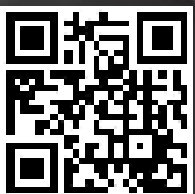

**Countries of destination:**

GB - Great Britain

IE - Ireland

DE - Germany

ES - Spain

FR - French

IT - Italy

PL - Poland

NL - Netherlands

SE - Sweden

CN - China

NZ - New Zealand

AU - Australia

To contact Stoves about your appliance, please call:



**Customer Care Helpline**

**0344 815 3740**

In case of difficulty within the UK



**Warranty Registration**

**0800 952 1065**

\*Please call our Customer Care team for extended warranty



**Spares Store**

**0344 815 3745**



To register your appliance online:

**[www.stoves.co.uk](http://www.stoves.co.uk)**



To contact us by email:

**[gdhainfo@gdha.com](mailto:gdhainfo@gdha.com)**



To register your appliance by mail:

**Please complete the warranty card and return to the address supplied**



Alternatively general, spares and service information is available from our website at: **[www.stoves.co.uk](http://www.stoves.co.uk)**

Calls are charged at the basic rate, please check with your telephone service provider for exact charges

Your new appliance comes with our **12-month guarantee**, protecting you against electrical and mechanical breakdown. To register, please complete the registration form included, register online or by phone. For full terms & conditions of the manufacturer's guarantee, please refer to the website above. In addition, you may wish to purchase an extended warranty. A leaflet explaining how to do this is included with your appliance.

Our policy is one of constant development and improvement, therefore we cannot guarantee the strict accuracy of all of our illustrations and specifications. Changes may have been made subsequent to publishing.

Glen Dimplex Home Appliances, Stoney Lane, Prescot, Merseyside, L35 2XW

# INTRODUCTION

---

Thank you for buying this British-built appliance from us.

This user guide book is designed to help you through each step of owning your new product.

Please read it carefully before you start using your appliance, as we have endeavored to answer as many questions as possible, and provide you with as much support as we can.

General information, spares and service information is available from our website.

If you should find something missing from your product or have any questions that are not covered in this user guide, please contact us (see contact information inside the front cover).

## European Directives



As a producer and a supplier of cooking appliances we are committed to the protection of the environment and are in compliance with the WEEE directive. All our electric products are labelled accordingly with the crossed out wheeled bin symbol. This indicates, for disposal purposes at end of life, that these products must be taken to a recognized collection points, such as local authority sites/local recycling centres.

This appliance Complies with European Community Directives (CE) for household and similar electrical appliances and Gas appliances where applicable.

This appliance conforms to European Directive regarding Eco design requirements for energy-related products. Our policy is one of constant development and improvement, therefore we cannot guarantee the strict accuracy of all of our illustrations and specifications - changes may have been made subsequent to publishing.

## Disposal of Packaging Material

The packaging materials used with this appliance can be recycled. Please dispose of the packaging materials in the appropriate container at your local waste disposal facilities.

### **UK ONLY GAS WARNING:**

If you smell gas, Do not try to light any appliance. Do not touch any electrical switch.  
Call the Gas Emergency Help line at **0800 111999**

## SAFETY

---

### WARNING

- If the hob surface is cracked, broken or shattered, switch off the appliance to avoid the possibility of electric shock and call for a service engineer's visit.
- The appliance and its accessible parts become hot during use. Care should be taken to avoid touching heating elements. Children less than 8 years of age shall be kept away unless continuously supervised. This appliance can be used by children aged from 8 years and above and persons with reduced physical sensory or mental capabilities or lack of experience and knowledge if they have been given supervision or instruction concerning the use of the appliance in a safe way and understand the hazards involved. Children shall not play with the appliance. Cleaning and user maintenance shall not be made by children without supervision.
- Do not use a steam cleaner on any cooking range, hob or oven appliance.
- Metallic objects such as knives, forks, spoons and lids should not be placed on the hob surface since they can get hot.
- After use, switch off the hob element by its control and do not rely on the pan detector.
- The appliance is not intended to be operated by means of an external timer or separate control system.
- If the cooker is placed on a base, measures have to be taken to prevent the appliance slipping from the base.
- Unattended cooking on a hob with fat or oil can be dangerous and may result in fire.
- NEVER try to extinguish a fire with water, but switch off the appliance and then cover the flame with a lid or damp cloth.
- Danger of fire: Do not store items on the cooking surfaces.
- Only use hob guards designed by the manufacturer of the cooking appliance or indicated by the manufacturer of the appliance in the instructions for use as suitable or hob guards incorporated in the appliance. The use of inappropriate hob guards can cause accidents.
- This induction hob complies with the applicable EMC and EMF

## SAFETY

---

standards. Therefore it should not interfere with other electronic units. Persons fitted with a pacemaker or any other electrical implant should clarify with their doctor or the producer of the implant, whether there implant is adequate and fail-safe. Please place pans centrally on the cooking zones. The British Heart Foundation provide additional advice regarding using induction hobs when a pacemaker is fitted.

- During use the appliance becomes hot. Care should be taken to avoid touching heating elements.
- Do not modify this appliance.
- Do not place articles on or against the appliance.
- Servicing should be carried out only by authorised personnel.

### CAUTION

- The cooking process has to be supervised. A short term cooking process has to be supervised continuously.
- This appliance must not be installed behind a decorative door in order to avoid overheating.

### • **Fire Safety Advice**

If you do have a fire in the kitchen, don't take any risks - get everyone out of your home and call the Fire Brigade.

### **If you have an electrical fire in the kitchen:**

- Pull the plug out, or switch off the power at the fuse box - this may be enough to stop the fire immediately
- Smother the fire with a fire blanket, or use a dry powder or carbon dioxide extinguisher
- Remember: never use water on an electrical or cooking oil fire.

### • **Other Safety Advice**

- There is a risk of electric shock, so always make sure you have turned off and unplugged your appliance before starting. Always allow the product to cool down before you change a bulb.
- This appliance must be earthed.
- The appliance must never be disconnected from the mains supply during use, as this will seriously affect the safety and performance,

## SAFETY

---

particularly in relation to surface temperatures becoming hot and gas operated parts not working efficiently.

- **GAS WARNING!** - If you smell gas: Do not try to light any appliance, Do not touch any electrical switch. Contact your local gas supplier immediately.

# USING YOUR APPLIANCE

## Getting to know your product

**Note:** Your appliance layout may differ depending on the model.

### Hob 90/100/110cm

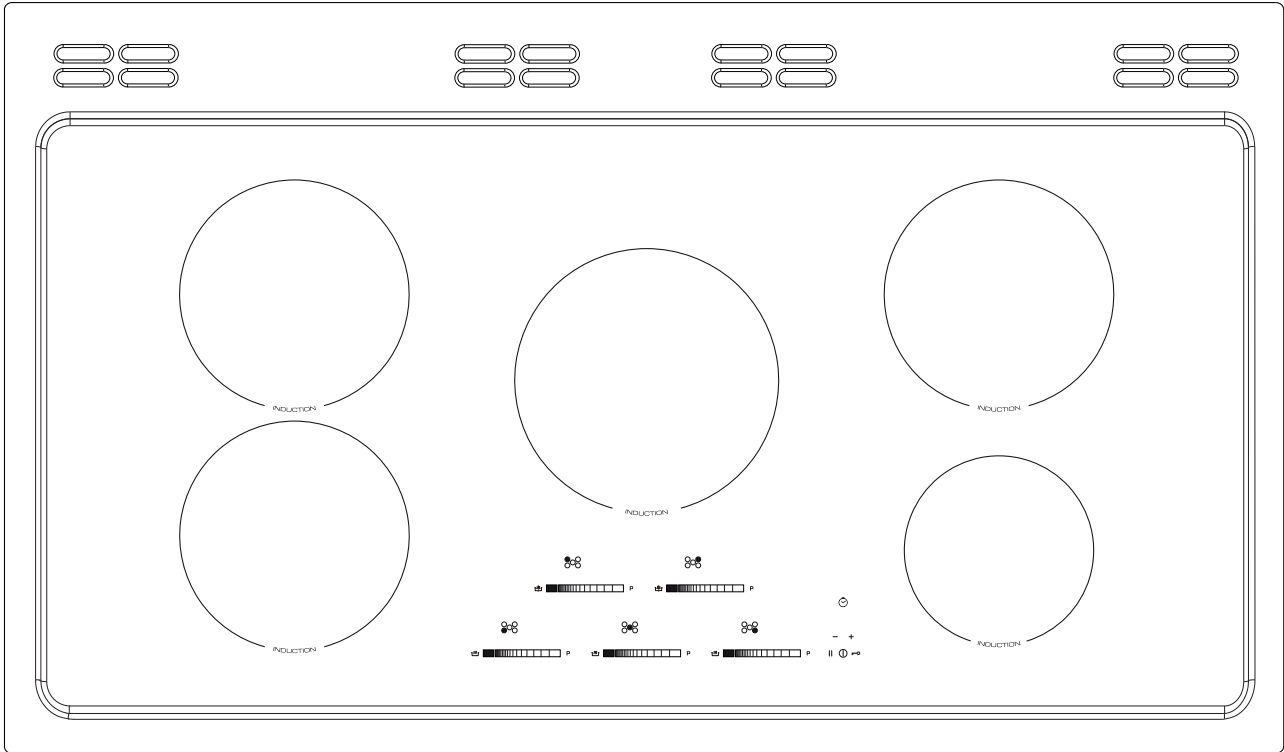

### Hob control panel

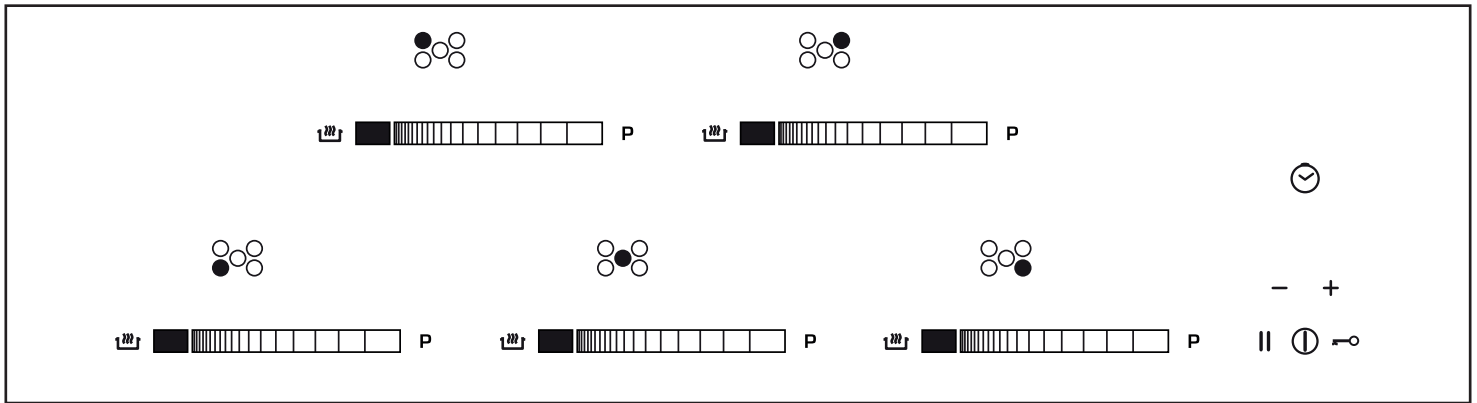

### Control Panel 90cm

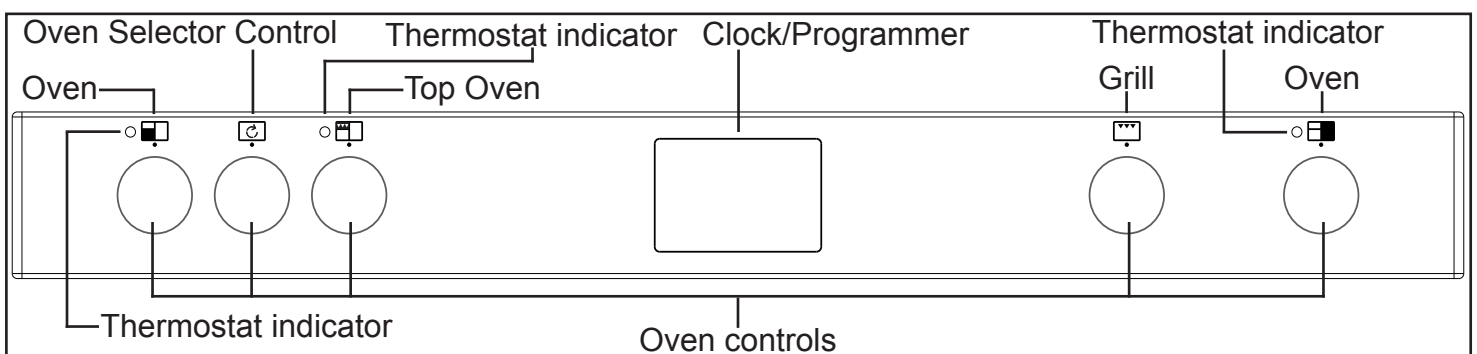

# USING YOUR APPLIANCE

## Control Panel 90cm (Deluxe)

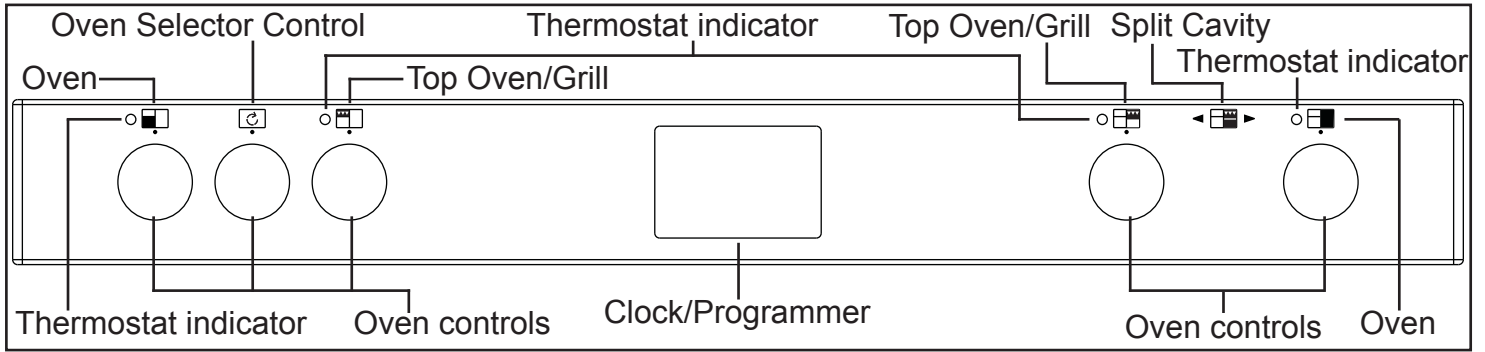

## Control Panel 100/110cm

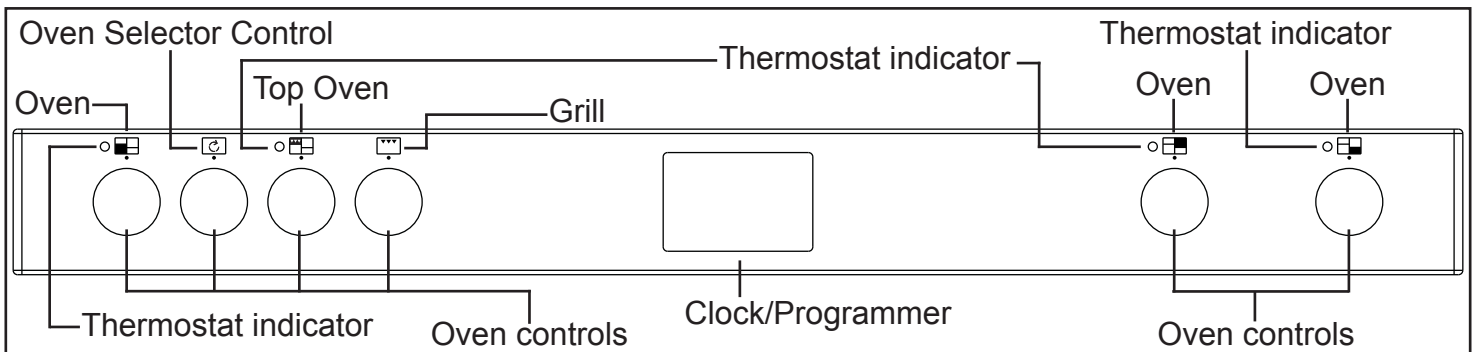

90cm

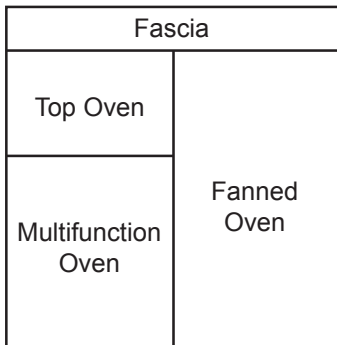

90cm Deluxe

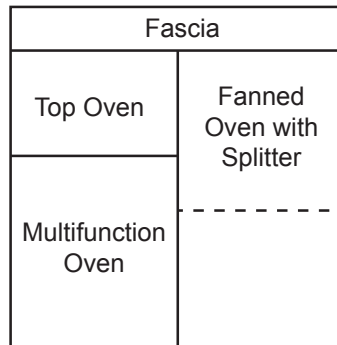

100/110cm

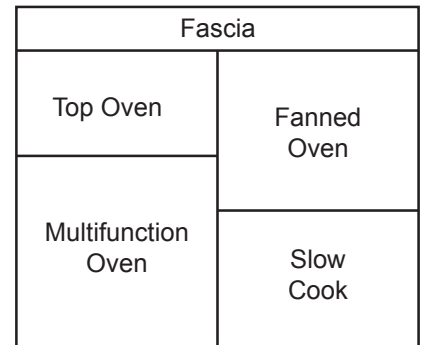





















# USING YOUR APPLIANCE

## Appliance functions

**Note:** Your oven may not have all of the functions shown here. We recommend for best cooking results, please preheat your oven for 15 minutes and 3-5 minutes for grilling.

Only slow cook using the dedicated function. When using the multifunction oven, firstly select the fanned oven feature.

	Intense Baking		Defrost
	Base Heat with Fan		Conventional Oven
	Slow Cook		Fanned Oven
	Fanned Grill		Low Grill
	Oven Selector Control		Single Grill
	Conventional Grill		Dual Grill
	Top Heat		Base Heat
	Lights Only		Pizza Function
	Bread Proving		Keep Warm

### Oven Selector Control

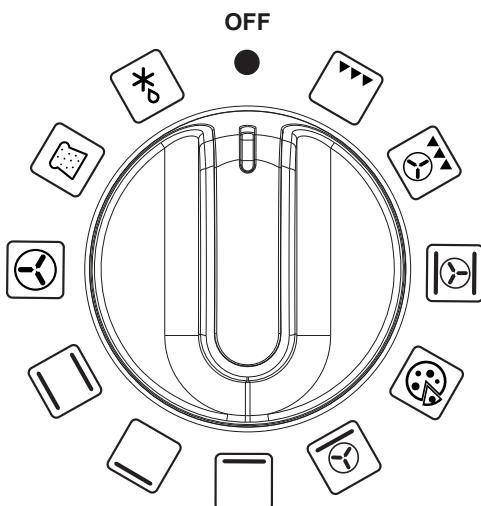

### Electric oven

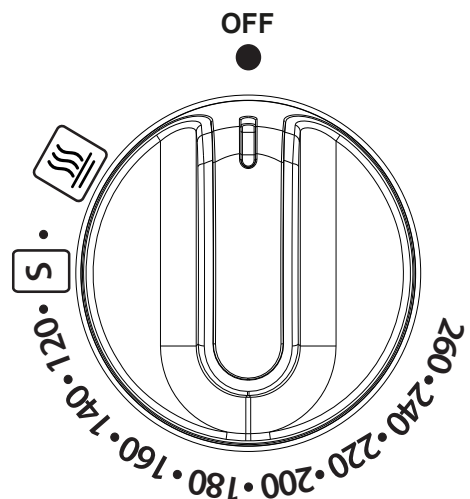

# USING YOUR APPLIANCE

---

## Ovens and Grill

When using the top oven or main oven, the white thermostat indicator light will come on until the selected temperature is reached.

When the Top oven/grill or grill is switched on, the cooling fans come on to keep the fascia and control knobs cool during cooking/grilling. The cooling fans may operate when the main ovens are in use, depending on the temperature setting. The fans may continue to operate for a period after the oven/grill has been switched off. During use the fan may cycle on and off, this is normal.

**Important:** Never put items directly on top the base of the oven, or cover the oven base with foil, as this may cause the element to overheat. Always position items on the shelf.

The left hand main oven will not operate if the programmer is set to Auto, see clock/programmer section.

## Top Oven - Grill

THE DOOR **MUST** BE CLOSED WHEN THE GRILL IS USED FOR FANNED AND CONVENTIONAL GRILLING

## Main Oven - Grill

THE DOOR **MUST** BE CLOSED WHEN THE GRILL IS USED FOR FANNED AND CONVENTIONAL GRILLING.

## Tall Oven - Grill (90cm Deluxe only)

THE DOOR **MUST** BE OPEN WHEN THE GRILL IS USED.

# USING YOUR APPLIANCE

## Grill pan and trivet

The grill trivet (inside the grill pan) can be inverted to give a high or low position, or it may be removed. The speed of grilling can be controlled by selecting a higher or lower shelf position, or adjusting the grill setting.

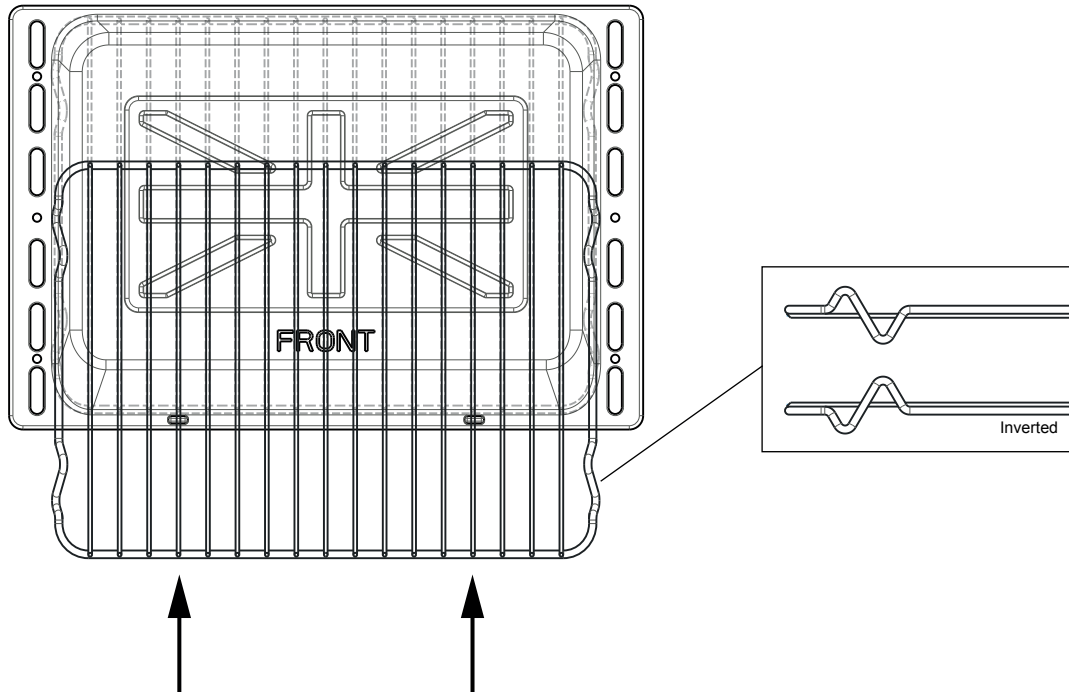

# USING THE HOB

## USING THE HOTPLATE

- Commercial simmering aids should not be used as they create excessive temperatures that can damage the surface and may cause a hazard.
- Do not place aluminium foil or plastic utensils on the ceramic glass, as they may melt and damage the surface.
- Do not use the ceramic glass hotplate surface for storage.
- When cooking with fat or oil, never leave unattended.
- Turn pan handles to a safe position, so they are out of reach of children, not overhanging the appliance, and cannot be caught accidentally.
- Position pans over the centre of the hotplate elements.
- Do not use the hob as a chopping board or a storage area, as this increases the likelihood of it being damaged - e.g.; plastic utensils placed on a warm hob may melt onto it, and damage the ceramic glass surface.
- Be careful when cooking foods in salted water, or foods containing large amounts of sugar, syrup or jam - if they are spilled onto hot areas of the hob they may damage it.
- Lift pans onto and off the surface, rather than sliding them across the surface, to avoid marks and scratches.
- If you use a wet paper towel to remove spills from a warm heating area of the hob, be careful to avoid steam burns.
- Do not use abrasive powder cleaners, metal wire wool pads, impregnated plastic pads, detergents, bleaches, bath stain removers, or chemical oven cleaners; all these types of products will damage the ceramic glass.

The functions of the hob comply with the applicable standards on electro-magnetic interference

Your induction cooking hob thus complies fully with the statutory requirements (Directive 2004/108/EC). It is designed to not interfere with the functioning of other electrical equipment as long as these also comply with the same regulations.









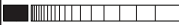

Your induction hob generates magnetic fields in its immediate vicinity.

So that there is no interference between your cooking hob and a pacemaker, the pacemaker must be designed in compliance with the appropriate regulations.

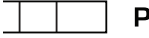
In this respect we can only guarantee the compliance of our own product. You can ask the manufacturer or your doctor about the compliance or any incompatibilities of your pacemaker.

**Once you have powered on the induction hob, you have 10 seconds to set the power or use the timer, before the induction hob is automatically switched off.**

# USING THE HOB

Feature	Symbol	Description
Eco power		Induction Power is the most energy efficient means of cooking food, provides fast heat up and boiling times
Slide Control		Slide your finger along the graphic or simply touch the graphic at the power level you require.
Digital display		Secret till "lit" hob display
No. of power levels	<b>13</b>	Precise and repeatable control settings
Special Functions		Three preset temperature controls set at 42°C, 70°C, and 94°C. Ideal for Melting chocolate, Warming and Rapid Simmer respectively
Central Power On/Off		Power On / Off for the Induction hob
Power Boost		Temporarily boost the power to a cook zone by a massive 60%
Pause/un-pause		This button pauses cooking with one touch. (cuts power)
Minute Minder		To a maximum time of 9 hours 99 minutes, you can time anything
Auto Time Switch's Off all 5 zones	<b>Yes</b>	All five zones can be simultaneously timed to turn off automatically
Key Lock		To prevent accidentally changing settings, press the key graphic to lock the controls
Pan Detection		Lets you know if the correct pans are being used and helps to save energy. When a pan is lifted off the zone, the power is automatically cut.
Overheat Pan Detection	<b>Yes</b>	Helps prevent cookware from overheating providing an additional level of safety not available on other types of hobs
Child lock	<b>Yes</b>	Prevents unintentional operation of the hob
Residual Heat Indications		Warns you against hot surfaces but also indicates that the residual heat which can be used as a temporary warm zone
Holiday Shutdown	<b>Yes</b>	No operation is required - the hob will turn its self off if left

# USING THE HOB

---

## About the induction hob

The induction hob provides the most energy efficient hob technology available.

The induction system provides superior heat up and cool down times for pans - you get fast, precise, repeatable power control.

As induction only heats up the pan, there is no lost heat from the cooking process, which in turn, limits the heat generated in the kitchen.

## Auto Power Tuning

Induction hobs have a unique power tuning system that automatically tunes the power to the size of the pan base this ensures energy isn't wasted.



**Small Pan**



**Large Pan**

## Touch Controls

The touch controls for your induction have been designed to provide you with finger touch control of your hob, providing accurate and repeatable power settings for cooking and an easy clean surface that can be easily wiped over.

Each cook zone displays its individual power setting.

## Using the Touch Controls

To select a cook zone or the timer, simply touch the graphic slider, using the flat of your finger, not the tip. The controls respond to touch, so you don't need to apply any pressure.

Once you have powered on the induction hob, you have 10 seconds to set the power or use the timer.

If the red displays disappear, simply press the power button again.

Always ensure the control area is clean, dry and free from any objects (e.g. utensils, tea towels and cloths). Spillages and water may make the controls difficult to operate.

## Basic Hob Function

### Turning on the hob.

- Use the on/off button.

### Activating a cook zone.

Select the slider and operate by sliding your finger across the graphic or touching the graphic at the desired power level (0-9).

### Modifying the power setting whilst cooking

#### Turning off individual cooking zones.

1) Decrease the power setting until the display shows **0**. If the cook zone surface is hot to touch, **H** will replace **0** in the display.

# USING THE HOB

## Induction controls

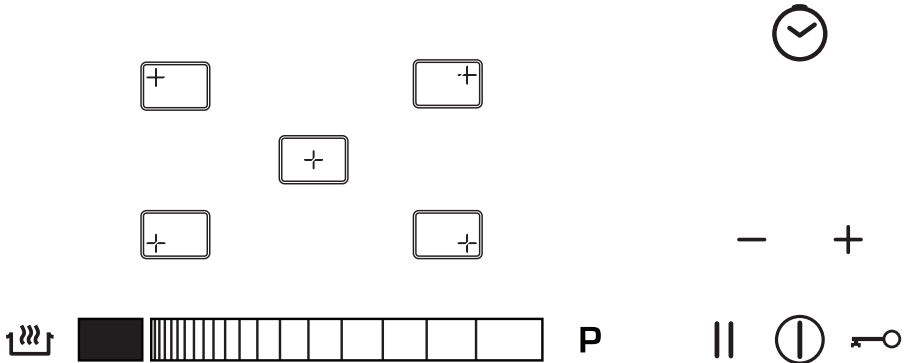

### Power Boost

This feature, temporarily boost the power to a cook zone by 60%.

The power boost is a function that can be used to temporarily boost the normal maximum power for a cook zone by borrowing the available power from a "paired zone".

All the cook zones have this function

The Power Boost is activated by sliding or touching the P

**Note** The Power Boost function will only operate for a limited time and is also under thermal control. This means the power boost will deactivate automatically if the product is hot, to protect the internal electronic components of the hob and to prevent the cookware from overheating.

### Smallest recommended pan diameter

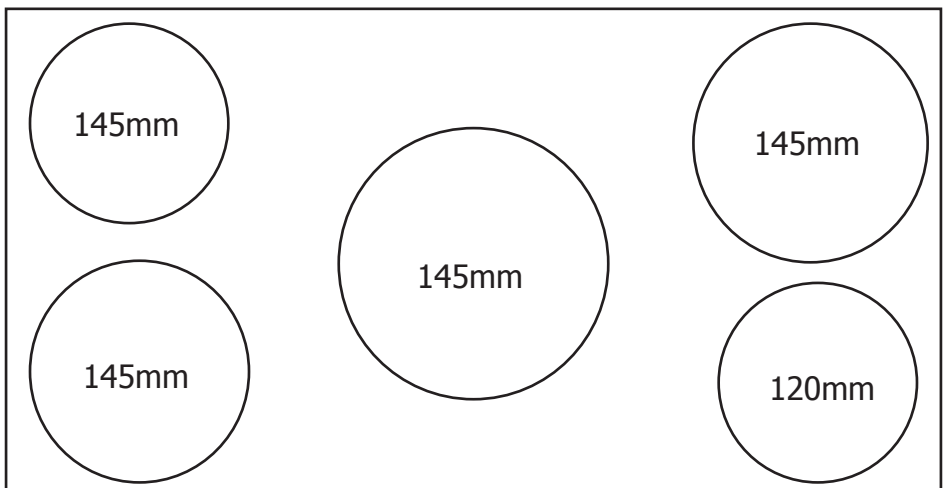

# USING THE HOB

## Special Function Key



Touch once for Function 1 94 °C - Ideal for a Rapid Simmering.



Touch twice for Function 2 70 °C - Ideal for keeping warm



Touch three times for Function 3 42 °C - Ideal for melting or sauces

## Pan detection

When a zone has been activated but no pan has been placed on the cook zone, the zone will recognise that there is no pan in position. It also means the hob only uses power when a suitable pan is placed on the zone. This reduces the energy used during the cooking process, i.e. when you take your pan off the zone the hob automatically reduces the power, and only switches back on when you replace the pan.

**Note** If the  symbol does not disappear when a pan is placed on the zone it indicates that the pan is not suitable for induction cooking.

## SPECIAL HOB FUNCTIONS

### On/Off switch

The central on/off switch enables all of the cooking zones to be switched on/off simultaneously at a touch of a button, so when you have finished cooking or are called away from the kitchen for any reason you can be safe in the knowledge that everything is under control and safe.

### To Operate

1) Select the on/off key. The key needs to be pressed for at least 1 second to activate, this is to ensure that the hob cannot be activated unintentionally.

### Note:

All other keys only need to be pressed for 0.3 seconds to be activated/deactivated.

### Note:

“H” will appear on any cook zone display that is still hot to touch.

## Using the Timer



The timer has up to 7 timers. 6 timers to be assigned to the cooking zones and one independent timer called egg-timer.

The displays show the remaining time until the alarm is activated.

All timers work as count down timers. The operation range is between 1 min to 2h 59min. For times less than 59mins, the display is exact to the second.

Before activating a timer the control has to be switched on. Switching the control off deactivates cooking zone related timers. The egg timer stays active after switching the control off.

A symbol next to the zone will be lit when a timer is set to that zone

### Activating Cooking Zone Timer

To activate the timer, press both the plus (+) and minus (-) keys together.

A timer can be activated for each active cooking zone. After selecting the timer the cooking zone related luminous symbol is fully lit and the timer display shows 0.00. For the following 10 sec it is now possible to assign a timer value to the active cooking zone. After 10sec without input, the timer function is deactivated and the display is switched off again. Using the



# USING THE HOB

---

timer selection key again (as long as no value was set) the next active cooking zone can be selected.

## Setting a timer value

- By pressing the timer keys, a timer value can be set. If the timer-plus-key is pressed first the display starts with 1min and can be increased in 1min steps. If the timer-minus-key is pressed first the timer starts with 15 min and can be decreased in 1 min steps.
- Pressing the key permanently speeds up the timer adjustment. The speed will also increase while the key is held. (the time between two time steps reduces).
- If a timer has expired the timer alarm is activated and the assigned cooking zone is immediately switched off.
- The cooking zone display shows 0 or H.

## If no user input stops the alarm signal it will be on for maximum 2 minutes.

The alarm can be deactivated by switching off the control using the main switch or by pressing the two timer keys or it will be deactivated automatically after 2 minutes.



## Switching off a timer or changing the time setting

The timer value can be modified at any time by selecting the timer and then by pressing the (+ or -) timer key.

To stop an active timer the value can be set to 0. Pressing Plus and Minus simultaneously for 2 seconds also resets the timer value to 0.00.

## Minute Minder

The minute minder buzzes when the time set has expired. It does not switch off any zone.

## To operate:

- 1) Turn on the hob, using the on/off key.
- 2) Select the timer by pressing the + and - keys together (do not activate any cook zone).
- 3) Set the right hand digit up to 9 minutes (Single Minutes Units) and wait a couple of seconds.
- 4) The display will now indicate for you to set the left hand digit, up to 90 minutes (10 Minute Units).
- 5) The timer is now set and begins counting down. (No zone indicator light should be set).
- 6) You can now use the hob as normal.

## When the time is up.

- 1) The corresponding indicator in the timer display will flash, the timer will beep.
- 2) Touch any control to stop the beeping.

## Warning!

Never leave the hob unattended when in use, even when you have set the timer to turn off the cook zone.

## Additional timer information

To modify or cancel a timer setting follow steps 1) to 5) above.

To set the timer for additional zones follow steps 1) to 5) above.

If multiple zones have been set for timed operation, the timer display will always display the time for the cook zone with the shortest time remaining.

To check the timer setting for a different cook zone, simply select the required cook zone, the remaining time will briefly appear in the timer display.

# USING THE HOB

## Pause key

### Warning!

Don't leave pans on the hob when you're not around - take them off the heat if you have to leave the kitchen (even if you think it will only be for a moment, while you answer the door or phone) or you can use the Pause Key.

The Pause key is ideal for unexpected interruptions when cooking. With this button you can pause all cooking settings (Cuts power) with one touch.

## To Operate

1) Press the pause key.

### Note:-

All cook zones functions will pause (no power) and will be displayed for each cook zone.

2) To restart, press the pause button and then within 10sec use the cooking zone slider left to the timer (slide from low to higher levels).

Note:- All cook zones will automatically resume to the previous settings.

## Cookware for the induction hobs

Cookware for the induction cooking zones must be made of metal and have magnetic properties. The base must also be the correct diameter.

Suitable Cookware for Induction Hobs	Unsuitable Cookware
Enamelled steel pots with a thick base	Pots made of copper, stainless steel, aluminium, oven-proof glass, wood, ceramic and terra-cotta.
Cast iron pots with an enamelled base	
Pots made of multi layer stainless steel, rustproof ferrite steel or aluminium with a special base	
Pans marked for use with induction	

## How to establish the suitability of a pan

Check your pans with a magnet. If it sticks and it's the correct diameter, it's suitable for use with induction. Also with pans that bear the symbol for suitability for cooking with induction.

**Note** - when using certain pans, you may get various noises from the pans. This is due to the design of the pans and does not effect the performance or safety of the hob.

Pans should not be allowed to come into contact with coloured trims during use as this may cause discolouration of the surface

# USING THE HOB

## Child Lock

This feature is to help prevent accidental switching on of the hob, especially by young children.

To activate:

Press the key lock button and pause button together, and then release them. Complete activation by pressing the key lock button again.

To deactivate:

Press the key lock button and pause button together, and then release them. Complete activation by pressing the pause button again.

## Residual Heat indicators

If when the cook zone is switched off the glass surface is above 60°C, H will be displayed in the cook zone display until the glass surface drops below approximately 55°C.

This feature not only warns you against hot surfaces but also indicates that there is residual heat which can be used as temporary warm zone.

**Note** - The cook zone itself does not heat up, but the ceramic glass does get hot because of the hot pan conducting heat back onto the hob glass.

## Overheat Pan Protection

The hob is equipped with additional safety systems that help to prevent cookware from overheating, providing an additional level of safety not available on conventional hobs (such as gas and ceramic hobs).

Approximate Glass Surface Temperature (°C)	Intelligent hob safety system
200	Reduces Power Boost setting to Power Level 9
250	Reduces power to 60% of power level setting
270	Switches cook zone off
300	Switches whole appliance off

**Note** - The safety temperature control of the pans is only possible with quality flat bottomed pans suitable for induction cooking. Poor quality pans can create air gaps between the glass and the pan, which affects the accuracy of the temperature control.

## Auto Stand by (Holiday Shut Down)

The hob will automatically switch itself off if left unattended.

## Cooking guide



For best cooking results, follow the examples in the guide below, bearing in mind that settings 8 and 9 are maximum positions and should only be used for deep frying and bringing up to the boil quickly.

# USING THE HOB

Preparation	Very fast frying		Fast	Medium		Slow	Simmering, re-heating		Keeping warm
	9	8	7	6	5	4	3	2	1
Soup									
Thin soup					✓				
Thick soup						✓			
Fish									
Court-Bouillon			✓						
Deep fried					✓				
Sauces									
Thick, flour based							✓		
Buttery, containing eggs								✓	
Vegetables									
Spinach				✓	✓		✓		
Pulses									
Boiled potatoes						✓			
Carrots				✓	✓				
Saute potatoes				✓	✓				
Frozen vegetables						✓			
Meat									
Thin cuts of meat	✓								
Fried steak		✓							
Other types of cooking									
Deep frying: frozen chips	✓								
Deep frying: fresh chips	✓				✓				
Pressure cooking	✓					✓			
Stewed fruit	✓	✓							
Pancakes								✓	
Custard									✓
To melt chocolate						✓			
Jam									
Milk			✓						
Fried eggs			✓						
Pasta	✓								
Re-heating baby food							✓		
Rice pudding								✓	
Keeping food warm									✓
Stews								✓	

# USING THE HOB

## Troubleshooting with the Induction Hob

Code	Problem	Possible Cause	Solution
	Hob is not working  in display	Child lock is activated	Deactivate child lock
	Power boost not working	The appliance is hot, power boost is deactivated when the appliance is hot to protect the electronics and prevents the pans from overheating	Allow the appliance to cool
ER21	Control unit cuts off after program setting	Electronics overheating	Allow the appliance to cool
ER400			Check mains cable connection and terminals at the terminal block are wired correctly
E2	Overheating of induction coil	Pan overheating	Remove pans and allow to cool
E8	Fan blocked or faulty	Fan inlets are blocked or faulty fans	Check fan inlet at the rear of the appliance
E6	Error on power board	No power to power board	Please call Customer Care
ER03 and continuous tone or 	Water or pans on the glass above the user controls	Water or cookware on the glass over the touch control sensors	Clean any water on surface above user controls/display

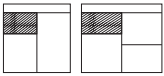

# USING THE GRILL

## BEFORE YOU START GRILLING. . . .

Before you use the grill, make sure you have placed the grill shelf in the position you need as once the grill is on you may injure yourself if you try to move the shelf.

- Do not close the door while the grill is in use.
- Turn the top oven control knob to the required grill setting.
- Turn the grill control knob (if fitted) to the heat setting you require.
- To switch off, return the control knob(s) to the 'off' position.
- The cooling fan will come on during use, and may continue to run for some time afterwards.
- To adjust your results, you can turn the grid over, or remove it altogether.
- The dual grill uses all of the top element and is ideal for grilling large quantities of food.
- The single grill uses part of the element only, and is better suited to grill smaller amounts of food.

## The grill pan

This appliance comes with a grill pan and trivet.

## Shelf & Trivet adjustments

Speed of grilling can be adjusted by changing the shelf position or the turning the trivet.

- High: For thin foods and toasting.
- Low: For thicker meat pieces.

## Aluminium Foil

Never cover the grill pan or grill trivet with foil, or allow fat to build up in the grill pan, as this creates a fire hazard.



**Warning:** Accessible parts may become hot when the grill is in use. Children should be kept away

## Types of grill

Dual grill: has two grill elements which can be used together, or as a single grill.



For best results:  
Pre-heat the single grill for 5 minutes and the dual grill for 3 minutes.

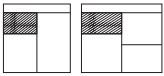

## USING THE GRILL

**i** As with any cooking guide, all times are approximate and can be adjusted to suit personal taste.

<b>Food Type</b>	<b>Time Approx (mins)</b>
<b>Bacon</b>	8-15
<b>Sausages</b>	12 - 15
<b>Chops</b> <ul style="list-style-type: none"><li>• Lamb</li><li>• Pork</li></ul>	10 - 15 15 - 25
<b>Toast</b> <ul style="list-style-type: none"><li>• 2 rounds</li><li>• 4 rounds</li></ul>	1 - 2 (per side) 1 - 2 (per side)
<b>Bread products</b> <ul style="list-style-type: none"><li>• Buns</li><li>• Tea cakes</li></ul>	1 - 2 (per side) 1 - 2 (per side)
<b>Cheese on toast</b> <ul style="list-style-type: none"><li>• 2 rounds</li><li>• 4 rounds</li></ul>	4-5 4-5
<b>Fish</b> <ul style="list-style-type: none"><li>• fillets</li></ul>	10 - 15
<b>Chicken</b> <ul style="list-style-type: none"><li>• fillets</li></ul>	20 - 30
<b>Beef Steaks</b> <ul style="list-style-type: none"><li>• rare</li><li>• medium</li><li>• well done</li></ul>	7 - 10 10 - 15 15 - 20
<b>Gammon Steaks</b>	12 - 15

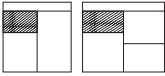

## USING THE TOP OVEN

---

**When you are cooking keep children away from the vicinity of the oven.**

**Caution:** The top element gets extremely hot when in use, so take extra care to avoid touching it.

The top oven is a conventional oven.

Note: The top oven is not controlled by the programmer.

### To turn on the top oven

Turn the temperature control knob until the required temperature is selected.

The white thermostat indicator will come on until the selected temperature is reached, and then go off. It will turn on and off periodically as the thermostat operates to maintain the selected temperature.

To switch off, return the top oven control knob to the off position.

**Important:** Never put items directly on the base of the oven, or cover the oven base with foil, as this may cause the element to overheat. Always position items on the shelf.

### The cooling fan

When the top oven is switched on, you will hear the cooling fan come on - this keeps the fascia and control knobs of the appliance cool during cooking. The fan may continue to operate for a period after the oven control has been switched off.

### Preheating

The oven must be preheated when cooking frozen or chilled foods, and we recommend preheating for yeast mixtures, batters, soufflés, and whisked sponges.

Preheat the oven until the indicator light switches off for the first time, this will take up to 15 minutes depending on the temperature selected.

If you are not preheating the oven, the cooking times in the following guide may need to be extended, as they are based on a preheated oven.

### Shelf positions

When cooking frozen or chilled food, use the highest possible shelf position, while allowing some clearance between the food and the top element.

The oven shelf must be positioned with the up-stand at the rear of the oven and facing up. Position baking trays and roasting tins on the middle of the shelves, and leave one clear shelf position between shelves, to allow for circulation of heat.

### When using the top oven

As part of the cooking process, hot air is expelled through a vent at the top of the oven(s). When opening the oven door, care should be taken to avoid any possible contact with potentially hot air, since this may cause discomfort to people with sensitive skin. We recommend that you hold the underneath of the oven door handle.



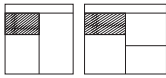

# USING THE TOP OVEN

## TOP OVEN BAKING GUIDE

### Cooking times

These times are based on cooking in a preheated oven.

These cooking times are approximate, due to the size and type of cooking dish and personal preferences.

### Shelf positions

As a general guide, when cooking frozen or chilled food, use the highest possible shelf position, while allowing some clearance between the food and the top element. Follow the instructions given on packaging.

### Cooking temperatures

The temperature settings and time given in the Baking Guides are based on dishes made with block margarine. If soft tub margarine is used, it may be necessary to reduce the temperature setting. If a recipe gives a different temperature setting to that shown in the guide, the recipe instruction should be followed.

Because the top oven is more compact, it may be necessary to reduce cooking temperatures specified in recipes by up to 20°C.

Use the baking guide as a reference for determining which temperatures to use.

Item	Temperature (°C)	Shelf Position	Approximate cooking time
Small cakes	180	1	15 - 20 mins
Victoria sandwich (2 x 180mm / 7")	160	1	20 - 25 mins
Swiss roll	200	1	8 - 12 mins
Semi rich fruit cake (180mm x 7")	140	1	2¼ - 2¾ hours
Scones	215	1	10 - 15 mins
Meringues	90 - 100	1	2 - 3 hours
Shortcrust pastry	200 - 210	1	Depends on size & type of cooking dish & also the filling
Puff / flaky pastry	200 - 210	1	
Choux pasrty	200 - 210	1	
Biscuits	160 - 200	2	10 - 20 mins
Sponge pudding	150	1	30 - 45 mins
Milk pudding	140	1	2 - 2½ hours

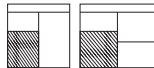

## USING THE OVEN/GRILL - MULTI-FUNCTION

### MULTIFUNCTION OVEN

The multifunction oven can be controlled by the programmer (see The Programmer/Clock for details).

The programmer, must be set to manual before it can be used, or programmed.

### Switching on the multifunction oven

- Use the function control knob to select the function you wish to use - see the functions table for details.  
Note: You can change function during cooking if you wish, as long as the oven is in manual mode.
- Turn the temperature control knob to the temperature you wish to use.
- The thermostat indicator will come on to show that the oven is heating, and once the temperature is achieved, it will go out.
- To switch off the oven, simply turn the control knob back to the '•' position.
- The cooling fan may come on during use, and may continue to run for some time afterwards.



**Important:** Never place food, or dishes on the base of the main oven, the element is here and it will cause over heating.

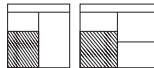

# USING THE OVEN/GRILL - MULTI-FUNCTION

## Oven & Grill Functions

The chart below details all of the functions which are available. Your oven may not have all of the functions shown here.

Main Oven Function		Recommended Uses
	Base Heat Only	Used to finish off the bases of food following cooking using the conventional or fanned modes. The base heat can be used to provide additional browning for pizzas, pies and quiche. Use this function towards the end of cooking.
	Top Heat Only	The heat is ideal from browning off the tops of food as it is not as fierce as the grill following conventional or fanned cooking. Provides additional browning for dishes like Lasagna or Cauliflower cheese. Use this function towards the end of cooking.
	Conventional Oven	This function is ideal for traditional roasting. The meat is placed in the middle of the oven, roast potatoes towards the top.
	Intensive Bake	Suitable for food with a high moisture content, such as quiche, bread and cheesecake. It also eliminates the need for baking pastry blind.
	Fanned Grill	The fan allows the heat to circulate around the food. Ideal for thinner foods such as bacon, fish and gammon steaks. Foods do not require turning. Use with the oven door closed.
	Fanned Oven	The even temperature in the oven makes this function suitable for batch baking, or batch cooking foods.
	Defrost	To defrost foods, such as cream cakes/gateaux, use with the oven door closed. For cooling dishes prior to refrigeration, leave the door open.
	Dual Grill	This function cooks food from the top and is ideal for a range of food from toast to steaks. As the whole grill is working, you can cook larger quantities of food.
	Single Grill	For smaller quantities of food, but is still ideal for anything from toast to steaks.
	Base Heat with Fan	Used to cook open pies (such as mince pies) the base element ensures that the base is cooked while the fan allows the air to circulate around the filling - without being too intensive.
	Bread Proving	This function circulates air at the correct temperature for proving bread dough before baking for up to 40°C.
	Pizza	This function is ideal for cooking pizza. The fanned oven operates with the addition of the base element to cook pizza perfectly

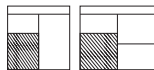

## USING THE OVEN/GRILL - MULTI-FUNCTION

### Before you start grilling. . . .

Before you use the grill, make sure you have placed the grill shelf in the position you need as once the grill is on you may injure yourself if you try to move the shelf.

### FANNED / CONVENTIONAL GRILL

- The grill function must be used with the door closed.
- Turn the selector control knob to the grill setting you require (conventional or fanned).
- Turn the temperature selector to the heat setting you require in a similar way to selecting the oven temperature.

To switch off, return the control knobs to the 'off' position.

The cooling fan may come on during use, and may continue to run for some time afterwards.

To adjust your results, you can turn the grid over, or remove it altogether.

### The grill neon

When grilling with the door closed, the neon will cycle on and off as the temperature is maintained inside the cavity.

**i** **Warning:** Accessible parts may become hot when the grill is in use. Children should be kept away.

### **i** Types of grill

Single grill: has one grill element. The grill pan trivet **MUST** be inverted when using single grill in the main oven.

**i** For best results:  
Pre-heat the single grill for 5 minutes and the dual grill for 3 minutes.

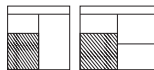

## USING THE OVEN/GRILL - MULTI-FUNCTION

### Fanned oven guide

- Some adjustment will have to be made to conventional cooking temperatures.
- The table below shows conventional cooking temperatures, fanned temperatures and gas marks. For optimum results using the fanned oven setting, conventional temperatures need to be converted to the fanned oven temperatures.
- For example an item which would cook at 180°C will now cook at the fanned oven temperature of 160°C.
- This is a high efficiency oven, you may notice an emission of steam when the door is opened.
- When cooking chilled or frozen foods, use the recommended cooking times and temperature on the packaging. Always make sure the food is piping hot throughout before serving.
- There are no zones of heat, and no flavour transfer when using a fanned oven - allowing you to cook a greater variety of foods together.
- If you are cooking on more than one shelf, you may need to slightly increase the cooking time.
- Always make sure that there is enough space between dishes, to allow food to rise, and to air to circulate.

Conventional temp (°C)	'A' Efficiency oven (°C)	Gas Mark
100	100	1/4
110	110	1/4
130	120	1/2
140	130	1
150	140	2
160	150	3
180 - 190	160	4 - 5
200	170	6
220	180	7
230	190	8
250	200	9

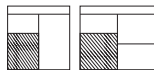

# USING THE OVEN/GRILL - MULTI-FUNCTION

## COOKING GUIDE

### Pre-heating

To get the best results from your oven, we recommend pre-heating for around 5 to 15 minutes before placing your dishes in. This is especially important for items which are chilled, frozen, batter based, yeast based or whisked sponges.

If you are using a fanned function, you should still preheat but for a shorter time.

The items in the cooking guide below are based on a pre-heated oven, but can be adjusted to take into account personal taste.

### Oven and bake-ware

Always use high quality trays and tins for cooking. Poor quality tins and trays can warp in the oven producing uneven results.

Never use dishes which are cracked, damaged or not oven proof as heating may lead to shattering inside the oven.

## OVEN FURNITURE

### Oven shelves

The oven shelf must be positioned with the upstand at the rear of the oven and facing upwards.

Position baking trays and roasting tins on the middle of the shelves, and leave one clear shelf position between shelves, to allow for circulation of heat.

### Baking tray and roasting tins



For best cooked results and even browning, the recommended size baking trays and roasting tins that should be used are as follows;

Baking tray 350mm x 250mm

This size of baking tray will hold up to 12 small cakes.

Roasting tin 370mm x 320mm

We recommend that you use good quality cookware. Poor quality trays and tins may warp when heated, leading to uneven baking results.

Food Type	Temp. Setting °C			Time Approx.	Shelf Position
	Conv 	Fanned 	Intensive 		
<b>Cakes</b>					
Small cakes	190	175	-	15 - 25	2 & 4
Victoria sandwich	180	160	-	20 - 30	3
Semi rich fruit cake	150	125	-	2½ - 3hrs	2
Christmas cake	150	125	-	2½ - 3hrs	2
<b>Puddings</b>					
Bread & butter pudding	170	150	-	45 - 1hr	3
Fruit crumble	200	175	-	40 - 1hr	3
<b>Miscellaneous</b>					
Yorkshire pudding: large	220	200	200	40 - 45	4 - 5
small	220	200	200	15 - 20	4 - 5
Shortcrust pastry	200	180	180	depends on filling	4 - 5

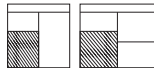

## USING THE OVEN/GRILL - MULTI-FUNCTION

### Roasting Guide

- Roasting times depend on the weight, shape and texture of the meat and personal preference. In order to calculate the roasting time, weigh the meat or poultry, including the stuffing, and follow the times given below.

Meat joints (including chicken) should be roasted at 180 - 200°C Conventional/ 160 - 180°C Fanned for 20 - 30 mins per 450g/1lb, plus 20 minutes on shelf position 2.

- Use of a trivet with the roasting tin will reduce fat splashing during open roasting, and will help to keep the oven interior clean.
  - The use of a roasting tin larger than that supplied is not advised, as this may impair performance and lead to extended cooking times.
- Frozen meat must be thoroughly thawed before cooking. For large joints, it is advisable to thaw overnight.
  - Frozen poultry must be thoroughly thawed before cooking. The time required depends on the size of the bird - eg: a large turkey may take up to 48 hours to thaw.
  - When cooking stuffed meat or poultry, calculate the cooking time from the total weight of the meat plus the stuffing.
  - Cooking joints in foil, covered roasters, lidded casseroles, or roasting bags will help to reduce meat shrinkage, give a more moist result and may reduce fat splashing. However, a slightly longer cooking times will be required, add 5 - 10 minutes per 450g (1lb) to the calculated cooking time. When using roasting bags do not exceed the temperatures recommended by the manufacturer, and do not allow the roasting bag to touch the sides or top of the oven.

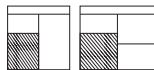

## USING THE OVEN/GRILL - MULTI-FUNCTION

### Roasting Guide

#### Roast turkey

- Roasting turkey perfectly involves cooking two different types of meat - the delicate light breast meat, which must not be allowed to dry out, and the darker leg meat, which takes longer to cook.
- The turkey must be roasted long enough for the legs to cook, so frequent basting is necessary. The breast meat can be covered once browned.
- Turkey should be roasted at 180°C - 190°C Conventional / 160°C - 180°C Fanned for 20 mins per 1lb, plus 20 minutes.
- The turkey can be open roasted, breast side down, for half of the cook time, and then turned over for the remainder of the cooking time.
- If the turkey is stuffed, add 5 minutes per 1lb to the cooking time.
- If roasting turkey covered with foil, add 5 minutes per 1lb to the cooking time.
- To test if the turkey is cooked, push a fine skewer into the thickest part of the thigh. If the juices run clear, the turkey is cooked. If the juices are still pink, the turkey will need longer cooking. Always make sure that the turkey is cooked properly before serving.

#### Turkey Roasting times.

Most Turkeys are measured by the kilogram. Timing should be calculated in either of these ways:

40 minutes per 1kg plus 10 minutes per 1/4 kg.

or

20 minutes per 1lb, plus 20 minutes.

The maximum size Turkey for this appliance is: 20lbs approximately 9kgs.

Please do not attempt to roast a Turkey larger than this, as the results cannot be guaranteed.



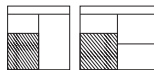

# USING THE OVEN/GRILL - MULTI-FUNCTION

## General Baking Guide

### Trouble-shooting - fruit cakes

PROBLEM	POSSIBLE CAUSE
Fruit sinking to the bottom	Low oven temperature which may cause the cake to take longer to set, allowing the fruit to sink. Or, too much liquid, or raising agent. The fruit may not have been properly washed and dried.
Cake sinking / dipping in the centre	Too much raising agent in the mixture. Too hot, or too cool an oven. Or, not enough liquid or insufficient creaming.
Surface cracks	Too small a tin, or too much mixture in the tin. Too much raising agent in the mix, plus not enough liquid or insufficient creaming. The oven may be too hot.
Hard outer crust with a damp patch inside	Oven too hot, therefore the cake baked too quickly. Too much sugar, or insufficient liquid.
Burnt outside	Oven temperature too high. Oven too small for the size of cake. Insufficient protection around the tin. Cake baked on too high a shelf.
Texture with pronounced holes.	Too much raising agent. Flour unevenly mixed.
Texture too close and cake insufficiently risen.	Not enough raising agent. Not enough liquid. Too cool an oven. Insufficient creaming.
Cake crumbles when cut	Not enough liquid. Baked for too long. Not enough sugar. Too much baking agent.
Too dry	Over baking. Insufficient egg or liquid. Too much raising agent.

### Trouble-shooting - sponge cakes

Domed top	Insufficient creaming of mixture. Cake baked on too high a shelf position, or at too high a temperature. Paper liners can cause the outer edge not to rise and the centre to peak.
Hollowed / sunken top	Too much raising agent. Oven temperature too low, or incorrect shelf position. Cake removed from oven before it's cooked. Use of soft tub margarine.
Very pale, but cooked	Oven temperature too low. Baked too low in the oven
Overflowing tin	Tin too small for the amount of mixture

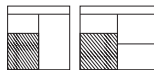

# USING THE OVEN/GRILL - MULTI-FUNCTION

---

## Cooling and Defrosting Function

- To cool foods quickly straight after cooking, but before refrigerating or freezing, turn the oven control to the defrost position, and open the door.
- To defrost frozen foods, turn the oven control to the defrost position, place the food in the centre of the oven and close the door.

## Defrosting times

- Small or thin pieces of frozen fish or meat - eg; fish fillets, prawns, and mince will take approximately 1 - 2 hours. Placing the food in a single layer will reduce the thawing time.
- A medium sized casserole or stew will take around 3 - 4 hours.
- A 1½kg / 3lb oven ready chicken will take around 5 hours, remove the giblets as soon as possible.
- Always check foods are thoroughly defrosted before cooking.

## Be safe

- Do not defrost stuffed poultry using this method.
- Do not defrost larger joints of meat and poultry over 2kg / 4lb using this method.
- Never place uncooked food for defrosting next to cooked food which is to be cooled, as this can lead to cross contamination.
- Defrosting meat, poultry and fish speeded up using this method, but make sure they are completely thawed before cooking thoroughly.
- Place meat and poultry on a trivet in a meat tin, to catch the juices from the defrosting process.

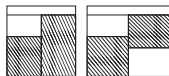

## USING THE MAIN OVEN - ELECTRIC

---

**Accessible parts may be hot when the oven is used. Young children should be kept away.**

### **To switch on the oven**

Turn the oven control knob(s) to the required setting.

The white thermostat neon (if fitted) will come on until the selected temperature is reached and then go off; it will turn on and off periodically as the thermostat operates to maintain the selected temperature.

To switch off, return the control knob to the off ● position.

### **When using the oven**

As part of the cooking process, hot air is expelled through a vent in the oven. When opening the oven door, care should be taken to avoid any possible contact with potentially hot air, since this may cause discomfort to people with sensitive skin. We recommend that you hold the underneath of the oven door handle.

## **PREHEATING**

### **Fanned oven**

When cooking sensitive items such as soufflé and Yorkshire puddings or, when cooking bread, we recommend that the oven is preheated until the neon switches off for the first time. For any other types of cooking, a preheat may not be required.

### **Conventional oven**

Preheating is always required

### **Manual Operation (Left hand oven only)**

The programmer must be set to manual operation before the main oven can be used. If A (Auto) is on the programmer display, return the oven to manual by pressing the up and down buttons simultaneously. Any programme which has been set is cancelled.

### **The cooling fan**

The cooling fan may operate when the main oven is on and may continue to operate for a period after the oven has been switched off.

## **OVEN FURNITURE**

### **Oven shelves**

The oven shelf must be positioned with the upstand at the rear of the oven and facing upwards.

Position baking trays and roasting tins on the middle of the shelves.

### **Baking tray and roasting tins**

For best cooked results and even browning, the recommended size baking trays and roasting tins that should be used are as follows;

Baking tray 350mm x 250mm

This size of baking tray will hold up to 12 small cakes.

Roasting tin 370mm x 320mm

We recommend that you use good quality cookware. Poor quality trays and tins may warp when heated, leading to uneven baking results.

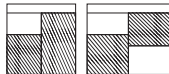

## USING THE MAIN OVEN - ELECTRIC

### Slow cooking (S Setting or 100°C)

- Make sure that frozen foods are thoroughly thawed before cooking.
- Do not slow cook joints of meat or poultry weighing more than 2¼kg/4½lb.
- Preheat the oven to 170°C and cook for 30 minutes, then adjust the oven control to S or 100°C (slow cook setting) for the remainder of the cooking time.
- Slow cooking times will be about 3 times as long as conventional cooking times.
- Do not open the oven door unnecessarily during slow cooking, as this will result in heat loss at low temperatures.
- Always use dishes with tightly fitting lids. To rectify badly fitting lids, place foil over the dish underneath the lid.

### Aluminium foil

Use foil only to cover food or cooking dishes, using foil to cover the shelves or oven base creates a fire hazard.

### Cooking with a fanned oven

**As this is a high efficiency oven, you may notice the emission of steam from the oven when the door is opened. Please take care when opening the door.**

If you are used to cooking with a conventional oven you will find a number of differences to cooking with a fan oven which will require a different approach:

There are no zones of heat in a fan oven as the convection fan at the back of the oven ensures an even temperature throughout the oven.

This makes it ideal for batch baking - eg; when planning a party as all the items will be cooked within the same length of time.

Foods are cooked at a lower temperature than a conventional oven, so conventional recipe temperature may have to be reduced. Please refer to the conversion chart.

Preheating is generally not necessary as a fan oven warms up quickly.

There is no flavour transference in a fan oven, which means you can cook strong smelling foods such as fish at the same time as mild foods - eg; milk puddings.

When batch baking foods that will rise during cooking - eg; bread - always ensure that enough space has been left between the shelves to allow for the rise.

### Notes:

When 2 or more shelves are being used, it may be necessary to increase the cooking time slightly.

Because the 2 oven shelves are wider than in many ovens, it is possible to cook 2 items per shelf - eg; 2 victoria sandwiches or 2 casseroles.

Although you need to keep in mind the points 'To help the air circulate freely' with careful choice of dishes and tins, it is possible to cook a complete meal, and perhaps something else for the freezer, in the oven at the same time.

When roasting meats, you will notice that fat splashing is reduced, which is due in part to the lower oven temperatures, and will help keep cleaning of the oven to a minimum.

Because a fan oven has an even temperature throughout the oven, there is no need to follow the shelf positions given in the baking guide.

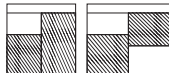

## USING THE MAIN OVEN - ELECTRIC

---

There is no need to interchange dishes onto different shelves part way through cooking, as with a conventional oven.

### To help the air circulate freely

Position the shelves evenly within the oven and maintain a clearance from the oven roof and base.

If more than one cooking dish or baking tray is to be used on a shelf, leave a gap of at least 25mm between the items themselves and the oven interior.

### Keep Warm (Setting or 70°C)

This setting temperature is set to allow the user to keep food warm without over cooking. This setting can also thaw frozen foods, or warm plates.

Do not use this as a cooking function.

### Defrosting and cooling in the main oven

To defrost frozen foods, turn the main oven control to the Bread Proving position, place the food in the centre of the oven and close the door.

To cool foods after cooking prior to refrigerating or freezing, turn the main oven control to the defrost position and open the door.

### Defrosting times

Small or thin pieces of frozen fish or meat - eg; fish filets, prawns & mince will take approximately 1 - 2 hours.

Placing the food in a single layer will reduce the thawing time.

A medium sized casserole or stew will take approximately 3 - 4 hours.

A 1½kg/3lb oven ready chicken will take approximately 5 hours, remove the giblets as soon as possible.

### Be safe

Do not defrost stuffed poultry using this method.

Do not defrost larger joints of meat and poultry over 2kg/4lb using this method.

Never place uncooked food for defrosting next to cooked food which is to be cooled, as this can lead to cross contamination.

Defrosting meat, poultry, and fish can be accelerated using this method but make sure they are completely thawed before cooking thoroughly. Place meat and poultry on a trivet in a meat tin.

## MAIN OVEN BAKING GUIDE

### Cooking times & temperatures

The temperature settings and times given in the baking guide are based on dishes made with block margarine. If soft tub margarine is used it may be necessary to reduce the temperature setting.

Allow enough space between shelves for food that will rise during cooking.

Do not place items on the oven base as this will prevent air circulating freely.

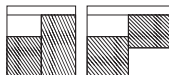



## USING THE MAIN OVEN - ELECTRIC

Note: This is a fanned oven, therefore some adjustment will have to be made to conventional cooking temperatures. The table below shows conventional cooking temperatures, fanned oven temperatures and gas marks. For optimum results,

conventional temperatures need to be converted to fanned oven temperatures.

For example, an item which would normally cook at a conventional temperature of 180 °C, will now cook at the fanned oven temperature of 160°C.

Conventional temperature (°C)	Fanned Oven (°C)	Gas Mark
100	100	1/4
110	110	1/4
130	120	1/2
140	130	1
150	140	2
160	150	3
180-190	160	4-5
200	170	6
220	180	7
230	190	8
250	200	9

Food Type	Temperature settings (°C)		Time Approx.	Shelf Position
	Conv 	Fanned 		
Cakes				
Small cakes	190	160	15 - 25	2 - 4
Victoria sandwich	180	160	20 - 30	3
Semi rich fruit cake	150	125	2.5HRS - 3HRS	2
Christmas cake	150	125	2.5HRS - 3HRS	2
Puddings				
Bread and butter pudding	170	150	45 - 1hr	3
Fruit crumble	200	175	40 - 1hr	3
Miscellaneous				
Yorkshire pudding: large	220	200	40 - 48	4 - 5
small	220	200	15 - 20	4 - 5
Shortcrust pastry	200	180	Depends on filling	4 - 5

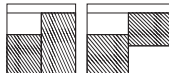

## USING THE MAIN OVEN - ELECTRIC

---

### Traditional fruit cakes

It should be remembered that ovens can vary over time, therefore cooking times can vary, making it difficult to be precise when baking fruit cakes.

It is necessary therefore, to test the cake before removal from the oven. Use a fine warmed skewer inserted into the centre of the cake. If the skewer comes out clean, then the cake is cooked.

- Follow the temperatures suggested in the recipe and then adjust accordingly to the conversion table.
- Do not attempt to make Christmas cakes larger than the oven can cope with, you should allow at least 25mm (1") space between the oven walls and the tin.
- Always follow the temperatures recommended in the recipe.
- To protect a very rich fruit cake during cooking, tie 2 layers of brown paper around the tin.
- We recommend that the cake tin is not stood on layers of brown paper, as this can hinder effective circulation of air.
- Do not use soft tub margarine for rich fruit cakes, unless specified in the recipe.
- Always use the correct size and shape of tin for the recipe quantities.

### Roast turkey

Roasting turkey involves cooking two different types of meat - the delicate light breast meat, which must not be allowed to dry out, and the darker leg meat, which takes longer to cook.

The turkey must be roasted long enough for the legs to cook, so frequent basting is necessary. The breast meat can be covered once browned.

- Always make sure that the turkey is completely thawed and that the giblets are removed before cooking.
- Turkey should be roasted at 160°C - 180°C (fanned) or 180°C - 200°C (conventional) for 20 minutes per 450g (1 lb), plus 20 minutes, unless packaging advises otherwise.
- The turkey can be open roasted, breast side down, for half of the cook time, and then turned over for the remainder of the cooking time.
- If the turkey is stuffed, add 5 minutes per 450g (1 lb) to the cooking time.
- If roasting turkey covered with foil, add 5 minutes per 450g (1 lb) to the cooking time.

To test if the turkey is cooked, push a fine skewer into the thickest part of the thigh. If the juices run clear, the turkey is cooked. If the juices are still pink, the turkey will need longer cooking.

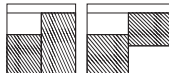

## USING THE MAIN OVEN - ELECTRIC

### Roasting guide

The times given in the roasting guide are only approximate, because the size and age of the bird will influence cooking times as will the shape of a joint and the proportion of the bone.

Frozen meat should be thoroughly thawed before cooking. For large joints it is advisable to thaw over night.

Frozen poultry should be thoroughly thawed before cooking. The time required depends on the size of the bird - eg; a large turkey may take up to 48 hours to thaw.

Use of a trivet with a roasting tin will reduce fat splashing and will help to keep the oven interior clean. Alternatively, to help reduce fat splashing, potatoes or other vegetables can be roasted around the meat/poultry.

### Notes:

- When cooking stuffed meat or poultry calculate the cooking time from the total weight of the meat plus the stuffing.
- For joints cooked in foil or covered roasters, and for lidded casseroles, add 5 minutes per 450g (1lb) to the calculated cooking time.
- Smaller joints weighing less than 1.25kg (2½lb) may require 5 minutes per 450g (1lb) extra cooking time.
- Position the oven shelf so that the meat or poultry is in the centre of the oven.
- It is recommended that the appliance is cleaned after open roasting.

<b>Cook in main oven at:</b> <b>160°C - 180°C (fanned)</b> <b>180°C - 200°C (conventional)</b>		<b>Approximate Cooking Time</b> <b>(preheated oven)</b>
<b>Beef</b>	Rare Medium Well done	20 minutes per 450g (1lb), plus 20 minutes 25 minutes per 450g (1lb), plus 25 minutes 30 minutes per 450g (1lb), plus 30 minutes
<b>Lamb</b>	Medium Well Done	25 minutes per 450g (1lb), plus 25 minutes 30 minutes per 450g (1lb), plus 30 minutes
<b>Pork</b>		35 minutes per 450g (1lb), plus 35 minutes
<b>Poultry</b>		20 minutes per 450g (1lb), plus 20 minutes





# USING THE OVEN - SLOW COOK (100/110CM ONLY)

---

## Introduction

One of your oven compartments is an electric oven which provides a gentle heat suitable for slow cooking or keeping food warm. The oven is operated by a button at the right hand of the fascia, and a white neon will illuminate to show that the oven is switched on. Please check which side the slow cook oven is on, by looking at the specification at the front of this handbook.

The slow cook element is positioned in the base of the lower compartment- always make sure that the prepared cooking pot is placed centrally on the base of this compartment.

Do not use either compartment to store food or canned items.

Do not use the upper compartment for slow cooking, or food warming.

## Cooking times

The cooking time varies according to the type of food being cooked, and experience will show how long foods should be cooked for, according to personal taste and preference.

In general foods should be cooked for at least 5 hours, and maybe left up to 8-10 hours without spoiling if covered. As a guide, foods cooked using the slow cook oven will take about three times longer than they would in a conventional oven.

## Cookware

Any oven proof cookware maybe used for slow cooking, provided they have a close fitted lid.

To rectify a badly fitting lid a piece of cooking foil may be placed over the dish, under the lid.

For convenience and to save washing up, the most useful cookware for slow

cooking are the flame proof type which can be used over direct heat and for oven cooking, and are sufficiently attractive to use as serving dishes.

## Keeping food warm

Turn the oven on, and allow to pre-heat for 20 minutes before placing the food in the oven. If food is to be kept moist then it is important to cover the dish or plate to prevent food from drying out. This can be done using aluminium foil if the dish does not have a lid.

Do not use cling film to cover food as it cannot with stand the heat produced in the oven.

Some foods are best left un covered if you wish to keep the food dry and crisp.

Do not add gravy to plated meals until serving.

Carved meat should be placed on one plate and covered, adding just one tablespoon of gravy to keep it moist. When keeping plated meals warm it is recommended that the food is placed on hot rather than cold plates.

## Slow Cooking

Slow cooking has always been the best way to prepare a nutritious hot meal with the minimum of preparation and maximum time away from the kitchen. The benefits of slow cooking have been recognized by cooks for centuries, and are still appreciated by cooks today.



## USING THE OVEN - SLOW COOK (100/110CM ONLY)

---

### **The advantages of slow cooking are as follows:**

- Food can be left to cook unattended for several hours and will keep hot for several hours if left covered, without spoiling for a further 2-3 hours, so foods can be left to cook while you are out for the day, or over night.
- Inexpensive cuts of meat become deliciously tender when slow cooked.
- Slow cooking will also produce moist, tender "roasts" with minimal meat shrink-age and reduced oven soiling.
- Dishes such as soups, vegetables, puddings savory dishes and preserves are also suitable for slow cooking.
- There is no topping up of steamers, steam filled kitchens or constant checking to do.
- Make sure all frozen ingredients are well thawed out.
- Always ensure that frozen poultry has thoroughly defrosted in a refrigerator and all ice crystals have melted.
- Cut root vegetables into smaller pieces as they take longer than meat to cook.
- If possible they should be sauteed for 2-3 minutes before slow cooking.
- Ensure that root vegetables are always at the bottom of the pan immersed in the cooking liquid.
- A meat thermometer should be used when cooking pork joints and poultry. The internal temperature of the food should reach 88 °C,
- Stuffed meat or stuffed poultry should not be slow cooked. Cook any stuffing separately.

### **Using the slow cook oven**

Turn the oven on and preheat for 20 minutes. Always place the prepared cooking pot centrally on the base of the oven. Follow the guide lines for the best results.

- The maximum capacity of oven proof dishes should be no more than 2.5 litres (4.5 pints).
- Please note: The more you fill the dish/pot the longer it will take to cook.
- Cooking times will vary depending on the size and shape of the meat, or poultry.
- Always bring soups, casseroles and liquids to the boil before placing in a preheated oven. To give more colour to meat or poultry, fry the meat to brown and add to stock which is hot.
- All meat and poultry recipes need a minimum of 5 hours to cook.
- Cover casseroles with a lid, or foil to prevent loss of moisture.
- Adjust seasonings and thickenings at the end of cooking time.
- Dried red kidney beans must be boiled for a minimum of 10 minutes following soaking before inclusion in any dish.
- Opening the door during cooking, leads to heat loss, and will lead to increased cooking times.

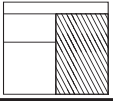

## USING THE SPLITTER - 90CM DELUXE ONLY

With the Stoves **PROFLEX™** splitter you can convert the tall oven into two separate fan ovens which can be controlled independently to maximise your cooking options.

### Left hand control

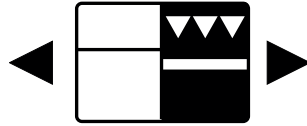
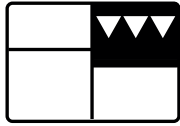

### Right hand control

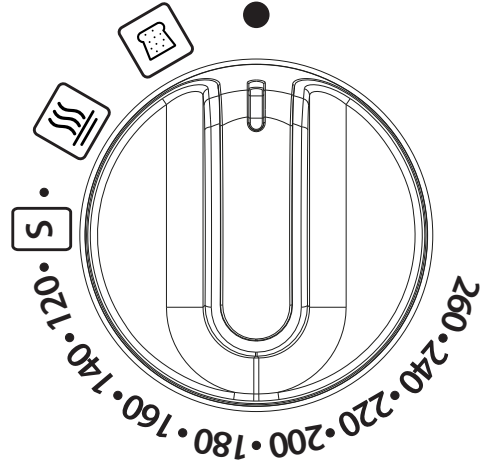
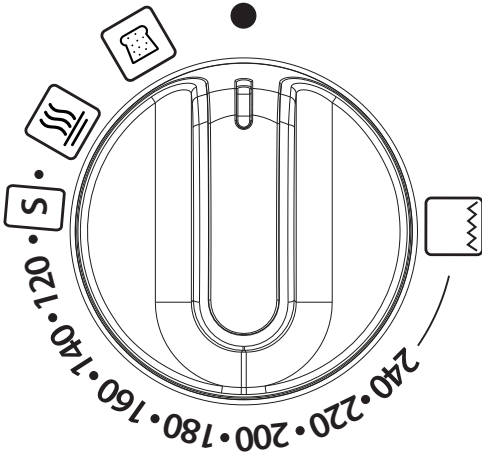

## To activate the Tall Oven (without splitter)

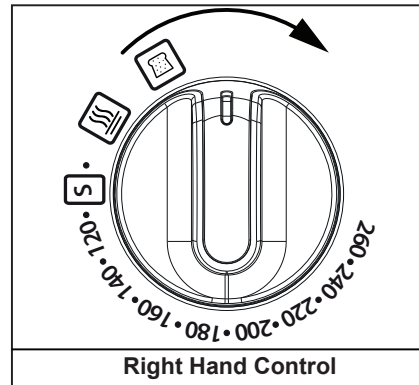
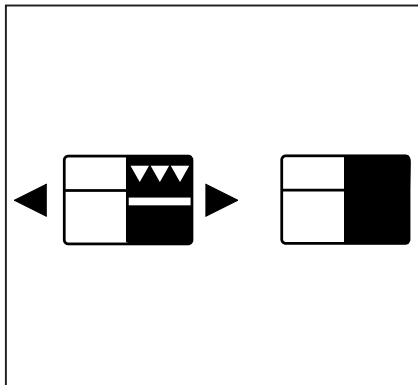

To use the tall oven without the splitter, turn the right hand control knob to the desired function or temperature.

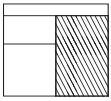

## USING THE SPLITTER - 90CM DELUXE ONLY

### To activate the splitter function

#### Upper Oven (with splitter)

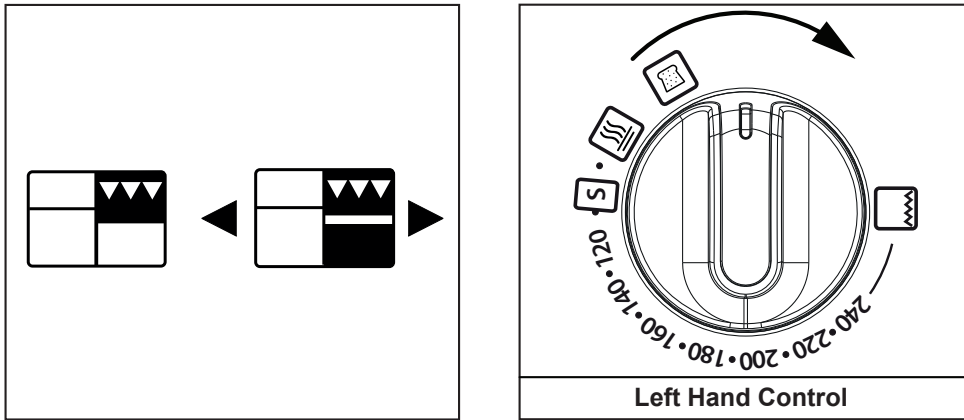

To use the upper oven separately, firstly insert the splitter then turn the left hand control knob to select the function or temperature. This will activate the top half of the oven.

Please do not use the splitter as a shelf and only position into the dedicated guides in the tall cavity.

#### Lower Oven (with splitter)

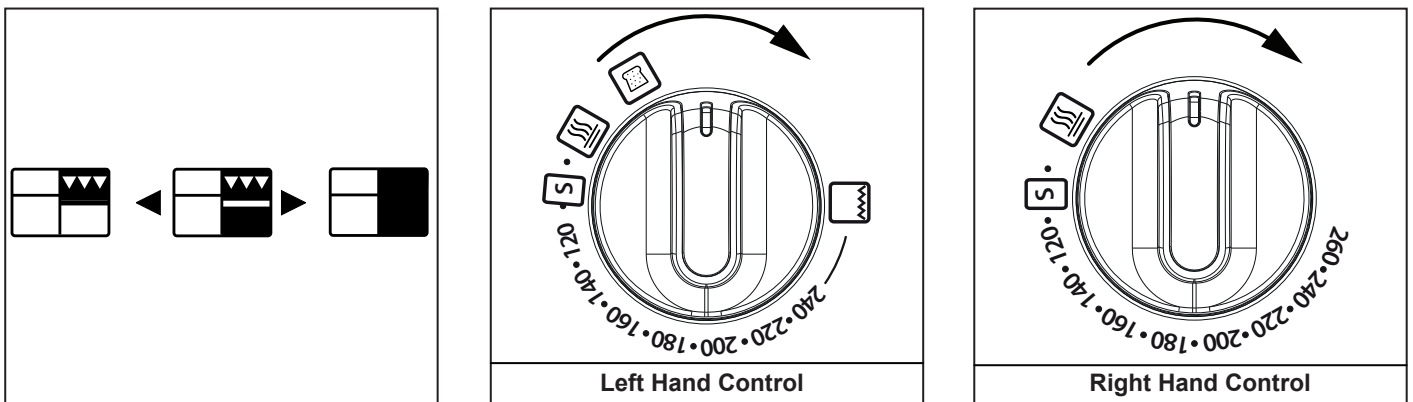

With the upper oven activated, by turning the right hand control knob to a function or temperature, the lower oven can operate. The lower oven cannot be used separately.

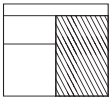

**Warning:** Please be aware that that splitter will get very hot.



# USING THE SPLITTER - 90CM DELUXE ONLY

## Using the upper and lower ovens

When using the upper and lower ovens at different temperatures, use the upper oven at the higher temperature and the lower oven at the lower temperature. The table below shows the minimum temperature that can be achieved in the lower oven when the upper oven is in use. For example with the upper oven at 200°C, the minimum temperature that can be used in the lower oven is 120°C.

Upper Oven temperature (°C)	Lower Oven Minimum temperature (°C)
100 (Slow Cook) 	70 (Keep Warm) 
120	80
140	90
160	100 (Slow Cook) 
180	110
200	120
220	130

## Grilling

THE DOOR **MUST** BE OPEN WHEN THE GRILL IS USED FOR CONVENTIONAL GRILLING.

To operate the grill, turn the left hand control to the grill function symbol.

### Grill pan and trivet

The grill trivet (inside the grill pan) can be inverted to give a high or low position, or it may be removed. The speed of grilling can be controlled by selecting a higher or lower shelf position, or adjusting the grill setting.

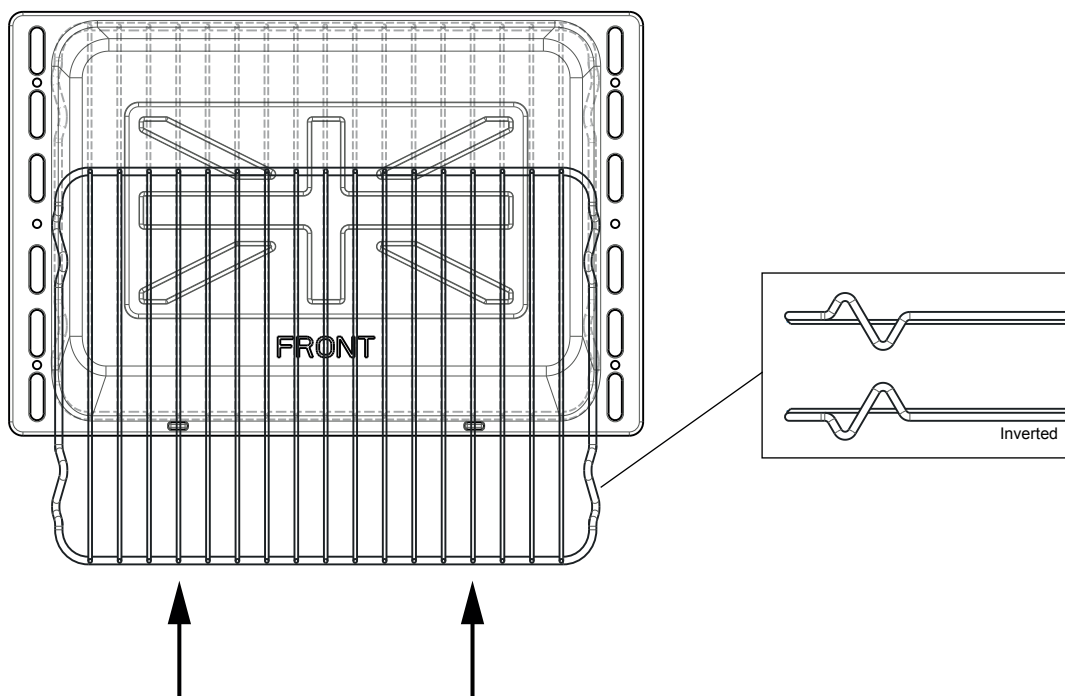

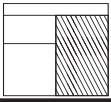

## USING THE SPLITTER - 90CM DELUXE ONLY

### How to position the Splitter

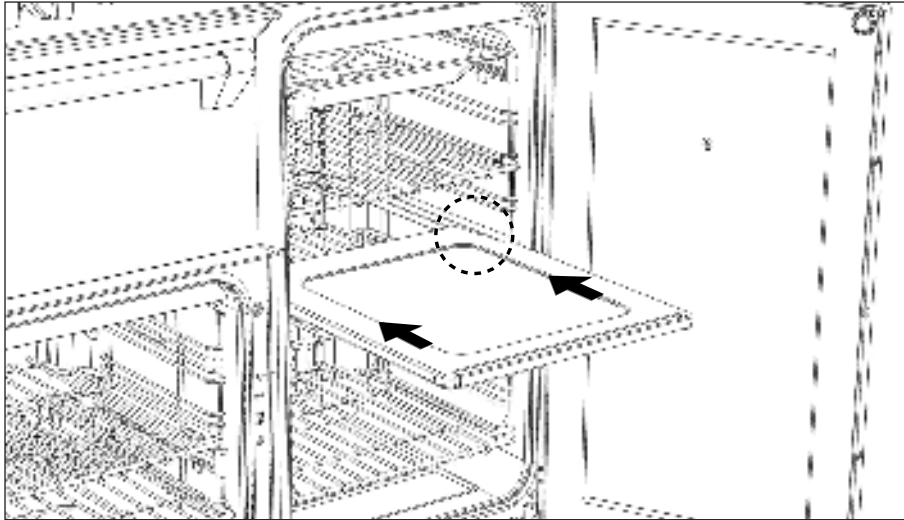





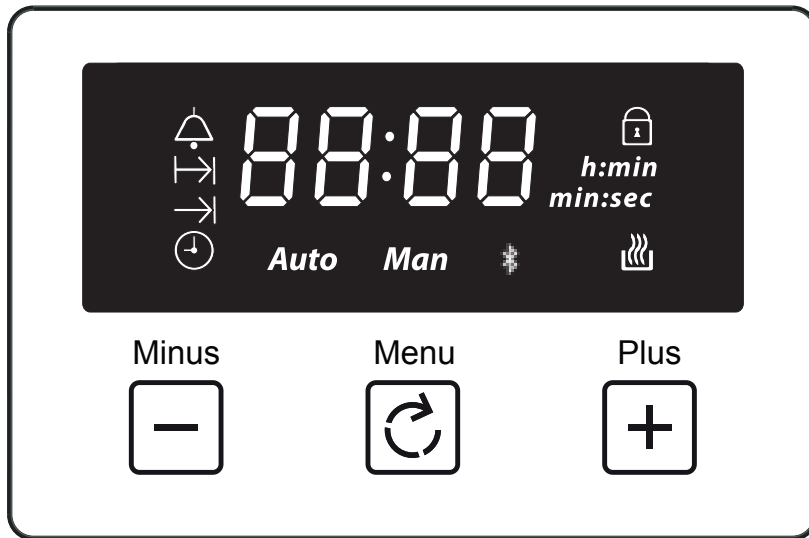

# CLOCK/PROGRAMMER - STOVES RICHMOND

Please be aware that only the multifunction oven is controlled by the programmer.

**Note:** Your clock / programmer may not have all these functions



	Minute minder	<b>Man</b>	Manual mode
	Cooking time / Duration	L 1, L 2, L 3	Volume level
	End of cooking time	23:59	7-segment display
	Time of day	99:00	Max. adjustable minute minder
	Keylock	23:59	Max. adjustable cooking time
	Auto cooking	<b>h:min</b>	Display hours:minutes
<b>Auto</b>	Automatic mode	<b>min:sec</b>	Display minutes:seconds
	Bluetooth Connectivity		

(Deluxe models only)

## Using the touch controls

Menu - Scroll through to select a function

Plus - Increase time or volume

Minus - Decrease time or volume

When a function is selected and the time or volume is set, the chosen function will automatically start seven seconds after setting.

## Manual Mode

If the programmer is not in semi-automatic or full-automatic mode you can use oven functions manually. The manual icon is also on the display.

# CLOCK/PROGRAMMER - STOVES RICHMOND

## Setting the time of day

By pressing menu, scroll through the functions until you reach 'time of day'.

- 1 Press the function button until the 'time of day' symbol appears

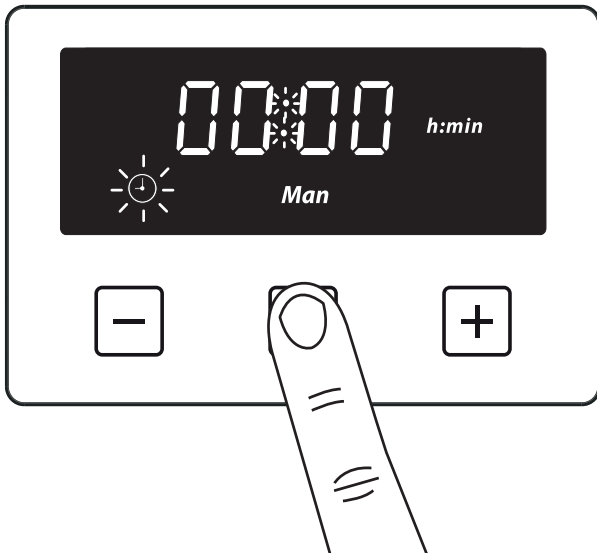

- 2 Press the plus or minus buttons to set a time

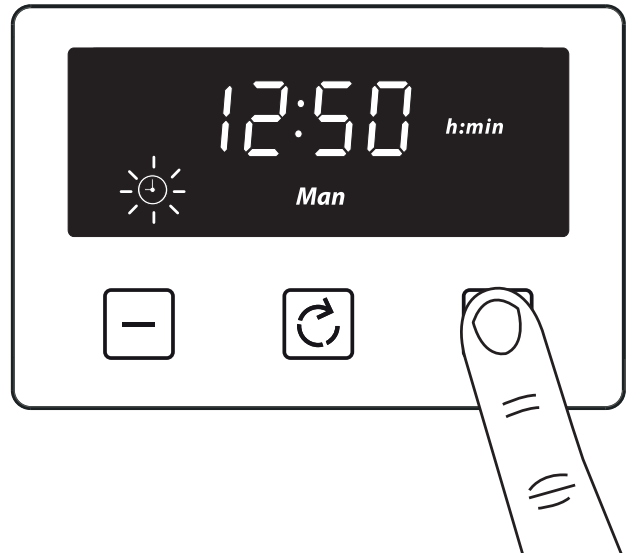

## Setting the minute minder

The maximum cooking time that can be set is 99 minutes.

- 1 Press the function button until the 'minute minder' symbol appears

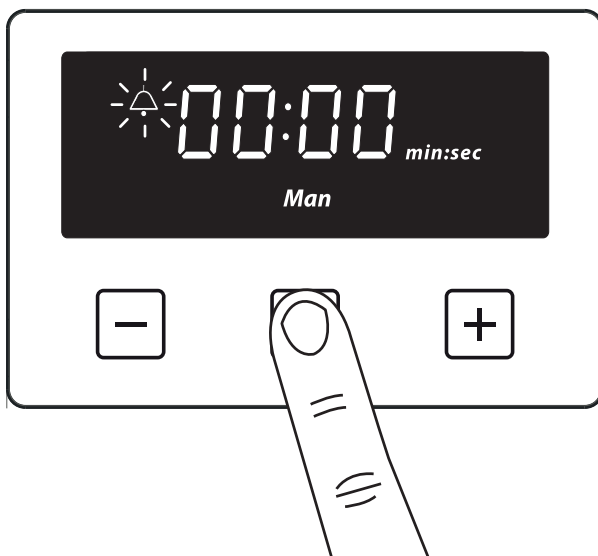

- 2 Press the plus or minus buttons to set a time

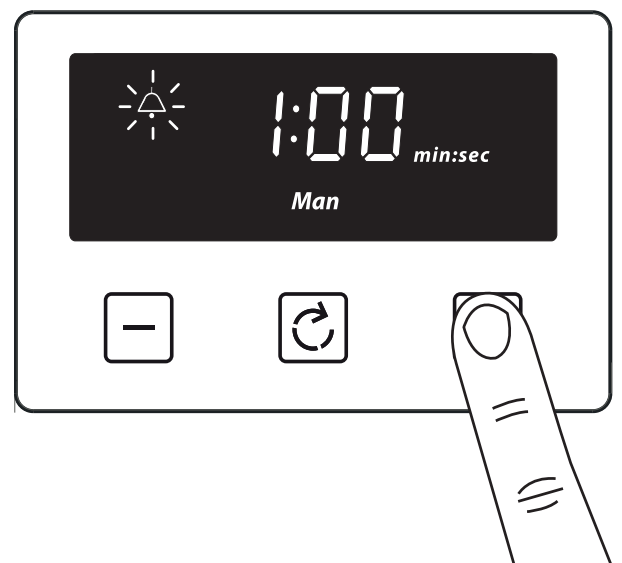

Once set, the minute minder will start to countdown in steps of seconds. The display will show the minute minder symbol and the remaining time. The countdown will continue in the background, if other functions are being set.

When the set time for the minute minder has completed, an alarm is heard and the minute minder symbol will flash on the display. Press any button to stop the alarm and the time of day is displayed.



# CLOCK/PROGRAMMER - STOVES RICHMOND

## To modify or cancel the minute minder

Return to the minute minder function and use either the plus or minus buttons to adjust the time. By setting the time to '0.00', this will cancel the countdown.

## Setting the cooking time (the duration of time the oven will operate for) Semi Automatic cooking

**Note:** Only the bottom left hand oven on 1000cm and 1100cm appliances can use the Semi Automatic cooking function.

The maximum cooking time that can be set is 23 hours and 59 minutes.

**1** Press the function button until the 'cooking time' symbol appears

**2** Press the plus or minus buttons to set a time

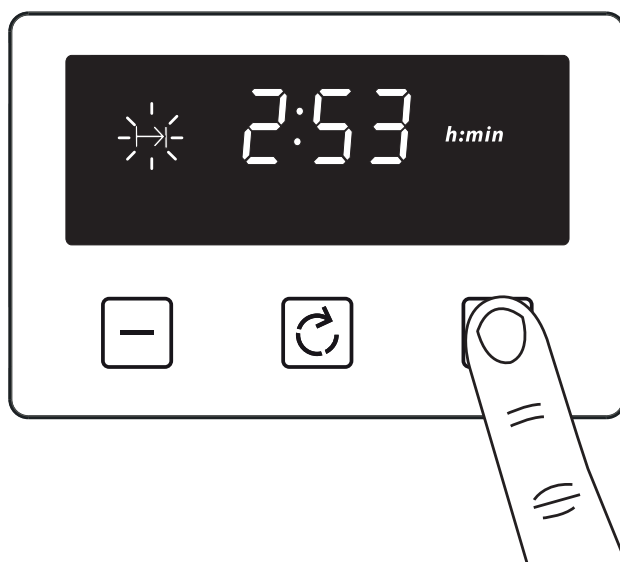
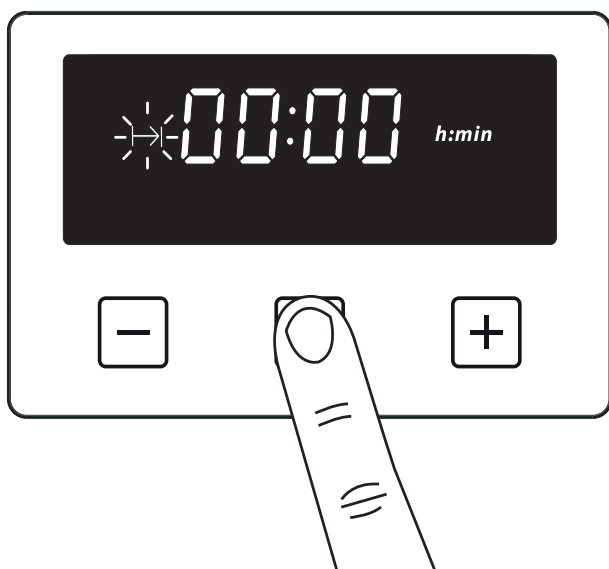

Once set, the automatic mode, auto cooking symbol and the time of day is displayed.

When cooking is completed, an alarm is heard and the manual mode symbol flashes on the display. Press the Menu button to stop the alarm and then the 'time of day' will then be displayed. Pressing the Menu button again will return to manual mode.

## To modify or cancel the cooking time

Return to the 'cooking time' function and use either the plus or minus buttons to set the time. By setting the time to '0.00', this will cancel the countdown.

# CLOCK/PROGRAMMER - STOVES RICHMOND

## Setting the end of cooking time (to set a time for the oven to turn off) Fully Automatic

Enter cooking duration as described in 'Setting the cooking time' section.

The display shows the current 'time of day' plus the 'end of cooking time' symbol. The latest 'end of cooking time' is limited to the current 'time of day' plus the maximum time that can be set (23 hours and 59 minutes).

**1** Press the function button until the 'end of cooking time' symbol appears



**2** Press the plus or minus buttons to set a time

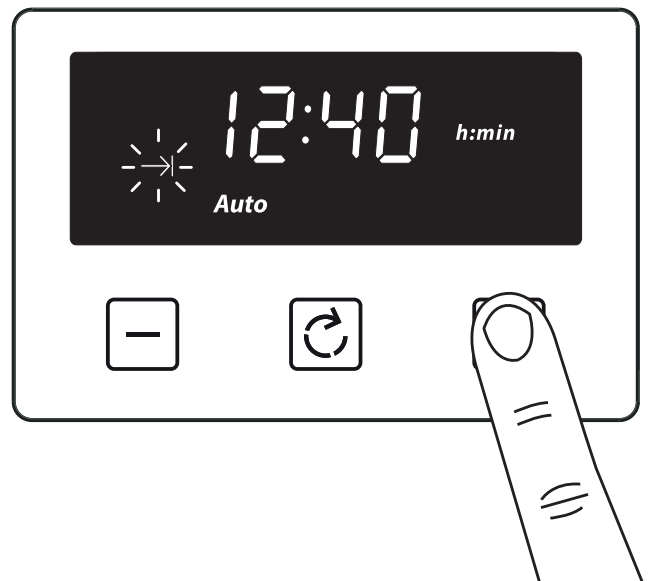

The auto cooking symbol disappears from the display once the time, the required cooking settings and temperature have been set. The appliance will not be switched on until the set cooking start time, that is the difference between the cooking end time and the cooking duration.

When cooking is completed, an alarm is heard and manual mode symbol flashes on the display. Press the menu button to stop the alarm. Pressing the Menu button again will return to manual mode.

### To modify or cancel the end of cooking time

Return to the 'end of cooking time' function and use either the plus or minus buttons to set the time. The 'end of cooking time' can be deleted by counting back using the minus button until it equals the current time of day.

# CLOCK/PROGRAMMER - STOVES RICHMOND

## Setting the volume

Press the menu button until "LX" (X = 1, 2 or 3) flashes on the display. Use the plus or minus buttons to select a tone.

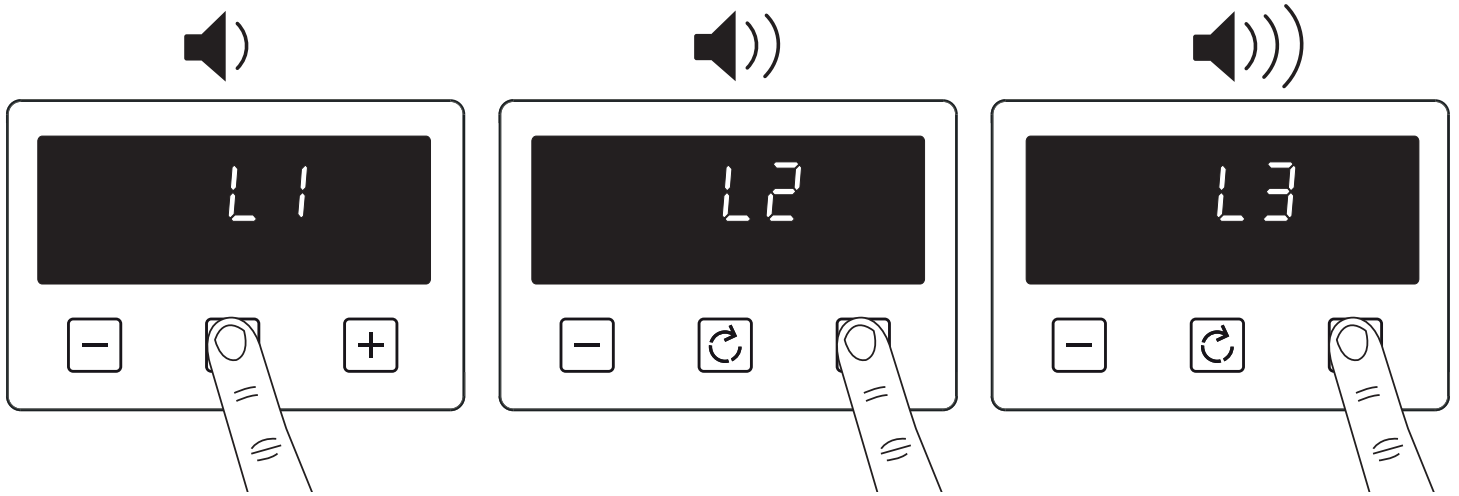

**Note:** Default tone is L3

## Activating / deactivating Key lock

**1** Press and hold the plus button for 3-5 seconds

**2**

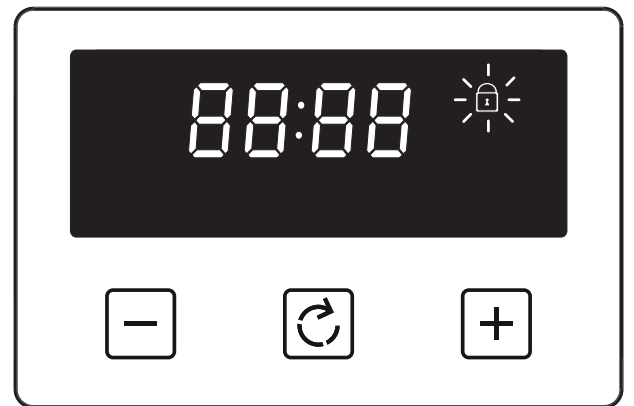
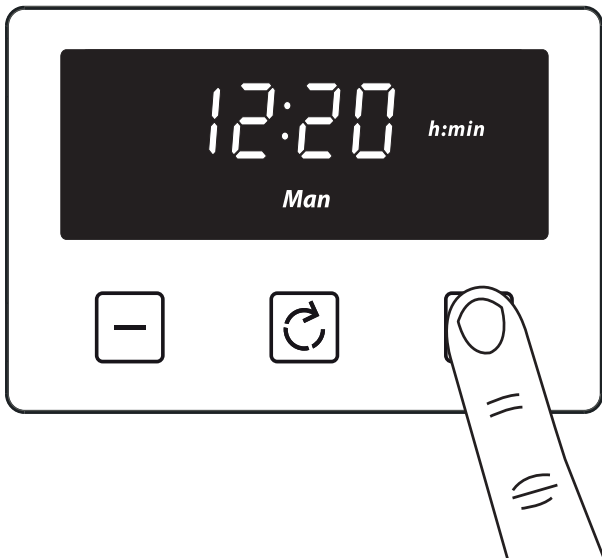

Once the Key lock is active, the buttons will be inactive. A two beep signal will be heard if the buttons are pressed.

## To deactivate the Key lock

Press and hold the plus button for 3-5 seconds. The Key lock symbol will disappear and the appliance can continue to be used.

**Note:** In case of main power loss for a short time (about 1.5 minutes), timer maintains its status. Key lock status and buzzer tone are memorized independent of the power loss duration.

# CLOCK/PROGRAMMER - BLUETOOTH CONNECTIVITY (DELUXE MODELS ONLY)

## State of Connectivity Symbol

- When the connectivity symbol is not present, the appliance cannot be connected to.
- When the connectivity symbol is blinking, the appliance is ready to be paired with a smart device using the Zeus App.
- When the connectivity symbol is solid, the appliance is connected to a smart device and can be set using the Zeus app.

## Activating / deactivating the bluetooth connectivity

**1** Press and hold the menu button for 2 seconds until a beep is heard

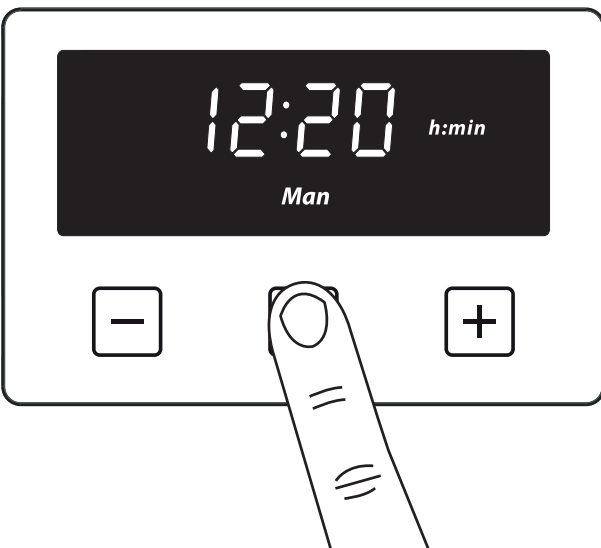

**2** The connectivity symbol will start flashing. The timer is now ready to be connected to a smart device

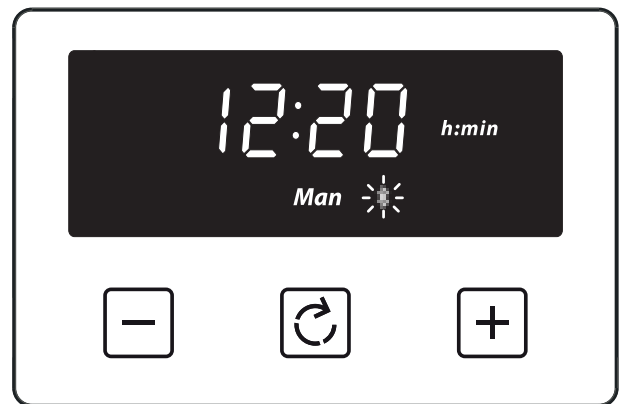

**3** Press and hold the menu button for 2 seconds. The connectivity symbol will disappear

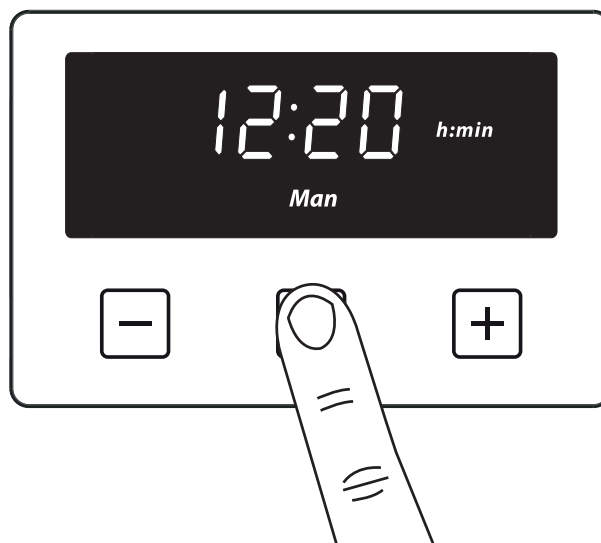

## CLOCK/PROGRAMMER - BLUETOOTH CONNECTIVITY (DELUXE MODELS ONLY)

---

### Clear Memory

- 1** Press the menu and plus button at the same time until a beep is heard.

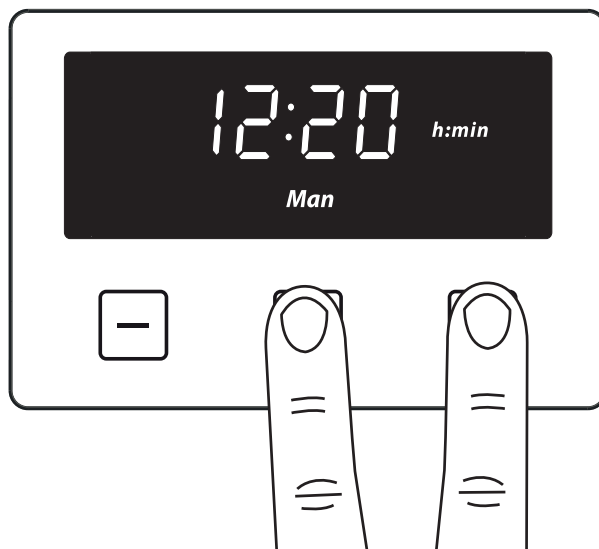

Once the beep is heard, any paired data will be cleared.

Delete pairing information in the Bluetooth Settings of your smartphone or tablet.

### How to read the 6-digit pairing code

1. When the smart device connects to the appliance through the Zeus App, the App will ask for a unique pairing code that will be displayed on the timer.

**Note:** Every time a new smart device connects through the Zeus App to the appliance, a different pairing code is displayed.

2. When prompted to enter the 6-digit code, the code will appear on the timer. The 6-digit code will scroll across the timer display from the right to the left.





**Note:** Be aware that the display can only show four digits at a time.

Please refer to the website at the front of this guide for more information or download the Zeus App (Available on iPhone and Android)

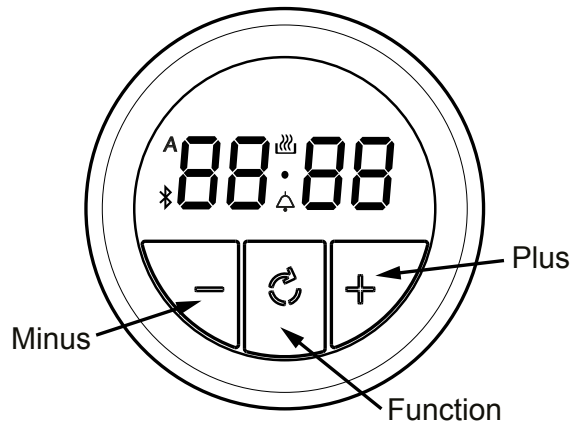
# CLOCK/PROGRAMMER - STOVES STERLING

**Note:** Your clock / programmer may not have all these functions



	Auto cooking	23:59	7-segment display
	Minute minder	99:00	Max. adjustable minute minder
	Automatic mode	23:59	Max. adjustable cooking time
	Bluetooth Connectivity (Deluxe models only)		

## Setting the time of day

**1** Press and hold the minus and plus buttons until the dot begins to flash

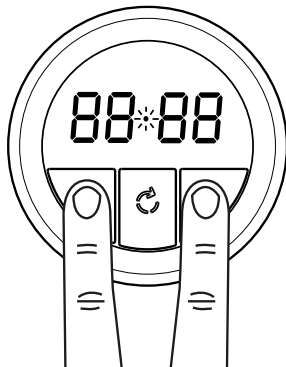

**2** Press the minus or plus buttons to set the time of day

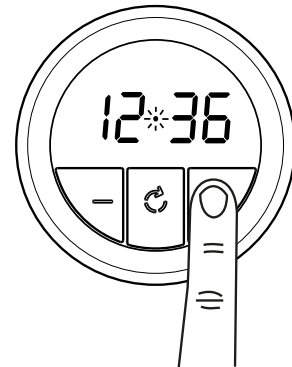

# CLOCK/PROGRAMMER - STOVES STERLING

## Setting the minute minder

- 1** Press the function button until the bell symbols begins to flash

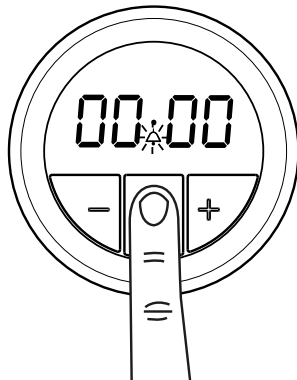

- 2** Press the minus or plus buttons to set a time

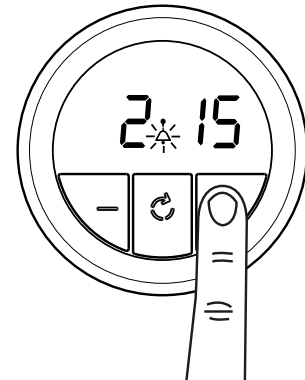

When the set time for the minute minder has completed, an alarm is heard and the minute minder symbol will flash on the display. Press any button to stop the alarm and the time of day is displayed.

## To modify or cancel the minute minder

Return to the 'minute minder' function and press the plus or minus buttons to change the time. To cancel, run down the set time with the minus button. This display will then show the time of day.

## Setting the cooking time (the duration of time the oven will operate for) Semi Automatic cooking

- 1** Press the function button until 'dur' appears on the display

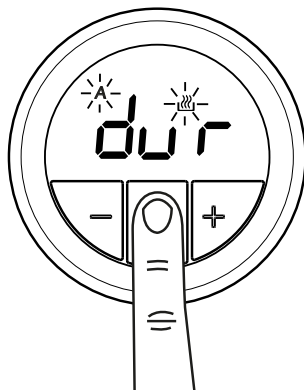

- 2** Press the minus or plus buttons to set a time

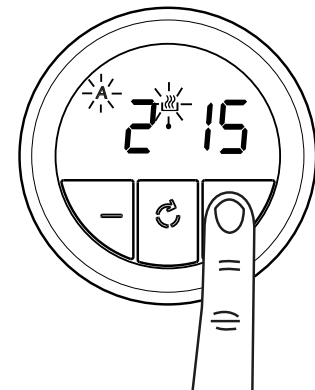

Once set, the time of day, the automatic cooking symbol and automatic mode symbol will appear on the display.

To see the remaining cooking time, press the function button twice.

When the set time has completed, an alarm is heard. Press any button to stop the alarm. The time of day is then displayed.

# CLOCK/PROGRAMMER - STOVES STERLING

## To modify or cancel the cooking time

To modify, press the function button until 'dur' appears on the display then press either the minus or plus button to set the time. To cancel, press the function button until 'dur' appears on the display then press the plus button until 0.00

## Setting the end of cooking time (to set a time for the oven to turn off) Fully Automatic

Enter cooking duration as described in 'Setting the cooking time' section.

**1** Press the function button until 'end' appears on the display

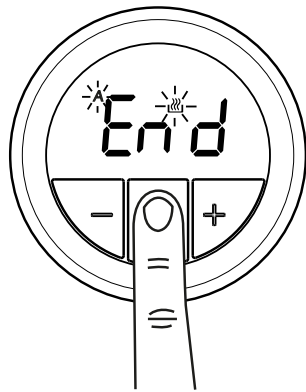

**2** Press the minus or plus buttons to set a time

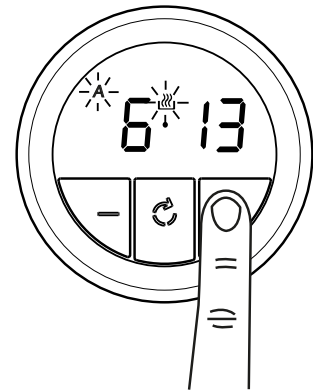

## To modify or cancel the end cooking time

To modify, press the function button until 'end' appears on the display then press either the minus or plus button to set the time. To cancel, press the function button until 'end' appears on the display, then press the minus button until the set time of day appears.

## Setting the alarm tone

Press and hold the minus button to listen to the first tone, then release the minus button and press it again to listen to the second tone, then the third tone.

Releasing the minus button after a tone has sounded, will automatically select that tone.

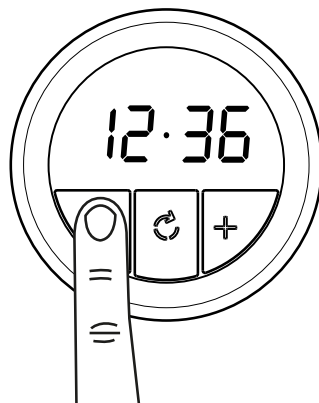

 First tone

 Second tone

 Third tone



# CLOCK/PROGRAMMER - BLUETOOTH CONNECTIVITY (DELUXE MODELS ONLY)

## State of Connectivity Symbol

- When the connectivity symbol is not present, the appliance cannot be connected to.
- When the connectivity symbol is blinking, the appliance is ready to be paired with a smart device using the Zeus App.
- When the connectivity symbol is solid, the appliance is connected to a smart device and can be set using the Zeus app.

## Activating / deactivating the bluetooth connectivity

- 1** Press and hold the functions button for 3-5 seconds until a beep is heard

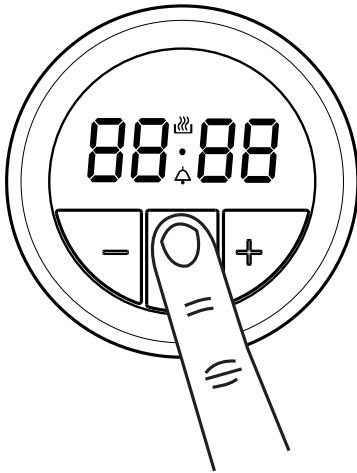

- 2** The connectivity symbol will start flashing. The timer is now ready to be connected to a smart device

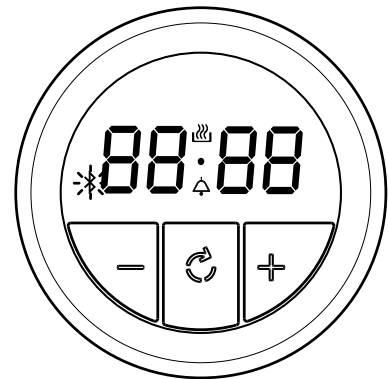

- 3** Press and hold the function button for 2 seconds. The connectivity symbol will disappear

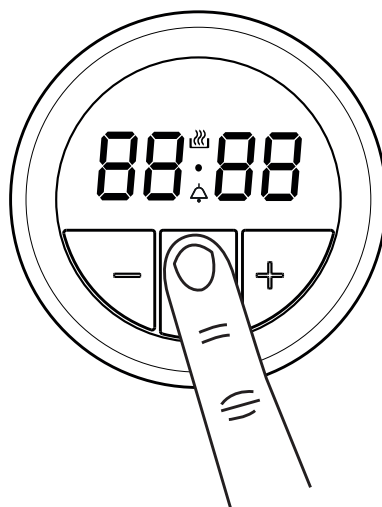

## Clear Memory

- 1** Press the function and plus button at the same time until a beep is heard.

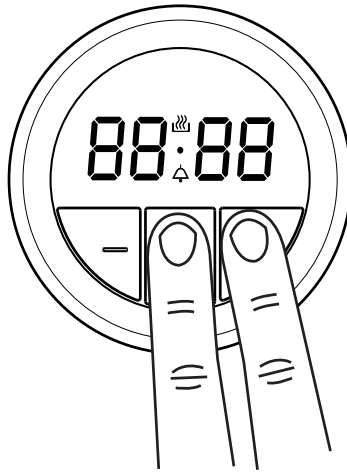

Once the beep is heard, any paired data will be cleared.

Delete pairing information in the Bluetooth Settings of your smartphone or tablet.

## How to read the 6-digit pairing code

1. When the smart device connects to the appliance through the Zeus App, the App will ask for a unique pairing code that will be displayed on the timer.

**Note:** Every time a new smart device connects through the Zeus App to the appliance, a different pairing code is displayed.

2. When prompted to enter the 6-digit code, the code will appear on the timer. The 6-digit code will scroll across the timer display from the right to the left.

**Note:** Be aware that the display can only show four digits at a time.

# USING YOUR APPLIANCE

## Removing Shelf Runners

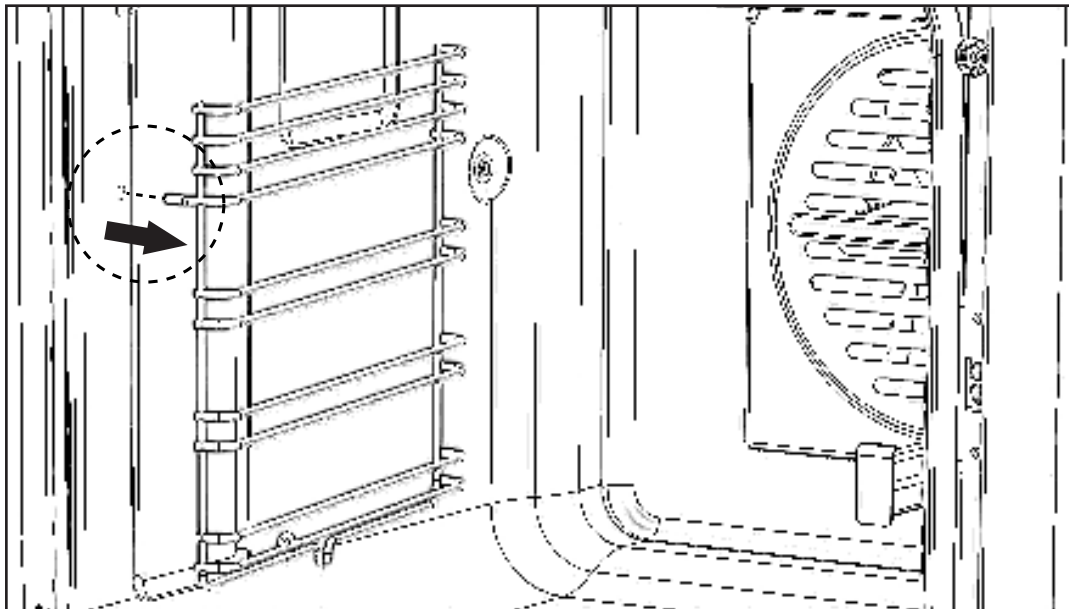
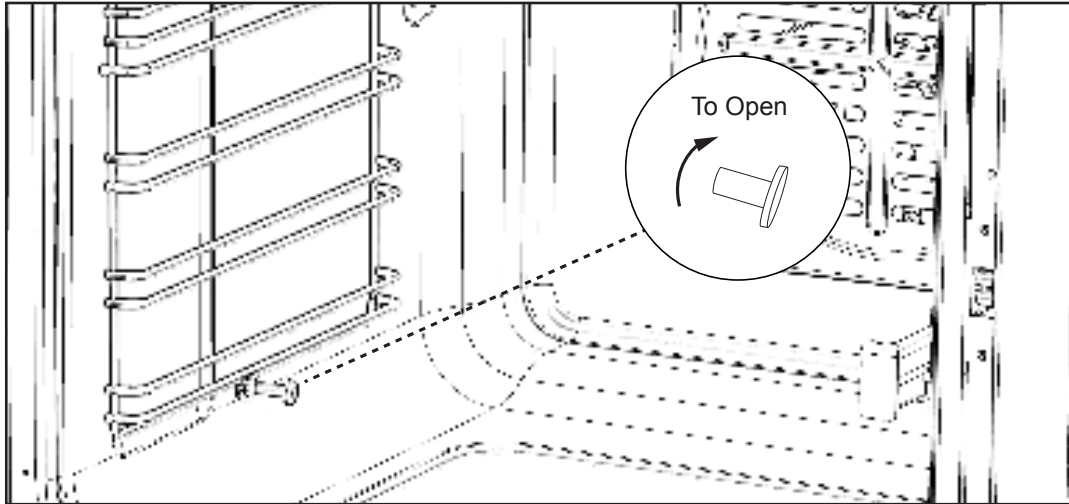

## Standard shelves

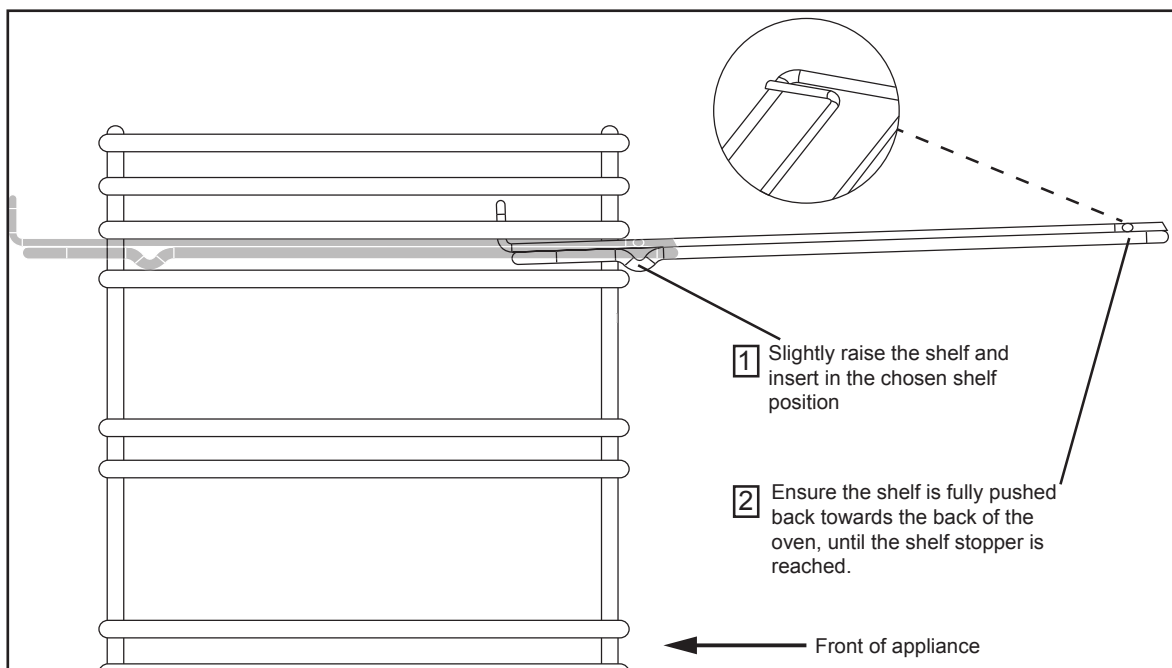

# USING YOUR APPLIANCE

## Removing Telescopic shelves

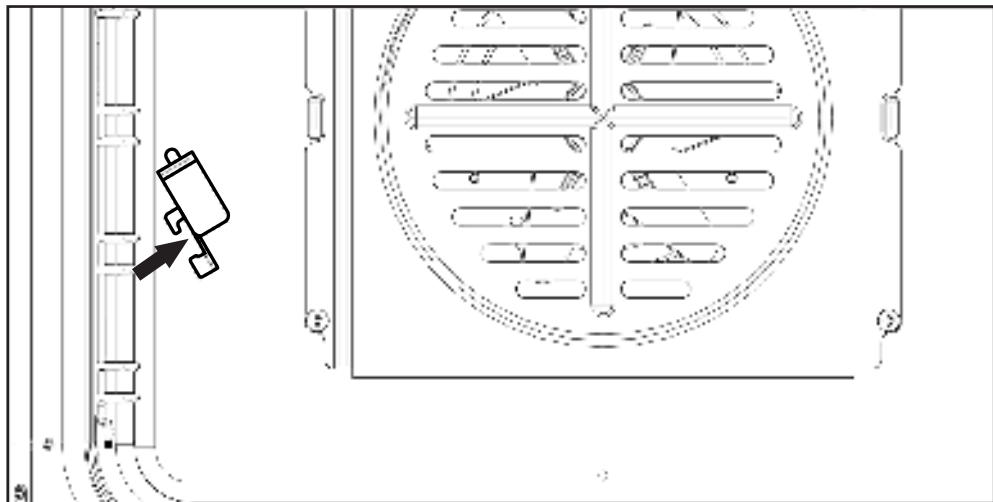
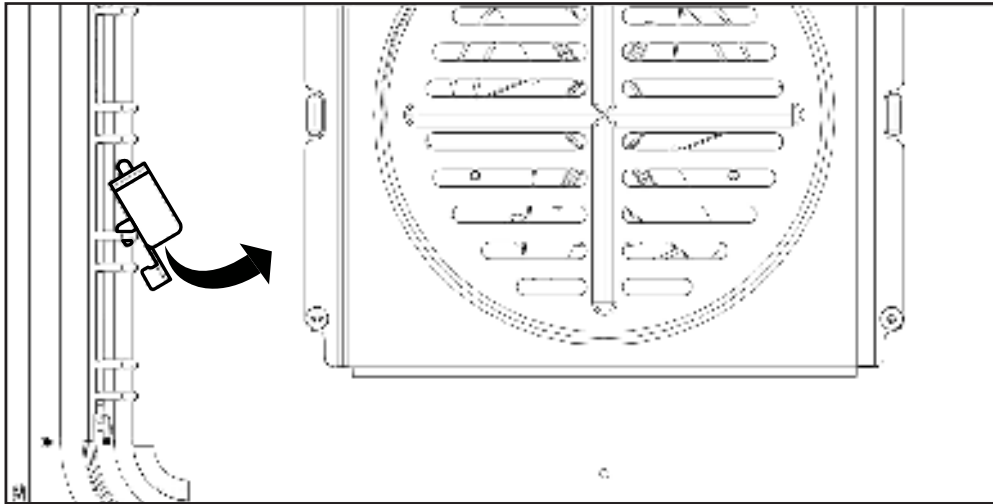
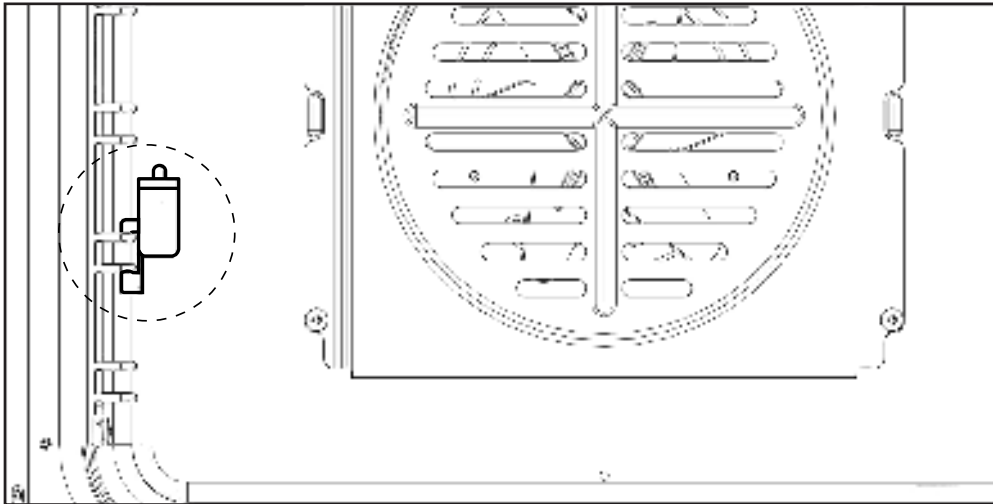

# USING YOUR APPLIANCE

---

## Full width oven pan

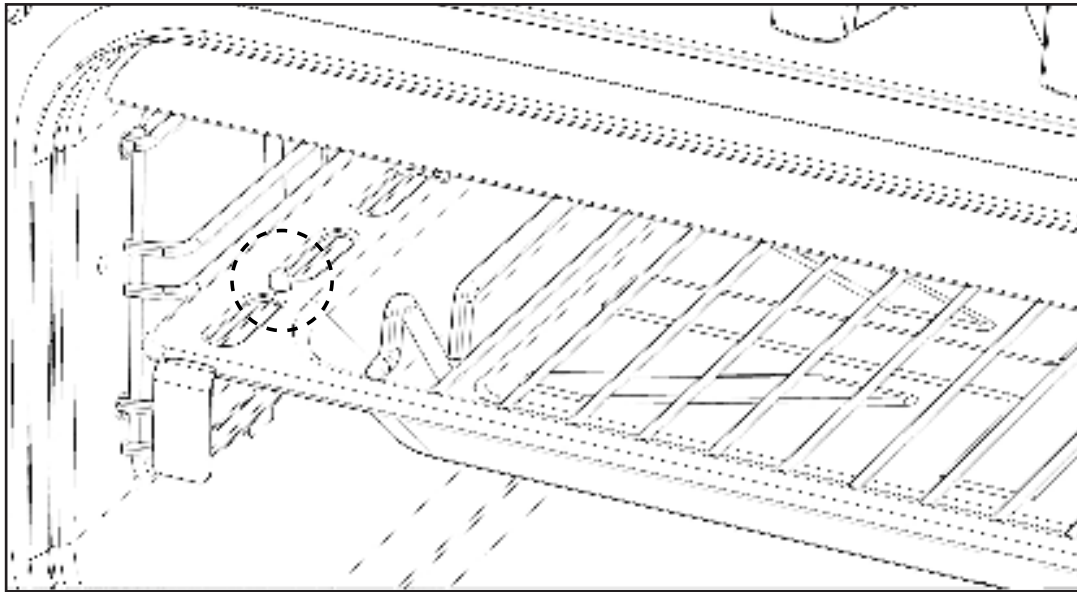

**Note:** Please ensure the wires / oven pan locate around the small tabs on the telescopic runner.

## Telescopic sliders

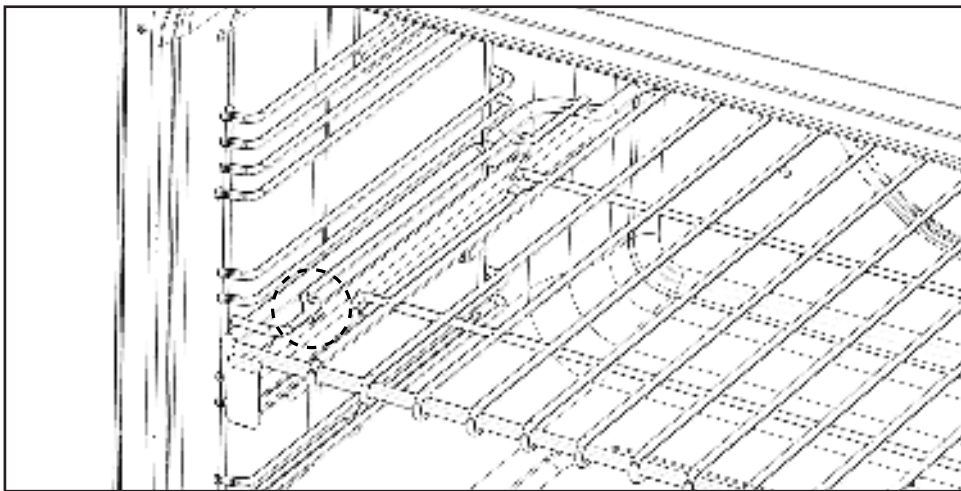

## Changing the light bulb

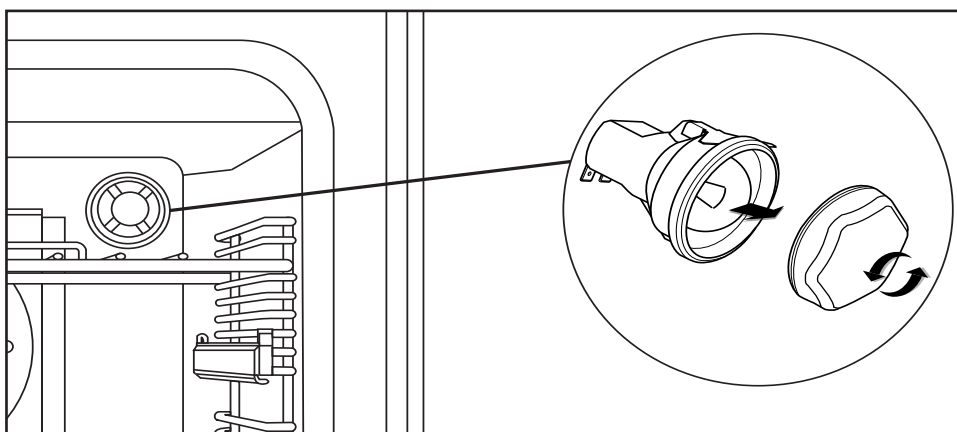

Not all appliances have the same number and type of bulbs. Before you replace your bulb, check to see what type you have. **Please remember that bulbs are not covered by your warranty.**

## Additional features

### Plate rack (if supplied)

1. Pull the shelf out of the cavity.
2. Tilt the plate warmer towards you and make sure that it hooks underneath the shelf bars at the front.
3. Drop the plate warmer carefully into position.

The plate warmer is now secure and you can place your plates into it.

Always make sure that you use oven gloves if you are putting the plate warmer into a hot, or recently used oven to prevent burns.

Always make sure that your plates are suitable for warming - some plates may shatter or crack when exposed to heat.

We recommend that you heat the oven to 70°C, or below, if you are warming plates.

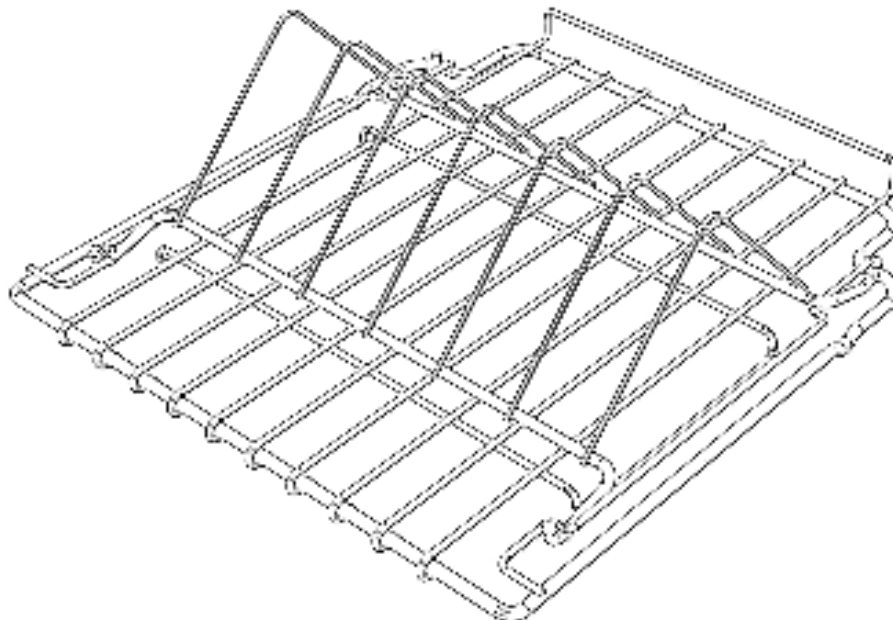

## **The Steam & Infuse accessories (Deluxe only)**

The Steam & Infuse vertical cooking system is designed to deliver an evenly cooked, healthier, flavourful result every time. Simply fill the flavour pot with stock/herbs or any other ingredients and place your poultry/meat over the top.

Supporting poultry or other meat vertically exposes all sides to the oven's heat, promoting a more even cook and allowing the fat to drip out, while flavour is infused from the inside.

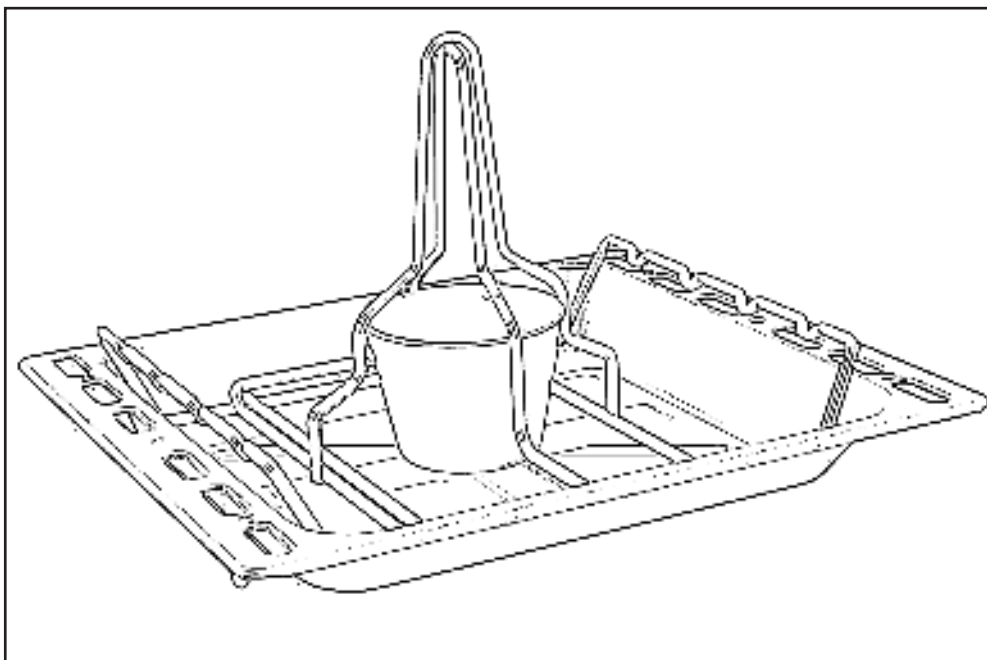

Also included are a set of skewers which are ideal for making kebabs and can be suspended over the specially designed rack.

**Note: Skewers are not to be used in tall ovens in 90cm products and should always be orientated across the oven so not to come into contact with the oven fan blades.**

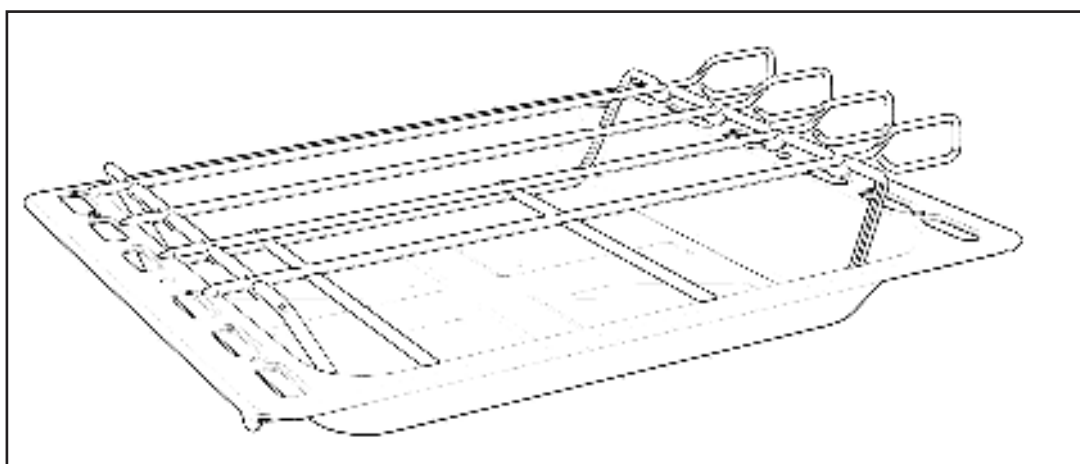

**Note: If the Steam and Infuse is not supplied as standard, it can be purchased through our Customer Care team**

Please refer to our website for further information on recipes

# CLEANING YOUR APPLIANCE

## Do's

**Note:** Always switch off your appliance and allow it to cool down before you clean any part of it.

**Note:** Please take extra care when cleaning over the symbols on the control panel, as this can lead to them fading.

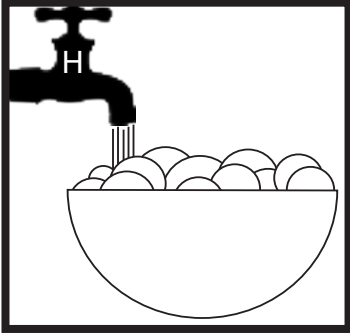

- Warm, soapy water



- Clean, wring out cloth

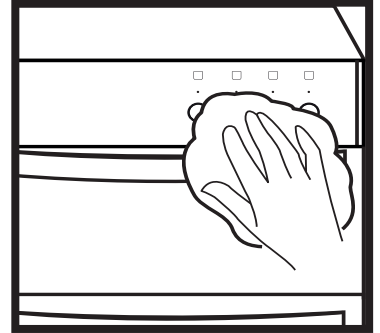

- Wipe with damp cloth
- Dry with a soft cloth

**Tips:** Some foods can mark or damage the metal or paint work e.g.; Vinegar, fruit juices and salt. Always clean food spillages as soon as possible.

## Dont's

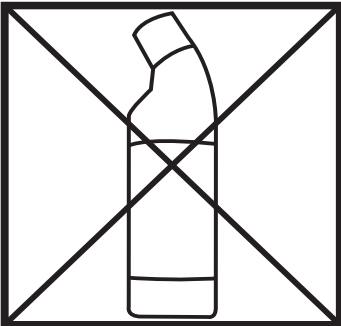

- Undiluted bleaches
- Chloride products

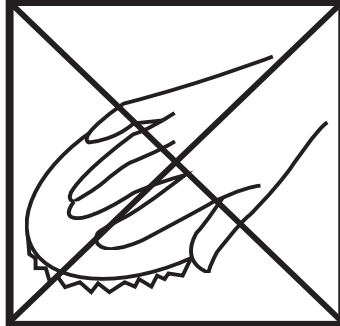

- Wire Wool
- Abrasive cleaners
- Nylon pads
- Steam cleaners

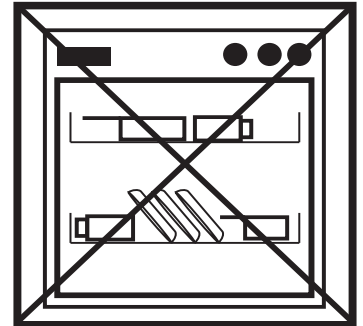

- Do not place in the dishwasher:
- Cast iron griddle
  - Pan supports

**IT IS IMPORTANT TO CLEAN YOUR APPLIANCE REGULARLY AS A BUILD UP OF FAT CAN AFFECT IT'S PERFORMANCE OR DAMAGE IT AND MAY INVALIDATE YOUR GUARANTEE.**

**IN ADDITION TO THE ABOVE, DO NOT USE METAL SCRAPERS TO CLEAN THE OVEN DOOR GLASS.**

We offer a great range of cleaning products and accessories for your appliance.  
To shop, please visit our website located at the front of this User Guide.



# **INSTALLATION INSTRUCTIONS**

---

Before you start please read the instructions.  
Planning your installation will save you time and effort.

**FAILURE TO INSTALL APPLIANCES CORRECTLY IS DANGEROUS AND COULD LEAD TO PROSECUTION.**

Installation should only be carried out by a qualified installer or engineer. We recommend that the appliance is connected by a competent person who is a member of a “Competent Person Scheme” who will comply with the required local regulations.

Our policy is one of constant development and improvement, therefore we cannot guarantee the strict accuracy of all of our illustrations and specifications. Changes may have been made subsequent to publishing.

**Please keep to the following points most carefully;**

Although every care has been taken to ensure this appliance has no sharp edges. We recommend that you wear protective gloves when installing and moving this appliance. This will prevent injury.

Ensure that you route all mains cables well clear of any adjacent heat source.

The space for air circulation, located underneath and at the back of the hob improves its reliability by ensuring that it will cool down, efficiently.

Installations should be carried out in line with the National Regulations applicable for this product type.

# BEFORE INSTALLATION

## Levelling Your Cooker

Place a spirit level on a baking sheet onto an oven shelf.

The cooker is fitted with leveling feet (1) Level your cooker to your desired height using the leveling feet at the front and rear of the cooker.

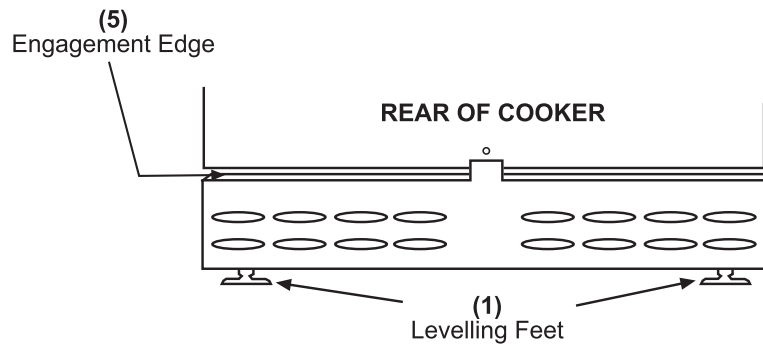

## Rear wheels (if fitted)

Adjustment of the wheel height can be made with a screw driver, through the hexagonal hole in the front plinth

## Fitting the plinth

- Make sure the appliance is raised to a height of 915mm or above before beginning. If the appliance is below 915mm - you can only fit the plinth cover labelled X. You can adjust the height using the feet (1) of the appliance. If your appliance has a storage drawer at the bottom, you access the required holes through the base of the drawer after lifting the mat.
- Open the appliance doors, and loosen screw A located on bracket (2). Do not remove this screw entirely
- Insert screw B, through slot (3) and screw into the small hole at the bottom of bracket (2). Make sure that the plinth cover is flush to the appliance, but not over tightened.

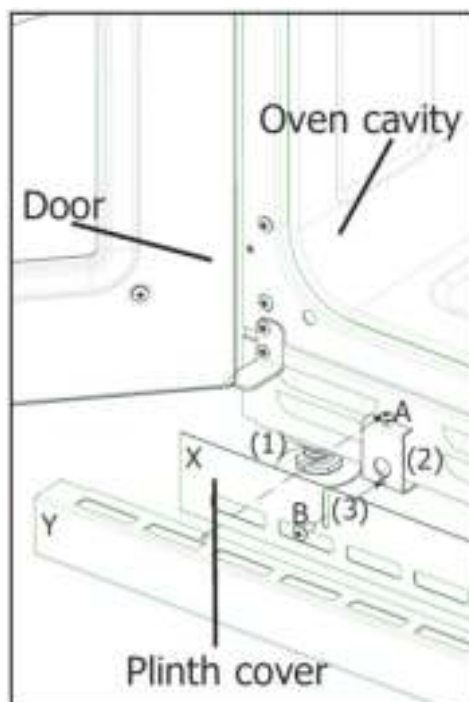

# BEFORE INSTALLATION

---

## Fitting the towel rail (if applicable)

- On the towel rail there are two holes, top (A) and bottom (B), these holes have corresponding holes on the fascia at each end.
- The 2x longer screws are designed for the top hole (A) where as the remaining screw just goes through the bottom hole (B). Both screws are M6 screws. Using the Allen key provided, tighten the screws making sure that the towel rail is flush to the fascia, but not over tightened

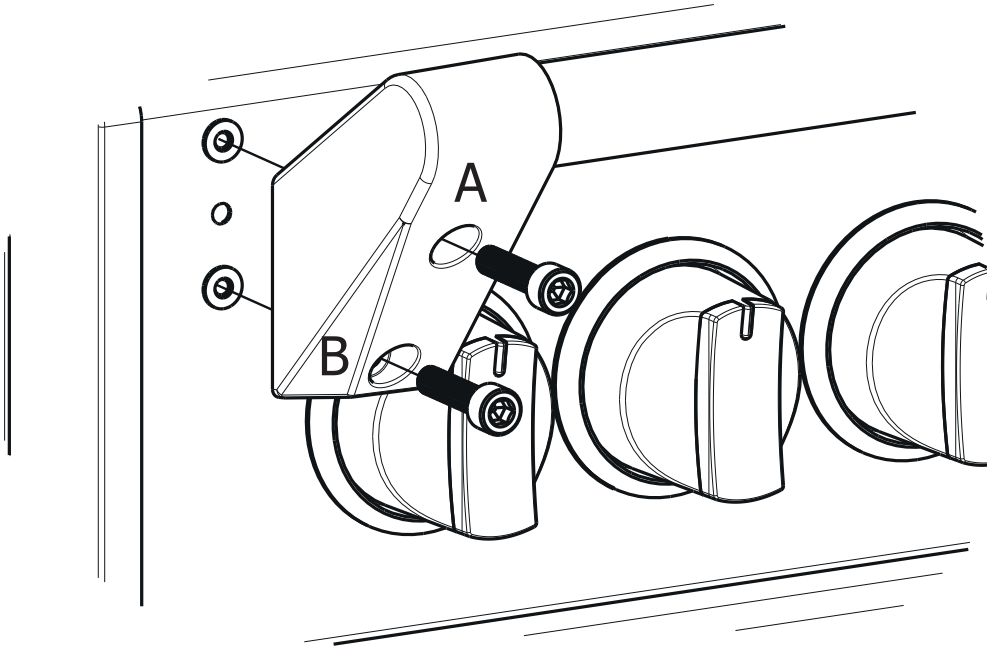

# DIMENSIONS AND CLEARANCES

## Cupboard / hood clearances

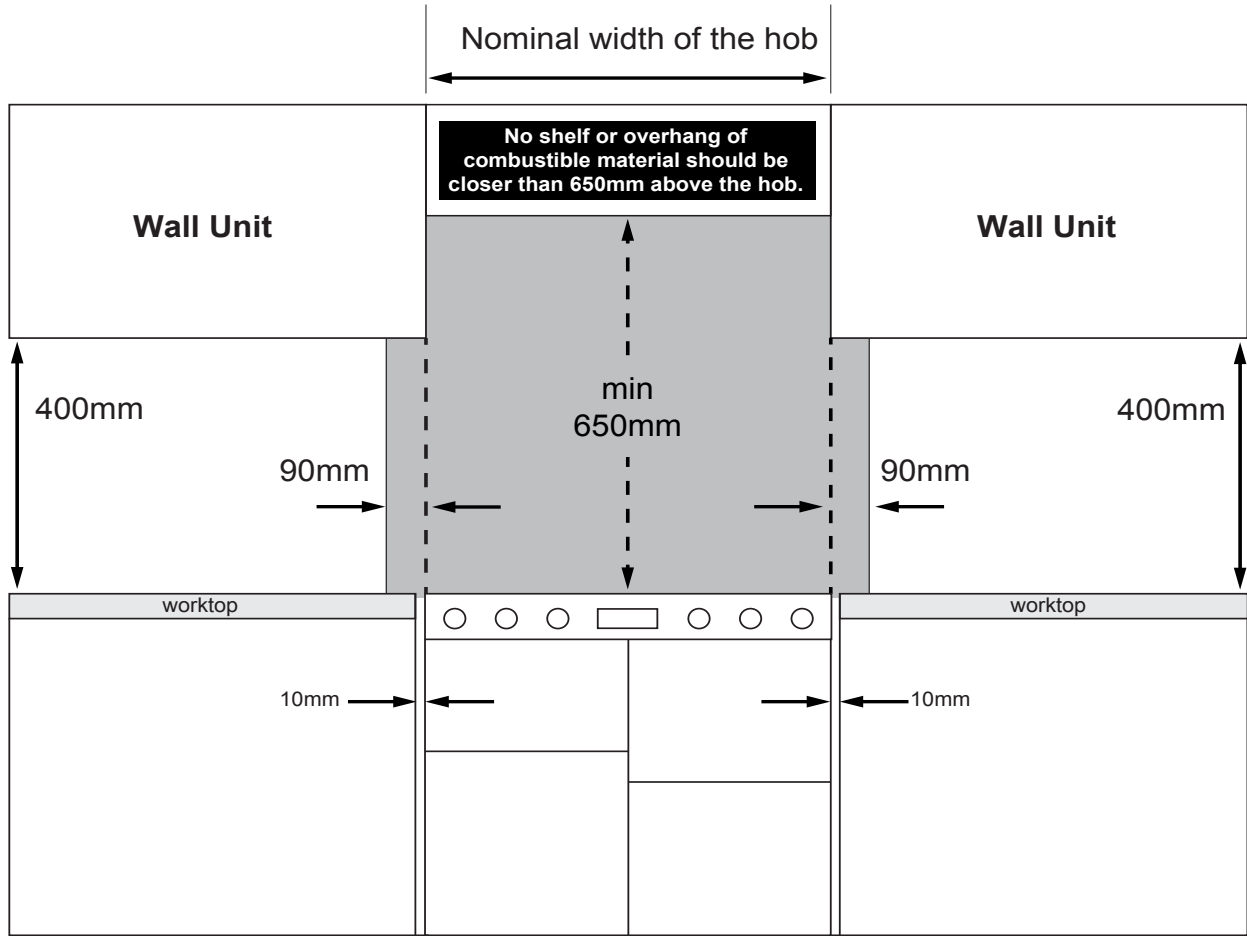

View from front

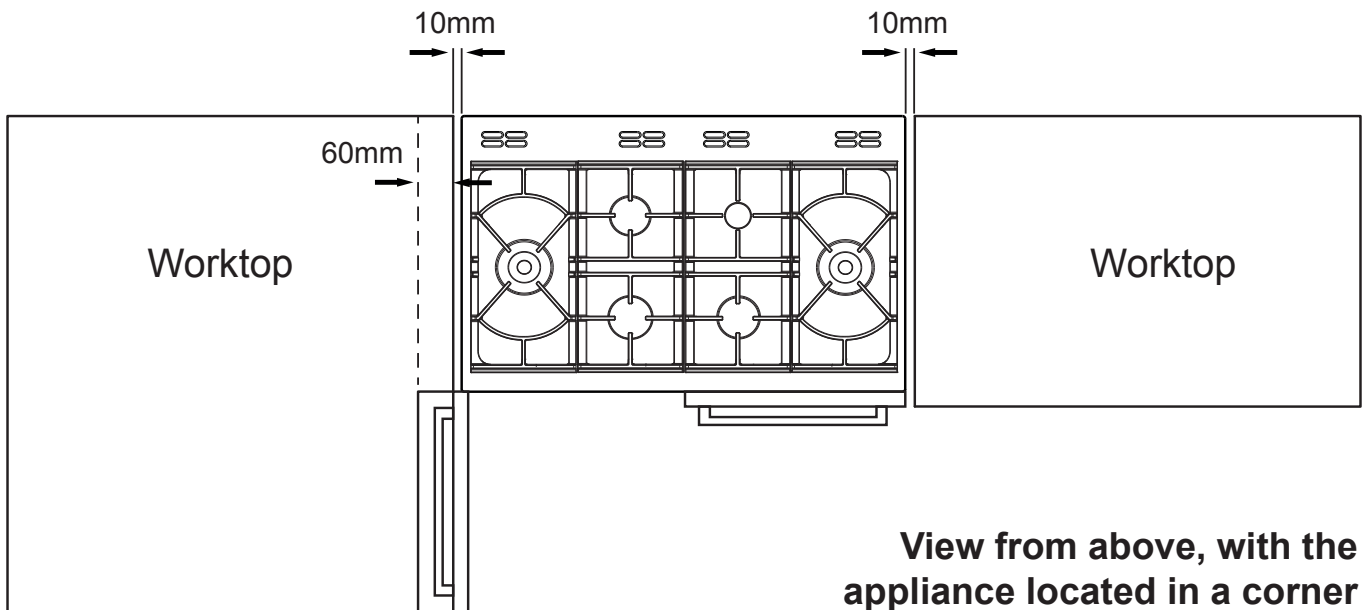

View from above, with the appliance located in a corner

- If your appliance has a side opening door, we recommend a side clearance of 60mm to allow the oven door to fully open, if placed up to a wall or cabinetry.
- The cooker must have a side clearance above hob level of 90mm up to a height of 400mm.

# CONNECT TO THE ELECTRICITY SUPPLY - TERMINAL BLOCK

**WARNING:** This appliance must be earthed.

- This appliance must be fitted to a switch providing all pole disconnection with a minimum contact separation of 3mm.
- Access to the mains terminal is gained by removing the terminal block cover at the rear of the appliance.
- Connection should be made with a suitable flexible cable with a minimum temperature rating of 70°C.
- First strip the wires then push the cable through the cable clamp.
- Connect the cable to the terminal block and tighten the cable clamp screws - see diagram.
- Refit the terminal box cover.
- Sufficient cable should be used to allow the cooker to be pulled out, but must hang clear of the floor so it does not become twisted or trapped when the cooker is pushed back.

The terminal block screws and clamps can be damaged by excessive tightening and untightening. DO NOT USE POWER TOOLS!

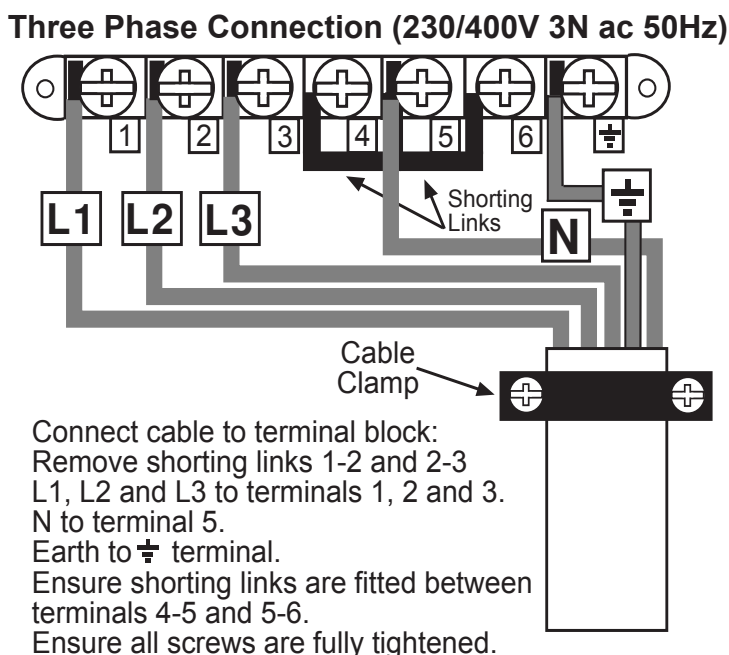
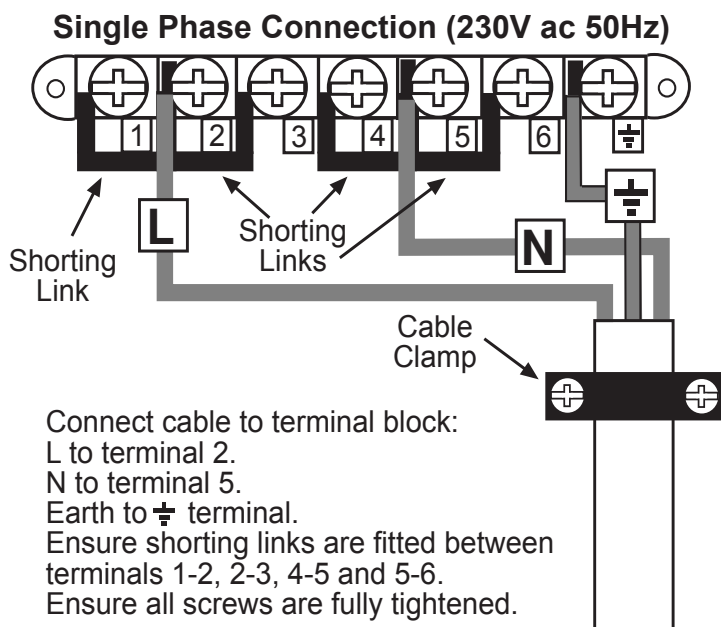

# COMMISSIONING

---

## **Check the operation of electrical components**

### **Clock Programmer/Minute Minder**

Check functions as described in the User Guide.

### **Oven light & Convection fan**

Open the main oven door. Turn the main oven control knob to the defrost setting. Check the oven light and convection fan both come on. Turn control knob back to 'OFF' position.

### **Cooling Fan**

Open the grill door. Turn the grill control knob to the full power setting . Check that the cooling fan operates. Turn control knob back to 'OFF' position and check cooling fan switches off immediately.

**Before leaving the installation hand over the User Guide to the customer**

Please keep this handbook for future reference, or for anyone else who may use the appliance.

# TECHNICAL DATA

## Electric Range

### Hob top

Electrical supply / load			
Electrical supply	Hotplate	Zone	Appliance Size (cm) / Load kW
			<b>90 100 110</b>
240v	Induction	Left hand front	1.60 boost to 3.00
		Left hand rear	1.60 boost to 3.00
		Right hand front	1.10 boost to 2.20
		Right hand rear	1.40 boost to 3.00
		Middle	2.30 boost to 3.70

### Appliance

Electrical supply / load				
Electrical supply	Oven	Appliance Size (cm) / Load kW		
		90	100	110
240v	Multifunction	3.1	3.1	3.1
	Fanned	2.0	2.0	2.0
	Fanned (90cm tall oven)	2.5	N/A	N/A
	Fanned (90cm deluxe oven)	1.7 / 3.0	N/A	N/A
	Dual variable grill	1.7 / 2.7	1.7 / 2.7	1.7 / 2.7
	Conventional top	1.4	1.4	1.4
	Slow Cook	N/A	0.17	0.17

Oven Lamps / Fans	
Lamps (90cm deluxe Right Hand Oven)	25W each
Lamps	40W each
Cooling fans	10W each
Oven stir fans	30W each

Electrical supply / load		
Appliance Size (cm)	Electrical supply	Max. load (kW)
90	220 - 240v ~ 50 Hz	14.50 - 15.85
90 Deluxe		14.95 - 16.38
100/110		14.23 - 15.53