

**NU FORCE**

# BE6i

Bluetooth in-ear headphones

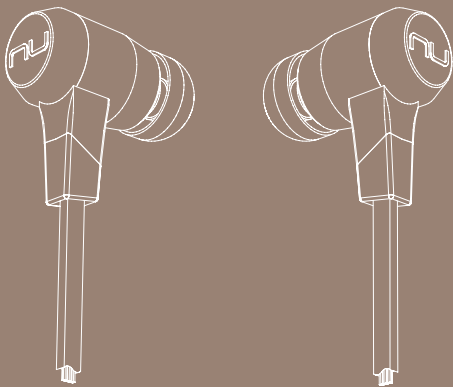









User manual

Regulatory model name: APBELI

# Contents

- **WHAT'S IN THE BOX**
- **BE6I EARPHONES**
- **THE BASICS**
  - Charging your BE6i**
  - Checking battery level**
  - Bluetooth pairing**
  - Power On/ Power Off**
  - Wearing your BE6i**
  - Handling phone calls**
  - Listening to music**
  - Pairing with a laptop**
  - Pairing with a Mac**
- **MISCELLANEOUS**
  - Multipoint connections**
  - Restoring factory settings**
  - Voice prompts list**
  - Disclaimer**
  - FCC Interference statement**
  - Specification**

# WHAT'S IN THE BOX

<p>BE6i earphones (with inline controller and microphone)</p>	
<p>Silicon tips (in L/M/S) 2 types of silicon tips Total of 12 silicon ear tips</p>	
<p>Comply tips (two pairs in L/M)*</p>	
<p>Stabilizers (1 pair)</p>	
<p>Cable loop for adjusting the length of cable</p>	
<p>Carry case</p>	
<p>Charging cable (Micro-USB)</p>	
<p>Basic user's manual</p>	
<p>Safety Instruction</p>	

\*For replacement or additional ear tips [www.complyfoam.com](http://www.complyfoam.com) .

# BE6i EARPHONES

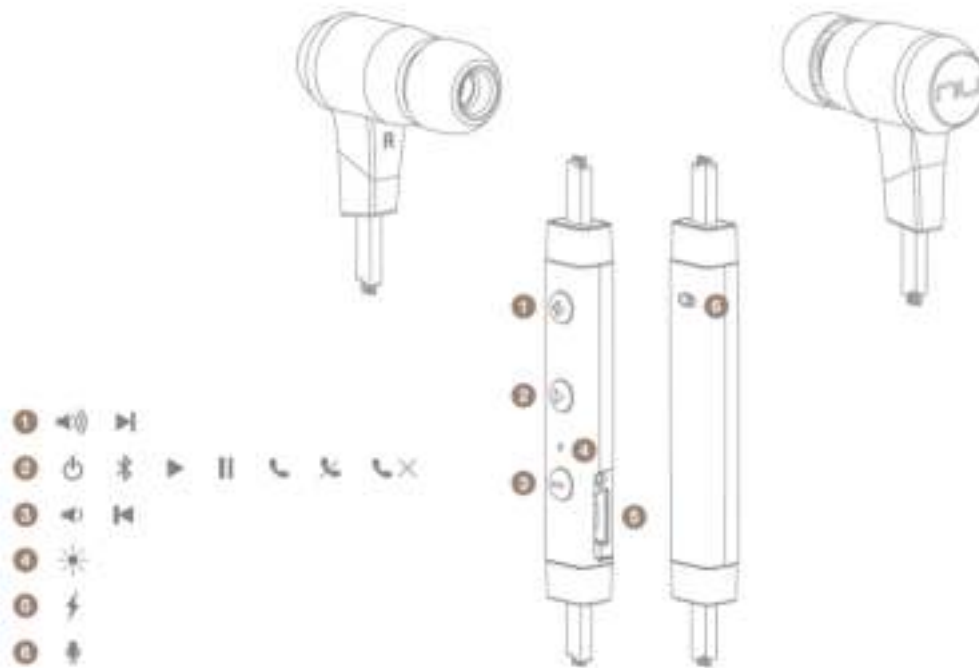

1. Volume Up Button
2. Power/Function Button
3. Volume Down Button
4. LED Indicator
5. Charging port
6. Microphone

# The BASICS

## Charging Your BE6i

Although your BE6i in-ear headphones come with a partially charged battery, it is recommended that you fully charge your BE6i before first use.

1. Open the charge port cover on the controller.
2. The charge cable should be connected to the charge port and either to a PC or a dedicated USB charger.
3. When charging, the LED indicator is red.
4. LED Indicator turns blue once charging is complete.

*NOTE: It takes up to 2.5 hours to fully charge the BE6i.*

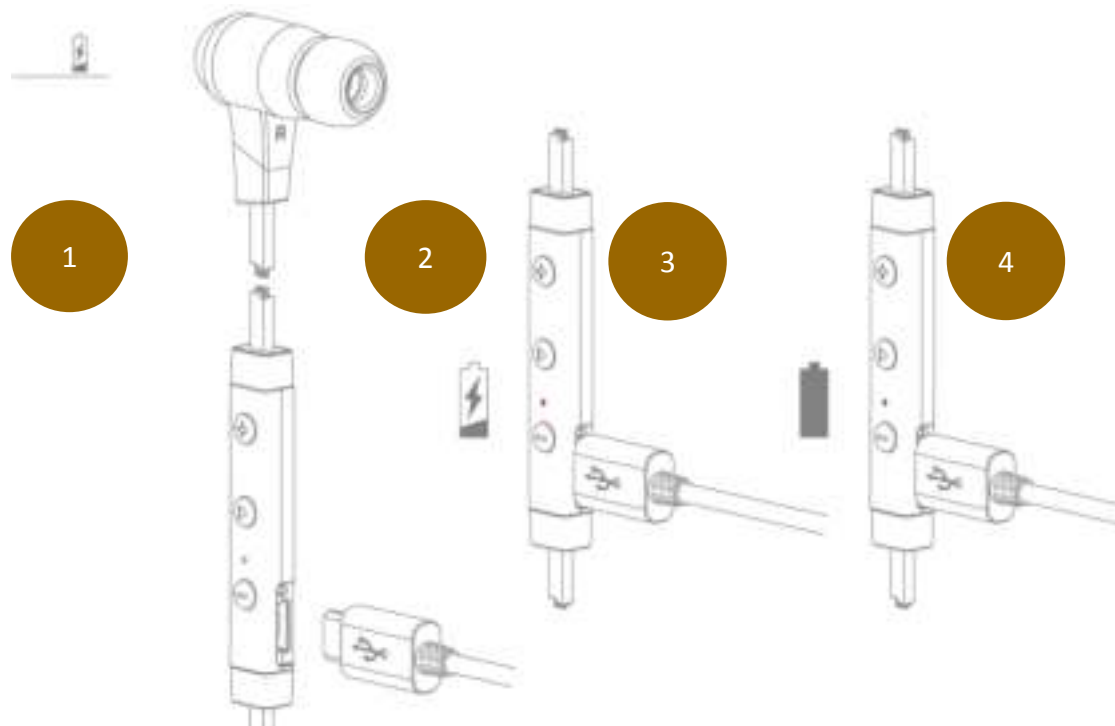

## Checking Battery Level

You can check the battery level of your BE6i with the LED indicator \*

To check battery level:

1. Press the Power/Function, volume up, and volume down buttons simultaneously.
2. The LED indicator will flash red and blue simultaneously. The battery level will be indicated by the number of flashes, as described in the table below:

### Number of Flashes Battery Level

Number of flashes	Voice prompts(enable)
2	Battery low
3	Battery at 50%
5	Full battery

*NOTE: When the battery level is very low, you will hear a beep or a "Battery Low" voice prompt from your BE6i every 2 minutes when the estimated battery reserve remaining time is under 15minutes.*

*IN ADDITION:*

1. *When the Voice prompts are switched off you will hear a beeping sound (A short double tone) every two minutes.*
2. *Users with iOS devices and some Android models will be able to view the battery status on their device 's display*

*\*On some Android and all Windows operated devices you cannot check the battery level for your BE6i when you listen to music, in the middle of a phone call or in pairing mode.*

## Bluetooth Pairing

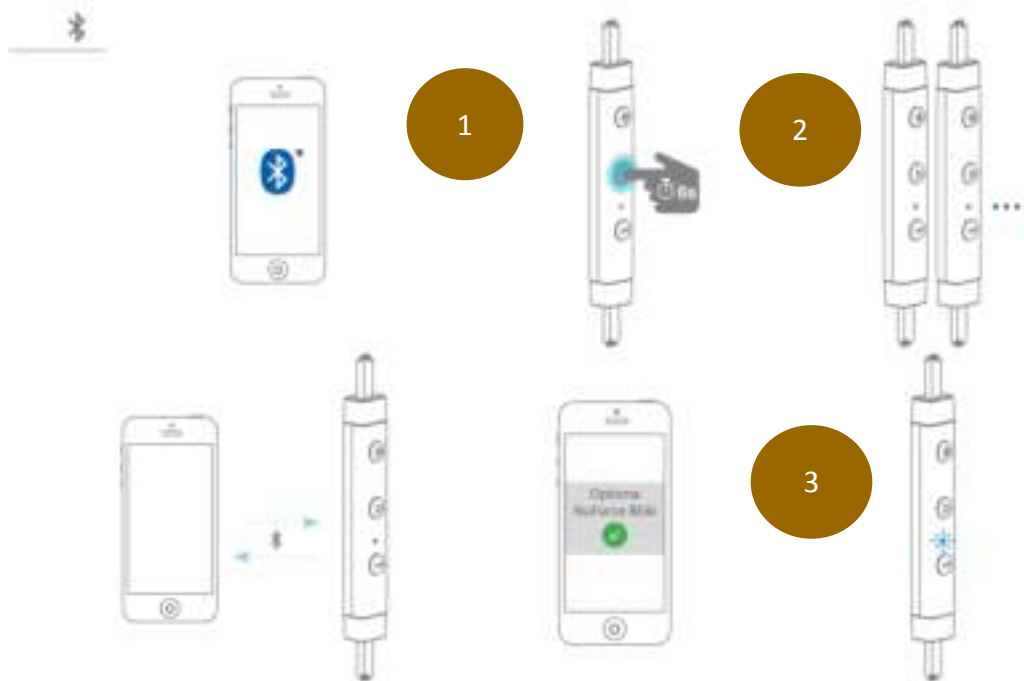

### Using your BE6i for first time

#### Pairing BE6i with source device

1. Press and hold the BE6i's Power/Function button for 6 seconds until the LED indicator light flashes blue/red. Your BE6i is now in pairing mode.
2. Turn on *Bluetooth*® on your source device, then select "Optoma NuForce BE6i" once it appears on the device list.  
**NOTE: Consult your source device's user manual for instructions on activating Bluetooth.**
3. Once successfully paired, the LED indicator will flash blue and you hear "Primary device connected" (when voice prompt enabled) from your BE6i, or a beep if voice prompt is not enabled.

#### Please note:

- A. You must always enter "Pair" mode from a powered-off state. Otherwise, pushing the Power/Function button for more than 3 seconds from a powered-on state turns the BE6i off.
- B. If left inactive in pairing mode, your BE6i will automatically power

off after 3 minutes.

- C. Your BE6i can store pairing information for up to eight devices. To pair additional devices to your BE6i ensure that your BE6i is not concurrently connected to any device, then repeat the steps 1,2,3 outlined above.

In case where your BE6i have already stored pairing information for eight devices and a ninth device is paired, the stored information for the very first device will be deleted.

## Power On/Power Off

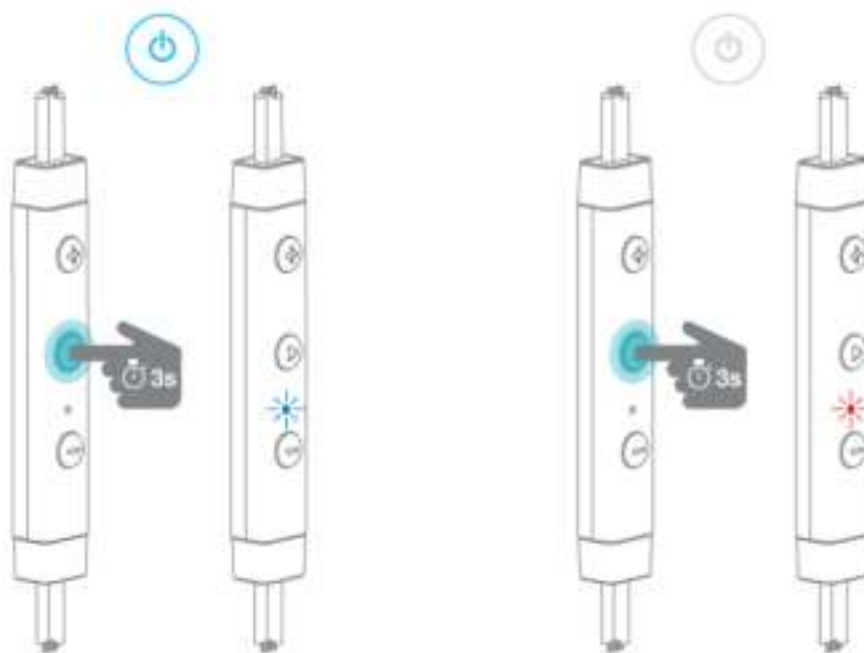

To power on your BE6i, press Power/Function button for about 3 seconds until the LED indicator flashes blue and you hear the “Power on” when voice prompt is activated or a beep if the voice prompt is not used.

### NOTE:

Once you have successfully paired the BE6i to a Bluetooth-enabled device, the BE6i will automatically connect with that device once it is powered on again. For more information check “Bluetooth Pairing” section.

If you have stored pairing information for multiple devices and more than one of those devices is Bluetooth enabled, the BE6i will automatically connect with the most recently paired device and will also enable multipoint connection.

For more information read section “Multipoint Connections”.



To turn the BE6i to OFF, push Power/Function button for about 3 seconds until the LED indicator turns red and you hear the “Power off” ” when voice prompt be activated or a beep if the voice prompt is not used.

## Wearing Your BE6i

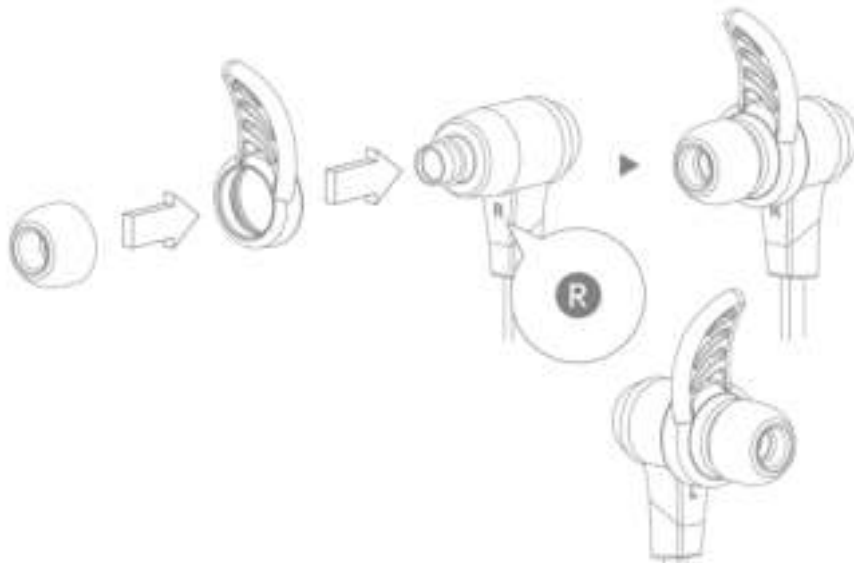

To ensure a secure and comfortable fit when wearing your BE6i:

1. Install the stabilizers on the BE6i.
2. Select right size of ear tips and install tips on BE6i.
3. Rotate the stabilizers and place the BE6i into each ear so that they are positioned comfortably.

Magnetic caps at the end of the earphones let users click the earphones together and secure them around user’s neck for ease of use.

## Handling Phone Calls

When your BE6i are connected to a *Bluetooth*-enabled smartphone you can handle your phone calls directly using your BE6i in ear headphones.

The followings describe phone call options:

Call option	Status	Action
Answer a call	Incoming call	Tap the Power/Function button
Decline a call	Incoming call	Press the Power/Function button for 2 seconds
End a call	In a call/outgoing call	Tap the Power/Function button
Redial the last number	Standby/connected	Double tap the Power/Function button
Mute on or mute off microphone	In a call/outgoing call	Tap the Volume Up and Volume Down simultaneously
Switching handset/earphone voice	In a call	Press the Volume Up and Volume Down buttons simultaneously for 2 seconds
Adjust the volume		Tap the Volume Up or Volume Down button
Activate Siri (iOS) or Google Voice Search (Android)	Standby/Connected	Tap the Power/Function and Volume Up buttons simultaneously

## Listening to Music

You can enjoy and control Audio through the in line controller on your BE6i.

Audio option	Action
Play or pause audio	Tap the Power/Function button
Skip to next track	Press the Volume Up button for 2 seconds
Play previous track	Press the Volume Down button for 2 seconds
Adjust the volume	Tap the volume up or volume down button

**\*Please note: when muting the BE6i or reactivating it from MUTE there will be a very slight delay**

## Pairing with a Laptop

The connection instructions below apply to owners of Windows 7, 8, 8.1 and 10.

1. Power your PC/Laptop
2. Find “Bluetooth Settings”
3. Switch your laptop Bluetooth to “On”
4. Turn the BE6i to “Pairing Mode”
5. When the BE6i is discovered by your laptop left click on “Pair”
6. Right click on the speaker symbol at the bottom right side of the screen 
7. From the dropdown menu right click on the “Playback Device”
8. Please choose and right click the “Optoma NuForce BE6i stereo ready” (see image below text)
9. Click on HEADPHONES to set the “Headphones Optoma NuForce BE6i” as default device
10. Press OK



## Pairing with a Mac

The connection instructions below apply to owners of all current and recent iOS versions

1. Power your Mac
2. Open “System Preferences”



3. Click on the Bluetooth symbol



4. Turn the Optoma NuForce BE6i to “Pairing Mode”
5. When the Optoma NuForce BE6i is discovered by your Mac click on “Pair”



6. Your Mac is now ready to play audio via the BE6i

# MISCELLANEOUS

## Multipoint Connections

If you have stored pairing information for multiple devices and more than one of those devices have Bluetooth enabled at the same time, your BE6i will enable multipoint connection.

Multipoint connection allows your BE6i to hold connections with two devices at the same time while playing audio signal from only one of the two devices.

Multipoint connection works in the following ways:

- Your BE6i automatically connects with the most recently paired device (“Primary device”).
- You must manually connect the second device (“Secondary device”) to your BE6i via its operating system.
- The BE6i will prioritize the audio from Primary device.
- You can control Primary device using the BE6i in line controller.
- When Primary device is idle, your BE6i can receive audio from Secondary device.
- Secondary device must be controlled directly from its operating system.
- Simultaneous audio from both devices is disabled.

## Restore Factory Settings

When you restore the BE6i to its factory settings, the paired devices stored will be deleted.

To restore factory settings:

- 1** Ensure that your BE6i are not connected to any device.
- 2** Put the BE6i in pairing mode.
- 3** Press simultaneously the Power/Function, Volume Up, and Volume Down buttons for 2 seconds until the LED indicator flashes red five times and you hear five short tones from the BE6i.

Because all pairing information is deleted after restoring factory settings, the BE6i will directly enter pairing mode once powered on.

## Voice Prompts list

The BE6i are pre-loaded with English voice prompts

“Power On”

“Power Off”

“Full Battery”

“Battery at 50%”

“Battery Low”

“Primary device connected”

“Secondary device connected”

“Device disconnected”

“Mute On”

“Mute Off”

“Pairing Mode Activated”

“Redial Last Number”

“Transfer Audio”

“Voice Dial”

“Voice Prompts Enabled”

Audio option	Action
Activate voice prompts	Press the Power/Function and Volume Up buttons simultaneously for 2 seconds
Turn off voice prompt	Press the Power/Function and Volume Down buttons simultaneously for 2 seconds

## Disclaimer

Please be advised, the BE6i is equipped with the latest technology however functionality may vary by device.

# Federal Communication Commission Interference

## Statement

This equipment has been tested and found to comply with the limits for a Class B digital device, pursuant to Part 15 of the FCC Rules. These limits are designed to provide reasonable protection against harmful interference in a residential installation.

This equipment generates, uses and can radiate radio frequency energy and, if not installed and used in accordance with the instructions, may cause harmful interference to radio communications. However, there is no guarantee that interference will not occur in a particular installation. If this equipment does cause harmful interference to radio or television reception, which can be determined by turning the equipment off and on, the user is encouraged to try to correct the interference by one of the following measures:

- . Reorient or relocate the receiving antenna.
- . Increase the separation between the equipment and receiver.
- . Connect the equipment into an outlet on a circuit different from that to which the receiver is connected.
- . Consult the dealer or an experienced radio/TV technician for help.

***FCC Caution:*** To assure continued compliance, any changes or modifications not expressly approved by the party responsible for compliance could void the user's authority to operate this equipment. (Example - use only shielded interface cables when connecting to computer or peripheral devices).

### ***FCC Radiation Exposure Statement***

This equipment complies with FCC RF radiation exposure limits set forth for an uncontrolled environment. This equipment should be installed and operated with a minimum distance of 0.5 centimeters (.20 of an Inch) between the radiator and your body.

This transmitter must not be co-located or operating in conjunction with any other antenna or transmitter.

The antennas used for this transmitter must be installed to provide a separation distance of at least 0.5 centimeters (.20 of an Inch) from all persons and must not be co-located or operating in conjunction with any other antenna or transmitter.

This device complies with Part 15 of the FCC Rules. Operation is subject to the following two conditions:

- (1) This device may not cause harmful interference, and
- (2) This device must accept any interference received, including interference that may cause undesired operation.

# Specification

<b>Connection type</b>	Bluetooth 2.4Ghz	
<b>Bluetooth type</b>	V4.0+EDR Compliant	
<b>Bluetooth profile</b>	HSP 1.2, HFP 1.6, A2DP 1.2, AVRCP 1.4 , aptX, AAC	
<b>Codec</b>	SBC, aptX, AAC	
<b>Cable length</b>	550	mm
<b>Driver Type</b>	Dynamic	
<b>Driver size</b>	10	mm
<b>Impedance</b>	20	Ohm
<b>Battery life (estimated)</b>	Up to 8 hours	
<b>Battery type</b>	Lithium-ion battery, Cylindrical Type, Typical 3.7V/120mAh	
<b>Microphone sensitivity</b>	-42dB	
<b>Frequency response</b>	20Hz - 20kHz	
<b>Sensitivity</b>	95dB +/-3dB at 1KHz	
<b>power consumption</b>	15mA at A2DP mode, speaker output 75dB SPL	
<b>Range</b>	Up to 10m	
<b>Weight</b>	19	Grams







[www.optoma.com](http://www.optoma.com)