

ENGLISH

XB3

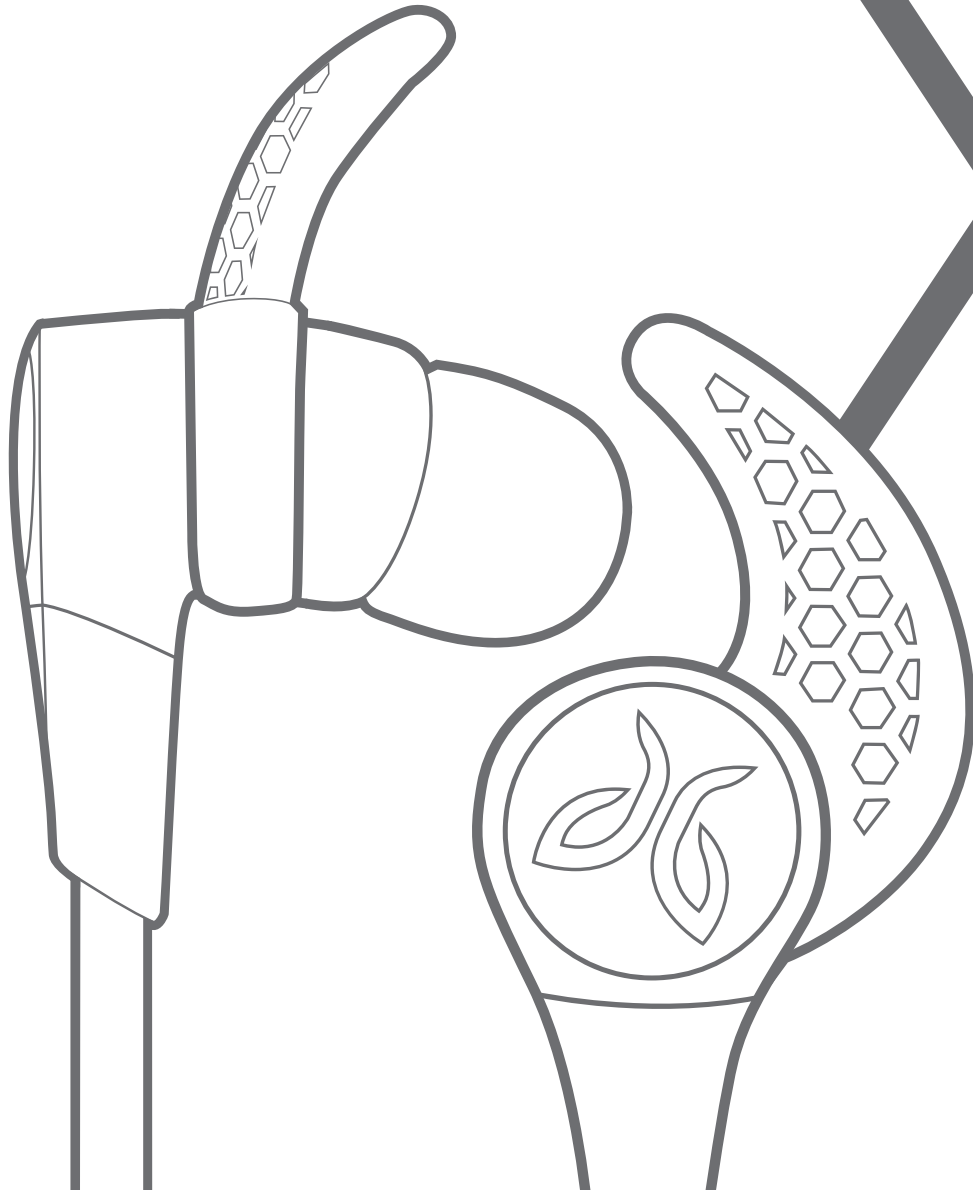

USER GUIDE

WELCOME

In The Box	2
Charging / Battery Status	3
Pairing	5
Finding Your Perfect Fit.....	7
Choosing Your Setup	7
Fit for Sport Use.....	8
Fit for Casual Use	11

DETAILED INSTRUCTIONS

Button Functionality.....	14
The MySound App	17
Multipoint - Connection to multiple devices	19
ShareMe	20
Smartwatches	22
Troubleshooting	23
Specifications	24
Warranty, Warnings & Safety	25

WELCOME

**THANKS FOR PURCHASING
JAYBIRD X3. WE BRING MUSIC
WHERE YOU SWEAT.**

For detailed video instructions please visit javybirdsport.com/support/

Please refer to the safety warnings for important product safety information prior to installation or use of the product.

IN THE BOX

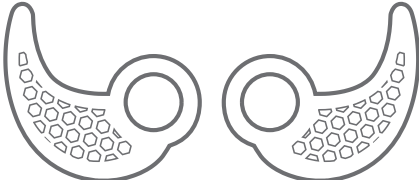
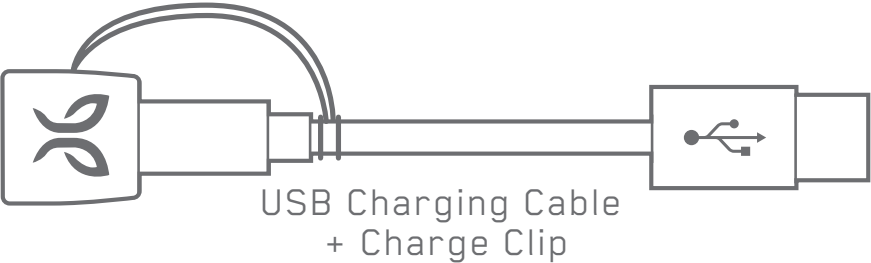
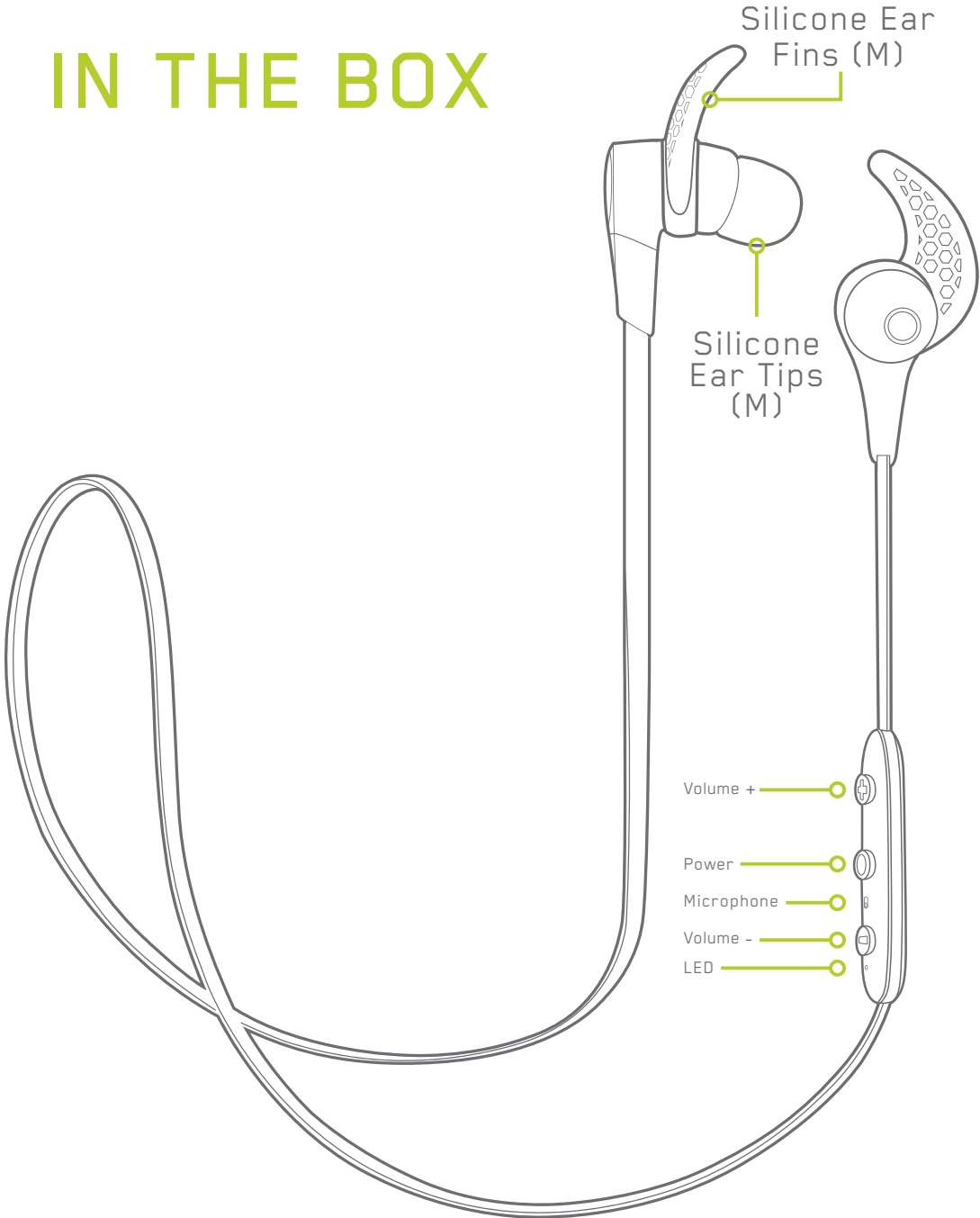

Comply™ Isolation Ear Tips (S, M, L)



Shirt Clip



Cord Clips



Silicone Ear Tips (S, L)



Carry Pouch



CHARGING/BATTERY STATUS

We recommend you charge your buds through any 5V 500mA USB power source. Wall/car adapters/chargers that supply more than 5.5 Volt will damage your Jaybird buds and should not be used.

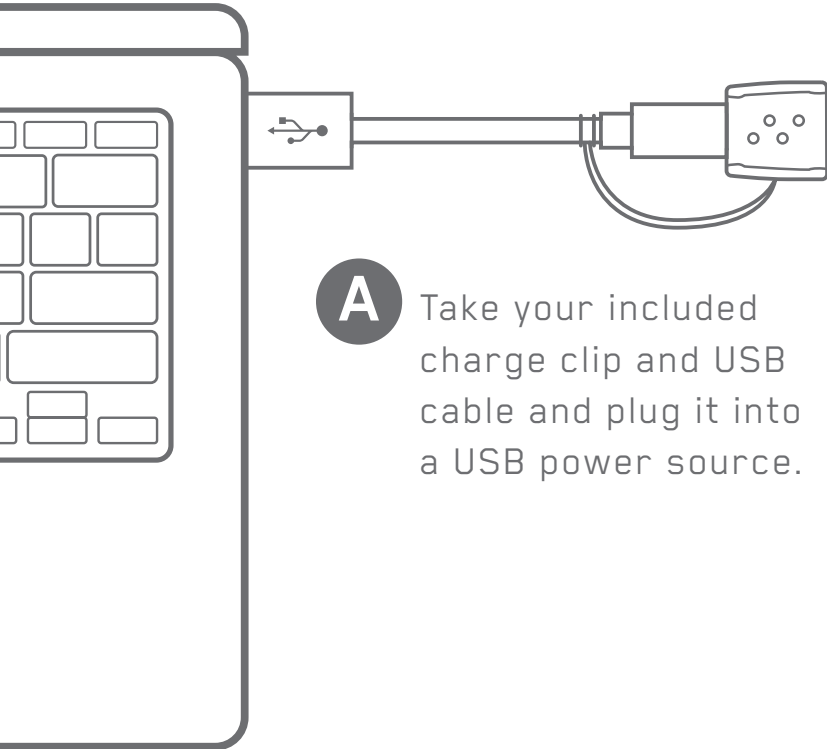

A Take your included charge clip and USB cable and plug it into a USB power source.

B The red LED will show when charging, and will turn to green when fully charged.

2.5 hours charging gives **8 hours** of playtime.

20 mins charging gives **1 hour** of play time.

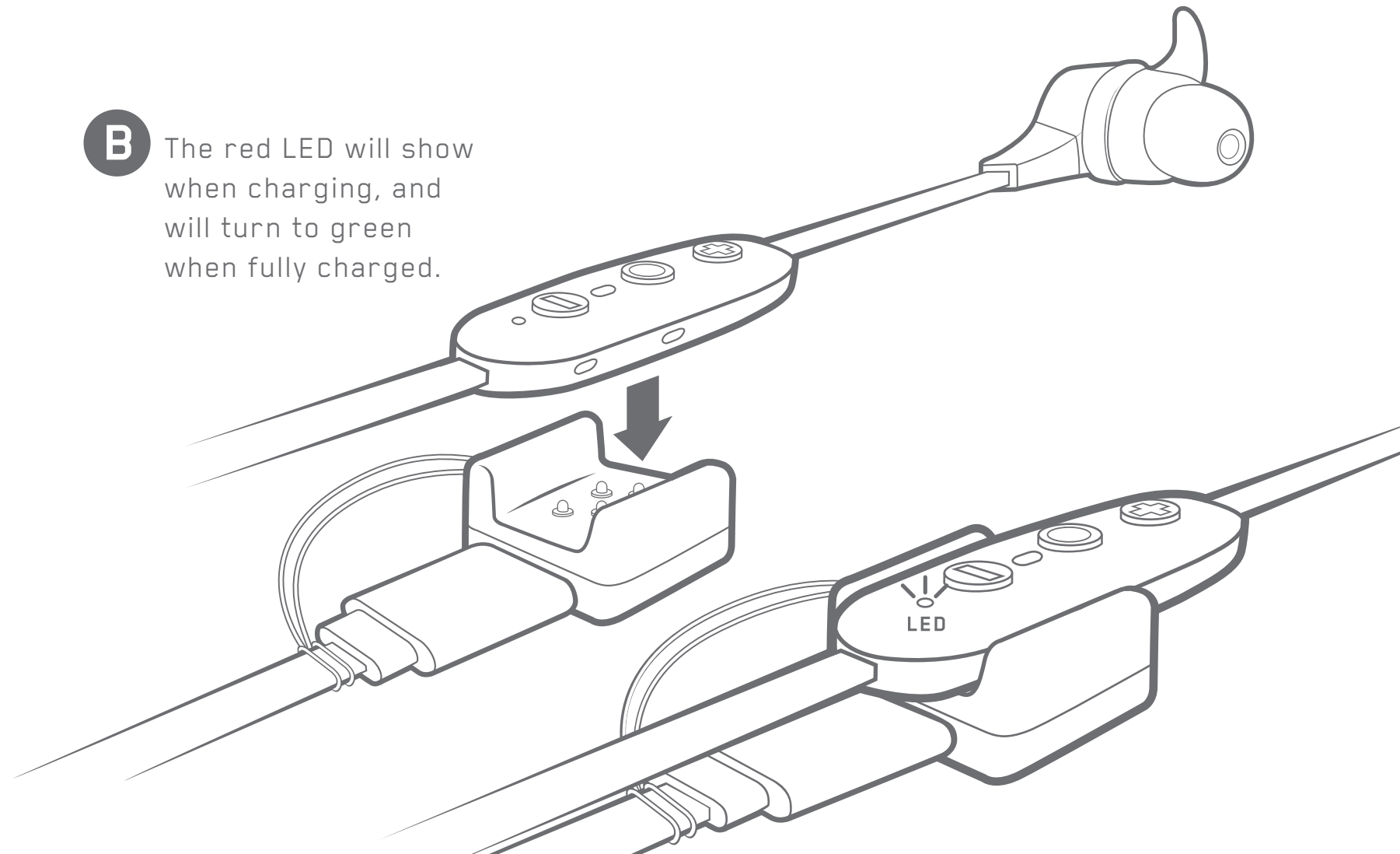

CHARGING/BATTERY STATUS

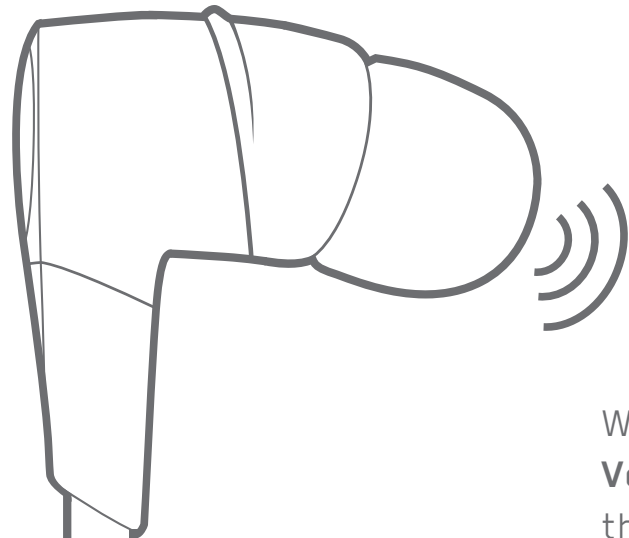

When not playing music, pressing **Volume +** or **Volume -** will announce the battery level.*

The LED will indicate a single green flash for more than 10% battery remaining and a single red flash when below 10%.

Your phone and the MySound App will also indicate battery status.

*Standby Mode: Powered and not playing music or on a phone call.

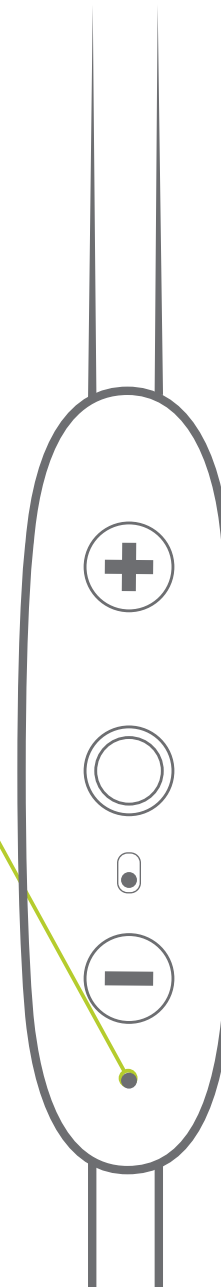

PAIRING

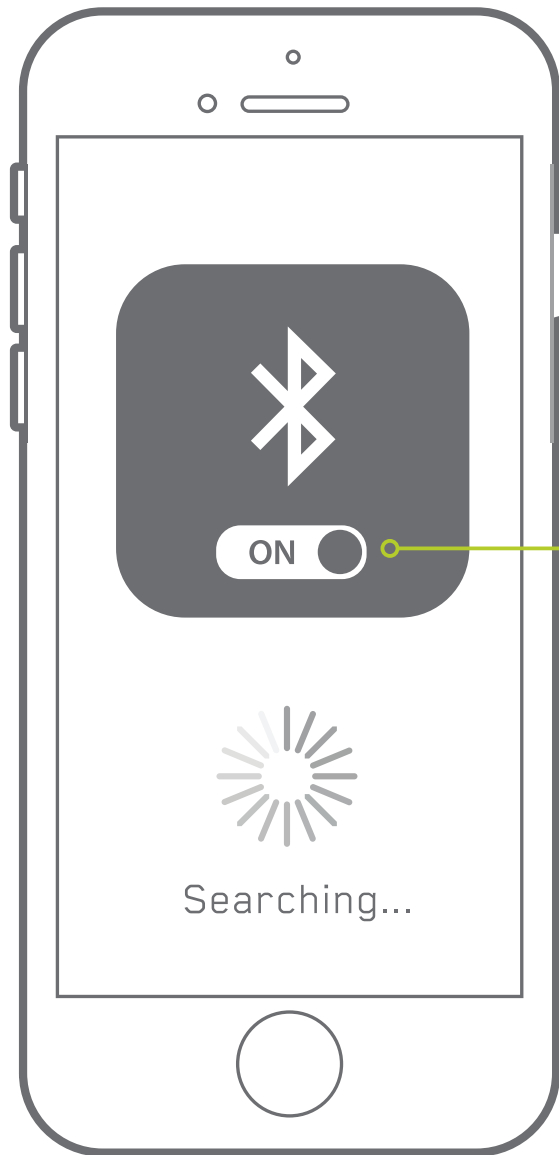

A On your phone/music device, turn Bluetooth on and ensure it is actively searching for Bluetooth devices.

B With your X3 turned off, press and hold the **Power Button** until you see the LED flashing red/green. A voice prompt will say "**SEARCHING FOR YOUR MUSIC DEVICE**"

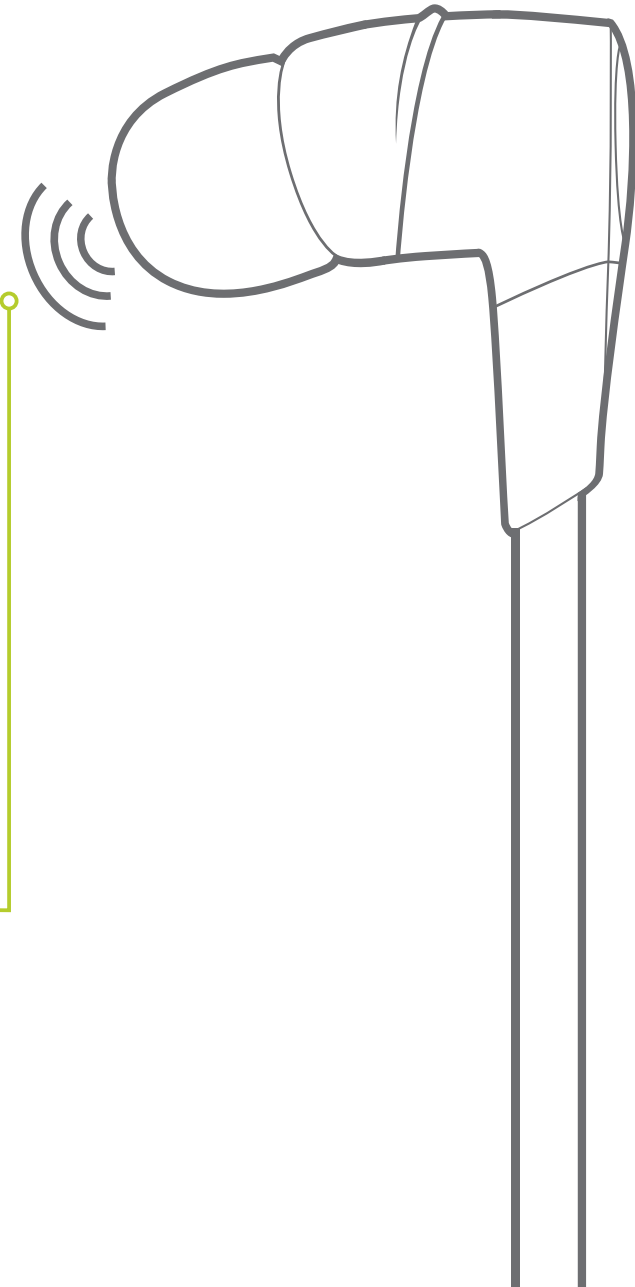

PAIRING

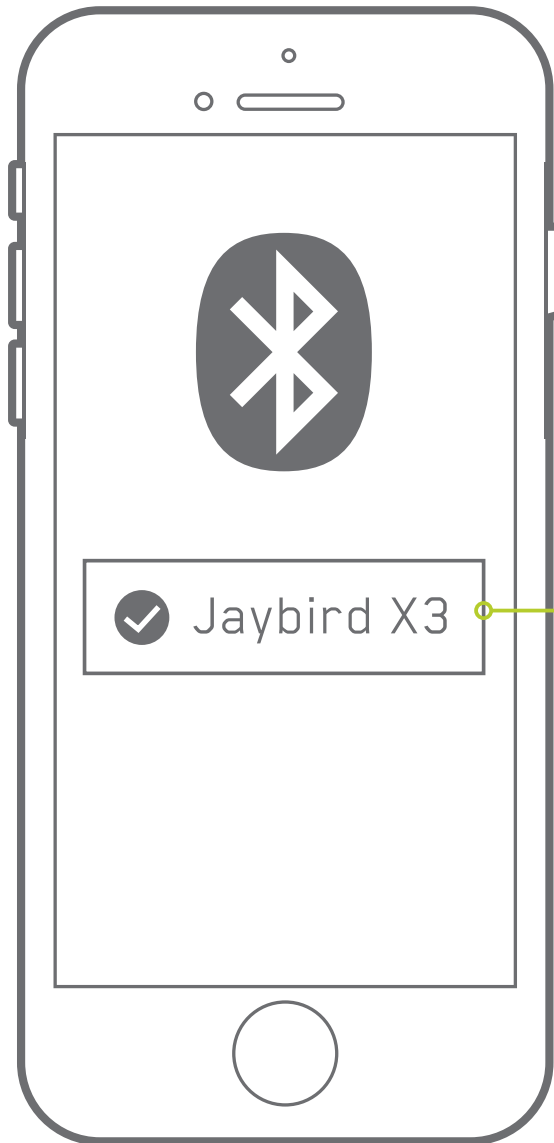

C Select "Jaybird X3" in the list of discovered devices.

D X3 voice prompt will say: **"HEADPHONES CONNECTED"**.
You are now ready to listen to your music

If the pairing is not successful, switch off your buds by pressing the **Power Button** until you hear **"POWER OFF"** and repeat the steps outlined above.

NOTE: When you turn your X3 buds on for the first time or after a reset, they will be in pairing mode.

FINDING YOUR PERFECT FIT

CHOOSING YOUR SETUP BASED ON USE

We recommend choosing a fit based on how you plan to use your Jaybird X3.

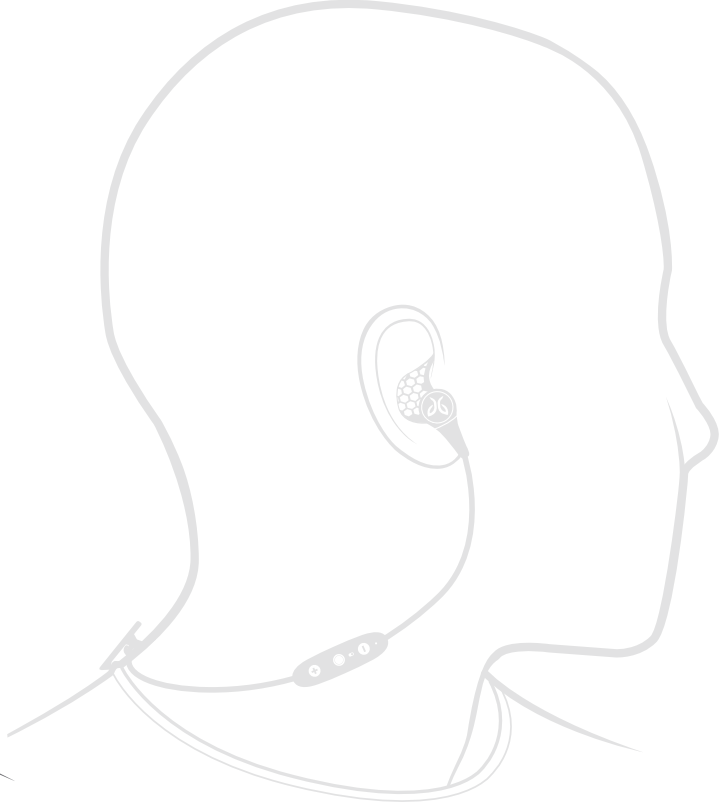
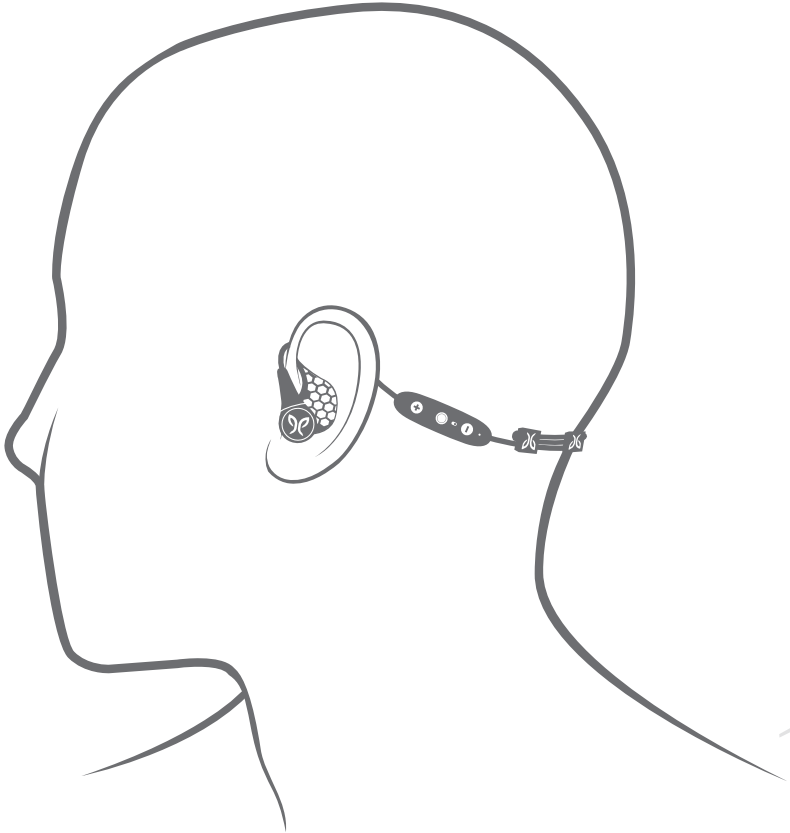



FINDING YOUR PERFECT FIT

1. SET UP YOUR FINS

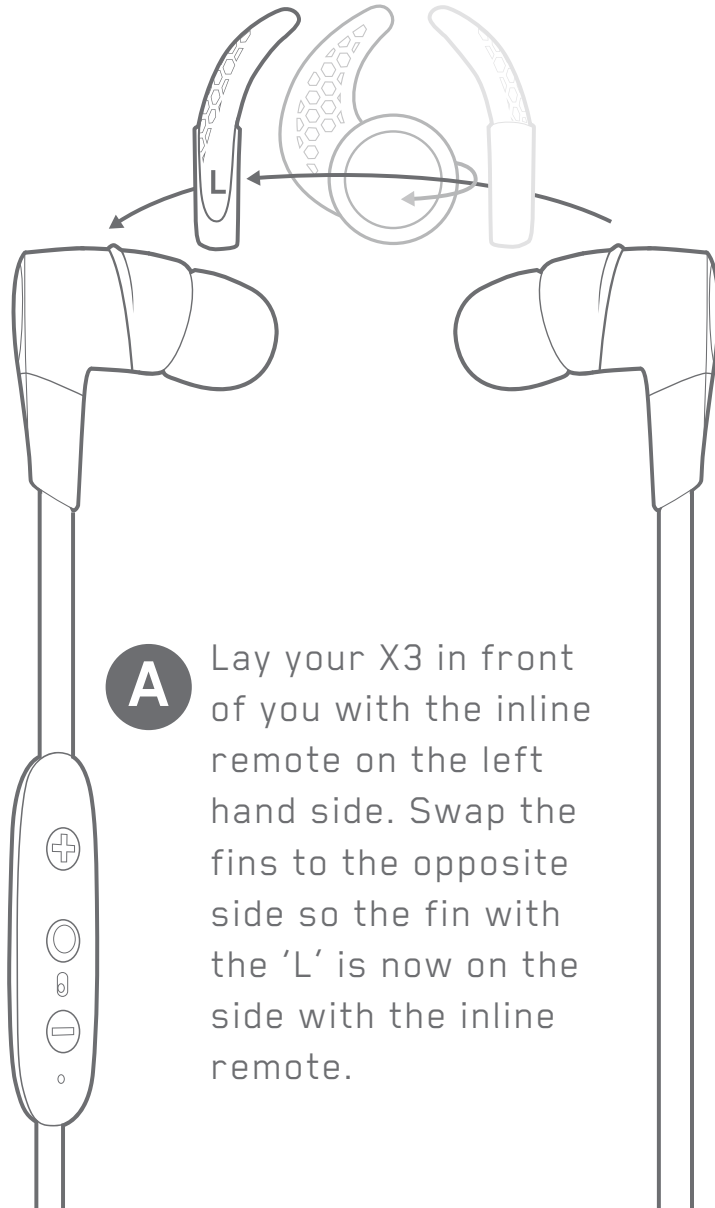

A Lay your X3 in front of you with the inline remote on the left hand side. Swap the fins to the opposite side so the fin with the 'L' is now on the side with the inline remote.

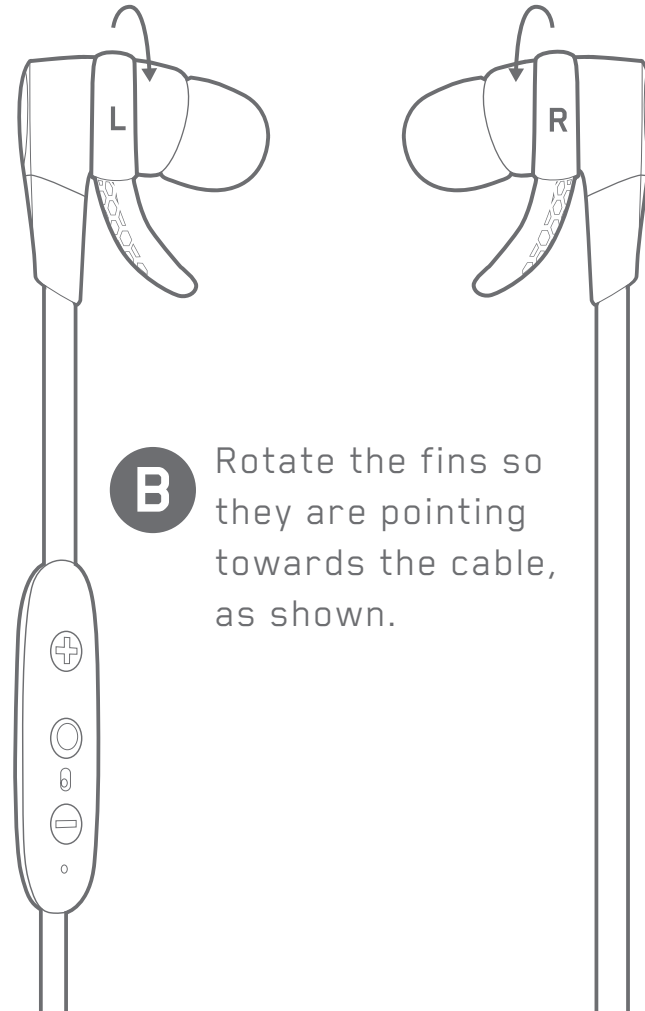

B Rotate the fins so they are pointing towards the cable, as shown.

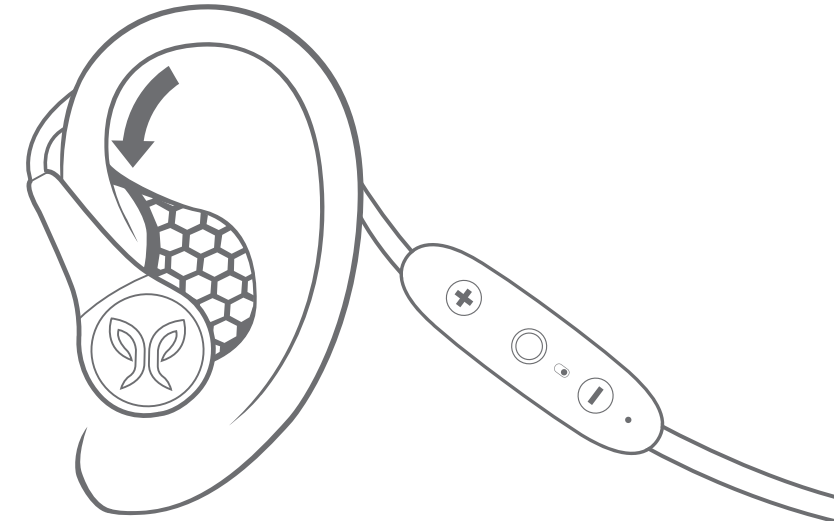

C Place your X3 over your ear with the inline remote on your left side.



FINDING YOUR PERFECT FIT

2. FINDING THE RIGHT SIZED TIPS AND FINS

A Starting with the medium-sized tips and fins attached, try placing your buds firmly within your ear while in the over-ear position.

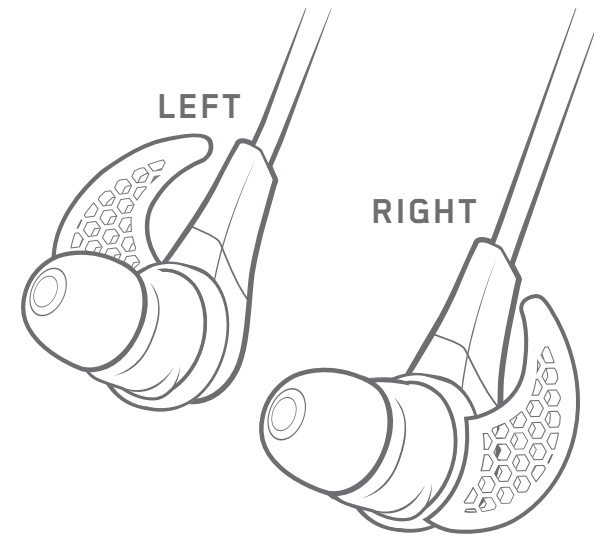

B If your buds are not comfortable, or feel loose, try alternative sized tips and/or fins. You can also try the Comply™ foam tips or remove the fins completely. **Be patient, it may take some time to get the perfect fit.**

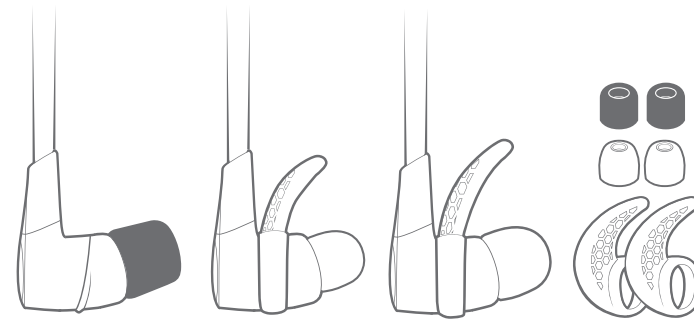

C Once you are happy with the fit, move onto step 3.

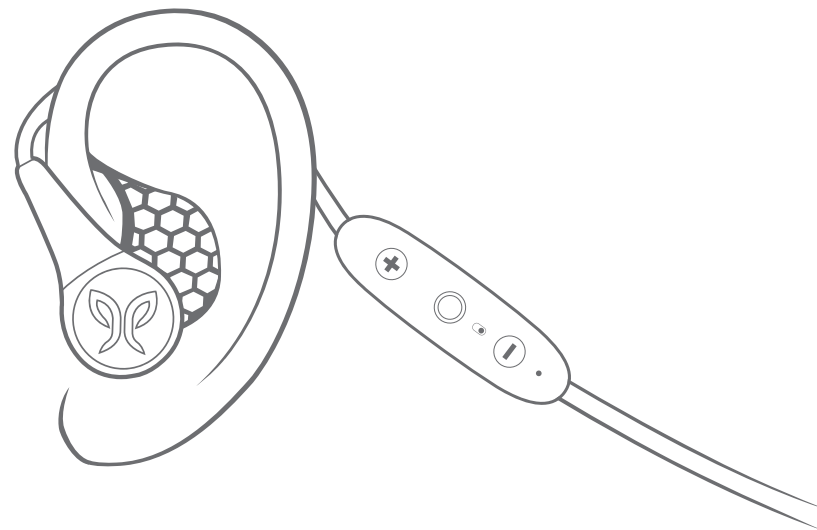

FINDING YOUR PERFECT FIT

3. CORD CLIPS

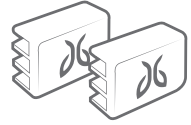

A Lay your X3 in front of you and fit the cord clips as shown.

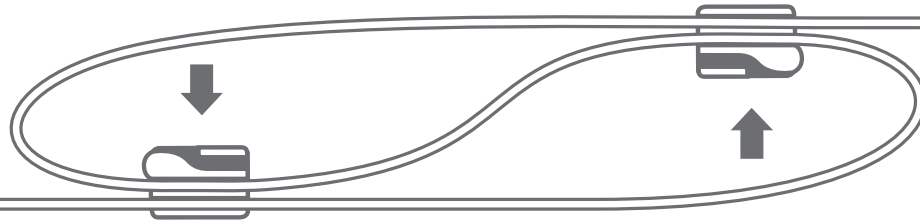

B Find the right cord length to get a snug fit, with no excess slack, around the back of your head by pulling the top and bottom cord outwards.

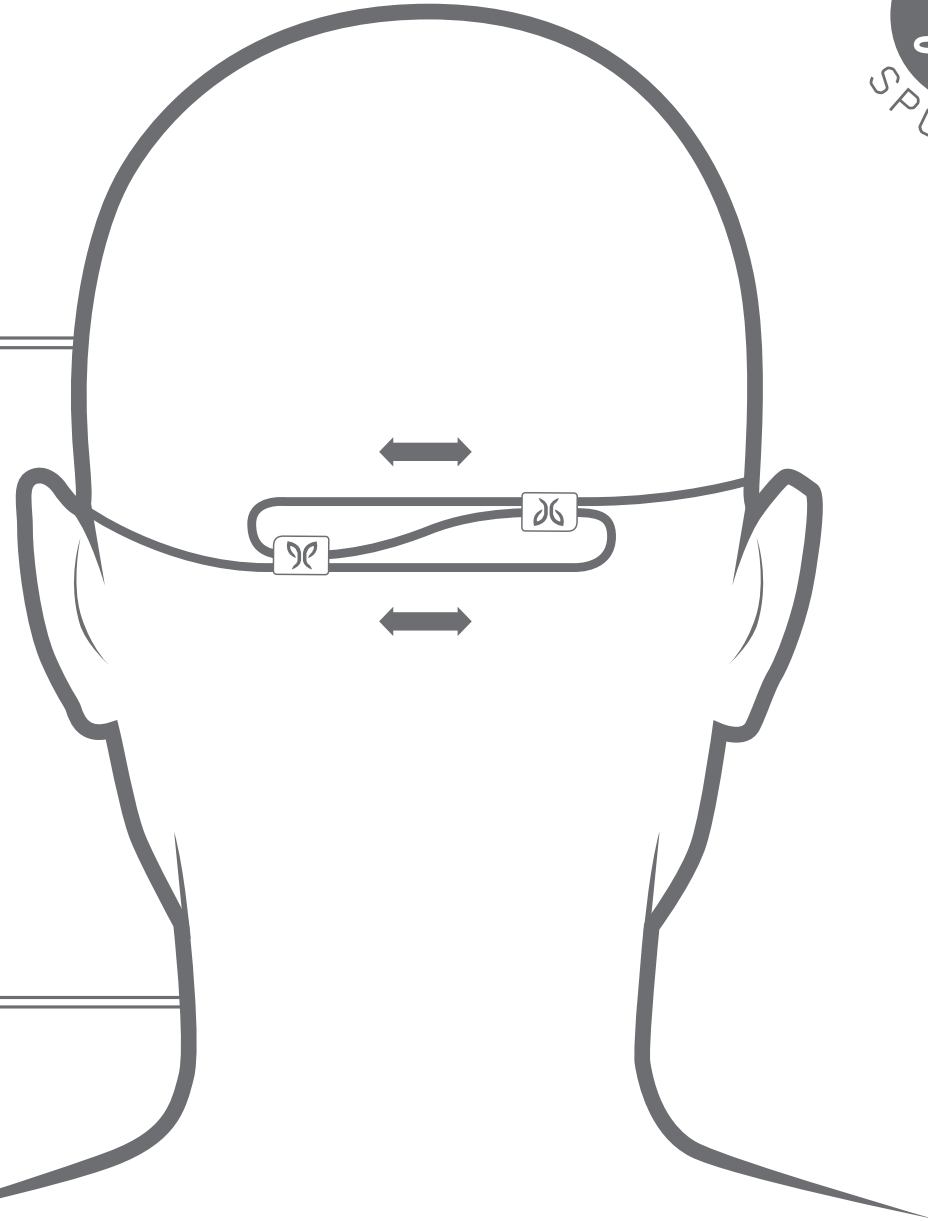

C Insert the last loop into the cord clip and pull firmly.



FINDING YOUR PERFECT FIT

If you intend to use Jaybird X3 for casual use, we recommend the under-ear setup.

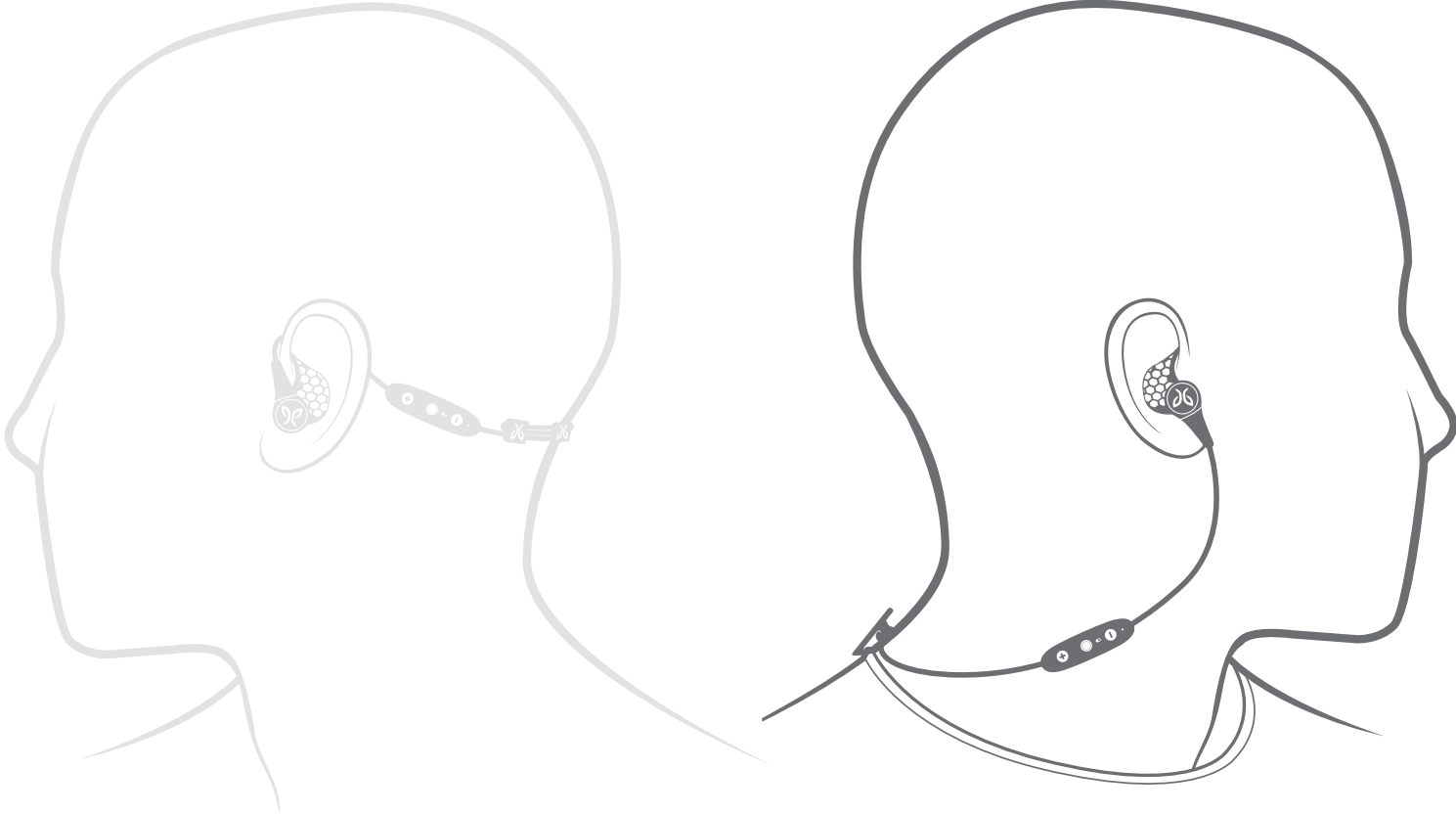



FINDING YOUR PERFECT FIT

1. FINDING THE RIGHT SIZED TIPS AND FINS

A With the medium-sized tips and fins attached, place your buds firmly within your ear while in the under-ear position. The inline remote should be on the right side.

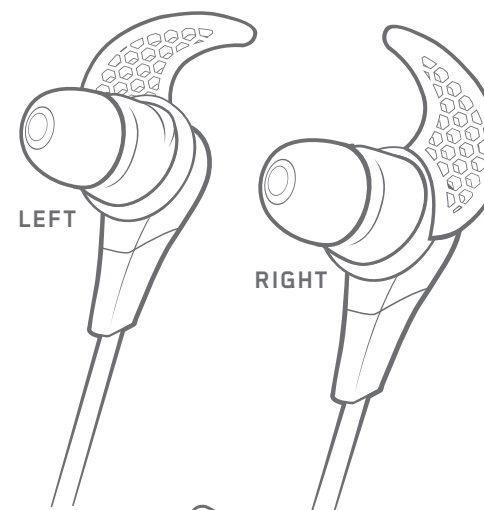

B If your buds are not comfortable, or feel loose, try alternative sized tips and/or fins. You can also try the Comply™ foam tips or remove the fins completely. **Be patient, it may take some time to get the perfect fit.**

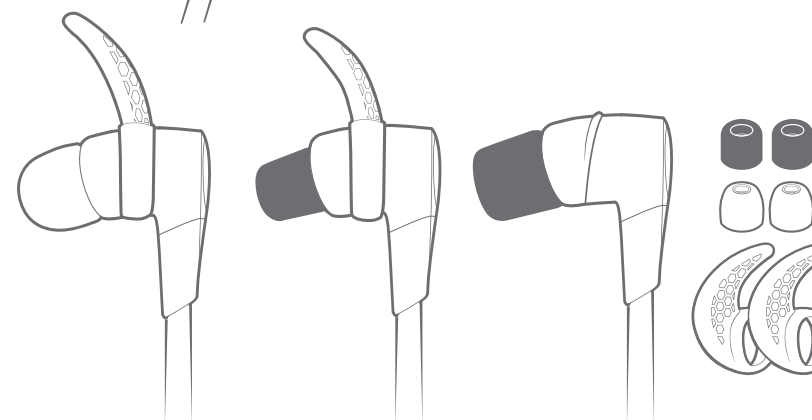

C Once you are happy with the fit, you are good to go.

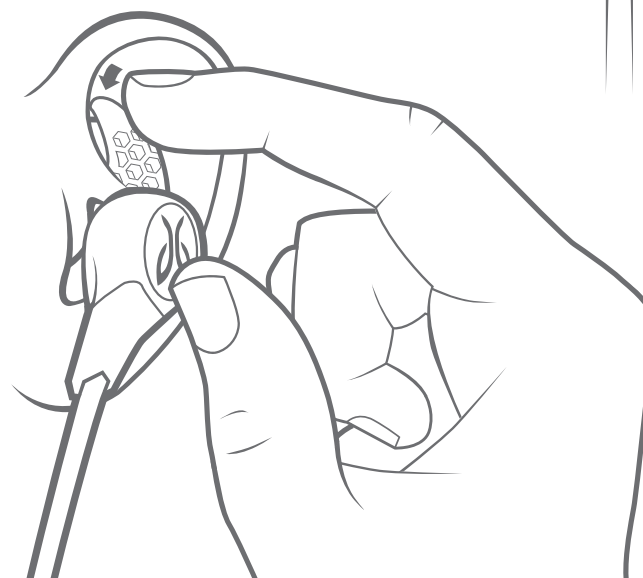



FINDING YOUR PERFECT FIT

2. SHIRT CLIP

Use the included Shirt clip To secure your X3 buds to the back of your shirt.

Long side of the clip on the outside of the shirt.

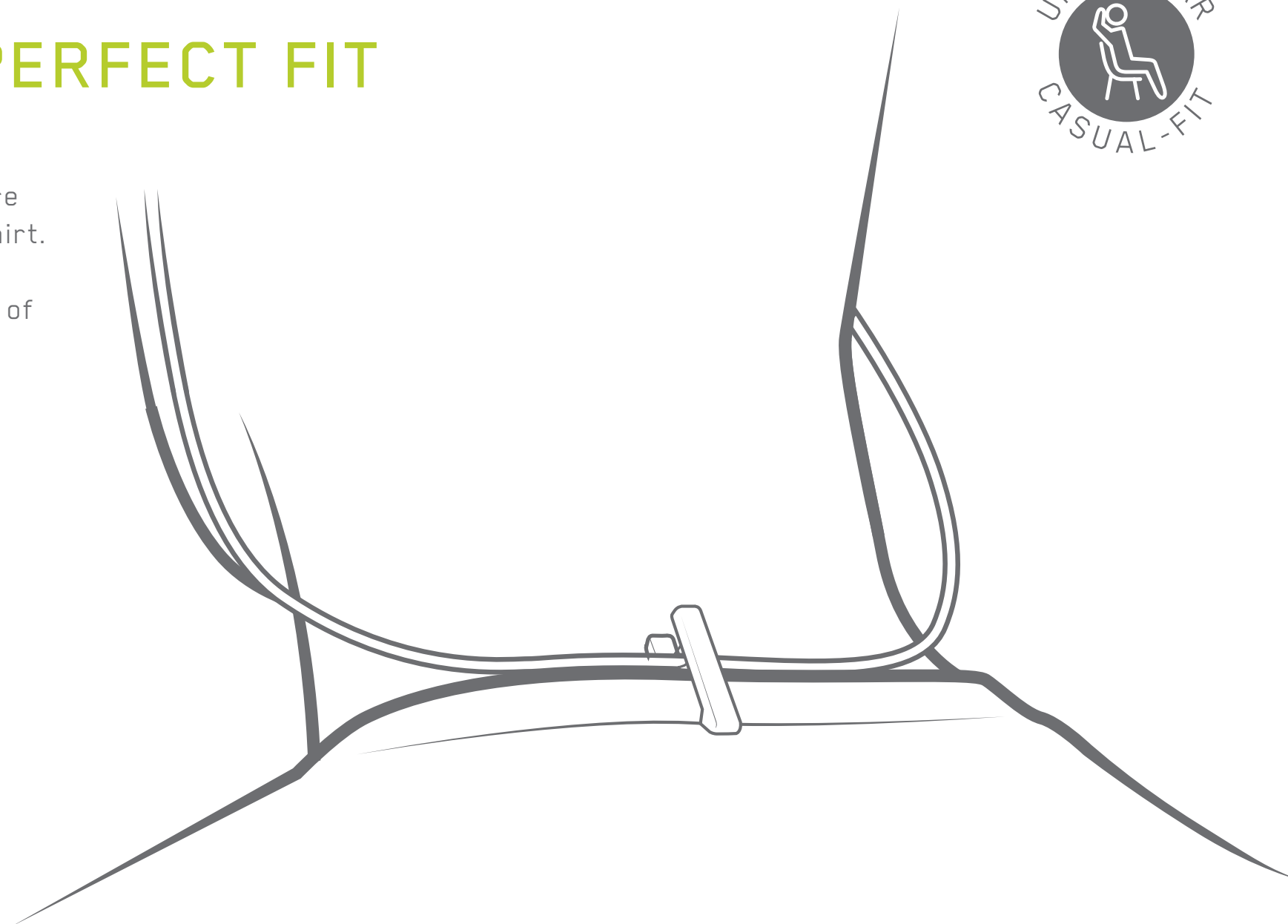
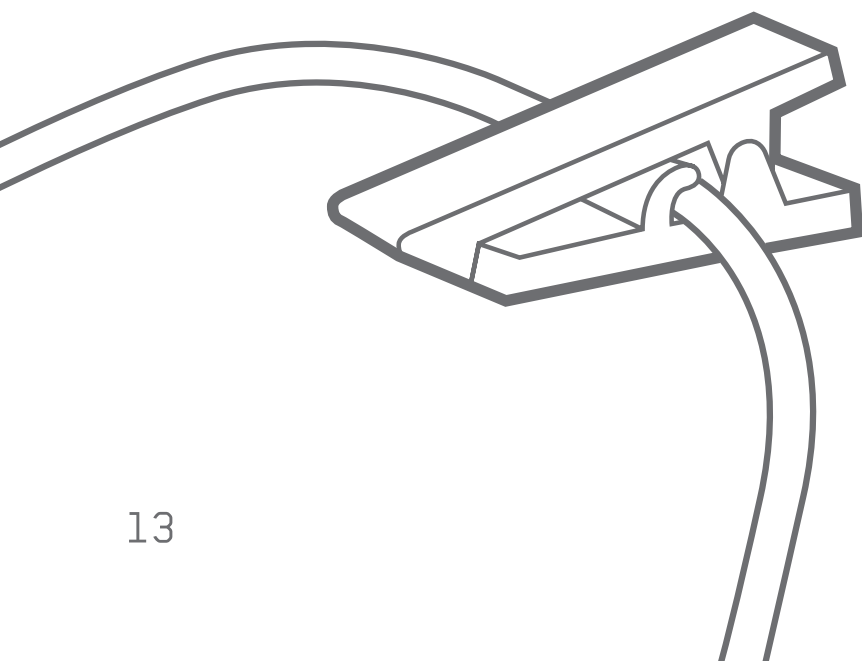

DETAILED INSTRUCTIONS

BUTTON FUNCTIONALITY

 4 SEC PRESS

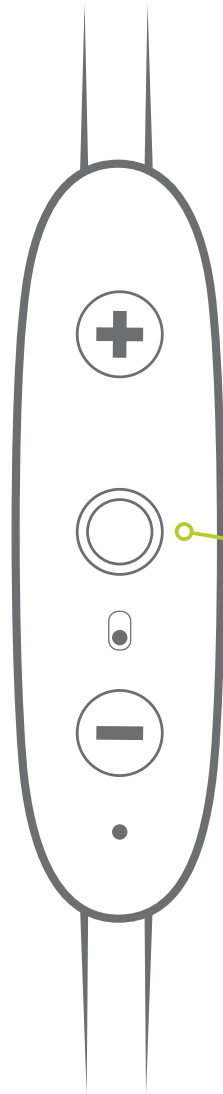

 ON/OFF

To turn X3 on or off, press and hold the **Power Button** for about 4 seconds. A voice prompt will say “**POWER ON**” or “**POWER OFF**”.

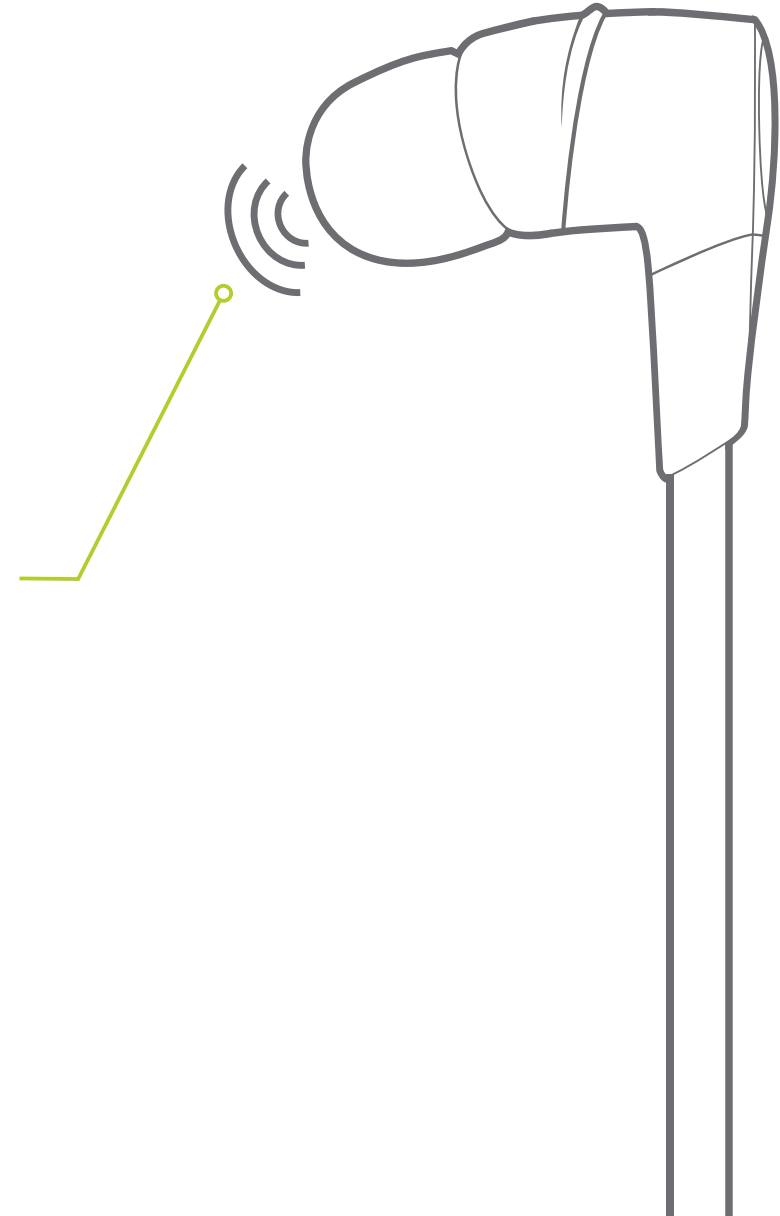

DETAILED INSTRUCTIONS

PLAYING MUSIC

● SHORT PRESS ● 1 SEC PRESS

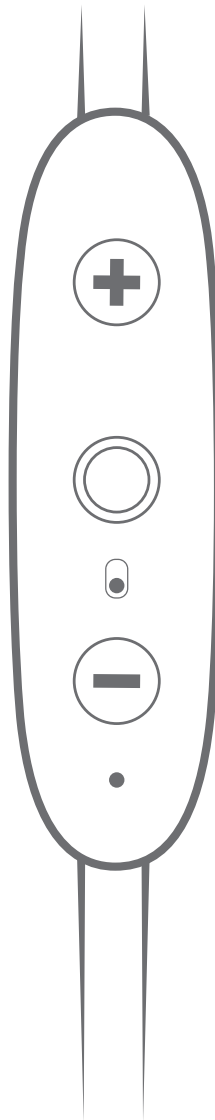

- VOLUME + ● SKIP FORWARD
- PLAY / PAUSE ● VOICE COMMANDS
- VOLUME - ● SKIP BACKWARD

Play or pause, a song or video with a short press and release of the **Power Button**.

To skip a song, press the **Vol. +** button for 1 second.

To go backwards, press the **Vol. -** button for 1 second.

To change the volume + or -, short press the **Vol. +** or **Vol. -** button

To activate voice commands, (Siri or Google Now), press the **Power Button** for 1 second.

DETAILED INSTRUCTIONS

● SHORT PRESS ● 1 SEC PRESS ●● DOUBLE PRESS

PHONE CALLS

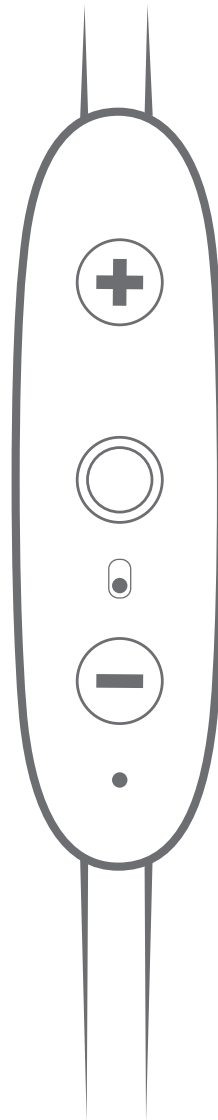

● SWITCH A CALL

● ACCEPT A CALL ● 1 SEC PRESS DECLINE A CALL ●● REDIAL

● MUTE / UNMUTE

Accept a phone call, with a short press of the **Power Button**.

To decline a phone call, press the **Power Button** for 1 second.

To mute or unmute, a call press the **Vol. -** button for 1 second.

To redial, a phone number you can double press the **Power Button**.*

To switch a call from your phone speaker to your X3 buds short press the **Vol. +** button.

*Standby Mode: Powered and not playing music or on a phone call.

DETAILED INSTRUCTIONS

THE MYSOUND APP

MySound lets you customize the sound profile on your X3 buds.



Your new sound settings are saved right on your buds, so you can take your custom sound with you no matter where you go with any device you use.

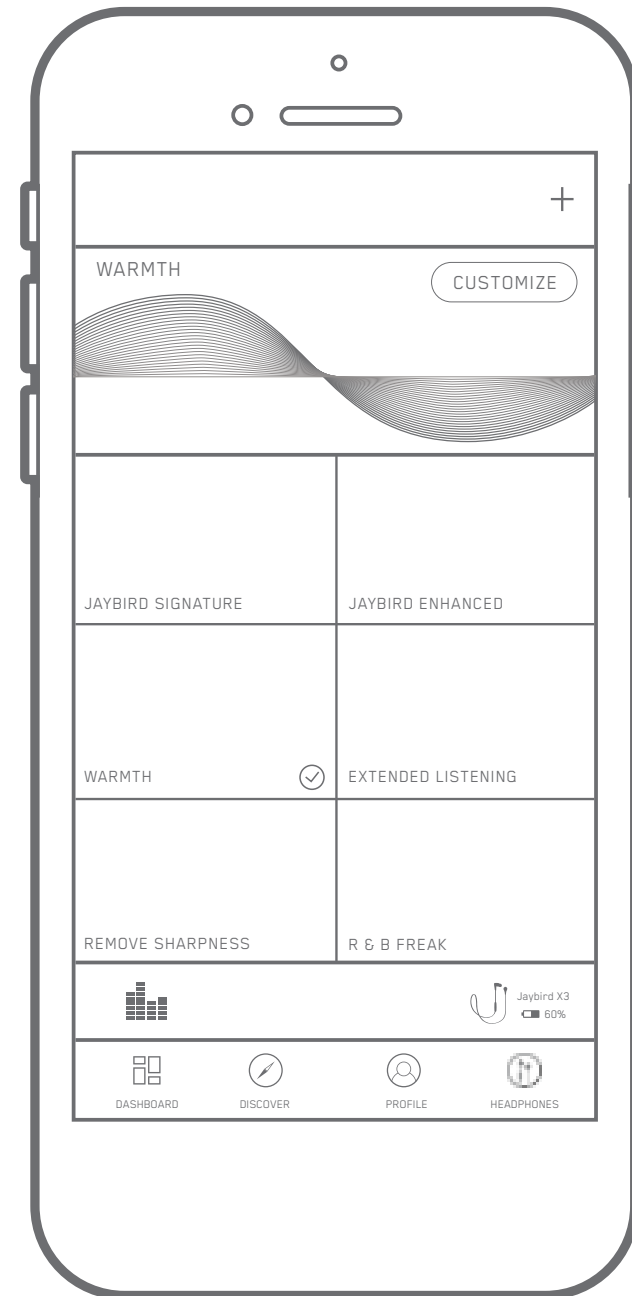

DETAILED INSTRUCTIONS

THE MYSOUND APP

NOTE: The MySound app works with Jaybird X3 and Freedom. Other manufacturers and older Jaybird buds are not supported.

Adding additional bass to your sound profile through the MySound app will reduce play time.

SOUND
Customize your sound settings. Changes are saved to your X3 buds.

MUSIC
Indicates if music is playing on your device.

DISCOVER
Discover presets from athletes and other users.

SAVE
Save your new preset to your dashboard for easy access to all your favorite sound settings.

HISTORY
Track through a history of your changes.

DEVICE
See your connected device and battery status.

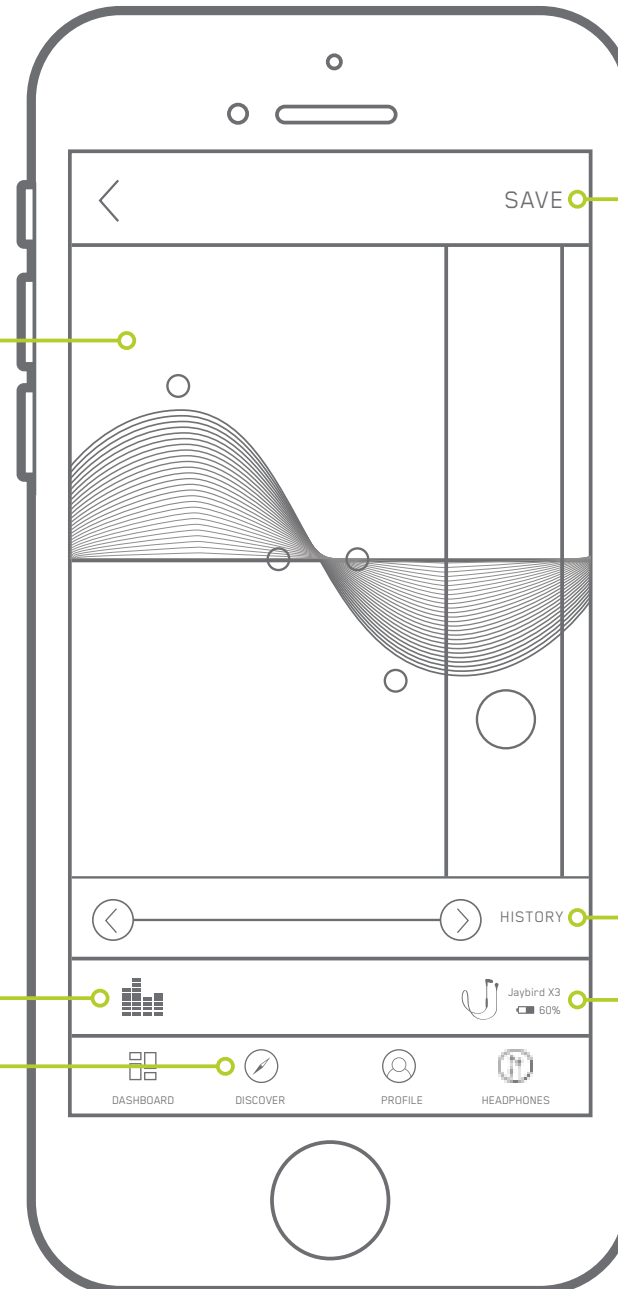

DETAILED INSTRUCTIONS

MULTIPOINT - CONNECTION TO MULTIPLE DEVICES

Multipoint allows you to be connected to two devices simultaneously. You can for instance be connected to your laptop and your mobile phone. While listening to music on your laptop you will be able to accept an incoming call on your phone.

- 1** Ensure your X3 buds are paired and connected to both devices. Follow pairing instructions on page 5-6.
- 2** Make sure that only the two devices you want to connect to are turned on and in proximity.

Your X3 can remember up to eight paired Bluetooth® devices and can be actively connected two devices at a time.

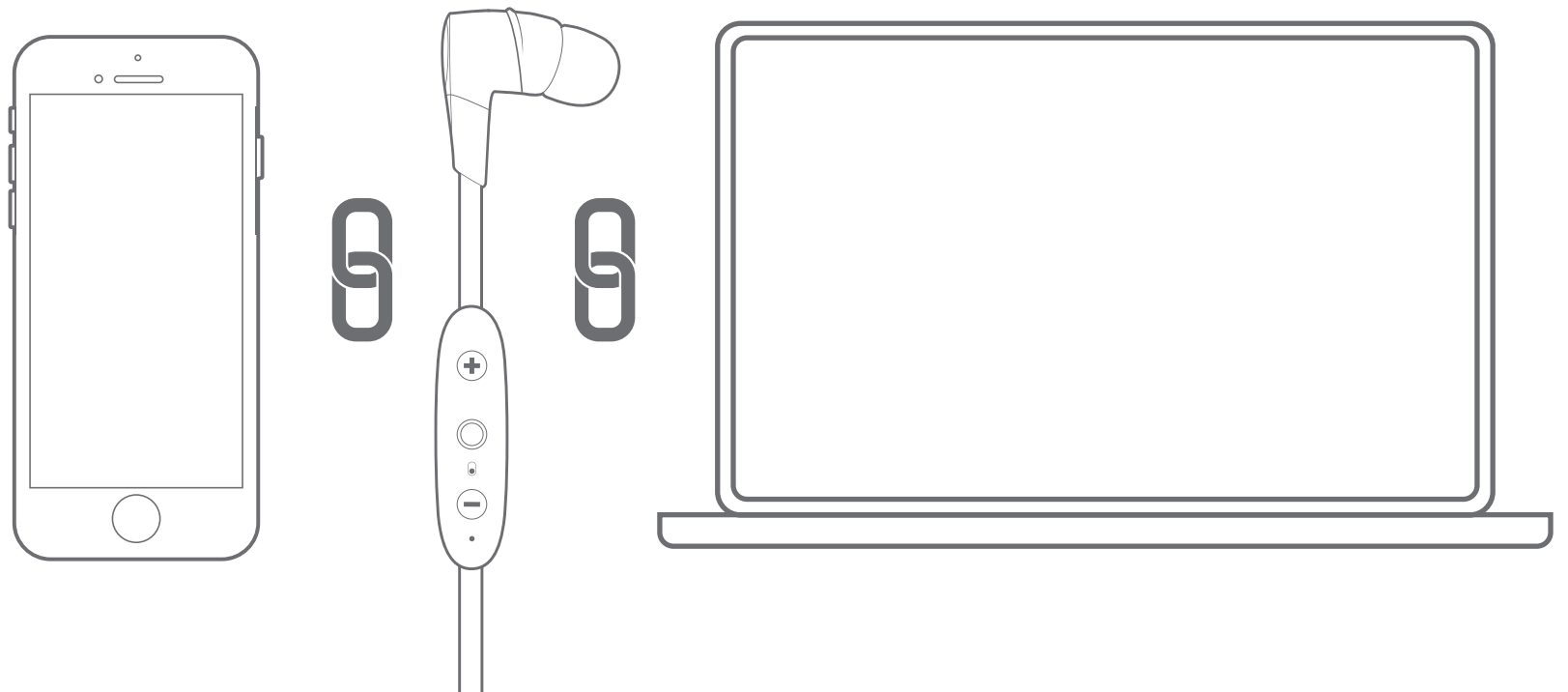

DETAILED INSTRUCTIONS

SHARE ME

The ShareMe feature allows you to share the music you are listening to with another pair of X3 buds.

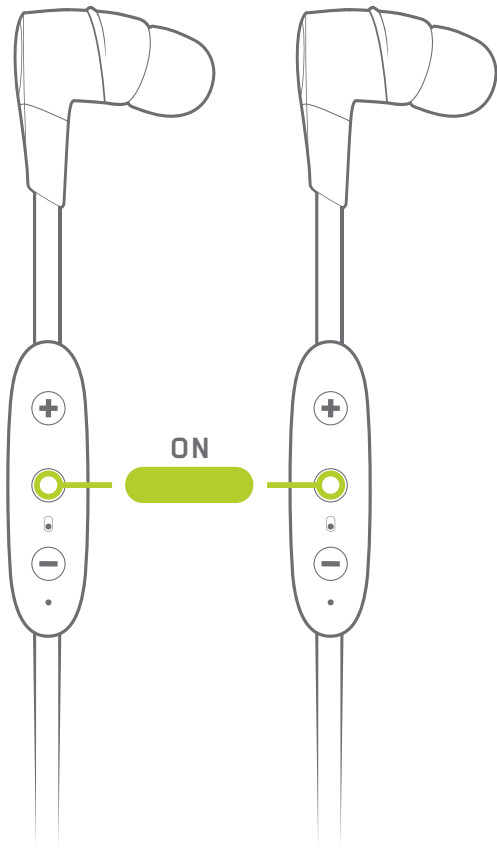

A Power on both pairs of X3 buds.

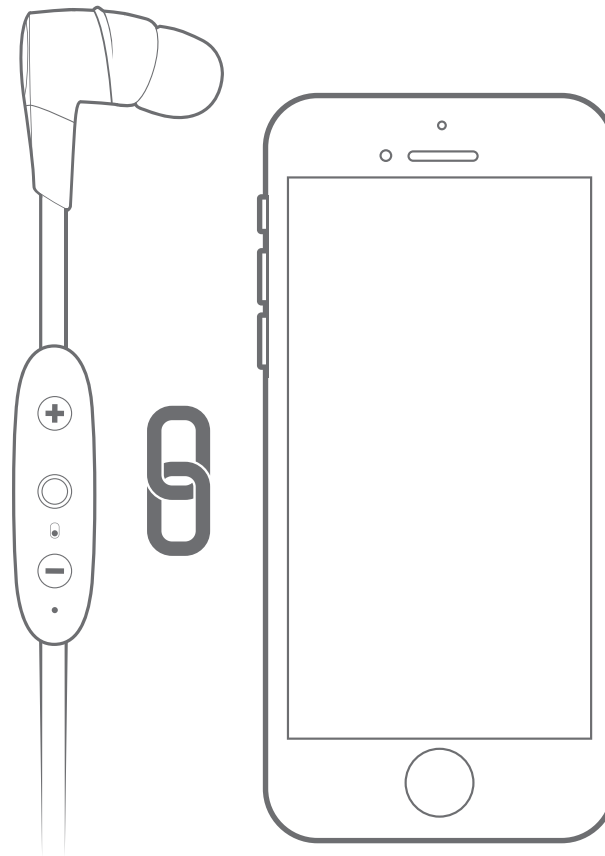

B Only connect one device to your music device. Ensure the second device is not connected to any Bluetooth device.

DETAILED INSTRUCTIONS

SHARE ME

The ShareMe feature allows you to share the music you are listening to with another pair of X3 buds.

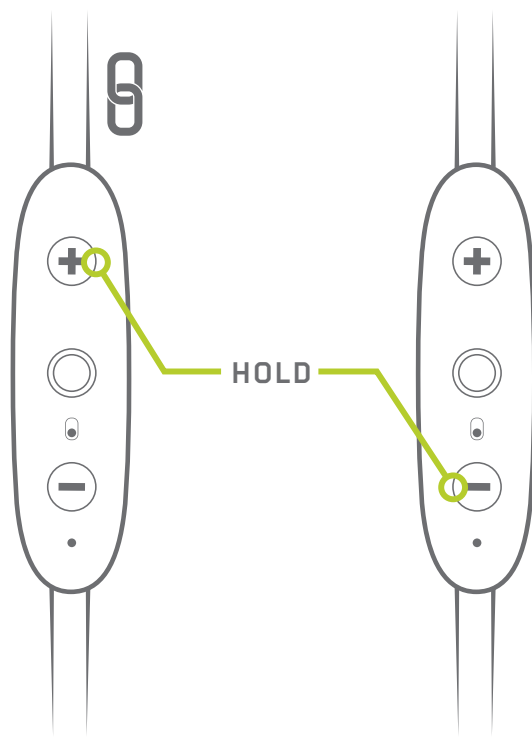

- C** Press and hold 'VOL +' on the connected buds, while you press and hold the 'VOL -' on the second buds until the LEDs on both buds are flashing red/green.

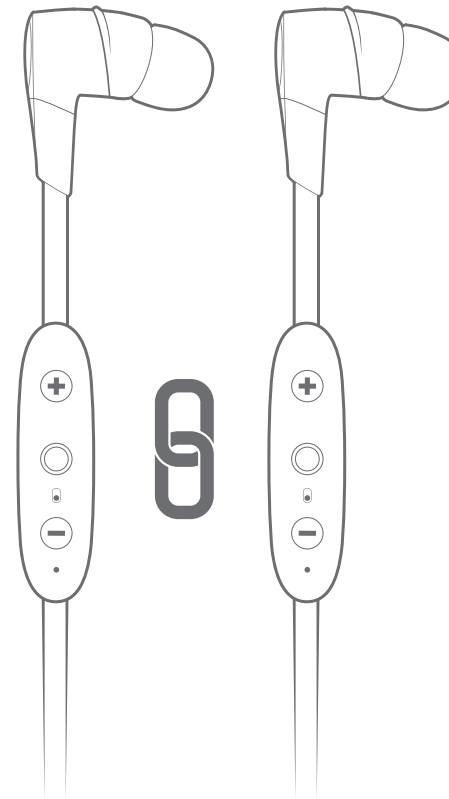

- D** Both buds will be connected when the LEDs stop flashing and you will hear 'Headphones Connected'. Play some music and enjoy the shared experience.

DETAILED INSTRUCTIONS

SMARTWATCHES

With the right smartwatch you can leave your phone at home. Just sync music to your smartwatch and pair X3 to your smartwatch. Use your smartwatch user manual for instructions on how to pair a Bluetooth device.

Apple WatchOS

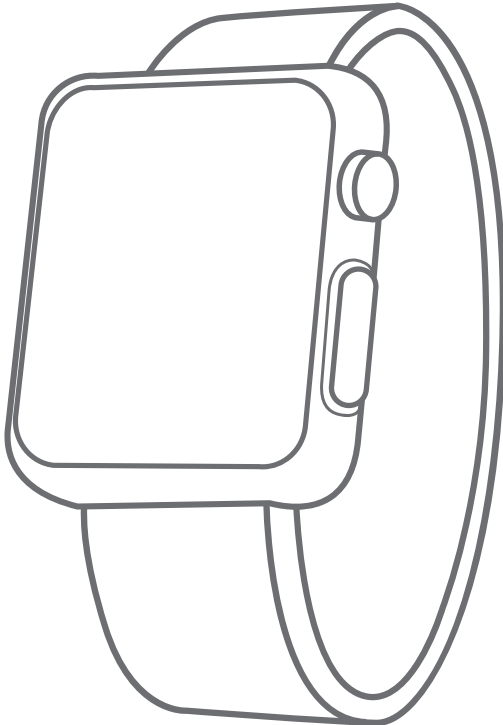

Samsung Tizen

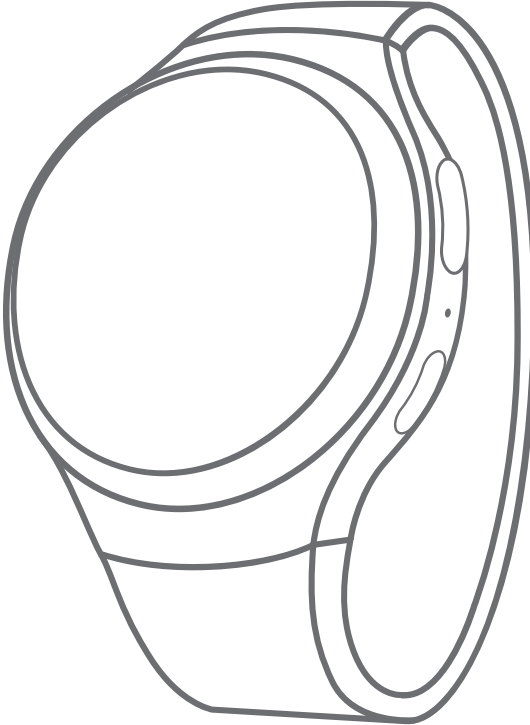

Android Wear

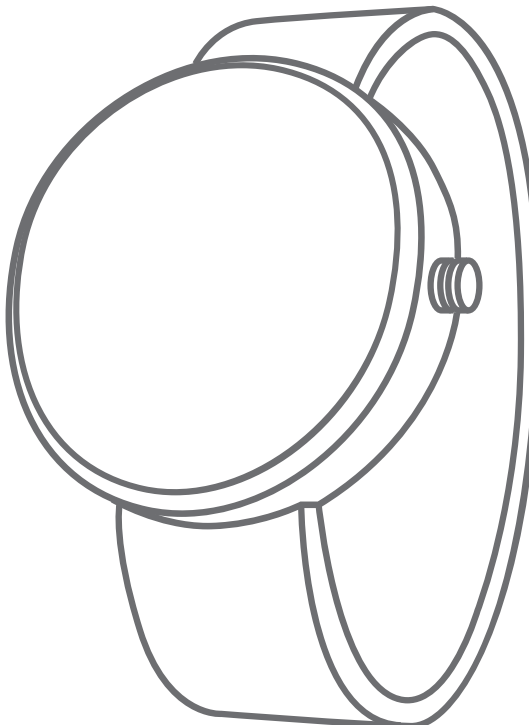

TROUBLESHOOTING

If your buds are not responding, connect the charge clip and USB cable to a power source. This will turn your buds off and perform a soft reset.

If this does not resolve your problem we recommend to reset your buds to their original factory Settings.

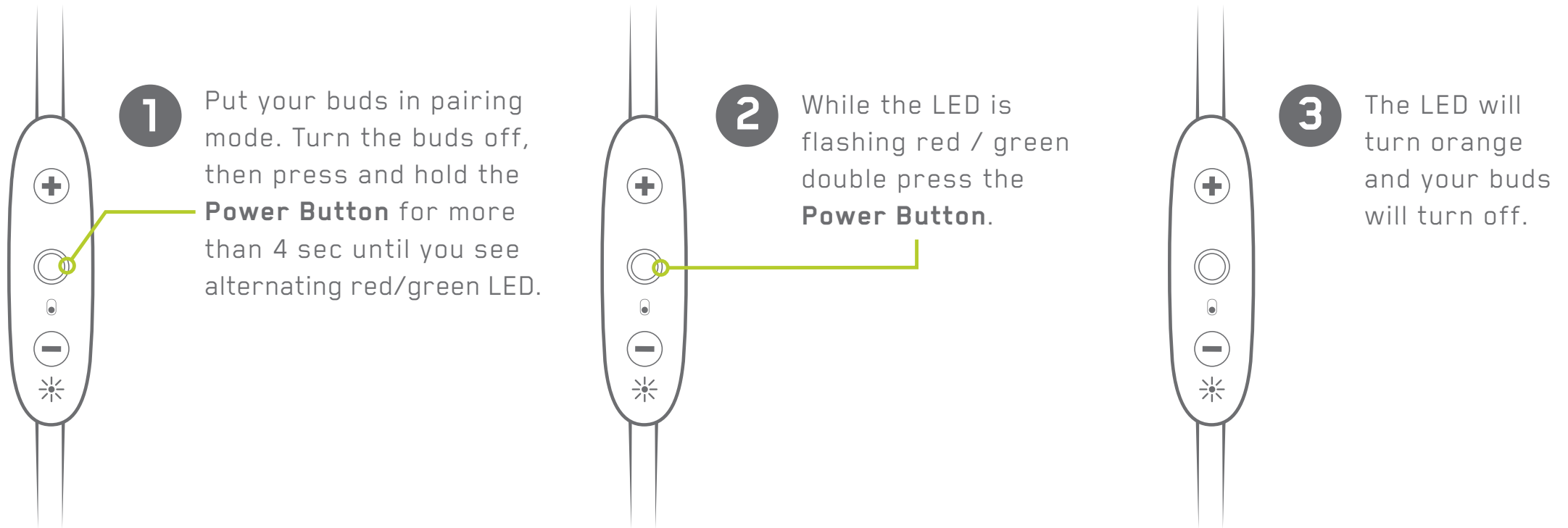

NOTE: Once your buds have been reset you will have to pair it again to your devices. Select **"FORGET"** or **"REMOVE"** Jaybird X3 from your device's Bluetooth menu. Follow the pairing instructions on page 5-6 to repair your devices.

SPECIFICATIONS

Bluetooth Version	4.1, Multipoint
Codec	AAC, SBC, Modified SBC
Profile	Handsfree, Headset, A2DP, AVCRP, SPP
Effective Range	10 meters (30 feet)
Play Time	8 Hrs*
Standby Time	110 Hrs*
Power	Bluetooth headset: 5.0V  , 0.5A
Charging Time	2.5 Hrs
Quick Charge	20 Min = 1 Hr play time
Dimensions	27 x 24 mm earbud size, 490 mm cord length
Weight	Approx 13 g

*Play time and standby time may vary due to usage conditions. Adding additional bass to your sound profile through the MySound app will reduce play time.

WARRANTY, WARNINGS & SAFETY

Full warranty, care & maintenance details at:
jaybirdsport.com/warranty +1.866.244.3399

WARNING: Due to the isolating characteristics of these headphones do not use while driving, riding a bike or where vehicular traffic is present, or in any other activity where failure to hear surrounding sounds could be dangerous. Use of these headphones at excessive volumes may cause permanent hearing damage. Always turn the volume down before use. Take caution in regards to inserting objects into ear canal, use at own risk. Do not wear the device while it is connected to a power source driven from main 110V or 220V lines.

Copyright 2016 Jaybird, LLC. All rights reserved. Jaybird, and the Jaybird logo are trademarks of Jaybird, LLC. Bluetooth is a trademark owned by Bluetooth SIG, Inc. USA, and licensed to Jaybird, LLC. iPhone, iPad and iPod are trademarks of Apple, Inc., registered in the US and other countries and App Store is a service mark of Apple Inc. All other trademarks are the property of their respective owners. Android is a trademark of Google Inc. in the United States and other countries. Manufactured under Freebit patent numbers EP2177045, US8630436, US8976995 and corresponding international patents. Assembled in Malaysia.

EARTIP CLEANING

Keeping your Jaybird Buds eartips clean is essential for safe, hygienic use.

IMPORTANT: DO NOT attempt to clean the eartips without first removing them from the headphones. Getting the delicate circuitry inside your Jaybird Buds wet may cause permanent damage.

1. Firmly grip the eartip with one hand and the earphone with the other. Carefully remove the eartip from the bud.
2. Use warm water and mild soap on a damp cloth to remove dirt and earwax from the eartip. Do NOT use harsh cleaning agents.
3. Rinse and completely dry your eartip before placing them back on your buds.
4. Carefully push the eartips back onto the buds.

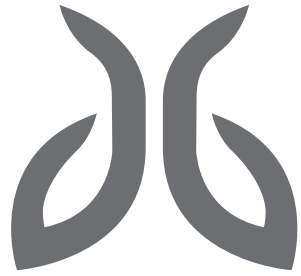

LISTEN RESPONSIBLY

Avoid excessive volume levels and prolonged periods of listening. Prolonged listening at excessive volume levels may cause permanent hearing disability.

Do not use around road traffic.

Video instructions at [jaybirdsport.com](https://www.jaybirdsport.com)