

MANUALE D'USO

MACCHINA DA CAFFÈ

IT

INSTRUCTION MANUAL

COFFEE MACHINE

EN

MANUEL D'UTILISATION

MACHINE À CAFÉ

FR

GEBRAUCHSANWEISUNG

KAFFEEMASCHINE

DE

GEBRUIKSAANWIJZING

KOFFIEMACHINE

NL

MANUAL DE USO

CAFETERA

ES

MANUAL DE UTILIZAÇÃO

MÁQUINA DE CAFÉ

PT

BRUKSANVISNING

KAFFEMASKIN

SV

РУКОВОДСТВО ПО ЭКСПЛУАТАЦИИ

КОФЕВАРОЧНАЯ МАШИНА

RU

BRUGERVEJLEDNING

KAFFEMASKINE

DA

INSTRUKCJA UŻYTKOWNIKA

EKSPRES DO KAWY

PL

KÄYTTÖOPAS

KAHVINKEITIN

FI

BRUKERHÅNDBOK

KAFFEMASKIN

NO

smeg

Dear Customer,

Thank you for purchasing this Smeg 50's Style coffee machine.

By choosing one of our products, you have selected an appliance which combines iconic style with innovative technical design and attention to detail.

A Smeg appliance coordinates perfectly with other Smeg products, or works equally great as a standalone statement piece in your kitchen.

We hope you enjoy using your new appliance!

For further information on the product, please visit www.smeg.com or www.smeg50style.com.

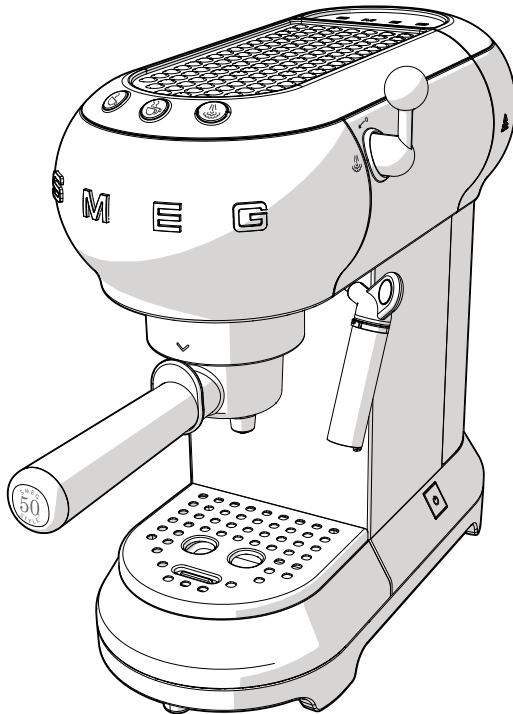

Model ECF01
Coffee Machine

Contents

1 Instructions	26
1.1 Introduction	26
1.2 This user manual	26
1.3 Intended use	26
1.4 General safety instructions	27
1.5 Manufacturer liability	29
1.6 Identification plate	29
1.7 Disposal	29
2 Description	30
2.1 Product description	30
3 Use	31
3.1 Before first use	31
3.2 First use	32
3.3 How to prepare espresso coffee	33
3.4 How to prepare a cappuccino	34
3.5 How to heat water	36
3.6 Accessing the settings menu and changing the settings	36
3.7 How to cool down the boiler	38
4 Cleaning and maintenance	39
4.1 Instructions	39
4.2 Cleaning the body of the coffee machine	39
4.3 Cleaning the coffee machine components	39
4.4 Descaling	41
4.5 What to do if...	42

We advise you to read this manual carefully, as it contains all the instructions for maintaining the appliance's aesthetic and functional qualities.

For further information on the product: www.smeg.com



Instructions

1 Instructions

1.1 Introduction

Key information for the user:

Instructions



General information on this user manual, on safety and final disposal.

Description



Appliance description

Use



Information on using your appliance.

Cleaning and care



Information for proper cleaning and maintenance of the appliance.



Safety instructions



Information



Advice

1.2 This user manual

This user manual is an integral part of the appliance and must therefore be kept in its entirety and in an accessible place for the whole working life of the appliance.

1.3 Intended use

- Use the appliance only indoors.
- This appliance has been designed specifically for domestic use.
- The appliance can be used to prepare espresso and cappuccino coffee using ground coffee or coffee pods. Every other use is considered improper. Do not use the appliance for anything other than its intended use.
- The appliance is not designed to operate with external timers or with remote-control systems.
- This appliance may not be used by people (including children) of reduced physical, sensory or mental capacity, or without sufficient experience and knowledge, unless they are supervised or instructed by adults who are responsible for their safety.



1.4 General safety instructions

Follow all safety instructions in order to use the appliance safely.

- Read this user manual carefully before using the appliance.
- Switch off the appliance immediately after use.
- Do not leave the coffee machine unattended during use.
- Disconnect the appliance from the power socket as soon as you have finished using it and before cleaning it.
- Do not immerse the appliance, the power cord or the plug in water or any other liquid.
- Do not use the appliance when the power cord or the plug is damaged or when the appliance has been dropped or is damaged in any manner.
- If the power cord is damaged, contact technical support immediately to arrange replacement in order to avoid any possible hazards.
- Do not touch the appliance or its plug with wet hands.
- Prevent the power cord from coming into contact with sharp edges.
- Do not pull on the power cord to unplug the machine.
- Never position the appliance above or near gas or electric hob burners when they are hot or in use, inside an oven or near other heat sources.
- Do not position the appliance near sinks or taps.
- Do not try to repair the appliance yourself or without the assistance of a qualified technician.
- In the event of a fault, repairs should only be carried out by a qualified engineer.
- Do not make any modifications to the appliance.
- Never try to put out a fire or flames with water: turn off the appliance and remove the plug from the socket, and smother the flames with a fire blanket or other appropriate cover.
- Disconnect the appliance from the power socket before assembly, disassembly and cleaning, and as soon as you have finished using it.
- This appliance may be used by children from the age of 8 provided they are supervised or instructed on the safe use of the appliance and they understand the associated risks.
- Cleaning and maintenance may be performed by children from the age of 8 as long as they are appropriately supervised.
- Children must never play with the appliance. Keep the appliance out of children's reach.



Instructions

For this appliance

- Always disconnect the coffee machine from the power socket if it is left unattended and before assembly/disassembly of components or cleaning.
- Unplug the coffee machine before cleaning it and if you notice any fault.
- Let the coffee machine cool down before cleaning.
- Do not use the coffee machine without the tank fitted or if there is no water in the tank.
- Leave at least 3 cm of space between the coffee machine and any walls to the rear or side, and 15 cm clearance above the coffee machine.
- Danger of burns! The coffee machine generates heat and produces hot water and steam during its operation.
- Danger of burns! Do not touch the cup warmer shelf while the appliance is running.
- Do not use the coffee machine with parts or accessories of other manufacturers.
- Only use original spare parts. The use of spare parts not approved by the manufacturer could lead to fires, electric shocks or personal injury.
- Only place the coffee machine on level and dry surfaces.
- Avoid getting the coffee machine wet and do not spray liquids onto it. In the event of contact with liquid, immediately switch off the power at the socket or main breaker and dry the appliance thoroughly: Electric shock hazard!
- Do not use harsh detergents or sharp objects to clean the coffee machine.



1.5 Manufacturer liability

The manufacturer shall not be liable for injuries or property damage caused by:

- Use of the appliance other than that specified
- Failure to read the user manual
- Tampering with any part of the appliance
- Use of non-original spare parts
- Failure to observe the safety instructions

1.6 Identification plate

The identification plate bears the technical data, serial number and brand name of the appliance. Do not remove the identification plate for any reason.

1.7 Disposal



This appliance must be disposed of separately from other waste (Directive 2012/19/EU). The appliance does not contain substances in quantities sufficient to be considered hazardous to health and the environment, in accordance with current European directives.

- **Old appliances do not belong in household waste!** To comply with current legislation, old appliances, on reaching the end of their useful lives, should be taken to a disposal facility where they can be sorted. This allows precious materials from old appliances to be recycled and helps protect the environment. For further information, contact the relevant local authorities or your nearest waste recycling centre.

Our appliances are packed in non-polluting and recyclable materials.

- Take these packing materials to the appropriate recycling centre.



Plastic packaging Danger of suffocation

- Do not leave the packaging or any part of it unattended.
- Do not let children play with the plastic bags.



Electrical voltage Danger of electrocution

- Disconnect the mains supply.
- Unplug the appliance.



Description

2 Description

2.1 Product description

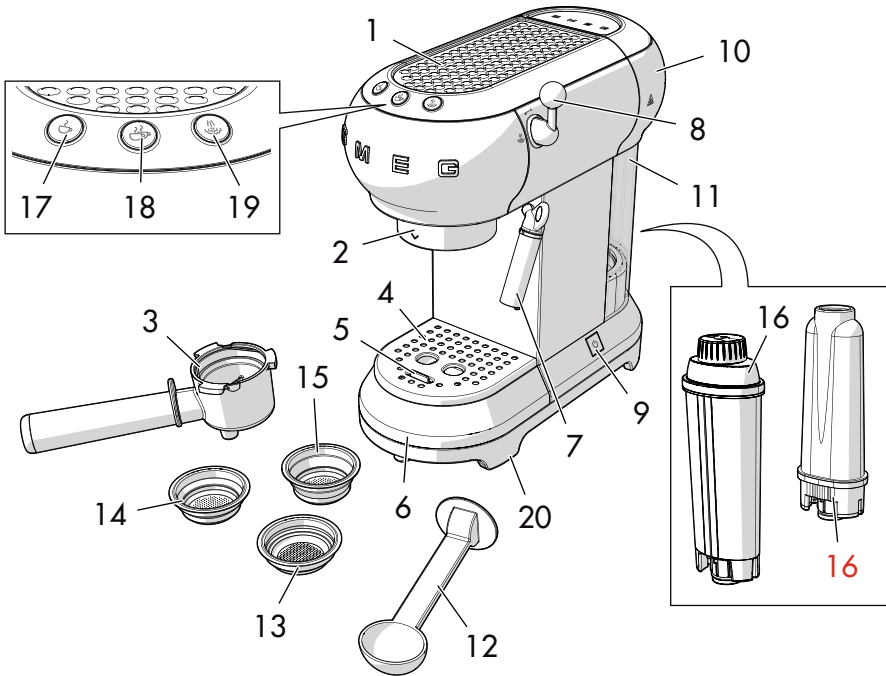

Model ECF01 - Coffee Machine

- | | |
|---|--|
| 1 Cup warmer shelf | 11 Water tank (1 litre) |
| 2 Boiler outlet | 12 Measuring/tamping scoop |
| 3 Filter holder | 13 Coffee pod filter |
| 4 Steel cup holder tray | 14 Ground coffee filter, 1 cup |
| 5 Float | 15 Ground coffee filter, 2 cups |
| 6 Stainless-steel drip tray | 16 Water softener filter (optional) |
| 7 Hot water/steam nozzle and frothing nozzle for cappuccino | 17 One-cup coffee button (white light) |
| 8 Steam knob | 18 Two-cup coffee button (white light) |
| 9 ON/OFF switch | 19 Steam button (white light)/Descal button (orange light) |
| 10 Water tank lid | 20 Non-slip feet |



3 Use



Danger of electrocution

- Plug into an earthed 3-pin socket.
- Do not remove the earth pin.
- Do not use an adapter.
- Do not use an extension cord.
- Failure to observe these warnings can lead to fire, electrocution or even death.

3.1 Before first use

1. Remove any labels and stickers from the coffee machine.
2. Carefully wash and dry the components of the coffee machine (see "4 Cleaning and care").
3. Remove the lid (1) by pulling it upwards, then remove the tank (2).

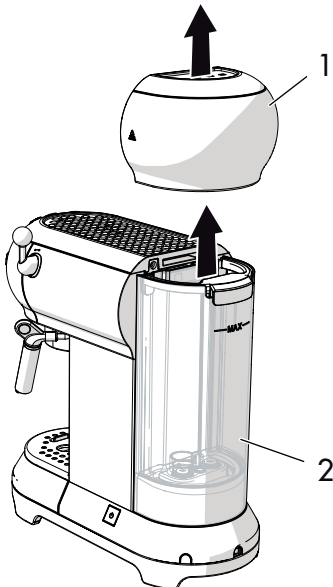

4. Fill the tank (2) with cool, clean water directly from the tap or using a jug, ensuring you do not exceed the maximum level on the tank.

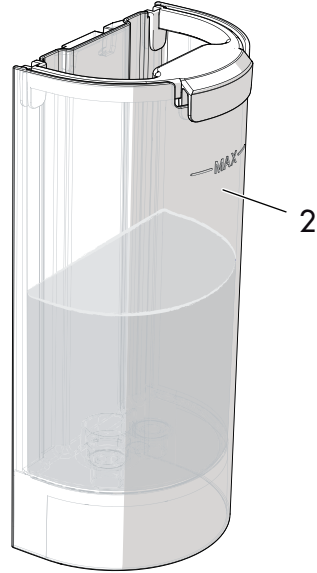

Danger of malfunction

- Do not use the coffee machine without the tank fitted or if there is no water in the tank.



The components intended to come into contact with food are made of materials that comply with the provisions of current legislation.





Use

3.2 First use

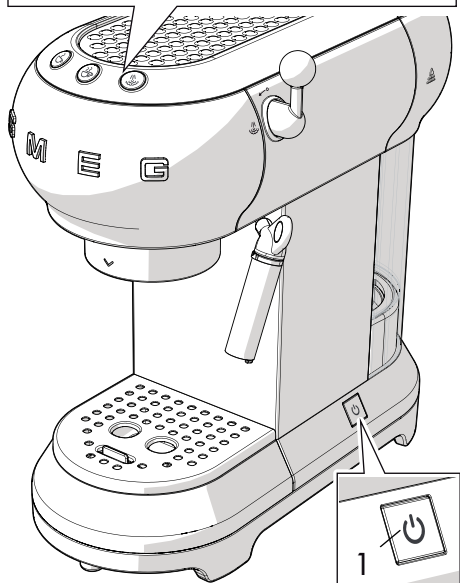
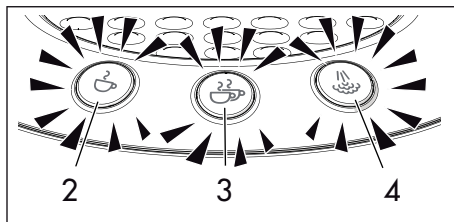
1. Switch on the coffee machine by pressing the ON/OFF switch (1): the lights of the three buttons (2), (3) and (4) will flash in sequence.



2. The lights (3) and (4) flash to indicate that the machine is warming up to the set temperature. The coffee machine is ready for use as soon as the lights stop flashing and are lit steadily.

3. Position a container under the hot water/steam nozzle (4).
4. Turn the steam knob (5) to the  position and dispense 100 ml of water.
5. Return the steam knob (5) to the  position.

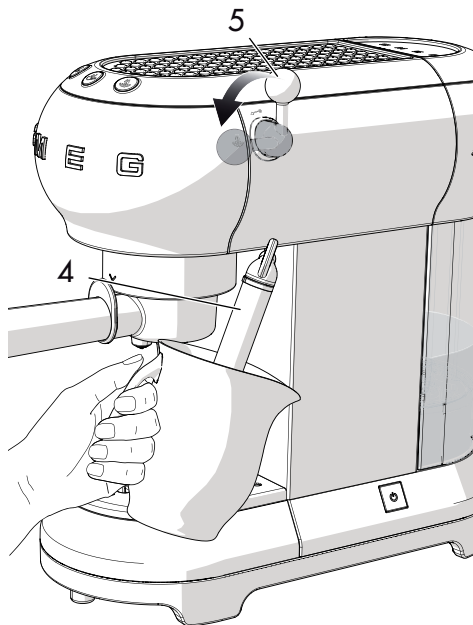



i Prepare 4-5 coffees or 4-5 cappuccinos to obtain best results.



3.3 How to prepare espresso coffee

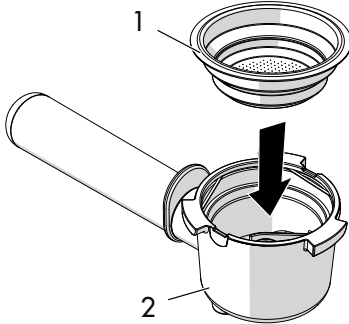

Ground coffee:

1. Insert the filter for ground coffee (1) in the filter holder (2), choosing between the one-cup filter  and two-cup filter .

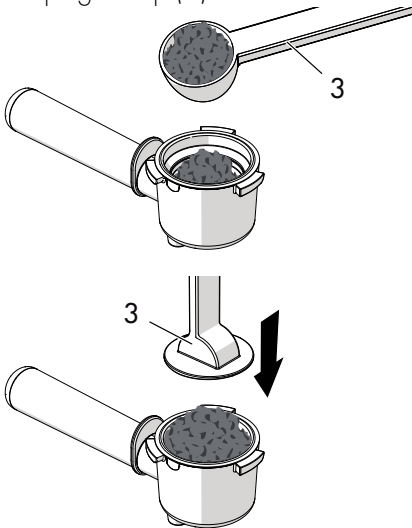

2. Tamp down the ground coffee using the tamping scoop (3).



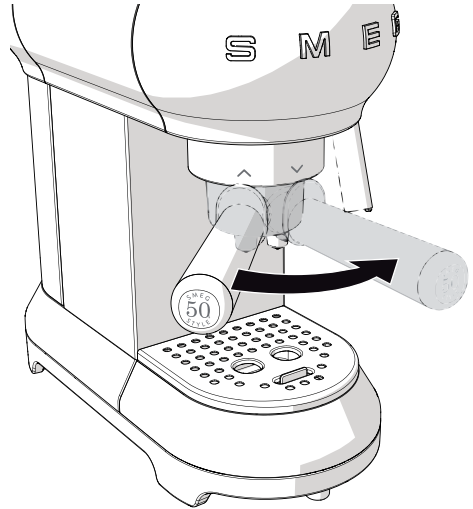

3. Remove any excess coffee from around the edge of the filter holder. Attach the filter holder by lining up the handle with  and turning it to the right up to the  position.



- For one cup, fill the filter with a level measure of coffee (approx. 7 grams).
- For two cups, fill the filter with two level measures.
- To obtain a strong coffee, tamp down the coffee firmly.
- To obtain a lighter coffee, tamp down the coffee less.



Use

4. Position the cup(s) under the filter holder spouts and press the  or  dispense button.

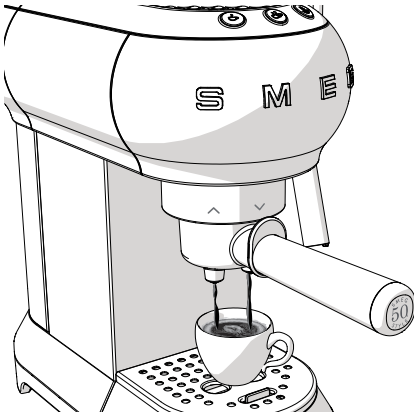

Danger of burns

- To avoid sprays, do not remove the filter holder while the machine is running: wait for a few seconds after dispensing has stopped.

Coffee pods:

1. Insert the coffee pod filter  in the filter holder.
2. Insert the coffee pod in the filter holder, centring it as much as possible.
3. Proceed in the same manner as for ground coffee.



Danger of burns

- To avoid sprays, do not remove the filter holder while the machine is running: wait for a few seconds after dispensing has stopped.





- You can stop the supply of coffee at any moment by pressing the dispense button again.
- To increase the quantity of coffee in the cup, hold down the dispense button.

3.4 How to prepare a cappuccino

1. Prepare an espresso coffee in a large cup.
2. Press the  button: the light will flash.
3. Fill a container with 100 ml of semi-skimmed milk for each cappuccino you wish to prepare.



4. When the  light stops flashing and is lit steadily, position an empty container underneath the frothing nozzle for cappuccino **(1)** and then open the steam knob **(2)** to the  position to discharge any water present, before closing the knob again.

5. Position the container with milk underneath the frothing nozzle for cappuccino **(1)** then immerse the frothing nozzle a few millimetres into the milk. Turn the knob **(2)** to the  position and slowly move the container upwards to obtain creamier foam.

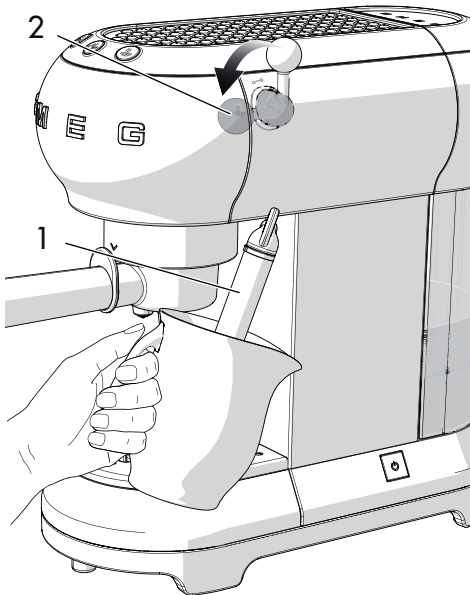

6. Once the volume of milk has doubled, immerse the frothing nozzle for cappuccino all the way and heat the milk up to 60°C. Stop the steam by turning the steam knob to the right.
7. Pour the milk into the cups with the espresso.



- To prepare more than one cappuccino, first prepare all the necessary cups of espresso, then steam the milk for all the cappuccinos together.
- For reasons of hygiene, it is advisable to clean the frothing nozzle for cappuccino after use.
- Discharge any milk residue by turning the steam nozzle to let the steam out.
- Do not dispense steam for longer than 60 seconds.



Use

3.5 How to heat water

1. Switch on the machine with the **ON/OFF** switch.
2. Position a container underneath the frothing nozzle for cappuccino.
3. Turn the steam knob to the  position to let out the hot water.













- Do not dispense steam for longer than 60 seconds.





3.6 Accessing the settings menu and changing the settings

1. Ensure that the machine is ready for use, then press and hold the  button for 10 seconds until the three buttons start flashing: the machine is now in settings mode.
2. Adjust the machine settings to your requirements.
3. To exit the menu, just wait 15 seconds without pressing any buttons.

Setting the coffee temperature



1. Access the settings menu.
2. Press the  button to select the coffee temperature. The lights for the current setting will turn on:

Lights	Temperature setting
  	Low
  	Medium
  	High

3. The lights will start flashing in sequence.
4. Press the button corresponding to the required temperature: low , medium  or high .
5. The  button flashes to indicate that the selection has been stored.

Setting the quantity of coffee

To modify the quantity of coffee dispensed by the machine:



1. Position one or two cups under the filter holder spouts.
2. Press the button for one cup  or two cups  and hold it down.
3. The machine will start dispensing coffee.







- Release the button as soon as the required quantity of coffee is reached.
- The light flashes to indicate that the selected quantity has been stored.

Setting the water hardness

- Access the settings menu.
- Press the  button to select the water hardness. The lights for the current setting will turn on:

Lights	Water setting
	Soft
	Medium
	Hard



- The lights will start flashing in sequence.
- Press the button corresponding to the water hardness: soft , medium  (18°F-36°F) or hard  (>36°F).
- The  button flashes to indicate that the selection has been stored.





Setting the automatic shut-off time

In order to save energy, the coffee machine will turn itself off when it has not been used for a certain period of time.

To set this time:

- Access the settings menu.
- Press  to select the auto shut-off time. The lights for the current setting will turn on:



Lights	Time setting
	9 minutes
	30 minutes
	3 hours

- The lights will start flashing in sequence.
- Press the button corresponding to the time you wish to set: 9 minutes , 30 minutes  or 3 hours .
- The  button flashes to indicate that the selection has been stored.



Restoring factory default values

To return the machine to its factory settings:

1. Access the settings menu.
2. Turn the steam knob to the  position.
3. Press the  button: the three lights will flash to indicate that the factory defaults have been reset.
4. Return the steam knob to the  position.

3.7 How to cool down the boiler

The boiler must be cooled down if you wish to prepare a coffee immediately after frothing milk.

If this procedure is not performed, the coffee dispensed will taste burnt.

1. Position a container underneath the frothing nozzle for cappuccino and open the steam knob to dispense hot water.

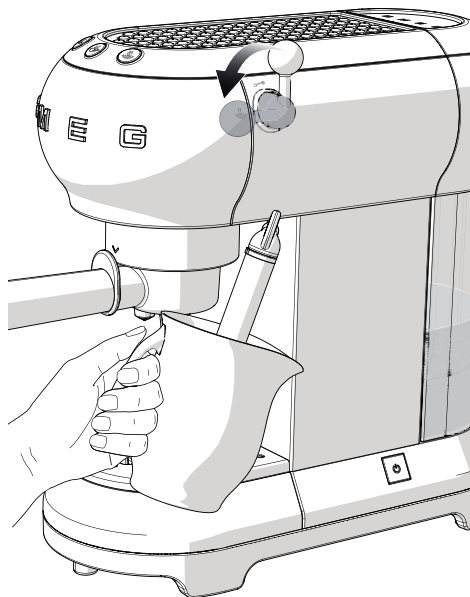

2. Hot water will stop coming out as soon as the boiler has cooled down.
3. Close the steam knob again and prepare the coffee.



4 Cleaning and care

4.1 Instructions



Improper use
Danger of electrocution

- Unplug the coffee machine before cleaning it.
- Do not immerse the coffee machine in water or other liquids.
- Let the coffee machine cool down before cleaning.



Improper use
Risk of damage to surfaces

- Do not use steam jets to clean the coffee machine.
- Do not use cleaning products containing chlorine, ammonia or bleach on parts with metal surface finishes (e.g. anodised, nickel- or chrome-plated).
- Do not use abrasive or corrosive detergents (e.g. powder products, stain removers and metallic scourers).
- Do not use rough or abrasive materials or sharp metal scrapers.

4.2 Cleaning the body of the coffee machine

To keep the outer surface of the coffee machine in good condition, it should be cleaned regularly after use. Let the appliance cool down first. Clean with a soft, damp cloth.

4.3 Cleaning the coffee machine components

Cleaning the drip tray

The drip tray is equipped with a red float (1) which sticks out of the cup holder tray when the maximum liquid level is exceeded.

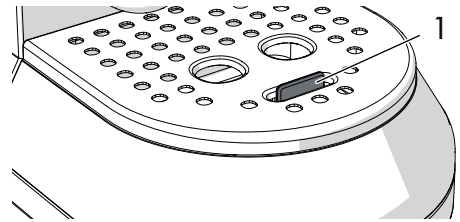

1. Remove the cup holder tray (2) and then remove the drip tray (3) to empty it.

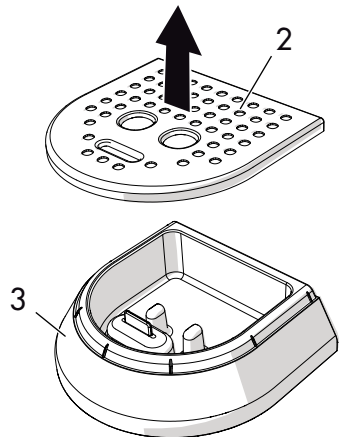

2. Clean the drip tray with a cloth and then reposition it together with the cup holder tray.

Cleaning the coffee filters

Clean the coffee filters regularly under running water. If the holes are blocked, clean them with a pin or a brush.



Cleaning and care

Cleaning the frothing nozzle for cappuccino

Clean the frothing nozzle for cappuccino immediately after use.

1. Turn the steam knob to let a little steam out and drive out any milk inside the nozzle.
2. Shut off the coffee machine by pressing the **ON/OFF** switch.
3. Hold the tube of the frothing nozzle (1) still with one hand and use the other to rotate the frothing nozzle (2) clockwise and pull it off downwards.

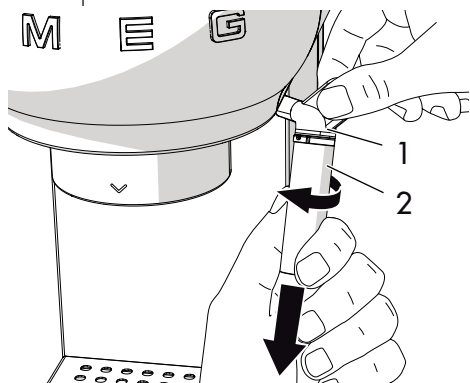

4. Remove the rubber connecting nozzle (3) from the frothing nozzle tube by pulling it downwards.

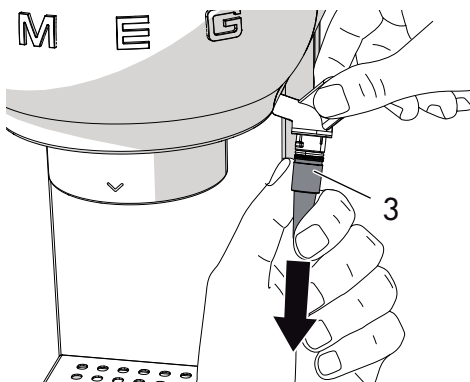

5. Wash the frothing nozzle and rubber connecting nozzle thoroughly with warm water.
6. Check that the hole (4) is not blocked.

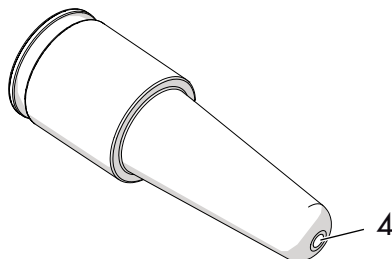

7. Insert the rubber connecting nozzle (3) back into the frothing nozzle tube (1) then replace the frothing nozzle (2) by pushing it upwards and rotating it anticlockwise.
8. Refit the frothing nozzle in its housing by following the cleaning instructions in reverse.

Cleaning the boiler outlet

The boiler outlet must be rinsed every 200 coffees made by dispensing approximately 500 ml of water by pressing the coffee dispense button without adding ground coffee or a pod.







Cleaning the water tank



Clean the water tank once a month using a moist cloth and mild detergent.



4.4 Descaling

The coffee machine needs descaling when the orange light on the  button lights up.

1. Fill the water tank with a solution of water and descaler, following the instructions on the package.
2. Press the **ON/OFF** switch.
3. Remove the filter holder and position a container underneath the frothing nozzle.
4. Wait for the  or  lights to come on steadily.
5. Press the  button and hold for 10 seconds until the three buttons flash in sequence.
6. Turn the steam knob to the  position.
7. Press  to start descaling.
8. The descaling cycle automatically performs a series of rinse cycles to remove scale from the coffee machine.
9. The descaling cycle will stop and the orange light  will flash.
10. Remove the water tank, empty it and rinse it out.

1. Fill the tank to the maximum level mark and insert it in its housing.
2. Position an empty container underneath the frothing nozzle and check that the steam knob is in the  position.
3. When the tank is empty it means that the rinse cycle is finished, and the orange light  will turn off.
14. Turn the steam knob to the  position.



Danger of injury

- The descaler contains acid which can irritate the skin and eyes.
- Follow the manufacturer's instructions and safety warnings on the pack to the letter; they will also tell you what to do in the event of contact with skin or eyes.
- Use descaler products recommended by Smeg to avoid damage to the coffee machine.

Descaling and rinsing the boiler outlet

During the descaling cycle, close the steam knob every so often to make some of the descaling solution come out from the boiler outlet.

During the rinse cycle, close the steam knob every so often to rinse off the boiler outlet.



Cleaning and care

4.5 What to do if...

Problem	Possible causes	Solution
	No water in tank.	Fill the tank.
	The filter holes are blocked.	Clean the filter with a brush or pin.
Coffee does not come out	The tank is not inserted correctly.	Insert the tank correctly in its housing.
	Scale build-up.	Perform a descaling cycle.
	The filter holder is not inserted correctly, or is dirty.	Insert the filter holder and turn it so it is fully closed. Clean the filter holder.
The coffee drips out of the filter holder and not the spouts	The boiler outlet seal is worn.	Have it replaced at an Authorised Service Centre.
	The spout holes are blocked.	Clean the spout holes.

Cleaning and care





EN

Problem	Possible causes	Solution
The filter holder will not attach to the coffee machine.	The filter has been overfilled.	Use the supplied measuring scoop and use the correct filter.
The coffee machine does not work and all lights flash.	Possible fault.	Unplug the coffee machine and contact an Authorised Service Centre.
	The ground coffee has not been tamped sufficiently.	Tamp the coffee harder.
The "crema" of the coffee is light in colour and comes out of the spout very fast	There is insufficient ground coffee.	Use a larger quantity.
	The coffee grind is too coarse.	Use only ground coffee for espresso machines.
	Poor quality ground coffee.	Change type of ground coffee.



Cleaning and care

Problem	Possible causes	Solution
	The ground coffee has been tamped too hard.	Tamp the coffee with less force.
	There is too much ground coffee.	Decrease the quantity used.
	The boiler outlet or filter is blocked.	Clean the outlet and the filter.
The "crema" of the coffee is dark in colour and comes out of the spout slowly	The coffee grind is too fine.	Use only ground coffee for espresso machines.
	Scale build-up.	Perform a descaling cycle.
The  and  lights flash for a few seconds	Steam knob open.	Close the steam knob.
	Boiler temperature too high.	Cool down the boiler.
	Scale build-up.	Perform a descaling cycle.

Cleaning and care



Problem

Possible causes

Solution

No water in tank.

Fill the tank.

Boiler outlet or filter blocked.

Clean the boiler outlet and the filter.

The tank is not inserted correctly.

Insert the tank correctly in its housing.



If the problem has not been resolved or in the case of other types of fault, contact your local technical support centre.

Il costruttore si riserva di apportare senza preavviso tutte le modifiche che riterrà utili al miglioramento dei propri prodotti. Le illustrazioni e le descrizioni contenute in questo manuale non sono quindi impegnative ed hanno solo valore indicativo.

The manufacturer reserves the right to make any changes deemed useful for improvement of its products without prior notice. The illustrations and descriptions contained in this manual are therefore not binding and are merely indicative.

Le fabricant se réserve la faculté d'apporter, sans préavis, toutes les modifications qu'il jugera utiles pour l'amélioration de ses produits. Les illustrations et les descriptions figurant dans ce manuel ne sont pas contraignantes et n'ont qu'une valeur indicative.

Der Hersteller behält sich vor, ohne vorherige Benachrichtigung alle Änderungen vorzunehmen, die er zur Verbesserung seiner Produkte für nützlich erachtet. Die in diesem Handbuch enthaltenen Illustrationen und Beschreibungen sind daher unverbindlich und dienen nur zur Veranschaulichung.

De fabrikant behoudt zich het recht voor zonder waarschuwing alle wijzigingen aan te brengen die hij nodig acht om zijn producten te verbeteren. De afbeeldingen en de beschrijvingen die aanwezig zijn in deze handleiding zijn niet bindend, en hebben enkel een aanduidende waarde.

El fabricante se reserva el derecho a aportar sin aviso previo todas las modificaciones que considere útiles para la mejora de sus propios productos. Las ilustraciones y las descripciones contenidas en este manual no comprometen, por tanto, al fabricante y tienen un valor meramente indicativo.

O fabricante reserva-se o direito de efetuar, sem aviso prévio, qualquer modificação que vise o melhoramento dos respectivos produtos. As ilustrações e descrições contidas neste manual, não são, por isso, vinculativas e possuem apenas valor indicativo.

Tillverkaren förbehåller sig rätten att genomföra alla de ändringar som anses nödvändiga för att förbättra de egna produkterna utan att meddela detta i förväg. De illustrationer och beskrivningar som finns i denna bruksanvisning är vägledande och därmed inte bindande.

Производитель оставляет за собой право вносить без предупреждения все изменения, которые посчитает полезными для улучшения собственной продукции. Рисунки и описания, содержащиеся в данном Руководстве по эксплуатации, не имеют обязательств и имеют ознакомительный характер.

Producenten forbeholder sig retten til at foretage eventuelle ændringer, der anses for at være en forbedring af det oprindelige produkt, uden forudgående varsel. Illustrationer og beskrivelser i denne betjeningsvejledning er derfor ikke bindende og kun vejledende.

Producent zastrzega sobie prawo do nanoszenia, bez uprzedniego powiadomienia, wszelkich zmian, które uzna za przydatne w celu ulepszenia swoich produktów. Rysunki i opisy zawarte w niniejszej instrukcji nie są zobowiązujące i mają charakter poglądowy.

Valmistaja pidättää itsellään oikeuden tehdä ohjeisiin mielestään tarpeellisia muutoksia ilman ennakkoilmoitusta. Tässä oppaassa olevat kuvat ja piirroset eivät näin ollen ole sitovia, vaan ne annetaan vain viitteellisessä mielessä.

Produsenten forbeholder seg rett til endringer på sine produkter grunnet tekniske fremskritt, uten forutgående varsel. Illustrasjonene og beskrivelsene i denne bruksanvisningen er derfor ikke bindende og skal kun betraktes som retningsgivende.



914777365/A