

Klipsch®

KEEPERS OF THE SOUND™



KLIPSCH STATUS
OWNER'S MANUAL



Welcome to Klipsch. Listen with Passion.

Congratulations on your purchase and thank you for selecting Klipsch STATUS headphones. These headphones have been crafted with the finest materials - high-grade leather, professional grade memory foam, HiFi inspired woven cables and high-strength polymers - to create a product unmatched in the industry for superior quality and comfort, with the audio performance you would expect from Klipsch.

As a Klipsch headphone owner, you belong to an elite circle of highly discerning listeners that's 65+ years in the making. Every product we make - from headphones to home theater - reflects our no-compromise attitude and commitment to delivering the industry's most powerful, detailed and emotional sound experience.

Your Klipsch STATUS headphones have been designed and manufactured to the highest quality standards. Each pair undergoes rigorous testing before leaving the factory and comes with a limited two-year warranty. This attention to detail guarantees years of reliable performance. We hope these headphones bring new life to your music and years of comfortable listening.

Register your product today at [klipsch.com/register](https://www.klipsch.com/register)

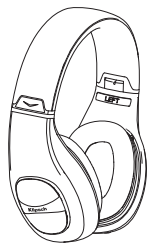

Klipsch STATUS headphones

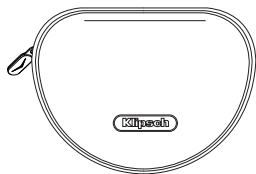

Carrying case

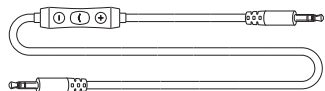

Apple 3-button controller cable

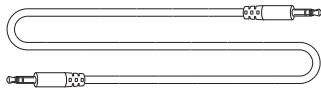

Standard headphone cable



1/4" Stereo adapter

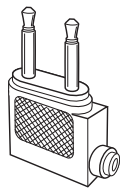

Airline adapter

CABLES

Klipsch STATUS headphones are compatible with all audio sources with a 3.5mm headphone jack using the included standard headphone cable.

The included Apple 3-button controller cable provides enhanced functionality with compatible Apple devices.



Visit Klipsch.com for latest compatibility info.

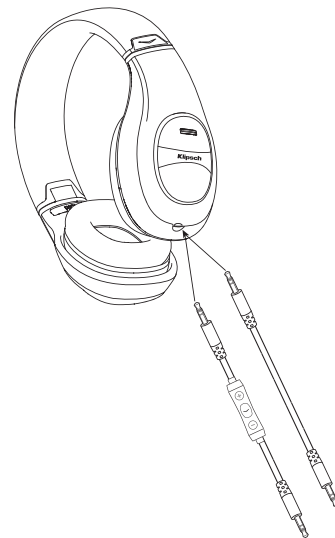

1/4" STEREO ADAPTER

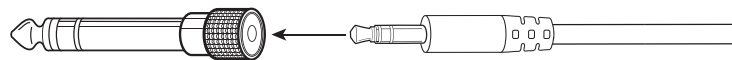

RE-ATTACHING EARCUPS

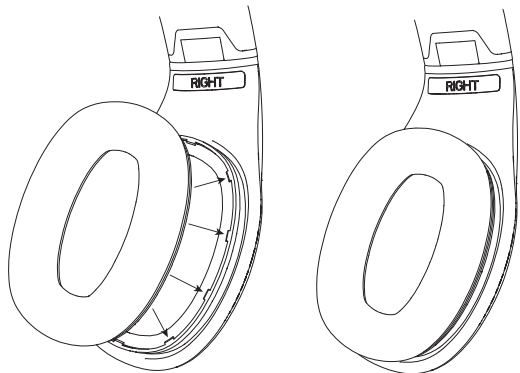

STORING THE HEADPHONES

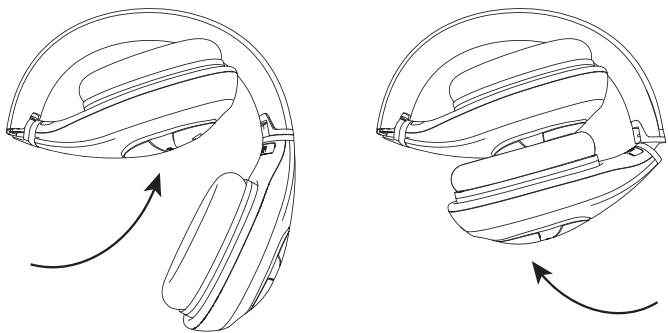

USING WITH IN-FLIGHT ENTERTAINMENT SYSTEMS

Audio jack configurations on airplanes vary. Note jack configurations in the chart below:



A single, 3.5 mm jack

No adapter needed.



One 3.5 mm jack and one power jack

Use the single plug in the 3.5 mm jack.
The power jack does not need a connection.



Two 3.5 mm jacks

Use the included airline adapter



One power jack and two 3.5 mm jacks

Use the included airline adapter for the two 3.5 mm jacks.
The power jack does not need a connection.

Bienvenue à Klipsch. Écouter avec passion.

Toutes nos félicitations pour votre achat et merci d'avoir choisi les écouteurs STATUS de Klipsch. Ces écouteurs supprimeurs de bruit ont été fabriqués avec les matériaux les plus fins : cuir de haute qualité, mousse-mémoire de qualité professionnelle, câbles tissés d'inspiration HiFi et polymères de haute résistance, afin de créer un produit à la qualité et au confort inégalés avec les performances audio que vous attendez de Klipsch.

En tant que propriétaire d'écouteurs Klipsch, vous appartenez à l'élite des auditeurs d'une extrême exigence que nous servons depuis plus de 65 ans. Chaque produit que nous fabriquons, des écouteurs aux cinéma-maison, reflète notre principe et notre engagement absolu à apporter à nos clients le son le plus puissant, le plus détaillé et le plus émotionnel.

Vos écouteurs STATUS de Klipsch ont été conçus et fabriqués selon les normes de qualité les plus élevées. Chaque paire d'écouteurs fait l'objet de tests rigoureux avant de quitter l'usine et bénéficie d'une garantie limitée de deux ans. Cette attention aux détails assure des années d'utilisation fiable. Nous espérons que ces écouteurs donneront une nouvelle vie à votre musique et que vous bénéficierez d'une écoute confortable pendant des années.

Enregistrez votre produit dès aujourd'hui à [klipsch.com/register](https://www.klipsch.com/register)

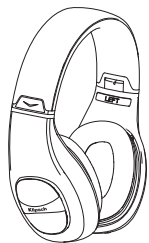

Écouteurs STATUS de Klipsch

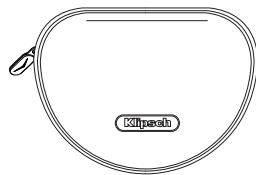

Carrying case

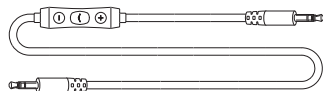

Câble à contrôleur à 3 boutons d'Apple

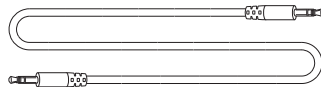

Câble d'écouteurs standard

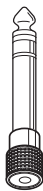

Adaptateur stéréo 1/4 po (0,6 mm)

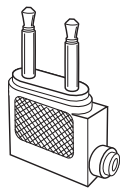

Adaptateur d'avion

CÂBLES

Les écouteurs STATUS de Klipsch sont compatibles avec toutes les sources audio à l'aide d'une prise casque de 3,5 mm, en utilisant le câble d'écouteurs standard inclus.

Le câble à contrôleur à 3 boutons d'Apple inclus fournit une fonctionnalité améliorée avec les appareils Apple compatibles.

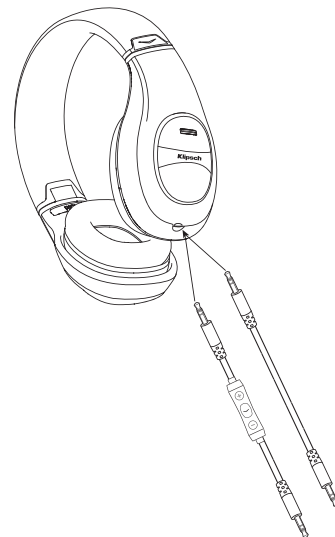

Made for

 iPod  iPhone  iPad

Consultez le site Klipsch.com pour les dernières informations de compatibilité.

ADAPTATEUR STÉRÉO 1/4 PO (0,6 MM)

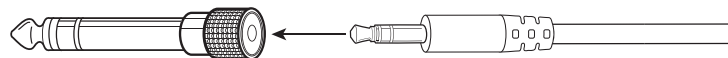

REMISE EN PLACE DES OREILLETTES

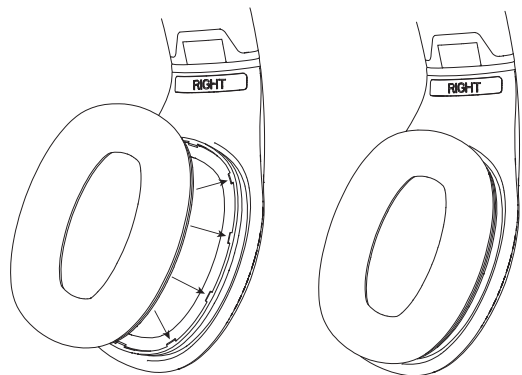

RANGEMENT DES ÉCOUTEURS

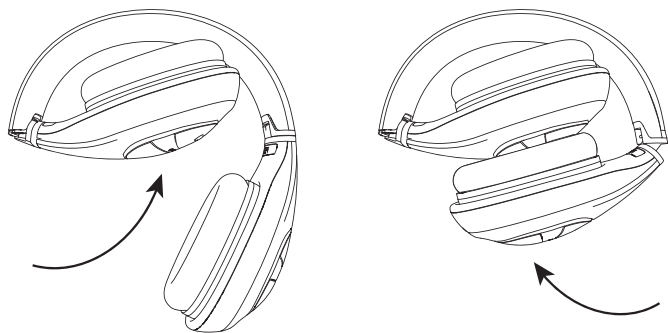

UTILISATION AVEC DES SYSTÈMES DE DIVERTISSEMENT EN AVION

La configuration de la prise d'écoute dans les avions varie. Le diagramme ci-dessous donne les configurations de prise d'écoute :



Une seule prise d'écoute de 3,5 mm

Aucun adaptateur nécessaire.



Une prise d'écoute de 3,5 mm et une prise d'alimentation

Utiliser la fiche unique dans la prise d'écoute de 3,5 mm.
La prise d'alimentation ne nécessite aucun branchement.



Deux prises d'écoute de 3,5 mm

Utiliser l'adaptateur d'avion inclus



Une prise d'alimentation et deux prises d'écoute de 3,5 mm

Utiliser l'adaptateur d'avion inclus pour les deux prises d'écoute de 3,5 mm.
La prise d'alimentation ne nécessite aucun branchement.

Bienvenido a Klipsch. Escuche con pasión.

Felicitaciones por su compra y gracias por seleccionar los auriculares STATUS de Klipsch. Estos auriculares de cancelación activa de ruido han sido construidos con los más finos materiales -cuero de alta calidad, espuma de memoria de calidad profesional, cables tejidos inspirados en la alta fidelidad y polímeros de alta resistencia- para crear un producto sin igual en la industria en cuanto a calidad y comodidad, y con la fidelidad de sonido que usted espera de Klipsch.

Como nuevo propietario de estos auriculares Klipsch, usted pertenece a una élite de oyentes altamente exigentes que tiene 65 años de historia. Todos los productos que hacemos, desde los auriculares hasta el cine en casa, reflejan nuestro espíritu y dedicación inflexibles dirigidos a la producción de la más poderosa, detallada y emotiva experiencia de sonido.

Sus auriculares STATUS de Klipsch han sido diseñados y fabricados de acuerdo con los más altos estándares de calidad. Cada par pasa por rigurosas pruebas de resistencia antes de salir de la fábrica y tiene una garantía limitada de dos años. Esta atención a los detalles garantiza muchos años de rendimiento confiable. Esperamos que estos auriculares le den nueva vida a su música y muchos años de cómoda audición.

Registre su producto hoy mismo en www.klipsch.com/register

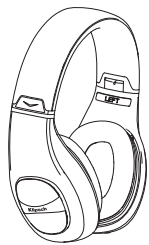

Auriculares STATUS de Klipsch

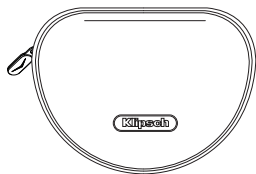

Estuche de viaje

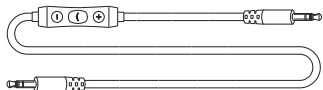

Cable de control Apple de 3 botones

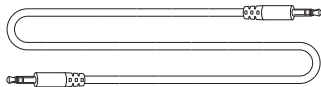

Cable de auriculares estándar



Adaptador estereofónico de 1/4 plg.

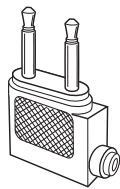

Adaptador para aviones

CABLES

Los auriculares STATUS de Klipsch son compatibles con todas las fuentes de audio con conector de auriculares de 3.5 mm por medio del cable de auriculares estándar que se incluye.

El cable de control de 3 botones de Apple que se incluye da una funcionalidad mejorada con dispositivos compatibles de Apple.



En Klipsch.com se encuentra la información más reciente sobre compatibilidad.

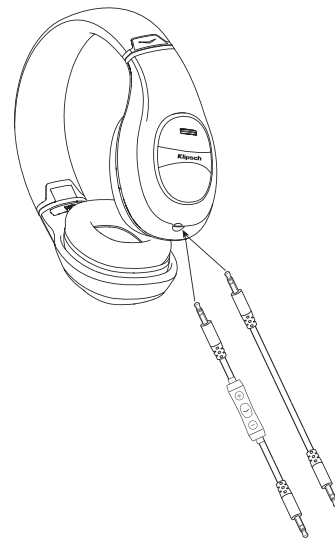

ADAPTADOR ESTEREOFÓNICO DE 1/4 PLG.

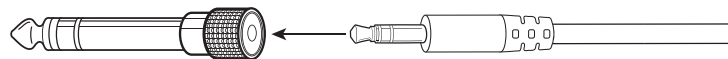

FIJACIÓN DE LAS COPAS DE LOS AURICULARES

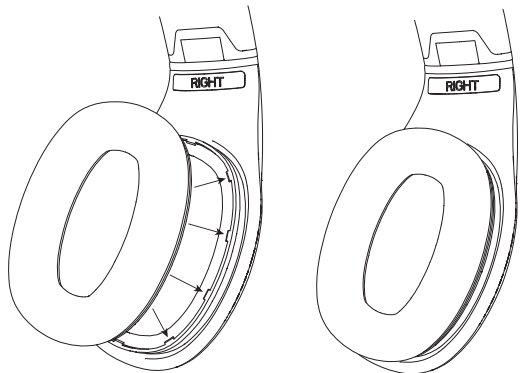

ALMACENAMIENTO DE LOS AURICULARES

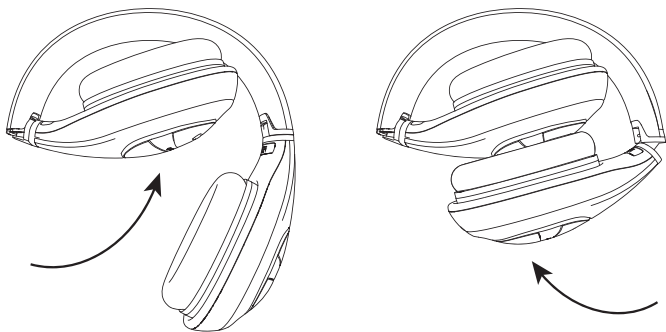

USO CON SISTEMAS DE ENTRETENIMIENTO EN VUELO

Las configuraciones de los conectores de audio de avión varían. Observe las configuraciones de conector que se presentan en la siguiente tabla:



Un solo conector de 3.5 mm

No se necesita adaptador.



Un conector de 3.5 mm y un conector de alimentación

Ponga el enchufe único en el conector de 3.5 mm.
El conector de alimentación no necesita conexión.



Dos conectores de 3.5 mm

Enchufe el adaptador de conector de avión que se incluye



Un conector de alimentación y dos conectores de 3.5 mm

Enchufe el adaptador de conector de avión que se incluye en los dos conectores de 3.5 mm. El conector de alimentación no necesita conexión.

Willkommen bei Klipsch. Begeisternder Sound.

Herzlichen Glückwunsch für den Kauf eines Klipsch STATUS-Kopfhörers. Dieser Kopfhörer mit aktiver Geräuschunterdrückung wurde unter Verwendung bester Werkstoffe hergestellt - hochwertiges Leder, Schaumstoff mit Formgedächtnis in professioneller Qualität, HiFi-Gewebebandkabel und belastungsfähige Polymere - um ein Produkt zu erzeugen, das branchenweit bezüglich Qualität und Komfort seinesgleichen sucht und dazu noch die Audioleistung bietet, die Sie von Klipsch erwarten.

Als Besitzer eines Klipsch-Kopfhörers gehören Sie zu einem exklusiven Kreis von Zuhörern mit hohen Ansprüchen an die Audioqualität, der seit 65 Jahren existiert. Jedes von uns hergestellte Produkt, von Kopfhörern bis zu Heimkinosystemen, zeigt unsere kompromisslose Einstellung und unsere Verpflichtung, das leistungsstärkste, detaillierteste und emotionalste Sounderlebnis dieser Branche zu bieten.

Ihr Klipsch STATUS-Kopfhörer wurde nach den höchsten Qualitätsstandards entwickelt und hergestellt. Jeder Kopfhörer wird vor Auslieferung rigoros getestet und hat eine eingeschränkte Zweijahresgarantie. Diese Liebe zum Detail garantiert, dass der Kopfhörer jahrelang zuverlässig funktioniert. Wir hoffen, dass dieser Kopfhörer Ihnen ein ganz neues Musikerlebnis und jahrelangen Tragekomfort bietet.

Registrieren Sie Ihr Produkt noch heute bei [klipsch.com/register](https://www.klipsch.com/register)

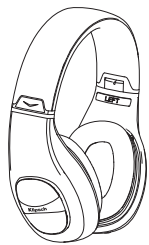

Klipsch STATUS-Kopfhörer

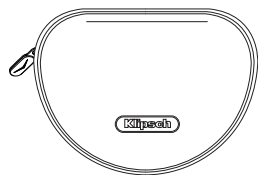

Reiseetui

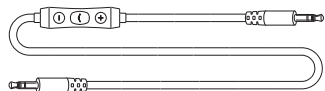

Apple 3-Tasten-Reglerkabel

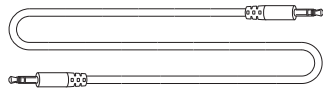

Standard-Kopfhörerkabel

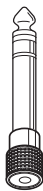

1/4-Zoll-Stereoadapter

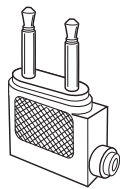

Flugzeug-Adapter

KABEL

Der Klipsch STATUS-Kopfhörer ist dank seines mitgelieferten Standard-Kopfhörerkabels mit allen Audioquellen kompatibel, die eine 3,5-mm-Kopfhörerbuchse besitzen.

Das im Lieferumfang enthaltene Apple 3-Tasten-Reglerkabel bietet bei kompatiblen Apple-Geräten einen zusätzlichen Funktionsumfang.



Die aktuellsten Informationen zur Kompatibilität finden Sie auf klipsch.com.

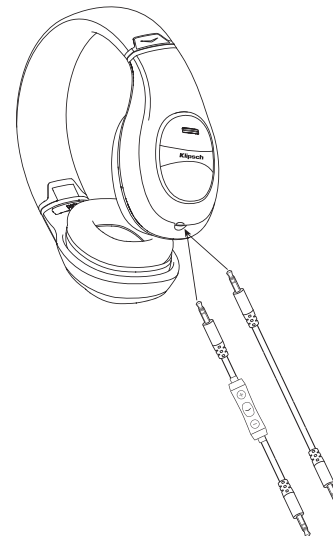

1/4-ZOLL-STEREOADAPTER

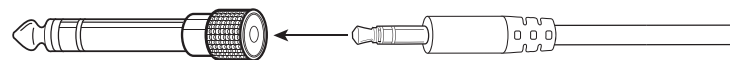

WIEDERANBRINGEN DER OHRPOLSTER

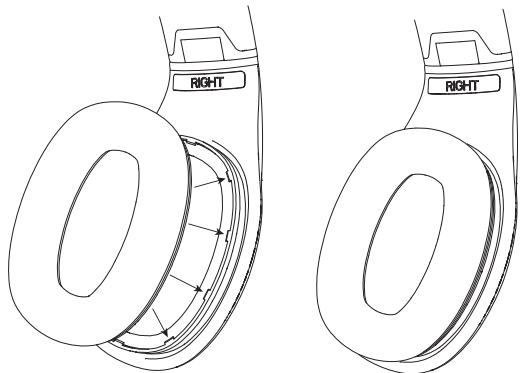

AUFBEWAHRUNG DES KOPFHÖRERS

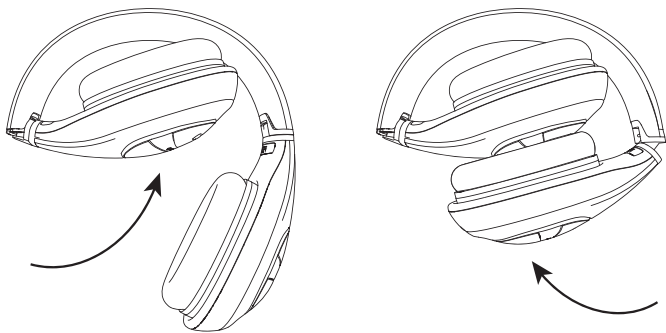

ANSCHLUSS AN FLUGZEUG-UNTERHALTUNGSSYSTEME

In Flugzeugen gibt es unterschiedliche Audio-Buchsenkonfigurationen. Untenstehende Tabelle zeigt die Buchsenkonfigurationen:



Eine 3,5-mm-Buchse

Kein Adapter erforderlich.



Eine 3,5-mm-Buchse und eine Ladebuchse

Stecken Sie den Einzelstecker in die 3,5-mm-Buchse.
Es muss nichts an die Ladebuchse angeschlossen w



Zwei 3,5-mm-Buchsen

Verwenden Sie beiliegenden Flugzeugadapter



Eine Ladebuchse und zwei 3,5-mm-Buchsen

Verwenden Sie beiliegenden Flugzeugadapter für die beiden 3,5-mm-Buchsen.
Es muss nichts an die Ladebuchse angeschlossen werden.

Grazie per aver acquistato un prodotto Klipsch. La passione dell'ascolto.

Congratulazioni per il tuo acquisto e grazie per aver scelto le cuffie Klipsch STATUS. Le nostre cuffie sono costruite con i migliori materiali (pelle di altissima qualità schiuma viscoelastica professionale, cavi intrecciati ispirati ai sistemi HiFi e polimeri ad alta resistenza) per creare un prodotto impareggiabile nel settore, una qualità e un comfort superiori e le prestazioni audio che ti aspetteresti da Klipsch.

I proprietari di cuffie Klipsch appartengono a un'élite esclusiva di ascoltatori estremamente raffinati, che apprezzano la nostra esperienza di oltre 65 anni nella produzione di articoli per l'ascolto ai massimi livelli. Ogni prodotto che esce dalla nostra azienda, dalle cuffie agli impianti Home Theater, è il risultato del nostro rigore senza compromessi e del nostro impegno a offrire il suono più potente, preciso ed emozionante del settore.

Le cuffie Klipsch STATUS sono progettate e prodotte secondo i più elevati standard di qualità. Ogni coppia di cuffie deve superare rigorosi test prima di lasciare l'azienda ed è coperta da una garanzia limitata di due anni. Questa attenzione per il dettaglio ne garantisce il funzionamento efficiente per anni. Ci auguriamo che queste cuffie porteranno nuova vita al tuo ascolto e ti accompagneranno per anni.

Prodotto può essere registrato on-line sul sito [klipsch.com/register](https://www.klipsch.com/register)

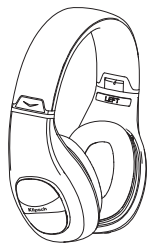

Cuffie Klipsch STATUS

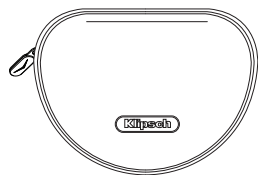

Custodia di trasporto

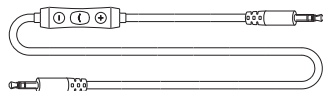

Cavo con comando a 3 pulsanti Apple

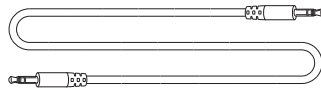

Cavo standard per cuffie

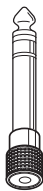

Adattatore stereo da 1/4"

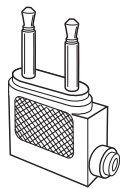

Adattatore per aereo

CAVI

Le cuffie Klipsch STATUS sono compatibili con tutti gli apparecchi audio dotati di jack per cuffia da 3,5 mm mediante il cavo standard fornito.

Il cavo con comando a 3 pulsanti Apple offre ulteriori funzionalità con i dispositivi Apple compatibili.



Visitare klipsch.com per le informazioni più recenti sulla compatibilità

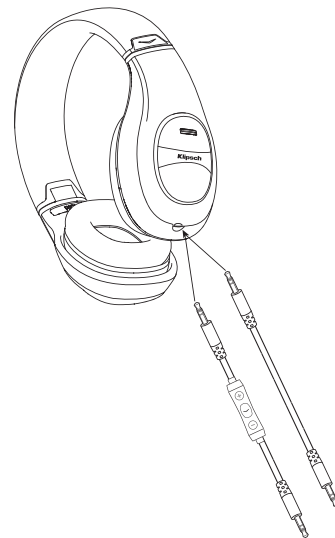

ADATTATORE STEREO DA 1/4"

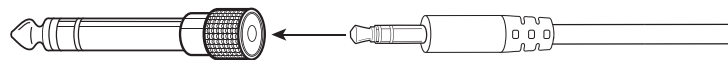

FISSAGGIO DEI PADIGLIONI

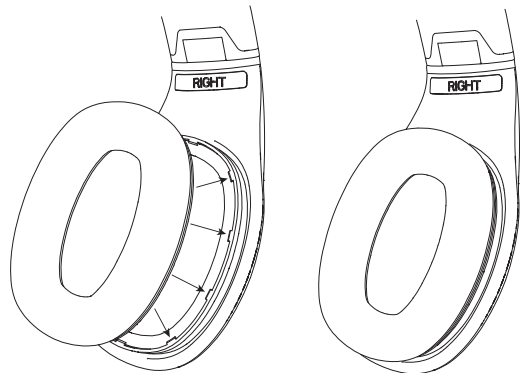

RIPIEGAMENTO DELLE CUFFIE

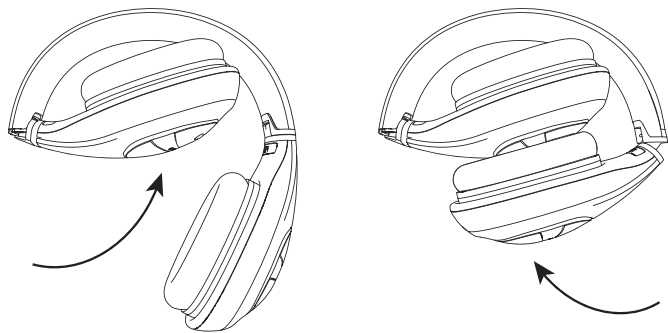

USO CON I SISTEMI DI INTRATTENIMENTO IN VOLO

I jack audio sugli aerei possono avere configurazioni diverse, come esemplificato qui di seguito:



Un jack da 3,5 mm

Adattatore non necessario.



Un jack da 3,5 mm e un jack di alimentazione

Usare il connettore singolo nel jack da 3,5 mm.
Il jack di alimentazione non deve essere collegato.



Due jack da 3,5 mm

Usare l'adattatore per aereo fornito.



Un jack di alimentazione e due jack da 3,5 mm

Usare l'adattatore per aereo fornito per i due jack da 3,5 mm.
Il jack di alimentazione non deve essere collegato.

Bem-vindo à Klipsch. Ouça com paixão.

Parabéns pela sua compra e obrigado por escolher o fone de ouvido Klipsch STATUS. Este fone de ouvido foi fabricado com materiais sofisticados - couro de alta qualidade, espuma viscoelástica de grau profissional, cabos revestidos com tecido e polímeros de alta resistência inspirados em HiFi - para criar um produto incomparável no setor e oferecer qualidade e conforto superiores, com o desempenho de áudio que se espera da Klipsch.

Como proprietário de um fone de ouvido da Klipsch, você faz parte de um grupo seleto de ouvintes altamente exigentes que está em formação há 65 anos. Todos os produtos que fabricamos, desde fones de ouvido a produtos de cinema em casa, refletem a nossa atitude de não abrir mão da qualidade e nosso compromisso de proporcionar a experiência sonora mais potente, detalhada e emocionante do setor.

Os fones de ouvido Klipsch STATUS foram projetados e fabricados de acordo com os mais elevados padrões de qualidade. Cada par passa por um teste rigoroso antes de deixar a fábrica e é acompanhado por uma garantia de dois anos. Esta atenção aos detalhes garante anos de desempenho confiável. Esperamos que este fone de ouvido revigore suas músicas e proporcione anos de audição confortável.

Registre seu produto hoje mesmo no site
www.klipsch.com/register.

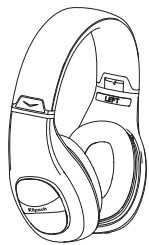

Fone de ouvido Klipsch STATUS

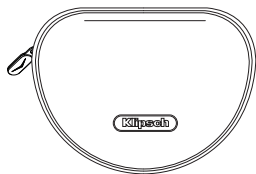

Estojo de transporte

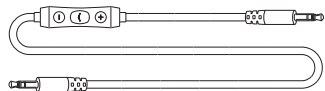

Cabo de controle Apple com 3 botões

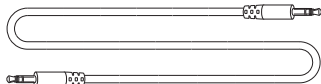

Cabo para fones de ouvido padrão



Adaptador estéreo de 1/4"

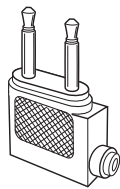

Adaptador para uso em aeronaves

CABOS

Os fones de ouvido Klipsch STATUS são compatíveis com todas as fontes de áudio com o cabo para fones de ouvido padrão com pino de 3,5 mm incluído.

O cabo de controle Apple com 3 botões incluído fornece funcionalidade avançada com dispositivos Apple compatíveis.



Acesse Klipsch.com para obter as mais recentes informações de compatibilidade.

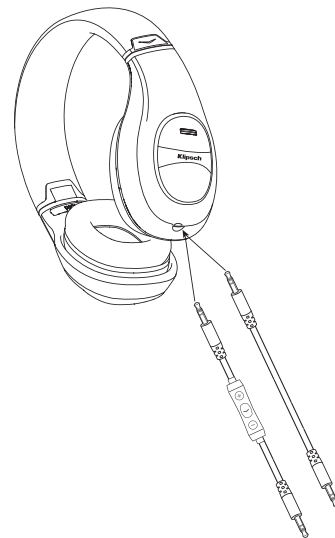

ADAPTADOR ESTÉREO DE 1/4"

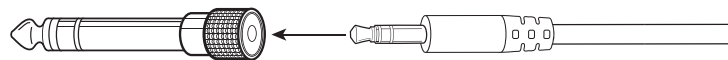

COMO ENCAIXAR OS AURICULARES

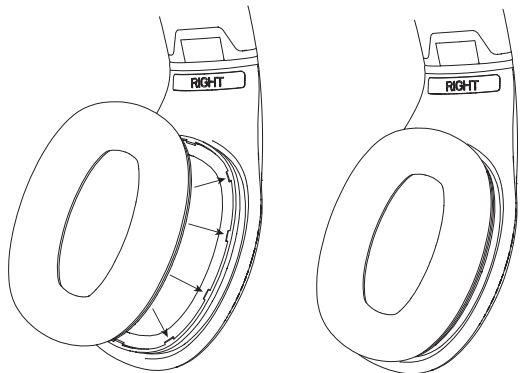

COMO GUARDAR O FONE DE OUVIDO

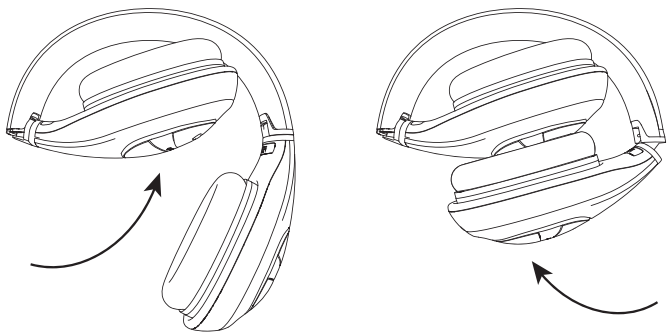

COMO USAR A UNIDADE COM SISTEMAS DE ENTRETENIMENTO EM AVIÕES

As configurações das tomadas de áudio variam nos aviões. Veja as configurações das tomadas na tabela abaixo:



Uma única tomada de 3,5 mm.

Nenhum adaptador é necessário.



Uma tomada de 3,5 mm e uma tomada de energia.

Use o plugue simples na tomada de 3,5 mm.
A tomada de energia não requer conexão.



Duas tomadas de 3,5 mm.

Use o adaptador para aeronaves incluído.



Uma tomada de energia e duas tomadas de 3,5 mm.

Use o adaptador para aeronaves incluído para as duas tomadas de 3,5 mm.
A tomada de energia não requer conexão.

欢迎使用 **Klipsch**。听觉的享受。

祝贺您购买了本产品，感谢您选择 **Klipsch STATUS** 耳机。这些有源降噪耳机均使用最好的材料精心制成，使用高级皮革、专业级记忆海绵、高保真编织线缆和高强度聚合物的目的，都是为了创造一种业内无与伦比的优越质量与舒适度，让您从 **Klipsch** 获得期待的音响效果。

作为 **Klipsch** 耳机的用户，您将成为 65 年来形成的极有鉴赏力的精英听众圈的一员。我们生产的每一款产品——从耳机到家庭影院——都反映了我们对于提供业内最强大、最精致和最具感染力的音效体验的绝不妥协的态度和承诺。

您的 **Klipsch STATUS** 耳机是按照最高的质量标准设计和生产的。每一副耳机在出厂前均经过严格的测试，并且享有两年有限保修期。这一对细节的注重保证了长久的可靠性能。我们希望这些耳机能为您的音乐生活带来新的体验和长久舒适的听觉享受。

请今天就在 [klipsch.com/register](https://www.klipsch.com/register) 注册您的产品

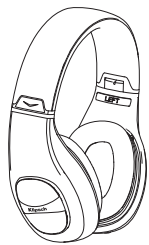

Klipsch STATUS 耳机

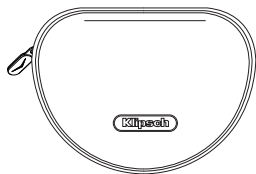

旅行夹

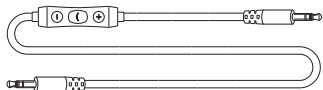

Apple 3 键控制器线缆

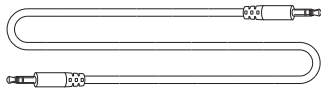

标准耳机线缆



1/4" 立体声适配器

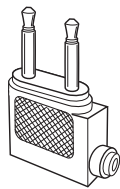

航空适配器

线缆

使用随附的标准耳机线缆，Klipsch STATUS 适用于所有带有 3.5mm 耳机插口的音频源

随附的 Apple 3 键控制器线缆为兼容的 Apple 设备提供增强的功能。



有关最新的兼容信息，请访问 Klipsch.com

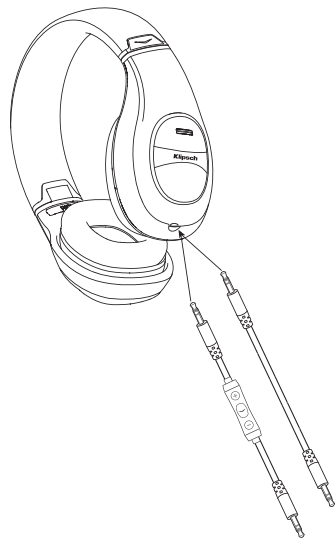

1/4" 立体声适配器



重新装好耳机杯

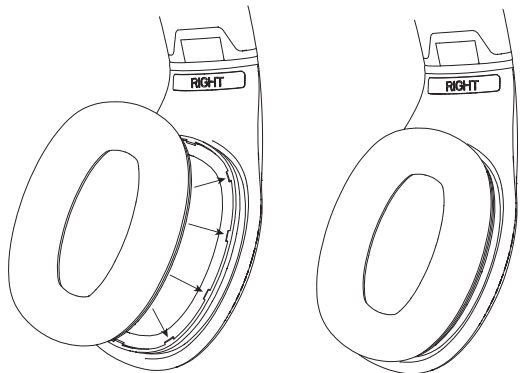

存放耳机

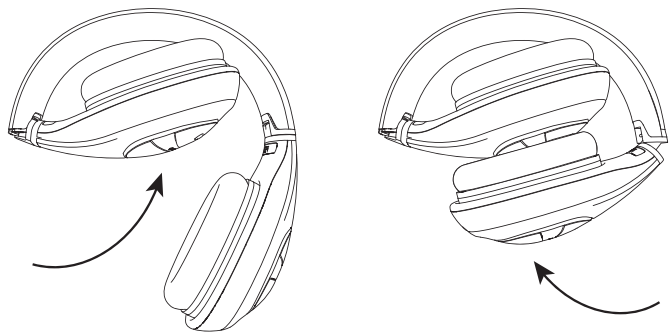

与飞机上娱乐系统一起使用

音频插口配置因飞机而异。 请注意下列图表中的插口配置：



单个 3.5mm 插口

无需适配器。



一个 3.5mm 插口和一个电源插口

使用 3.5mm 插口中的单个插座。
电源插口不需要连接。



两个 3.5mm 插口

使用随附的航空适配器



一个电源插口和两个 3.5mm 插口

在两个 3.5mm 插口处使用随附的航空适配器。
电源插口不需要连接。

Klipsch®

KEEPERS OF THE SOUND™

KLIPSCH.COM

3502 Woodview Trace • Indianapolis, IN 46268 • 1-800-KLIPSCH
Designed and engineered in Indianapolis, IN by Klipsch, USA.

©2012, Klipsch Group, Inc. is a wholly-owned subsidiary of Vox International Corporation.
Klipsch is a trademark of Klipsch Group Inc., registered in the U.S. and other countries.
Product of China.

iPad, iPhone, iPod are trademarks of Apple Inc., registered in the U.S. and other countries.