

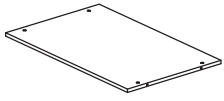









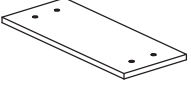
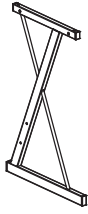
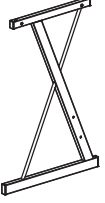
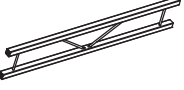
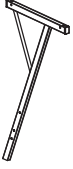
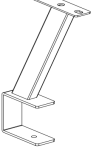



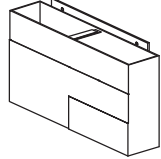

# For The Win Gaming Desk | L-Shape - 131 cm

## Manual



<b>A</b>  x2	<b>B</b>  x1	<b>C</b>  x1	<b>D</b>  x1	<b>E</b>  x1						
<b>F</b>  x2	<b>G</b>  x2	<b>H</b>  x2	<b>I</b>  x1	<b>J</b>  x1						
<b>K</b>  x1	<b>L</b>  x1	<b>M</b>  x1	<b>N<sub>1</sub></b>  x2	<b>N<sub>2</sub></b>  x2	<b>1</b> M6x10  x7	<b>2</b> M6x30  x4	<b>3</b> M6x40  x22	<b>4</b>  x6	<b>5</b>  x4	<b>6</b>  x1

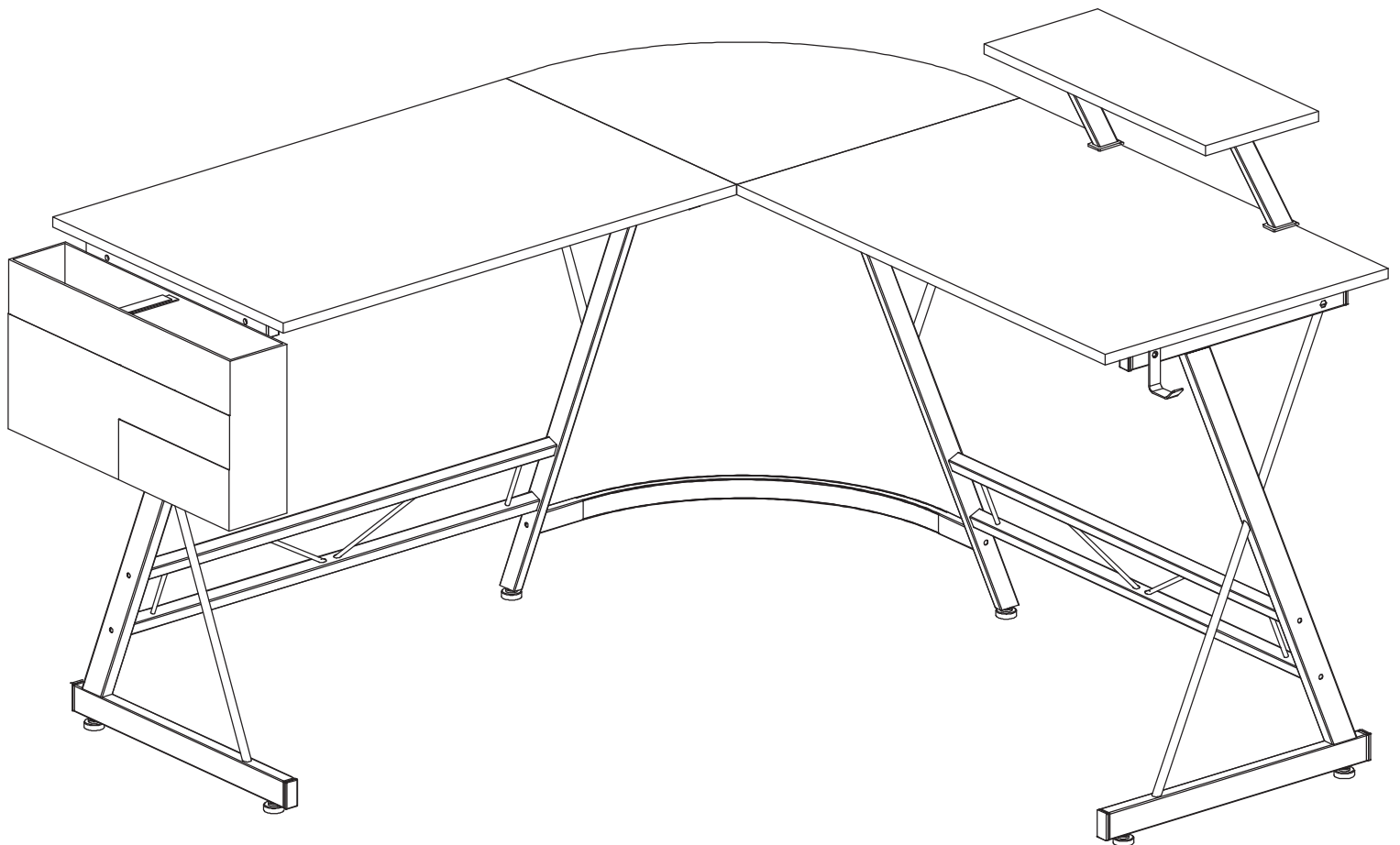

# Step 1

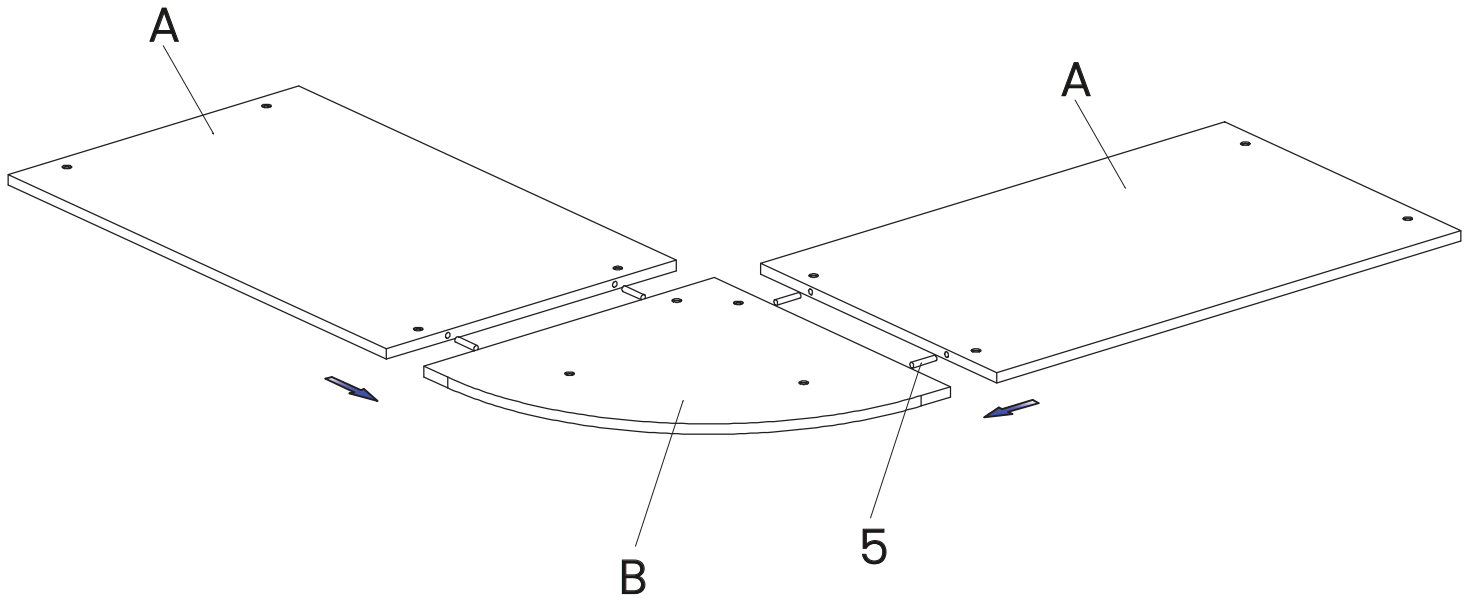

# Step 2

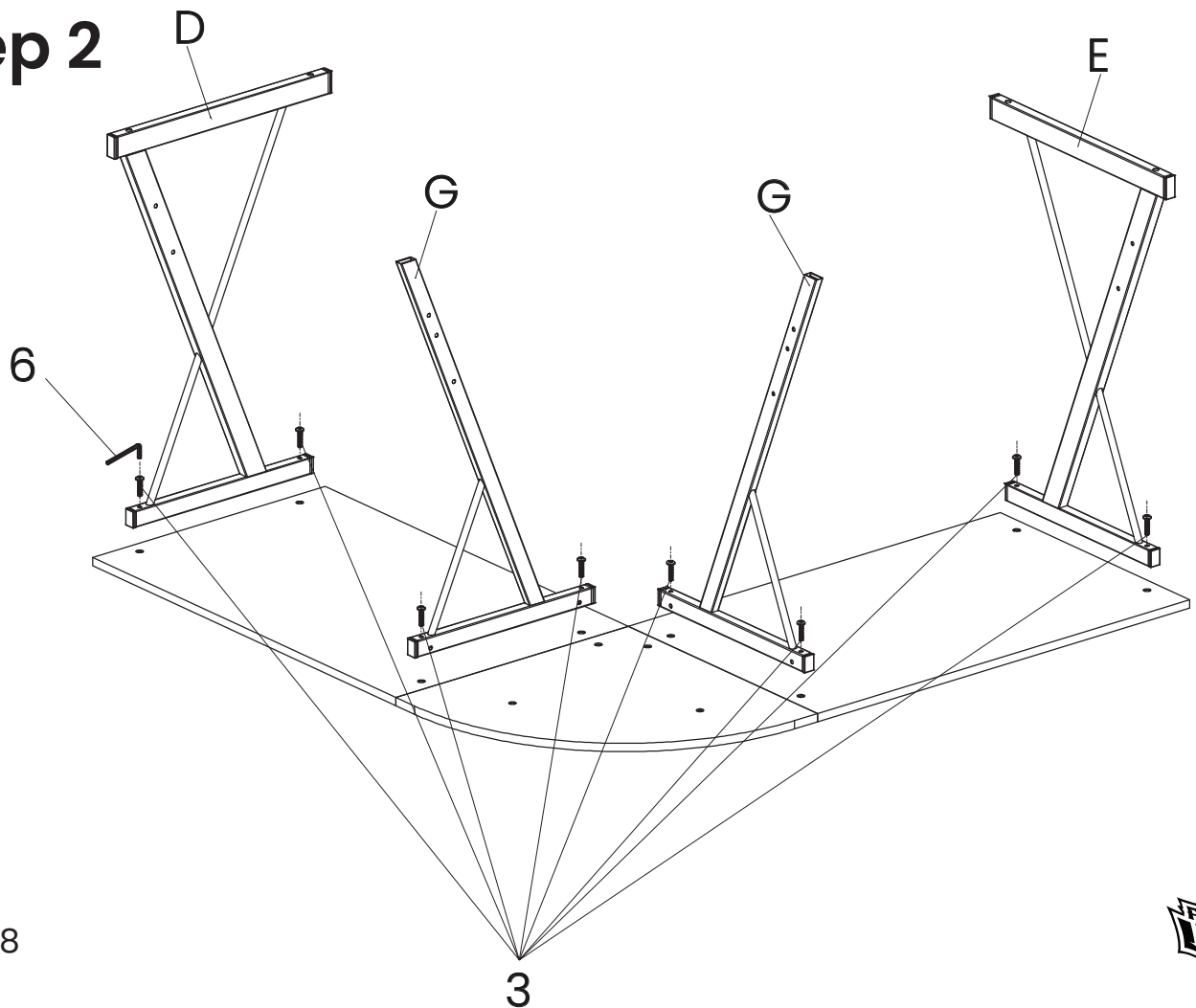

# Step 3

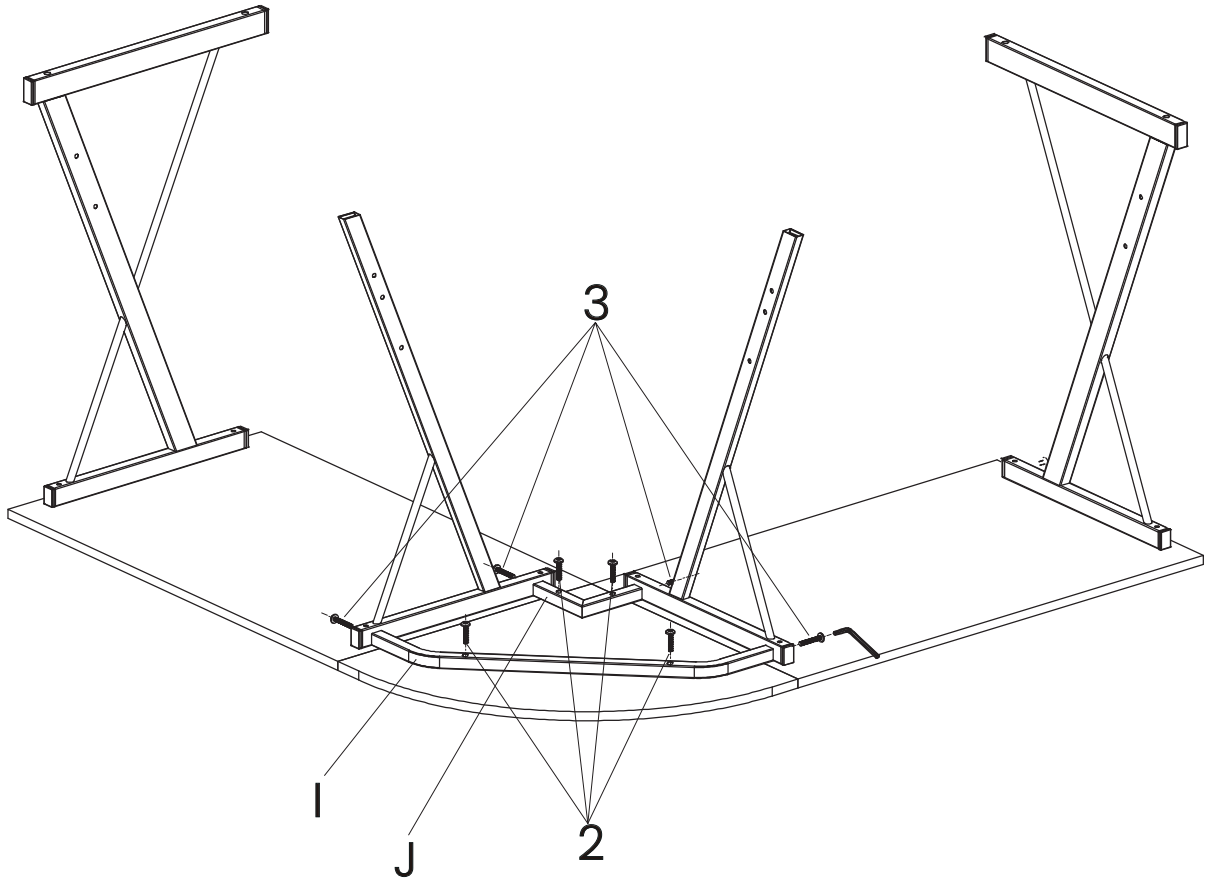

**2** x4  
**3** x4

# Step 4

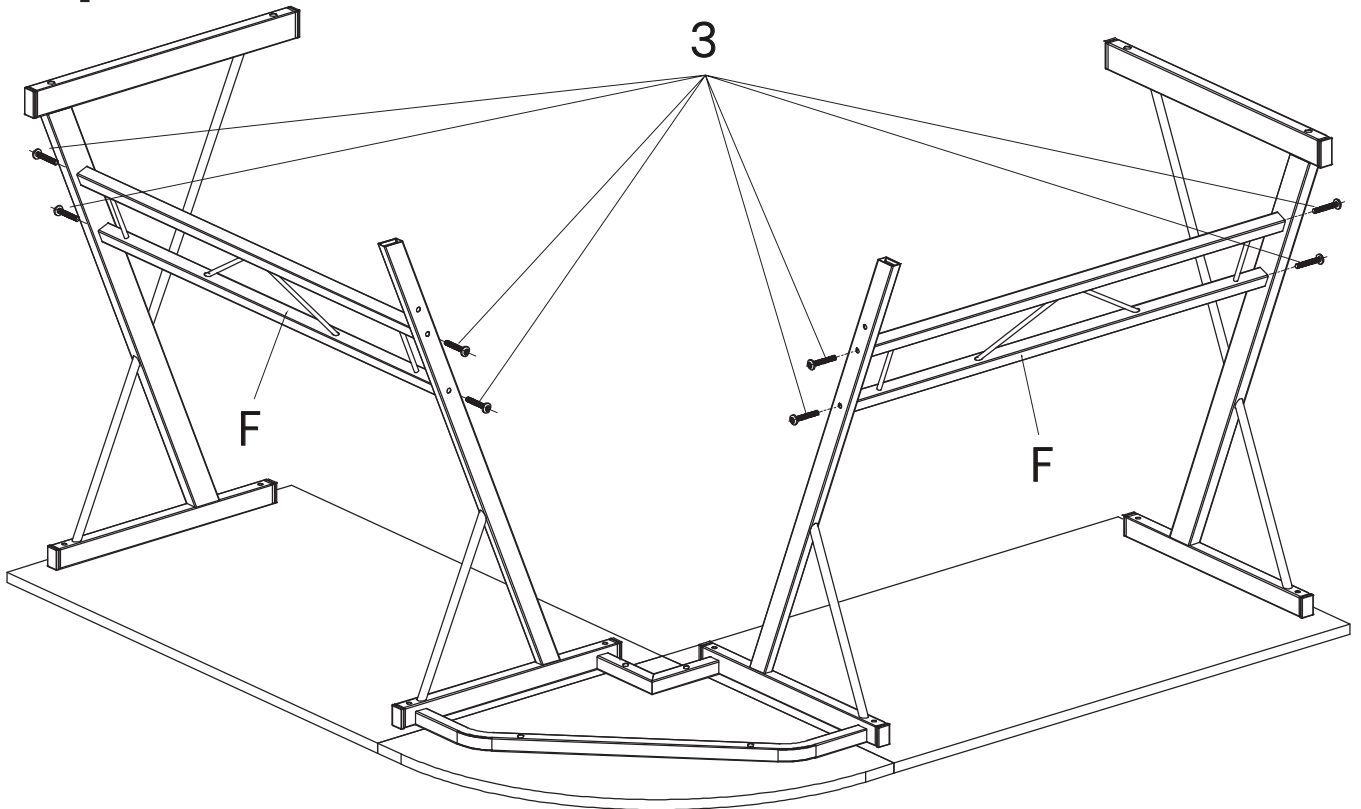

**3** x8



# Step 5

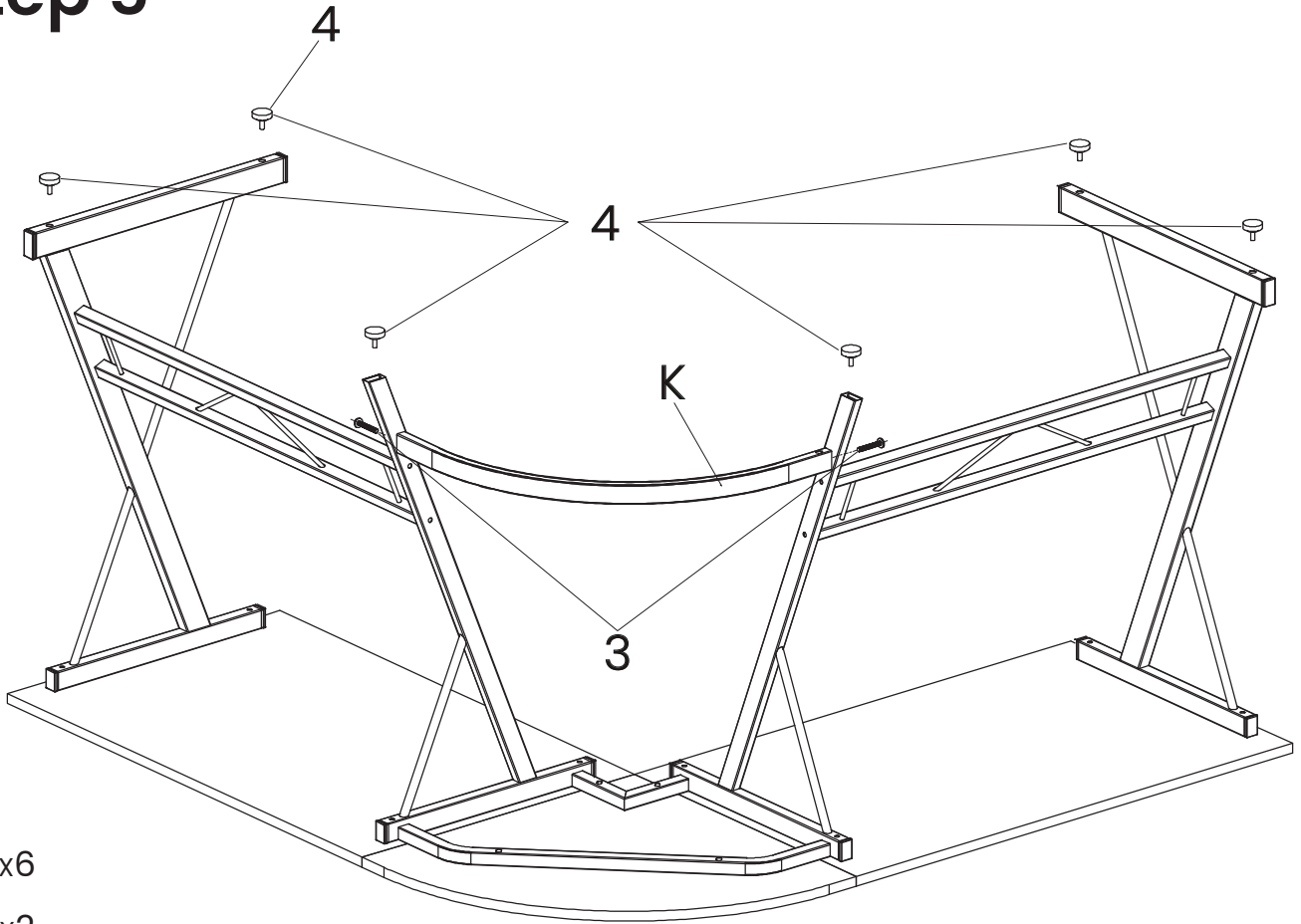

4 x6  
3 x2

# Step 6

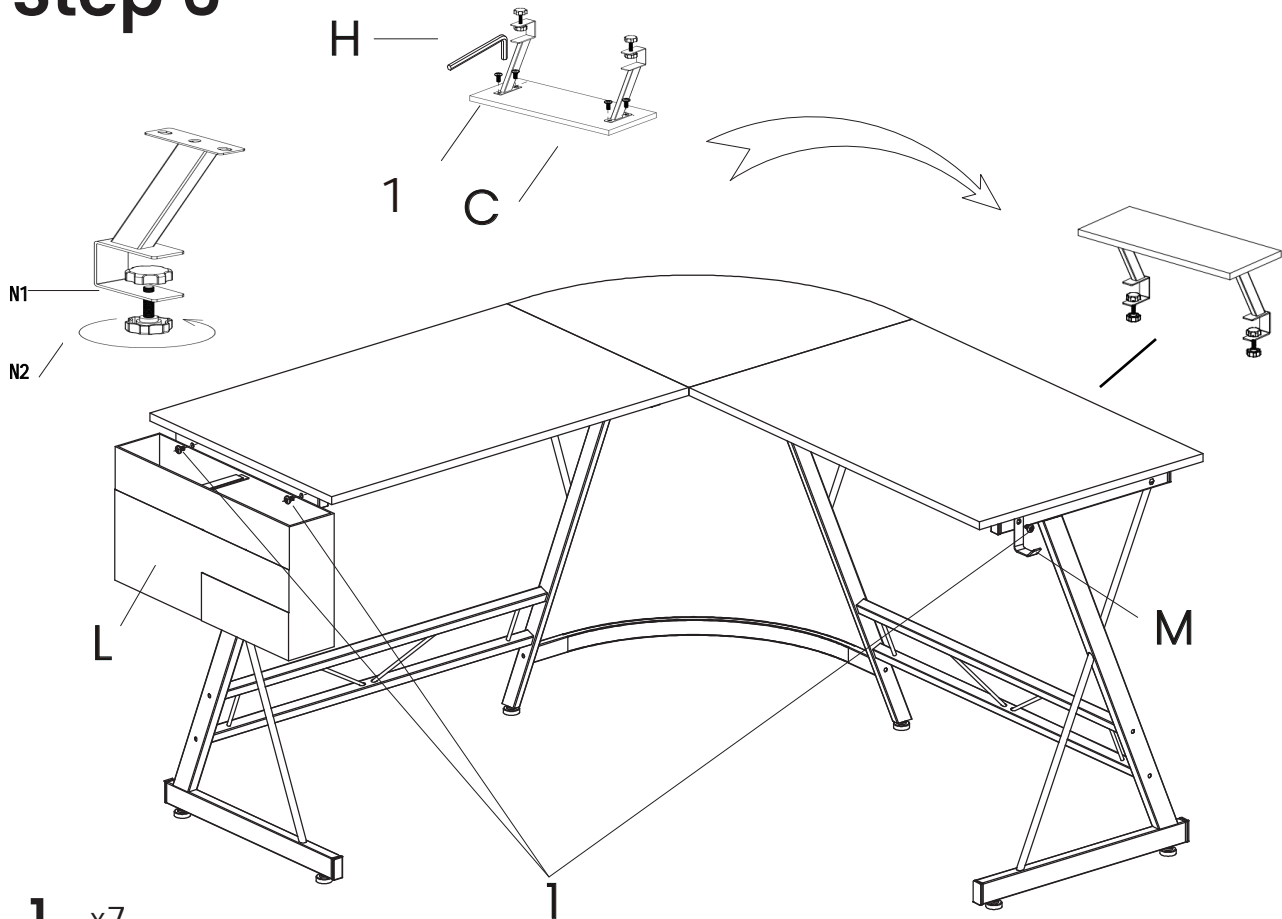

1 x7

# Step 7

