

CHIRPY COURT

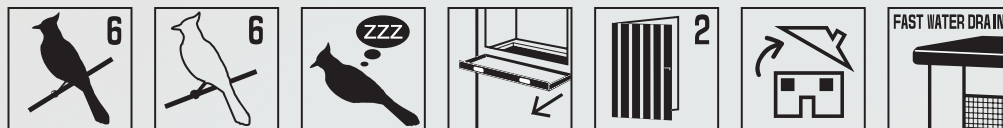

MANUAL

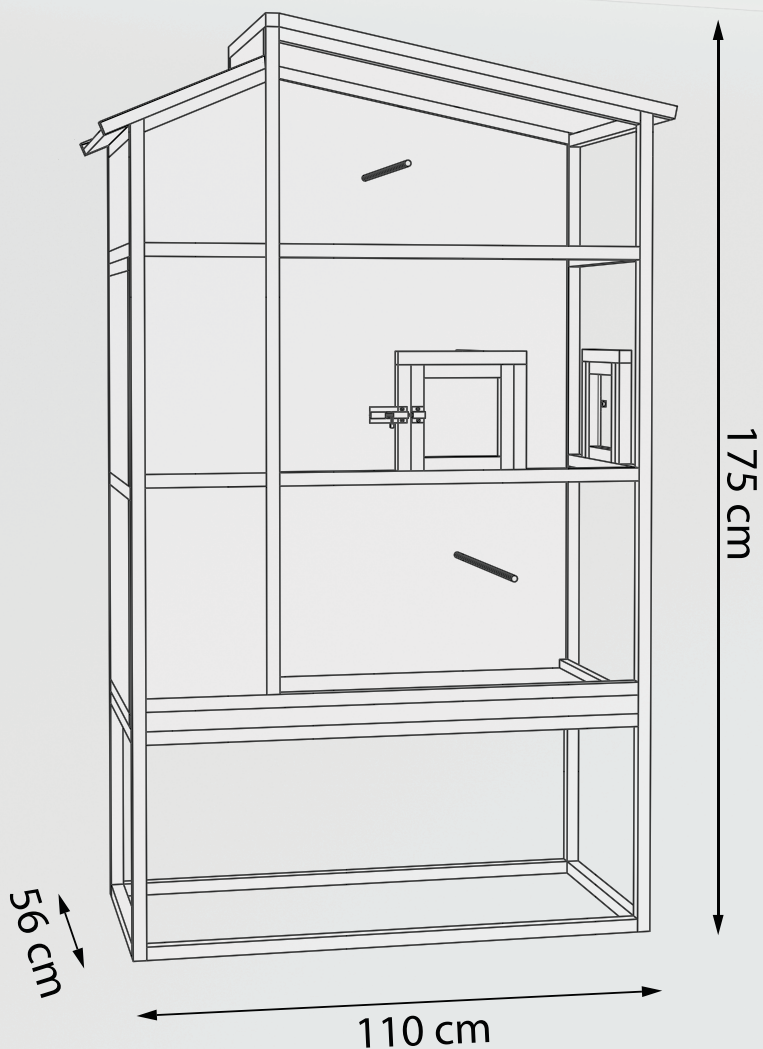

www.duvoplus.com

by





f @laroygroup

Questions? info@laroygroup.com

THESE PARTS:

FASTENERS

(A) 4+1 pcs - $\varnothing 3.5 \times 60$ mm 

(C) 8+1 pcs - $\varnothing 3.5 \times 35$ mm 

(E) 2 pcs - M5 \times 40mm 

(B) 20+1 pcs - $\varnothing 3.5 \times 45$ mm 

(D) 4+1 pcs - $\varnothing 3.5 \times 20$ mm 

(F) 1 pcs - 55 \times 45 mm 

WOOD PIECES

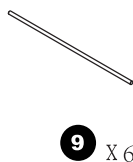
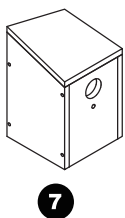
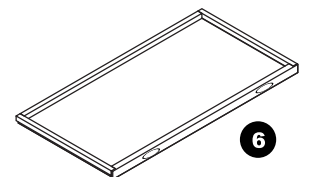
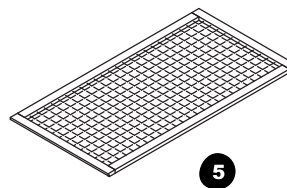
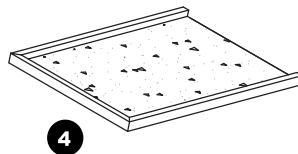
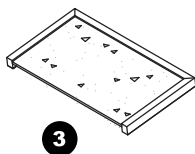
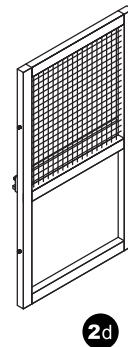
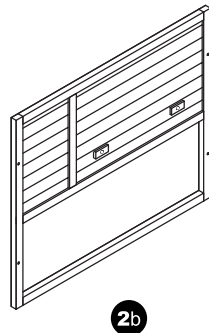
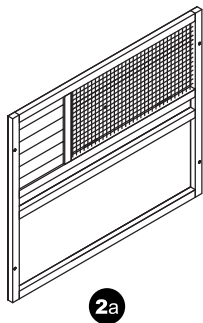
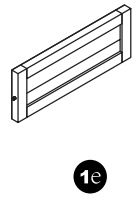
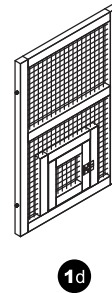
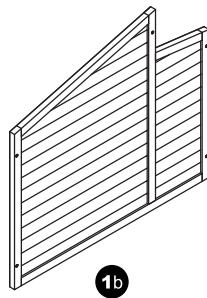
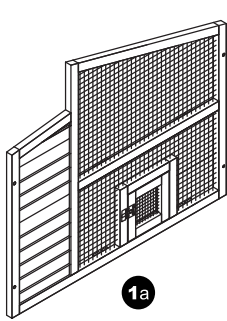

Assembly Instructions

*Use Screwdriver for Assembly

1

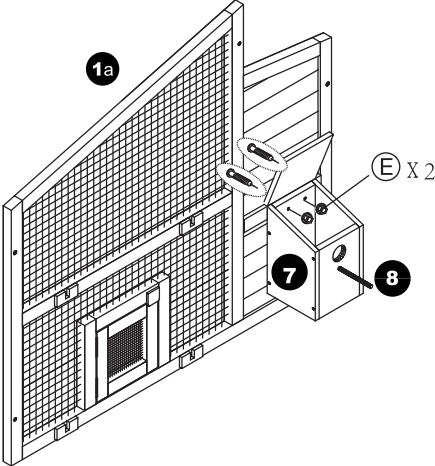

2

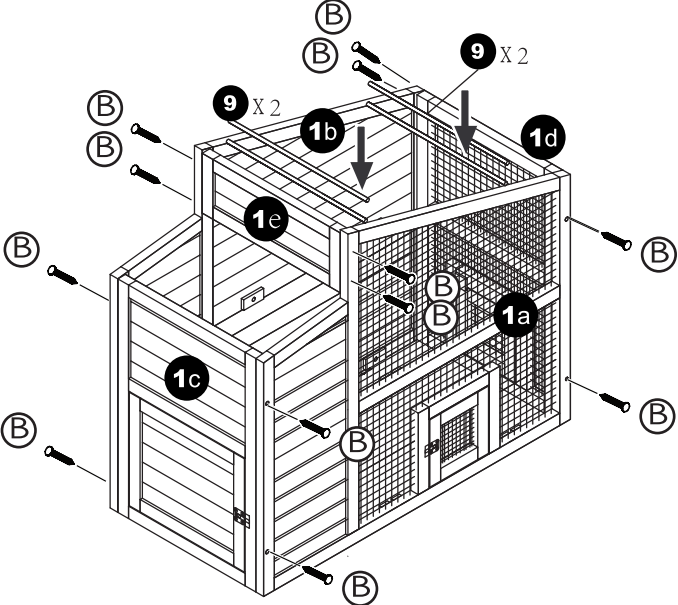

3

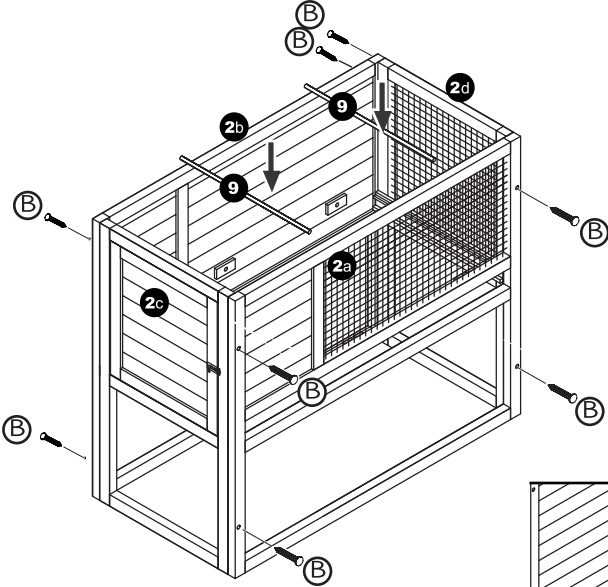

4

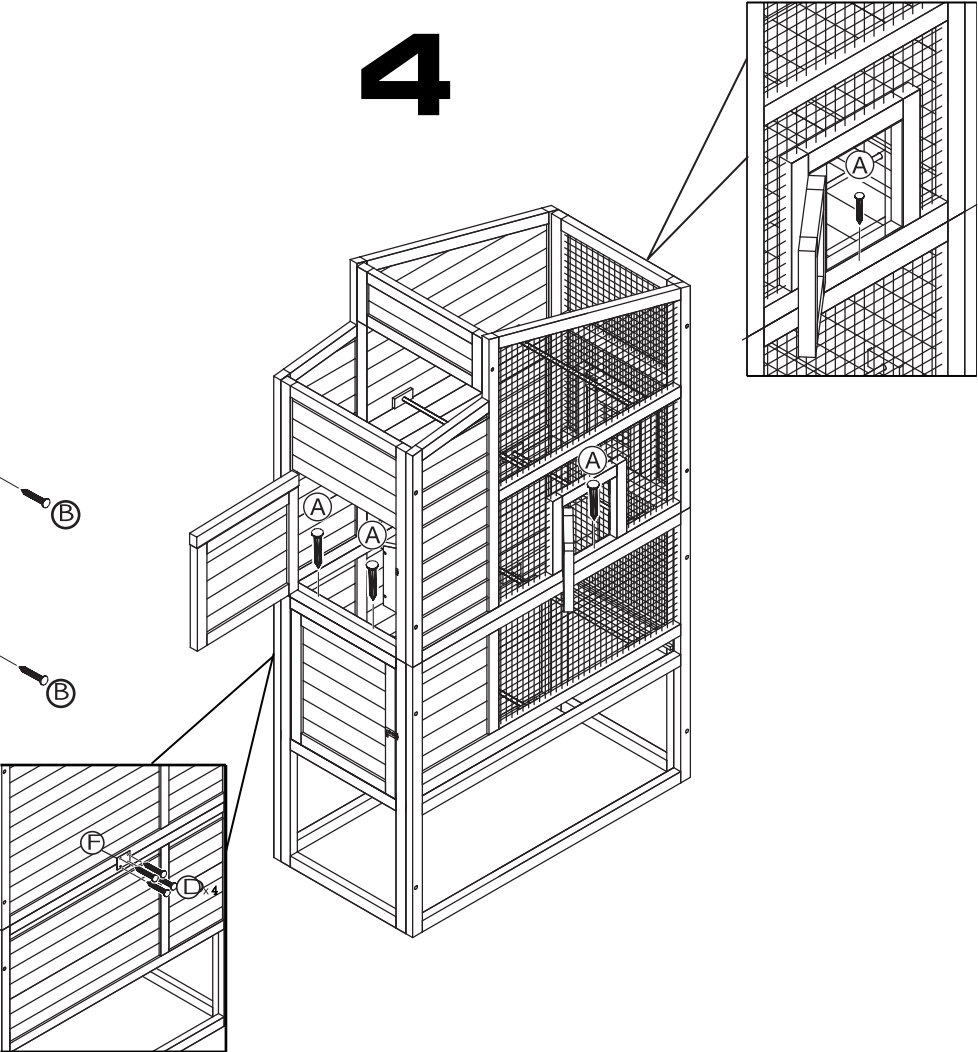

5

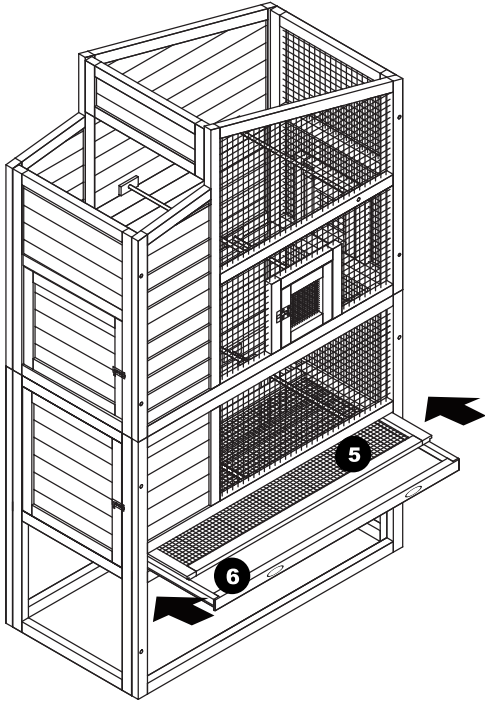

6

