

QUICK START

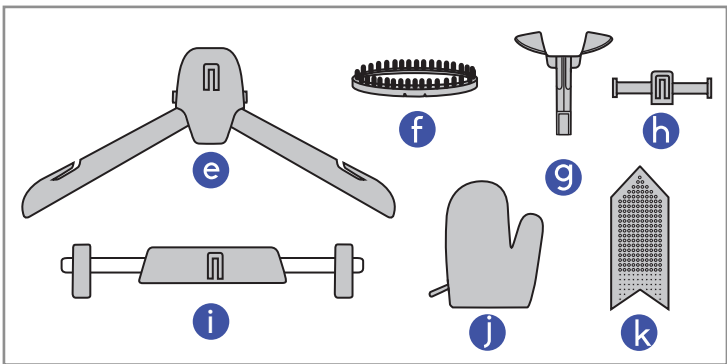

SteamOne

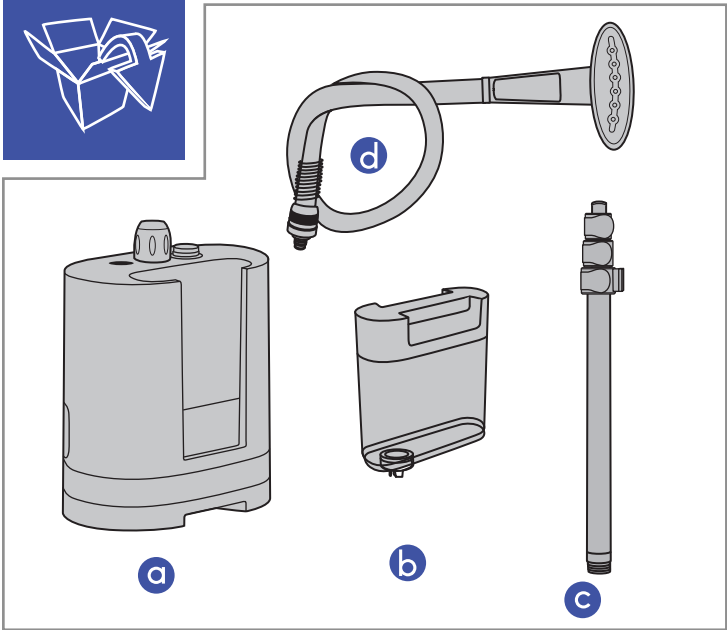

SteamOne

1

a + c

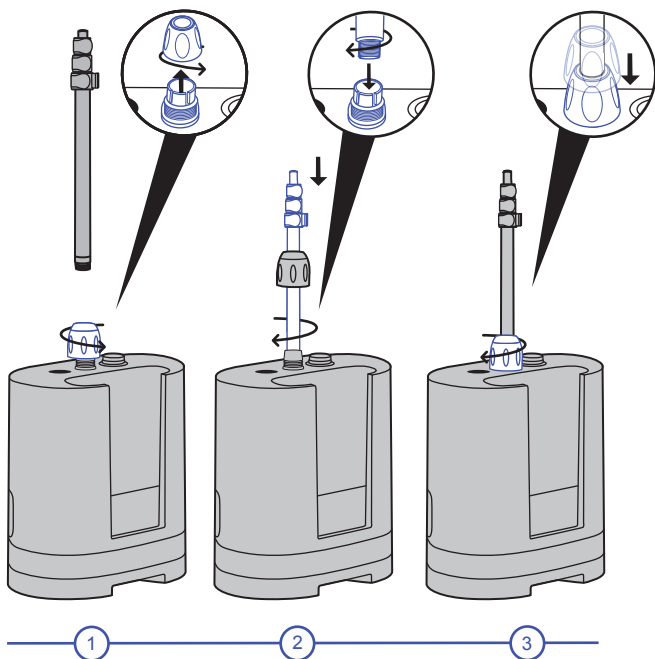

SteamOne

2

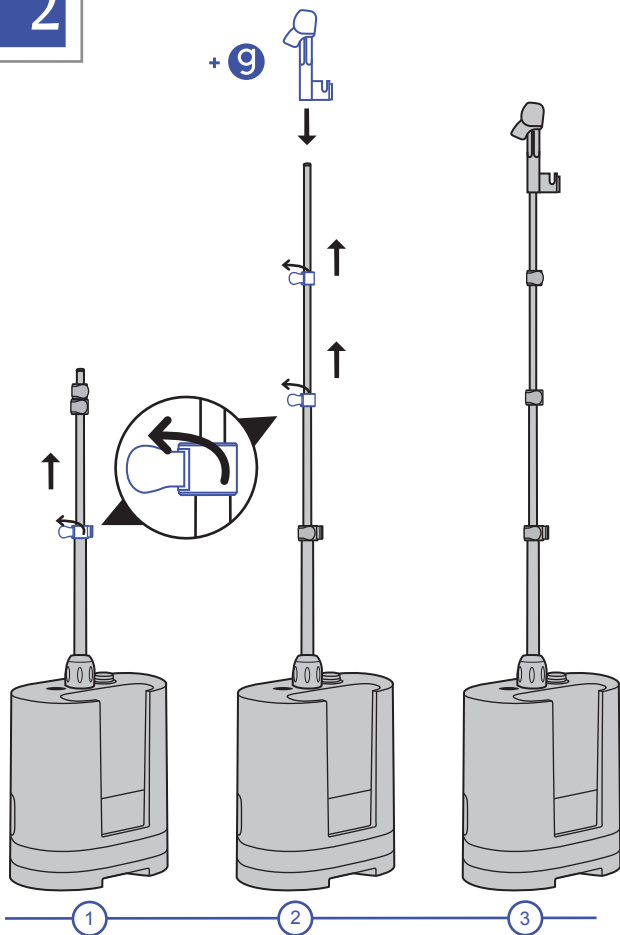

SteamOne

3

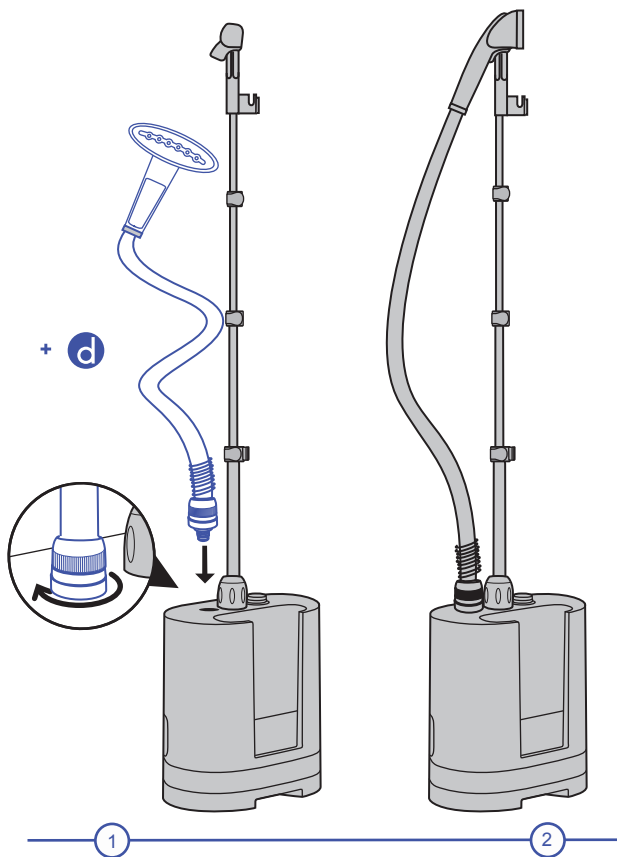

SteamOne

4

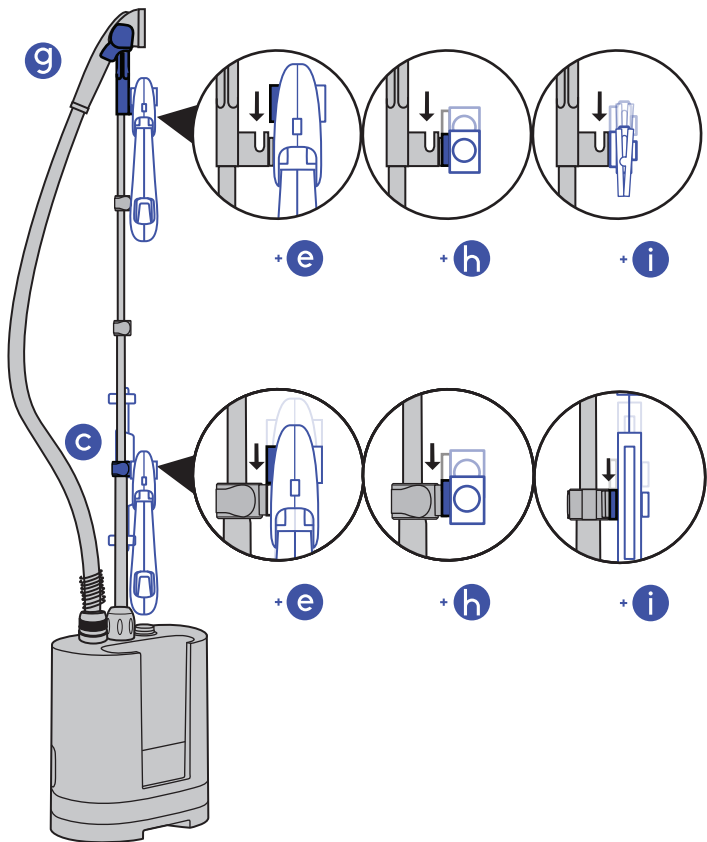

SteamOne

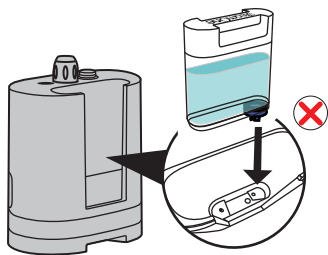
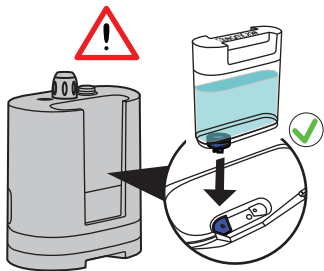
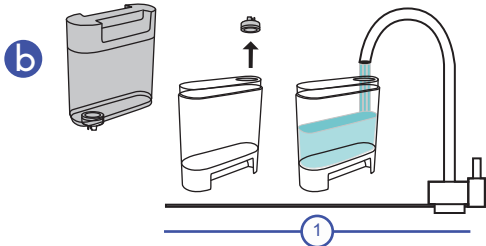
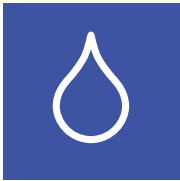

3

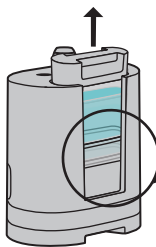

4

SteamOne

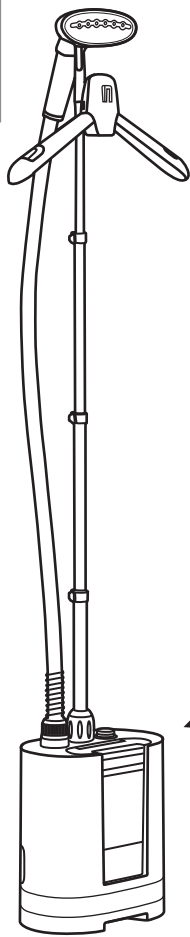

2

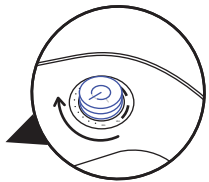

ON

1

SteamOne

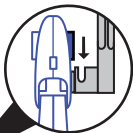

f + e

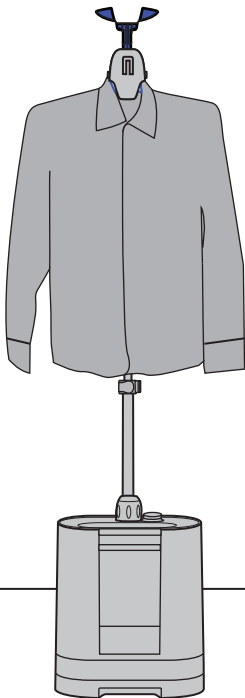
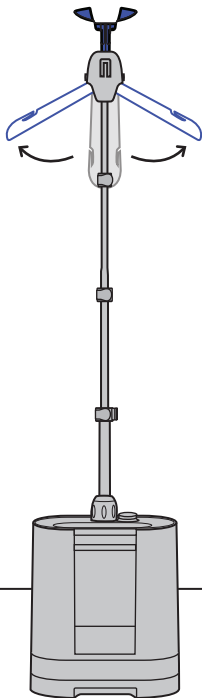
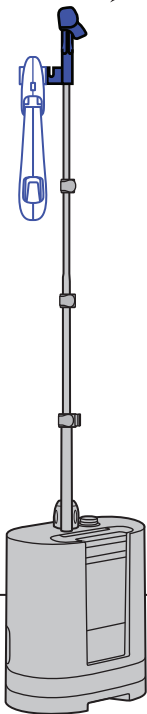

1

2

3

SteamOne

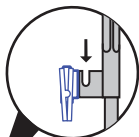

f + 9

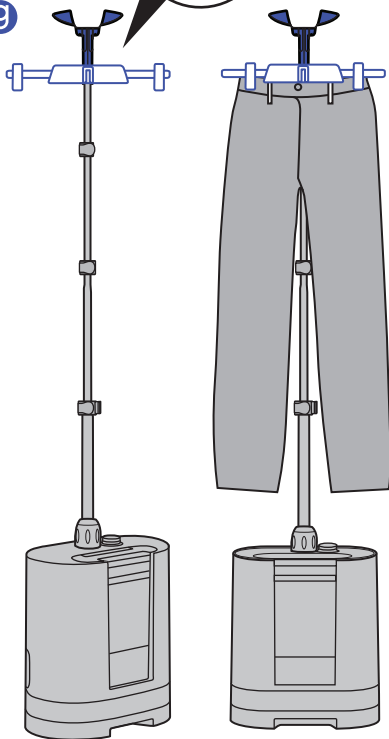

1

2

SteamOne



f + i

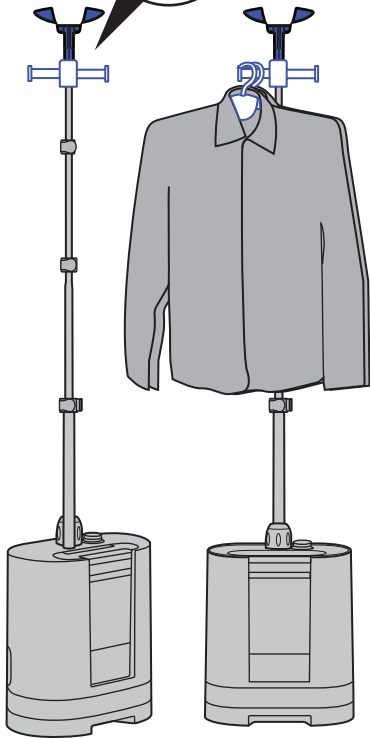
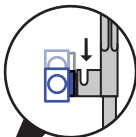

SteamOne

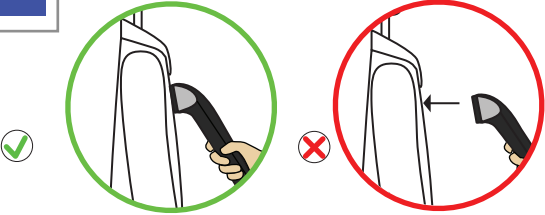

1

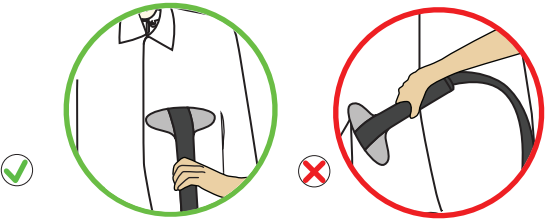

2

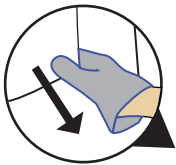

j

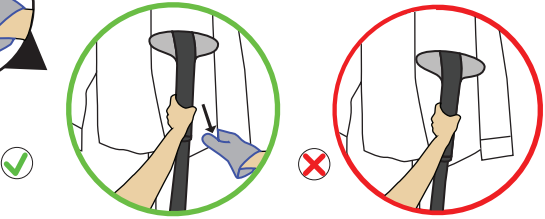

3

SteamOne



k

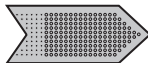

h



1

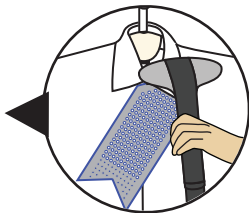

1

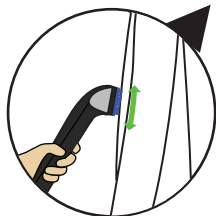

2

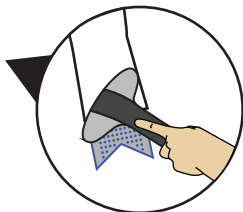

2

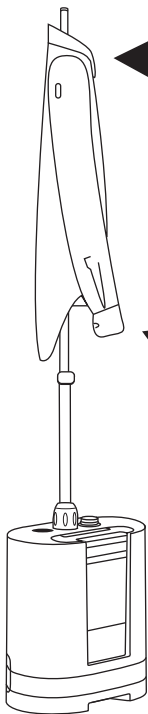

SteamOne

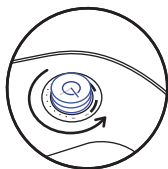

OFF



0

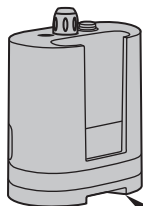

a

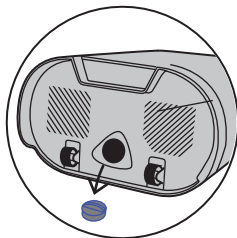
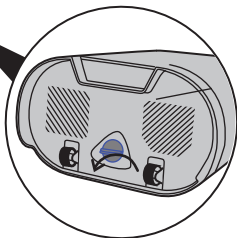

1

b

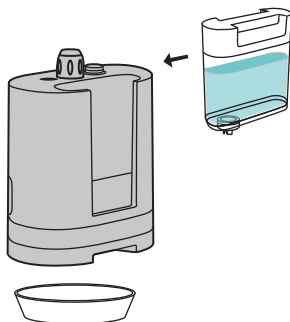
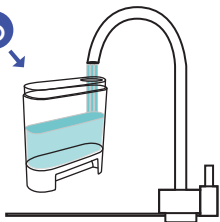

2

SteamOne

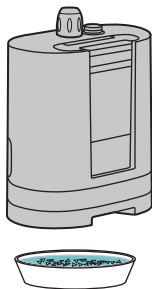
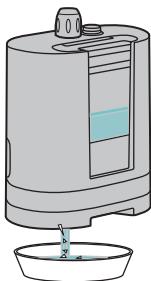

3

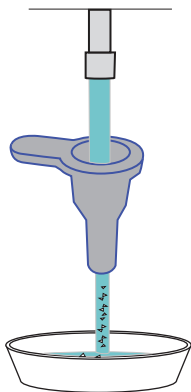
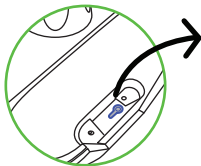
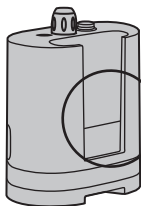

SteamOne

SteamOne

www.steam-one.com