Podec Bureaustoel



- EN** - Please read this instruction manual carefully before attempting to install.
DE - Bitte lesen Sie diese Bedienungsanleitung vor der Montage gründlich durch.
ES - Por favor lea con atención el manual de instrucciones antes de llevar a cabo el ensamble.
FR - Lisez attentivement cette notice avant de commencer le montage.
IT - Si prega di consultare il libretto delle istruzioni prima del montaggio.

IMPORTANT/WICHTIG/ATENCIÓN

IMPORTANT/IMPORTANTE



EN - We recommend **2** or more people to install.
DE - Wir empfehlen, dass die Montage von **2** oder mehreren Personen durchgeführt werden sollte.
ES - Recomendamos realizar el ensamble con **2** o más personas.
FR - Il est recommandé d'effectuer le montage à **2** personne(s) ou plus.
IT - È necessaria la presenza di **2** o più persone per il montaggio di questo prodotto.



EN - The expected assembly time is **1 h**.
DE - Die Montagezeit beträgt durchschnittlich **1 h**.
ES - El tiempo aproximado de ensamble es de **1 h**.
FR - Le temps nécessaire est estimé à **1 h**.
IT - Il tempo previsto per il corretto assemblaggio è di **1 h**.



EN - Not intended for use by children.
DE - Nicht geeignet für Kinder.
ES - Producto no apto para niños.
FR - Produit non destiné à être utilisé par des enfants.
IT - Questo prodotto non è destinato all'uso da parte dei bambini.



EN - Keep away from fire or other heat sources.
DE - Bitte von Feuer und Hitzequellen fernhalten.
ES - Manténgase alejado de las llamas y otras fuentes de calor.
FR - Tenir à distance des flammes et autres sources de chaleur.
IT - Tenere lontano dal fuoco o da altre fonti di calore.



EN - We recommend wearing protective gloves.
DE - Wir empfehlen das Tragen von Schutzhandschuhen.
ES - Recomendamos el uso de guantes de seguridad.
FR - Il est recommandé de porter des gants de protection.
IT - Per il processo di assemblaggio, consigliamo fortemente l'utilizzo di guanti protettivi.

EN - Please follow the instruction manuals and use a pad to avoid damage during assembly.









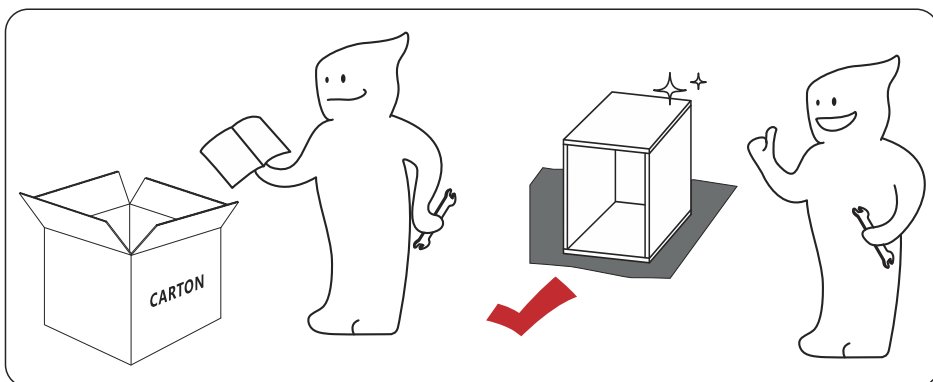
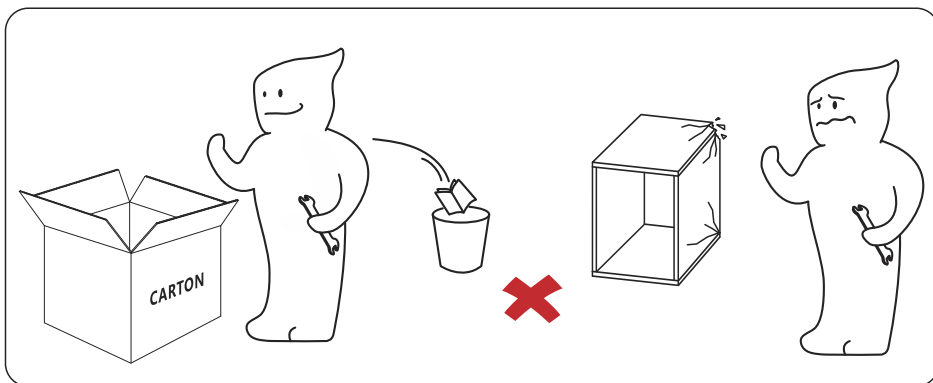



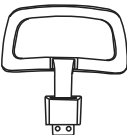
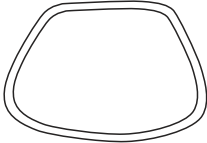
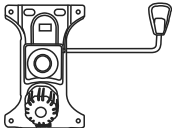

DE - Bitte folgen Sie der Anleitung und verwenden Sie eine Unterlage, um Beschädigungen bei der Montage zu vermeiden.

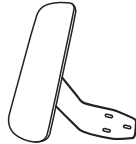
ES - Por favor siga las instrucciones del manual y utilice una cubierta o lona para proteger el producto y los suelos durante la instalación.





FR - Suivez les instructions de la notice et utilisez une couverture ou une bâche pour protéger le produit et les sols pendant le montage.

IT - Si prega di consultare il manuale illustrativo durante il montaggio e di utilizzare un cuscinetto per evitare possibili danni.



<p>① × 1</p> 	<p>② × 1</p> 	<p>③ × 1</p> 
<p>④ × 1</p> 	<p>⑤ × 1</p> 	<p>⑥ × 1</p> 
<p>⑦ × 1</p> 	<p>⑧ × 5</p> 	<p>⑨ × 1</p> 
<p>⑩ × 1</p> 	<p>Ⓐ × 8</p>  <p>35mm</p>	<p>Ⓑ × 4</p> 
<p>Ⓒ × 1</p> 	<p>Ⓓ × 10</p> 	<p>Ⓔ × 1</p>  <p>M4</p>
<p>Ⓕ × 1</p>  <p>M5</p>	<p>Ⓖ × 2</p>  <p>40mm</p>	

1



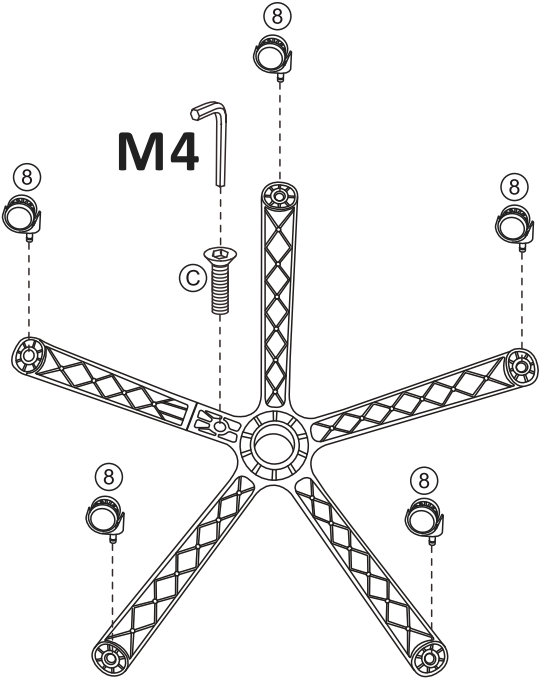
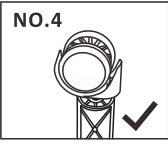
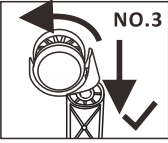
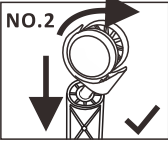
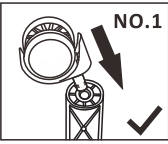
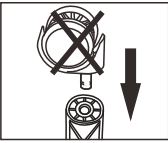
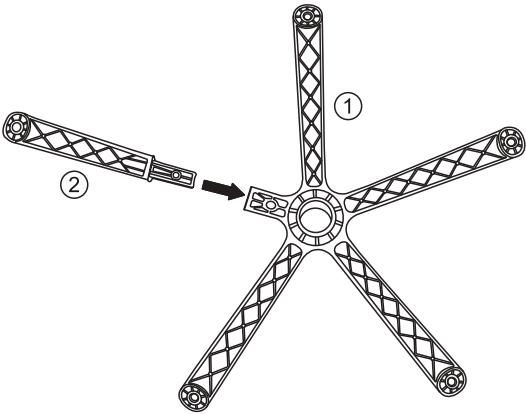

①		x1
②		x1
⑧		x5
Ⓒ		x1

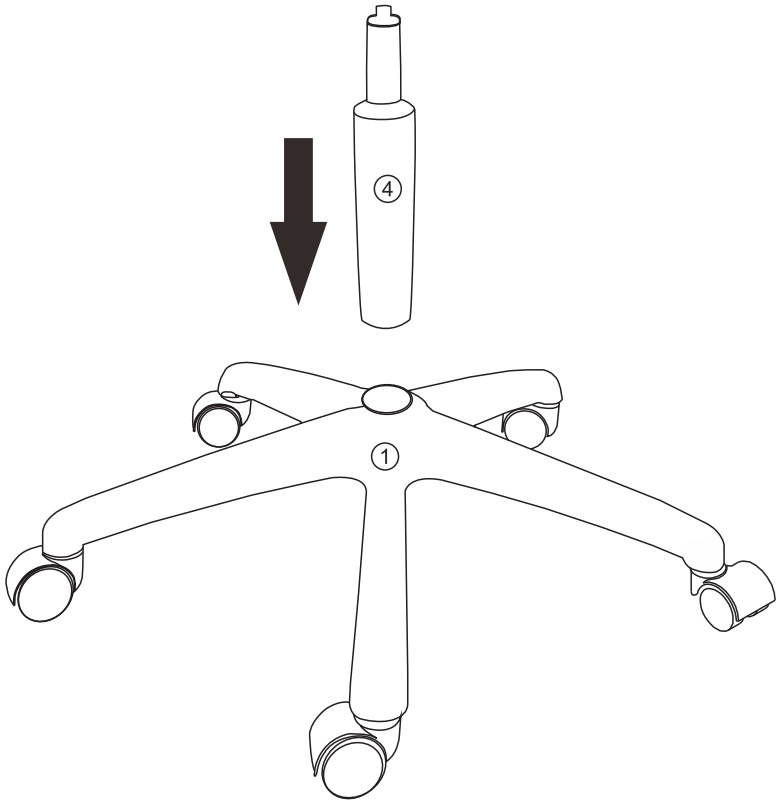
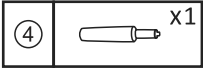

2



3

⑥		x1
⑨		x1
⑩		x1
Ⓐ		x6
Ⓓ		x6

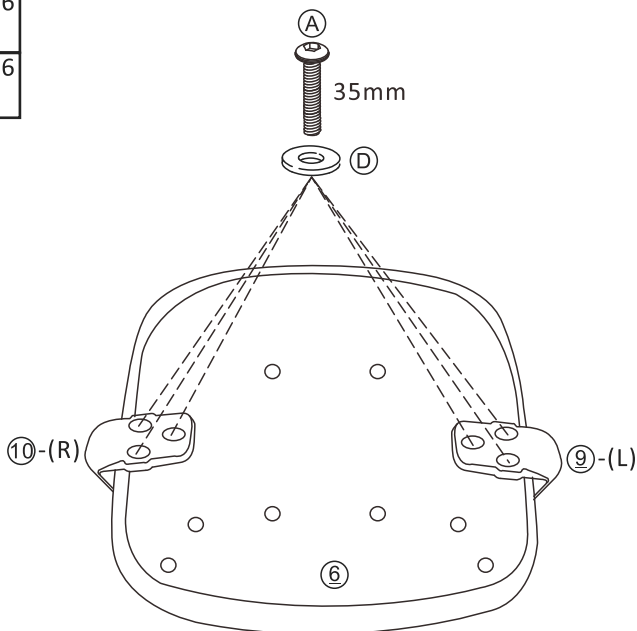

EN - During the assembly, please first half-tighten all the screws into the holes. After all the screws are set, fully tighten them.



DE - Bei der Montage ziehen Sie bitte zuerst alle Schrauben leicht von Hand fest. Erst nachdem alle Schrauben eingedreht sind, ziehen Sie diese dann vollständig mit dem Inbusschlüssel fest.

ES - Durante el montaje, apriete todos los tornillos sólo hasta la mitad. después de insertar todos los tornillos, apriételes completamente.

FR - Pendant le montage, il est recommandé de ne serrer les vis qu'à demi. Ne vissez à fond qu'une fois toutes les vis insérées.

IT - Durante il montaggio, si prega di stringere tutte le viti solo a metà. Solamente dopo aver inserito tutte le viti, stringerle completamente.

4

⑦		x1
Ⓑ		x4

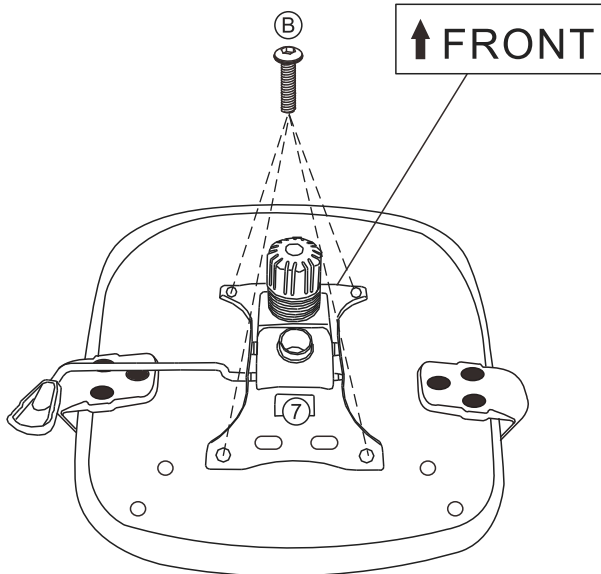

EN - During the assembly, please first half-tighten all the screws into the holes. After all the screws are set, fully tighten them.





DE - Bei der Montage ziehen Sie bitte zuerst alle Schrauben leicht von Hand fest. Erst nachdem alle Schrauben eingedreht sind, ziehen Sie diese dann vollständig mit dem Inbusschlüssel fest.

ES - Durante el montaje, apriete todos los tornillos sólo hasta la mitad. después de insertar todos los tornillos, apriételes completamente.

FR - Pendant le montage, il est recommandé de ne serrer les vis qu'à demi. Ne vissez à fond qu'une fois toutes les vis insérées.

IT - Durante il montaggio, si prega di stringere tutte le viti solo a metà. Solamente dopo aver inserito tutte le viti, stringerle completamente.

5

③		x1
Ⓐ		x2
Ⓓ		x4
Ⓒ		x2

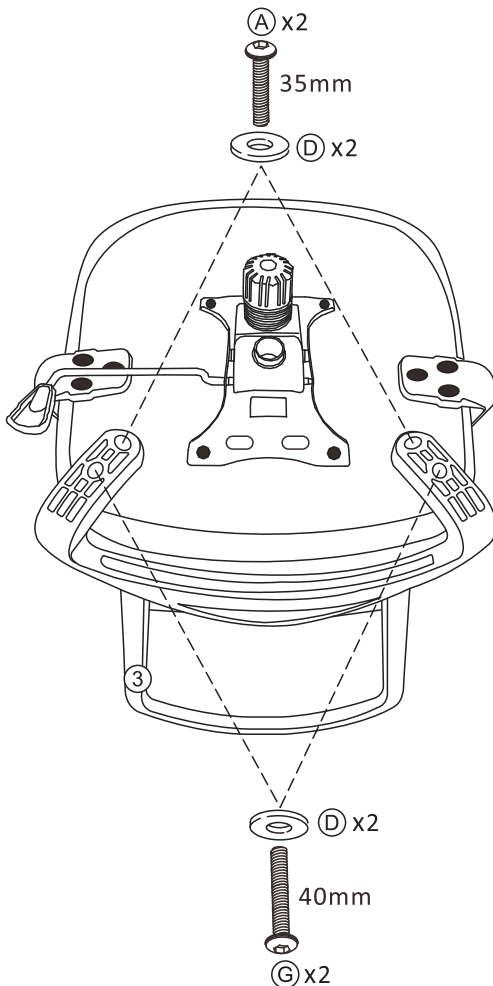

EN - During the assembly, please first half-tighten all the screws into the holes. After all the screws are set, fully tighten them.

DE - Bei der Montage ziehen Sie bitte zuerst alle Schrauben leicht von Hand fest. Erst nachdem alle Schrauben eingedreht sind, ziehen Sie diese dann vollständig mit dem Inbusschlüssel fest.

ES - Durante el montaje, apriete todos los tornillos sólo hasta la mitad. después de insertar todos los tornillos, apriételes completamente.

FR - Pendant le montage, il est recommandé de ne serrer les vis qu'à demi. Ne vissez à fond qu'une fois toutes les vis insérées.

IT - Durante il montaggio, si prega di stringere tutte le viti solo a metà. Solamente dopo aver inserito tutte le viti, stringerle completamente.

6

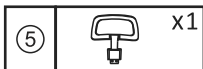

No.1

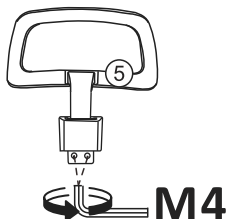

- EN** - Loosen the screws on the fixed clip of headrest (5) and remove the clip.
- DE** - Lösen Sie die Schrauben am festen Clip der Kopfstütze (5) und entfernen Sie den Clip.
- ES** - Afloje los tornillos de la parte inferior del reposacabezas (5) y retire el soporte.
- FR** - Détachez le clip de l'appui-tête (5) en desserrant les vis.
- IT** - Allentare le viti sulla chiusura fissa del poggiatesta e rimuovere il gancetto.

No.2

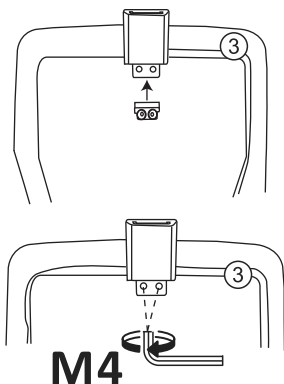

- EN** - Attach the clip to the back of the backrest and tighten all screws.
- DE** - Befestigen Sie den Clip an der Rückseite der Rückenlehne und ziehen Sie alle Schrauben fest.
- ES** - Acoplar el soporte a la parte posterior del respaldo y ajuste los tornillos.
- FR** - Fixez le clip derrière le dossier et serrez toutes les vis.
- IT** - Fissare il clip sul retro dello schienale e stringere tutte le viti.

No.3

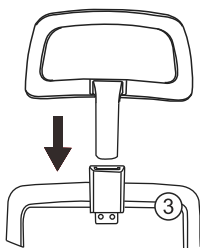

- EN** - Insert the headrest into the clip.
- DE** - Stecken Sie die Kopfstütze in den Clip.
- ES** - Introduzca el reposacabezas en el soporte.
- FR** - Insérez l'appui-tête dans le clip.
- IT** - Inserire il poggiatesta all'interno del clip.

7

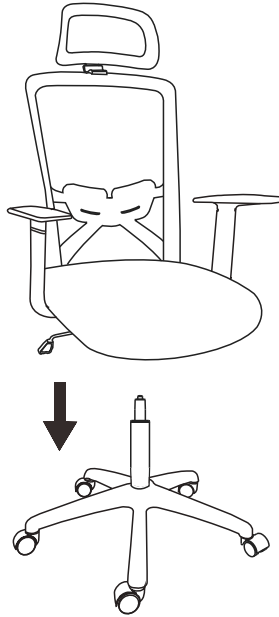

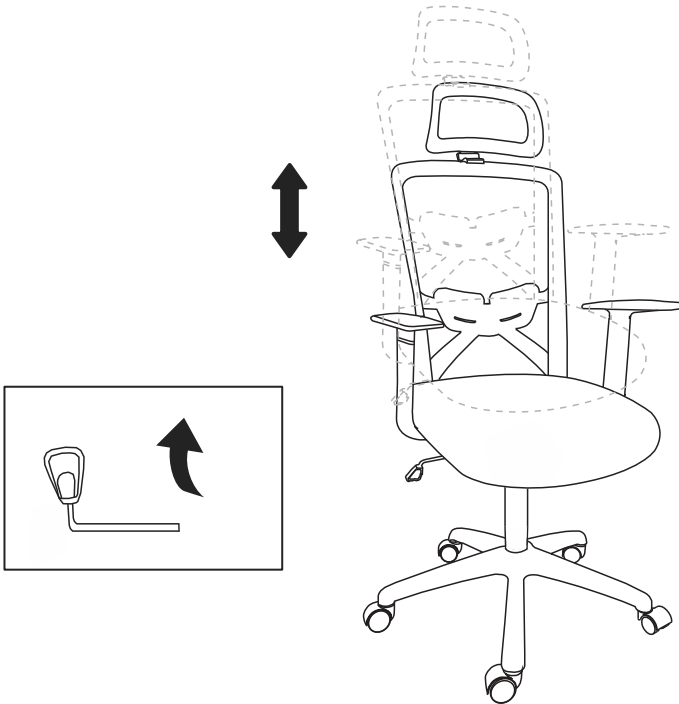

8



- EN** - When lowering down the seat height, please make sure to fully sit on the seat (as the right figure shows below) in order to give it enough pressure.
- DE** - Achten Sie beim Absenken der Sitzhöhe darauf, dass Sie vollständig auf den Sitz sitzen (wie auf der nachfolgenden rechten Abbildung gezeigt), um genügend Druck auf die Gasdruckfeder auszuüben.
- ES** - Al bajar la altura del asiento, asegúrese de sentarse completamente en él (como muestra la figura de la derecha) para ejercer suficiente presión.
- FR** - Pour abaisser le siège, veuillez à vous asseoir au fond du siège (comme sur le dessin de droite ci-dessous), pour exercer une pression suffisante.
- IT** - Per abbassare l'altezza del sedile, sedersi completamente su di esso (come mostra la figura in basso a destra) per assicurare abbastanza pressione.

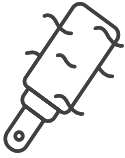

	<p>EN - Velvet Vacuum your piece monthly to keep the velvet looking like new. Use a nylon brush to remove any dirt or food. Contact a professional annually for a deep clean.</p> <p>DE - Samt Reinigen Sie den Samtbezug regelmäßig mit dem Staubsauger. Um größeren Schmutz zu entfernen, verwenden Sie bitte eine weiche Nylonbürste. Für eine Intensivreinigung empfehlen wir, einen professionellen Reinigungsdienst zu beauftragen.</p> <p>ES - Piel Aspire la pieza mensualmente para mantenerla como nueva. Utilice un cepillo de nylon para eliminar cualquier suciedad o comida. Póngase en contacto con un profesional anualmente para una limpieza profunda.</p> <p>FR - Velours Passez l'aspirateur sur le velours une fois par mois pour qu'il conserve l'aspect du neuf. Utilisez une brosse à textiles pour retirer la poussière ou les restes alimentaires. Faites effectuer une fois par an un nettoyage professionnel.</p> <p>IT - Velluto Passa l'aspirapolvere ogni mese per mantenere il velluto come nuovo. Usa una spazzola in nylon per rimuovere lo sporco. Rivolgiti alle agenzie di pulizia professionali per una pulizia profonda una volta l'anno.</p>
	<p>EN - Stubborn Stains Blot stains with a damp cloth and a dash of dish soap. Wipe away excess water with a clean towel. Let the material air-dry fully before use.</p> <p>DE - Hartnäckige Flecken Entfernen Sie Flecken vorsichtig mit einem feuchten Tuch und wenig Spülmittel. Überschüssiges Wasser zügig mit einem sauberen Handtuch abwischen. Und nach der Reinigung das Material gut trocknen lassen.</p> <p>ES - Manchas persistentes Remueva las manchas con un paño húmedo y una pizca de jabón para platos. Limpie el exceso de agua con una toalla limpia. Deje que el material se seque completamente al aire libre antes de utilizarlo.</p> <p>FR - Taches tenaces Tamponnez les taches avec un chiffon humide et un peu de liquide vaisselle. Essuyez l'excès d'eau avec un tissu propre. Laissez sécher complètement à l'air avant réutilisation.</p> <p>IT - Macchie resistenti Pulisci la macchia con un panno umido e un goccio di detersivo lavapiatti. Asciuga l'acqua in eccesso tramite un panno asciutto. Lascia che il materiale si asciughi completamente all'aria aperta prima dell'utilizzo.</p>

**EN - Additional Tips**

Vacuum to remove any loose crumbs or dirt.

Have a pet? Use a lint roller to gather up any fur.

DE - Zusätzliche Tipps:

Lose Krümmel, Schmutz oder Staub durch einfaches staubsaugen entfernen.

Haustierhaare können einfach mit Hilfe einer Fusselrolle entfernt werden.

ES - Extra tips

Aspire para eliminar las migas sueltas o la suciedad.

Tiene mascota? utilice un rodillo para pelusas para remover los cabellos.

FR - Autres conseils

Retirez à l'aide d'un aspirateur les miettes et saletés.

Si vous avez un animal, utilisez un rouleau anti-peluche pour ramasser les poils.

IT - Suggestimenti

Passa l'aspirapolvere per rimuovere ogni briciola rimasta o polvere.

Hai animali domestici? Usa una spazzola adesiva per raccogliere tutti i peli.

EN - Preventative Care

Rotate pillows and cushions monthly to ensure even wear.

Avoid placing your piece in direct sunlight to prevent fading.

Add a slipcover. Most are machine-washable and can change up your style!

DE - Vorbeugende Pflege

Durch regelmäßiges Wenden der Kissen und Polster können Sie eine vorzeitige Abnutzung vermeiden.

Vermeiden Sie, ihr Möbelstück direkter Sonneneinwirkung auszusetzen. Dies verhindert ein Ausbleichen des Stoffes.

Ein passender Schutzbezug verhindert starke Verschmutzung, ist zudem meist maschinenwaschbar und auch geeignet um den Stil zu verändern!

ES - Cuidados preventivos

Rotate las almohadas y los cojines mensualmente para asegurar un desgaste uniforme.

Evite colocar sus piezas bajo la luz directa del sol para evitar el deterioro.

Utilice una funda para cubrir. Las fundas pueden ser lavadas con máquina y pueden cambiar su estilo.

FR - Soins préventifs

Retournez les coussins une fois par mois pour une usure uniforme.

N'exposez pas votre produit à la lumière directe du soleil afin d'éviter une décoloration.

Ajoutez une housse: la plupart sont lavables en machine et vous permettent de changer de style.

IT - Prevenzione

Gira i cuscini mensilmente per evitare maggiore usura.

Si prega di evitare di porre il prodotto sotto la luce del sole, in modo da evitarne lo sbiadimento.

Aggiungi una fodera. La maggior parte delle fodere sono lavabili in lavatrici e possono migliorare il vostro stile.

EN

If you are not entirely satisfied with your purchase, please feel free to contact us using the following steps:

1. Go to Your Orders.
2. Find your order in the list.
3. Select Problem with order.
4. Choose your topic from list displayed.
5. Select Contact seller.

DE

Sollten Sie mit Ihrem Kauf nicht zufrieden sein, nehmen Sie bitte in folgenden Schritten mit uns Kontakt auf:

1. Gehen Sie auf die Bestellseite
 2. Suchen Sie Ihre Bestellung in der Bestellliste
 3. Schildern Sie das Problem mit der Bestellung
 4. Thema aus der angezeigten Liste auswählen
 5. Kontakt mit dem Verkäufer aufnehmen.
- Hergestellt in PRC für Yahee GmbH
 Importeur: Yahee GmbH
 Höpfigheimer Straße 11.7
 4321 Bietigheim-Bissingen

ES

Si no está totalmente satisfecho con su compra, no dude en ponerse en contacto con nosotros siguiendo las siguientes instrucciones:

1. Vaya a la lista de sus ordenes de compra.
2. Localice su pedido en la lista.
3. Seleccione el problema en el pedido.
4. Elija un tema de la lista que se muestra.
5. Seleccione Contactar con el vendedor.

FR

Si vous n'êtes pas satisfait de votre achat, veuillez nous contacter en procédant comme suit :

1. Allez sur "Vos commandes"
2. Trouvez votre commande dans la liste.
3. Cliquez sur "Signaler un problème"
4. Sélectionnez une catégorie dans la liste déroulante.
5. Cliquez sur "Contactez le vendeur"

IT

Se non siete soddisfatti di questa esperienza dello shopping, non esitate a contattarci per i seguenti passaggi:

1. Vai ai tuoi ordini.
2. Selezionare "l'ordine interessato".
3. Selezionare il problema con l'ordine.
4. Scegli il tuo argomento dalla lista visualizzata.
5. Selezionare "contatta il venditore".

EN - You can also download the electronic Installation Manual from the Product guides and documents section of the advertising page.

DE - Das elektronische Installationshandbuch können Sie auch im Bereich Produktführungen und Dokumente der Werbeseite herunterladen.

ES - También puede descargar el Manual de instalación electrónica de la Guía del producto y la Sección de documentación de la página de anuncios.

FR - Vous pouvez également télécharger le manuel d'installation électronique à partir de la section Guide produit et documentation de la page publicitaire.

IT - È inoltre possibile scaricare il manuale di installazione elettronico dalla guida del prodotto e dai documenti nella pagina pubblicitaria.