

# Cuisinart® INSTRUCTION BOOKLET

Recipe  
Booklet  
Reverse Side



**14-Cup Cuisinart Elite Collection™ Food Processor**

**FP-14 Series**

For your safety and continued enjoyment of this product, always read the instruction book carefully before using.

# RECOMMENDED MAXIMUM WORK BOWL CAPACITIES

FOOD	CAPACITY 14-CUP WORKBOWL	CAPACITY 11-CUP WORKBOWL	CAPACITY 4.5-CUP WORKBOWL
Sliced or shredded fruit, vegetables or cheese	14 cups	11 cups	N/A
Chopped fruit, vegetables or cheese	12 cups	9 cups	3 cups
Puréed fruit, vegetables or cheese	12 cups cooked 8 cups puréed	8 cups cooked 6 cups puréed	3 cups cooked 1½ cups puréed
Chopped or puréed meat, fish, seafood	2¼ pounds	2 pounds	½ pound
Thin liquid* (e.g. dressing, soups, etc.)	10 cups	8 cups	3 cups
Cake Batter	Two 9-inch cheesecakes Four 8-inch homemade layers (2 boxes 18.5 oz. cake mix)	One 9-inch cheesecake Two 8-inch homemade layers (1 box)	N/A
Cookie dough	8 dozen (based on average chocolate chip cookie recipe)	N/A	N/A
White bread dough	6 cups flour	N/A	N/A
Whole wheat bread dough	4 cups flour	N/A	N/A
Nuts for nut butter	7 cups	5 cups	1½ cups

\* When processing egg-based liquids, like a custard base for quiche, reduce maximum capacity by 2 cups.

# IMPORTANT UNPACKING INSTRUCTIONS

This package contains a Cuisinart Elite Collection™ 14-Cup Food Processor and the accessories for it:

14-, 11- and 4.5-cup work bowls, work bowl cover, metal chopping/mixing blade, dough blade, adjustable slicing disc, reversible shedding disc, stem adapter, large and small pushers, spatula, accessory storage case, instruction/recipe book and How-to DVD.

## CAUTION:

**THE CUTTING TOOLS HAVE VERY SHARP EDGES.** To avoid injury when unpacking the parts, please follow these instructions.

1. Place the box on a low table or on the floor next to the kitchen counter where you intend to keep the food processor. Be sure the box is right side up.
2. Open top flaps—there will be a rectangular block of foam that holds the processor parts, each fitted into a cavity in the foam.
3. Remove the instruction/recipe book, the spatula (A) is on one side of the foam block.
4. Remove the bowl cover (B) from the other side of the foam block. Lift out the large and small pushers with cover (C) from their space under the bowl cover in the foam block.
5. Lift out the DVD from its space in the foam block.
6. Lift out the foam block and the cardboard frame.
7. The housing base with 14-, 11- and 4.5-cup work bowls are on one side of the bottom of the box.
8. Remove the base and bowls together by grasping the handle and lifting straight up. Do not rotate the bowl clockwise on the base. This will cause the bowl to separate from the base.
9. Place the food processor on the counter or table. Read the instructions thoroughly before using the machine.
10. The storage case is on the other side of the bottom of the box.
11. Lift out the storage case, unlock the cover and remove the foam block; small metal

chopping/mixing blade (D), dough blade (E), large metal chopping/mixing blade (F), and stem adapter (G), are each in a cavity. **CAREFULLY REMOVE THE METAL CHOPPING/MIXING BLADE BY GRASPING THE CENTER WHITE HUB AND LIFTING IT STRAIGHT UP. NEVER TOUCH THE BLADES, AS THEY ARE RAZOR SHARP.**

12. Pull out the drawer to the storage case with the adjustable slicing disc (H), and **CAREFULLY REMOVE IT BY USING THE FINGER HOLES. DO NOT TOUCH THE BLADE, IT IS VERY SHARP.** The reversible shredding disc (I) is also in the drawer. Carefully remove the slicing disc by using the finger holes and carefully remove the shredding disc by using the plastic hub. Remember to lock the parts in the storage case when not in use.
13. Save the shipping cartons and plastic foam blocks. You will find them very useful if you need to repack the processor for moving or other shipment.

**Please watch the enclosed How-to DVD before using the food processor.**

**NOTE:** Remember to return your completed product registration card with all information carefully filled out.

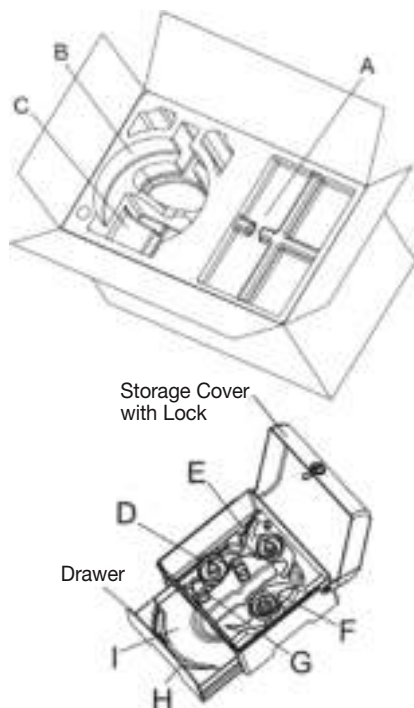

---

# IMPORTANT SAFEGUARDS

Always follow these safety precautions when using this appliance.

## Getting Ready

1. Read all instructions.
2. **Blades and discs are sharp.** Handle them carefully.
3. **Always unplug from outlet when not in use, before putting on or taking off parts, before removing food and before cleaning. To unplug, grasp plug and pull from electrical outlet. Never pull cord.**
4. Do not use outdoors.
5. Do not let cord hang over edge of table or counter, or touch hot surfaces.
6. Do not operate any appliance with damaged cord or plug, or after appliance has been dropped or damaged in any way. Return appliance to the nearest authorized service facility for examination, repair or electrical or mechanical adjustment.

## Operation

1. Keep hands as well as spatulas and other utensils away from moving blades or discs while processing food, to prevent the possibility of severe personal injury or damage to food processor. A plastic scraper may be used, but only when the food processor motor is stopped.
2. Avoid contact with moving parts. Never push food down by hand when slicing or shredding. Always use pusher.
3. Make sure motor has completely stopped before removing cover. (If machine does not stop within 4 seconds after you remove the pusher assembly, call 1-800-762-0190 for assistance. Do not use the machine.)
4. Never store any blade or disc on motor shaft. To reduce the risk of injury, no blade or disc should be placed on the shaft except when the bowl is properly locked in place and the processor is in use. Store blades and discs, as you would sharp knives, out of reach of children.
5. Be sure cover and feed tube are securely locked in place before operating food processor.
6. Never try to override or tamper with cover interlock mechanism.

## Cleaning

To protect against risk of electrical shock, do not put base in water or other liquid.

## General

1. This appliance should not be used by or near children or individuals with certain disabilities.
2. Do not operate this, or any other motor-driven appliance, while under the influence of alcohol or other substances that affect your reaction time or perception.
3. This food processor is UL listed for household use. Use it only for food preparation as described in the accompanying recipe and instruction book. Do not use this appliance outside of its intended use.
4. The use of attachments not recommended or sold by Cuisinart may cause fire, electrical shock or personal injury, or damage to your food processor.
5. To avoid possible malfunction of work bowl switch, never store processor with pusher assembly in locked position.
6. Maximum rating of 7 amperes is based on attachment that draws greatest current. Other recommended attachments may draw significantly less current.

**NOTICE:** If your food processor has a plastic case, it has a polarized plug (one blade is wider than the other). As a safety feature, this plug will fit in a polarized outlet only one way. If the plug does not fit fully in the outlet, reverse the plug. If it still does not fit, contact a qualified electrician. Do not attempt to defeat this safety feature.

# SAVE THESE INSTRUCTIONS FOR HOUSEHOLD USE ONLY

# WARNING: RISK OF FIRE OR ELECTRIC SHOCK



The lightning flash with arrowhead symbol within an equilateral triangle is intended to alert the user to the presence of un-insulated dangerous voltage within the product's enclosure that may be of sufficient magnitude to constitute a risk of fire or electric shock to persons.



The exclamation point within an equilateral triangle is intended to alert the user to the presence of important operating and maintenance (servicing) instructions in the literature accompanying the appliance.

## SPECIAL CORD SET INSTRUCTIONS

### NOTICE

If you have a die-cast metal unit, for your protection, it is equipped with a 3-conductor cord set that has a molded 3-prong grounding-type plug, and should be used in combination with a properly connected grounding-type outlet as shown in Figure A.

If a grounding-type outlet is not available, an adapter, shown in Figure B, may be obtained so that a 2-slot wall outlet can be used with a 3-prong plug. As shown in Figure C, the adapter must be grounded by attaching its grounding lug under the screw of the outlet cover plate.

**NOTE: Do not remove the grounding prong.**

**CAUTION: Before using an adapter, it must be determined that the outlet cover plate screw is properly grounded. If in doubt, consult a licensed electrician. Never use an adapter unless you are sure it is properly grounded.**

**Note: Use of an adapter is not permitted in Canada.**

## CONTENTS

Important Unpacking Instructions.....	3
Important Safeguards.....	4
Features and Benefits .....	6
Assembly Instructions, Diagram .....	8
Machine Controls .....	9
Work Bowls .....	9
Machine Functions.....	9
User Guide and Capacity Chart.....	11
Cleaning and Storage.....	15
For Your Safety.....	15
Technical Data .....	15
Troubleshooting.....	16
Warranty Information.....	17

## INTRODUCTION

The food processor that re-invented the art of food preparation once again leads the way in innovation! Congratulations on your purchase of the Cuisinart Elite Collection™ 14-Cup Food Processor – the next generation in culinary excellence.

Superbly designed for high performance and ease of use, the Cuisinart Elite Collection™ 14-Cup has the power, capacity, versatility, precision, and accessories to handle any task. From the three nested and sealed bowls to the adjustable slicing disc and reversible shredding disc, these incredible features create multiple food processors in one!

All of these pioneering, creative elements come together with Cuisinart's leading reputation to give you the Elite Collection™ 14-Cup Food Processor – the finest food prep appliance for today's modern kitchen.

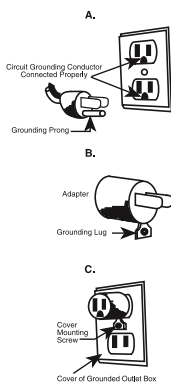

	<b>WARNING</b> RISK OF FIRE OR ELECTRIC SHOCK DO NOT OPEN	
<b>WARNING: TO REDUCE THE RISK OF FIRE OR ELECTRIC SHOCK, DO NOT REMOVE COVER (OR BACK) NO USER-SERVICEABLE PARTS INSIDE</b>		
<b>REPAIR SHOULD BE DONE BY AUTHORIZED SERVICE PERSONNEL ONLY</b>		

---

# FEATURES AND BENEFITS

## 1. Housing Base and Motor

With a vertically projecting motor shaft, this powerful base will process through a variety of recipes with a 1000 watt peak power induction motor.

## 2. Touchpad Control Panel

These easy to clean, electronically controlled buttons, feature On, Off, Dough and Pulse options, for every food processing function. The contemporary, blue LED lights will indicate when the unit is powered on.

## 3. Work Bowls

Designed with maximum versatility, the work bowl should be selected based on task appropriateness.

These nested bowls feature SealTight™ technology, which maximizes each bowl's processing capacity, ensures safe handling, and keeps all the ingredients contained in the bowl you're using! The bowls also include a locking feature to prevent them from coming out of position when pouring, and finger recesses (a) for user-friendliness.

The large, medium and small work bowls are all made of durable polycarbonate material with convenient measurement markings (b) and pour spouts (c).

## 4. Work Bowl Cover with Feed Tube

Work bowl cover with SealTight™ Advantage feature allows for maximum bowl capacity during processing and pouring. To remove the work bowl cover, push in the release buttons (a) on either side of the handle interlock (b).

The Supreme® Wide-Mouth feed tube (c) accommodates larger ingredients and saves precutting time.

## 5. Pusher Assembly

Secured with a snap-fit, the small pusher (a) inside the large pusher (b) allows you to accommodate ingredients of all sizes. The large pusher lock (c), located on the handle, enables it to be pulled out to lock and pushed in to unlock – this feature should be used when processing heavy loads.

## 6. Small Chopping/Mixing Blade

This small stainless steel blade will chop or mix anything in your small work bowl and also features the BladeLock System.

## 7. Large Chopping/Mixing Blade

Stainless steel in construction, this heavy-duty blade will process a variety of food in your large or medium work bowl. The BladeLock System enables the blade to stay in place to prevent leaking, while providing optimal pouring.

## 8. Dough Blade

Designed for our exclusive dough speed control, this blade will knead through all types of dough. The dough blade can be used only in the large bowl.

## 9. Adjustable Slicing Disc

The versatile 6-in-1 disc allows for thin to thick slices with 1 to 6 mm indicators. This disc may be used with the large or medium bowl.

## 10. Reversible Shredding Disc

Provides the option of either fine or medium shredding for optimal results. This disc may be used with the large or medium bowl.

## 11. Stem Adapter

This user-friendly tool easily attaches to either disc or small chopping/mixing blade to engage the motor shaft.

## 12. Spatula

Uniquely designed for use with any work bowl.

## 13. Retractable Cord (not shown)

The retractable cord system allows you to pull as much cord as needed, and then store it back in the housing when not in use.

**Note:** The end of the cord is wrapped with red tape to prevent over-pulling.

## 14. Accessory Storage Case

This convenient storage case with safety lock holds all of the blades and discs that are included with your new food processor.



# ASSEMBLY INSTRUCTIONS

## Before first use

Before using your Cuisinart Elite Collection™ 14-Cup Food Processor for the first time, wash all of the work bowls, work bowl cover, pusher assembly, blades, discs, and spatula (see Cleaning Instructions on page 15).

1. Place the food processor base on a dry, level countertop with the controls facing toward you. Do not plug the unit in until it is fully assembled.

**Note: To use the medium bowl, it must be nested into the large bowl. The small bowl must be nested in the medium, with the medium in the large for operation.**

2. With the large bowl on the base, use the handle to turn the work bowl counterclockwise to lock it onto the housing base.

To use the medium bowl, place your thumbs in the finger recesses and align in the large bowl with the pour spout facing the back of the unit. Push down to lock.

To use the small bowl, place your thumbs in the finger recesses and align the medium bowl with the pour spout facing opposite the handle. Push down to lock.

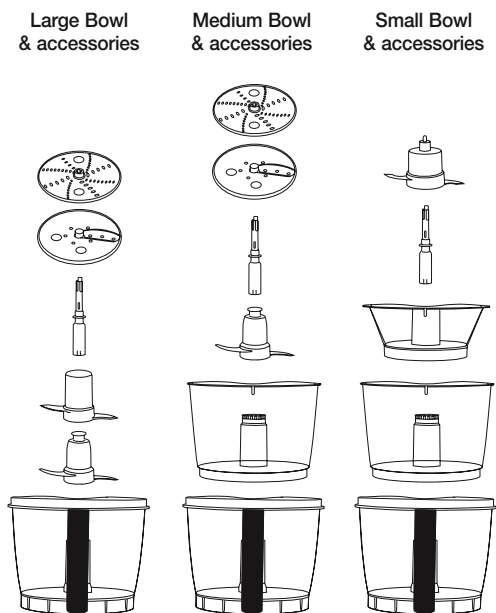

## Blade Operation

The BladeLock feature is designed to keep the blade in place during processing, pouring, lifting, and handling tasks – but is not permanently attached. **Handle with care. Always check to be sure the blade is securely locked before turning the bowl upside down.**

**Note: The chopping/mixing blades should not be removed with liquid contents above the hub of the blade in the bowls, as this will defeat the SealTight™ system.**

## Large Blade Operation

3. With your medium and/or large work bowl assembled on the base, grasp the large chopping/mixing blade by its hub, align it over the center of the bowl, place it onto the shaft and turn it until it slides into place. Firmly push down to lock. **Always check to be sure the blade is securely locked before turning the bowl upside down.** (To remove, first take the bowl off the base and put it on a flat surface. Rest the heel of your hand on the rim of the bowl and pull up gently and carefully.)

## Dough Blade Operation

4. For use with the large bowl. Carefully lift and place the dough blade on the shaft and turn it until it slides into place.

## Small Blade Operation

5. With all three work bowls assembled on the base, position the stem adapter over the center of the bowls, place it on the shaft and turn it until it slides into place. Grasp the small chopping/mixing blade by its hub, place it on the stem adapter, turning it until it slides into place, and push down firmly to lock. **Always check to be sure the blade is securely locked before turning the bowl upside down.** (To remove, first take the bowl off the base and put it on a flat surface. Rest the heel of your hand on the rim of the bowl and pull up gently and carefully.)

## Disc Operation

6. When using your medium and/or large bowl only, position the stem adapter over the center of the bowl, place it on the shaft and turn it until it slides into place. If using the adjustable slicing disc, use the rotating hub and indicator markings to select slicing thickness. Using the finger holes, align and insert the disc over the stem adapter.



If using the reversible shredding disc, determine whether the fine or medium side will be used and use the plastic hub to twist into position on the stem adapter. The finger holes may be used for removal of this disc.

### Cover Operation

7. Place the work bowl cover onto the work bowl by positioning it directly over the bowls, and push down on the front and back to lock into place.

Another way to put the cover on is by latching the back on first and then pushing down on the front to lock into place. Be sure both front and back locks are fully engaged.

To remove the cover, push in both sides of the release button (located on the cover interlock) and lift up to remove.

**Note: The work bowl cover fits, locks and seals on the large bowl with any nested bowl combination. The work bowl cover will become easier to engage with repeated use.**

8. Align pusher assembly and activating rod with the feed tube opening on the work bowl cover and slide it down completely.
9. Plug the food processor into a proper electrical outlet. It is now ready for use.

**Note: The bowl, lid and pushers must be securely in place for the unit to operate.**

Press down here

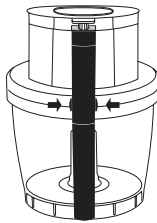
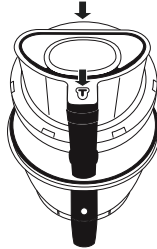

### PULSE Button

The Pulse control is a momentary button that allows the machine to run only while it is being pressed. This capability provides more accurate control of the duration and frequency of processing. Unless otherwise specified, a pulse is about one second.

1. With the machine properly assembled and engaged, and ingredients in the work bowl, press the Pulse button repeatedly as needed. The blue LED On light will be illuminated upon activation.

### DOUGH Button

1. Prepare the dough ingredients and place in work bowl fitted with the dough blade.
2. Assemble and engage the work bowl cover and pusher.
3. Press the Dough button and the blue LED light will illuminate.
4. Then press the On button to knead the dough. The blue LED On light will also be illuminated.
5. Press the Off button when finished.

**Note: Kneading dough should only be done in the large work bowl.**

## WORK BOWLS

Three nested work bowls are provided for a very versatile processing experience. We recommend using the work bowls in a manner that will optimize efficiency. For example, if your recipe requires using multiple bowls, begin with the smallest bowl to minimize cleaning. This way the small bowl can serve as a prep bowl to reserve chopped ingredients for a recipe. A great example of this would be the Cherry Crumb Muffins recipe on page 18.

Note that the bowls lock into place to pour while nested. The convenient finger recesses can be used to remove the small and medium bowls with ingredients, or the bowls can remain nested during pouring or food removal.

Chopping certain foods may scratch or cloud the work bowl, this will not affect the functionality of your work bowl.

## MACHINE FUNCTIONS

### Chopping (using the Chopping Blade)

- For raw ingredients: peel, core and/or remove seeds and pits. Food should be cut into even,

## MACHINE CONTROLS

### On Button

The On control is a continuous button that allows the machine to run until Off is selected.

1. Properly assemble and engage the machine.
2. Add ingredients to the work bowl, either through the feed tube or directly into the bowl.
3. Press the On button. The blue LED light will illuminate and the motor will start.
4. Press the Off button when finished.

---

½ to 1-inch pieces. Foods cut into same size pieces produce the most even results.

- Pulse food in 1-second increments to chop. For the finest chop, either hold the pulse down or press ON to run the machine continuously. Watch ingredients closely to achieve desired consistency and scrape the work bowl as necessary.

### **Puréeing (using the Chopping Blade)**

- To purée fresh fruits or cooked fruits/vegetables: ingredients should be cut into 1-inch pieces; a smooth purée is achieved easiest when all the pieces are equal in size. Pulse to initially chop and then process ON until food is puréed; scrape the work bowl as necessary. Do not use this method to purée cooked white potatoes. (see Mashed Potato recipe on page 50.)
- To purée solids for a soup or sauce: strain the solids from the liquid and process the solids alone. Add cooking liquid and process as needed.

### **Kneading (using the Dough Blade or the Metal Chopping Blade with Dough Speed)**

- The exclusive dough control processes pastry doughs, batters and kneads yeast bread doughs. The reduced RPMs of the dough control will achieve better results. The metal chopping blade is ideal for pastry doughs while the dough blade is specifically designed for kneading yeast doughs.
- The pusher lock is recommended to be in the locked position when kneading dough to avoid it from moving around – some vibration is still normal.
- Dough kneading should be done in the large bowl only.

### **Slicing (using the Adjustable Slicing Disc)**

- Always pack food in the feed tube evenly to slice. For smaller amounts of food, use the smaller feed tube. For cheese slicing, always use the large feed tube. The food will dictate the amount of pressure: Use light pressure for soft foods, medium pressure for medium foods, and firm pressure for harder foods. Always process with even pressure.
- For julienne or matchstick cuts: Place food horizontally in the feed tube and process with

even pressure to create long, plank-like slices. Replace stack of slices in feed tube vertically and process again using even pressure.

- For round fruits or vegetables: Remove a thick slice on the bottom of the food so that it sits upright in the feed tube. If food does not fit in the feed tube, cut in half or quarters to fit. Process with even pressure.
- For small ingredients, like mushrooms, radishes or strawberries: Trim the ends so the food sits upright in the feed tube. Take advantage of the smaller feed tube if appropriate.
- When slicing cheese, be sure that the cheese is well chilled before slicing.

### **Shredding (using the Reversible Shredding Disc)**

- Always pack food in the feed tube evenly to shred. For smaller amounts of food, use the smaller feed tube. For cheese shredding, always use the large feed tube. The food will dictate the amount of pressure: Use light pressure for soft foods, medium pressure for medium foods and firm pressure for harder foods. Always process with even pressure.
- To shred leafy vegetables like lettuce or spinach: Roll leaves together and stand up in feed tube. Process with even pressure.
- When shredding cheese, be sure that the cheese is well chilled before shredding.

---

# ACCESSORY STORAGE CASE

## Operating The Lock

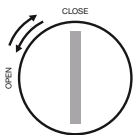

To unlock turn counter-clockwise. Gently lift up the transparent cover. Do not force the cover open when the knob is in the locked position. To lock, gently close the cover and turn the knob clockwise.

## Inserting Accessories

The Accessory Storage Case cover houses the (A) large metal blade in the right cavity, the (B) dough blade in the back cavity, and the (C) small metal blade in the left cavity. Hold each piece carefully by the center hub. **WARNING: DO NOT TOUCH METAL BLADES, AS DOING SO MAY RESULT IN INJURY.** The (D) stem adapter fits in the long center opening. Insert the stem adapter with the thinner, plastic end towards the back.

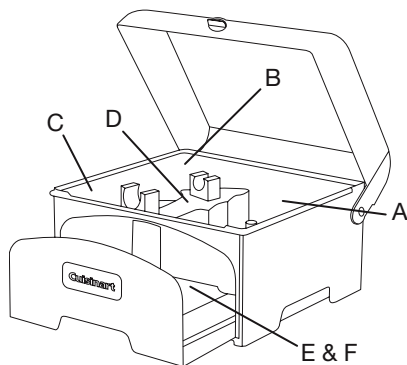

Icons embossed on the inside surface of the Accessory Storage Case show proper placement of the blades.

The discs are housed in the drawer at the lower end of the Accessory Storage Case. The (E) reversible shredding disc gets inserted first (on either side). Then the (F) adjustable slicing disc rests over the shredding disc with the plastic hub facing up. The words “shredding” and “slicing” are printed in the drawer as a reminder of the correct disc positions.

Carefully hold discs by center hub for inserting and removing from the storage case.

**WARNING: CUTTING EDGES OF FOOD PROCESSOR DISCS ARE VERY SHARP. ALWAYS KEEP FINGERS AWAY FROM SHARP SIDE.**

# USER GUIDE & CAPACITY CHART

FOOD	TOOL	PROCESS	YIELD	DIRECTIONS
<b>FRUITS</b> Apples	Metal Blade	Chop	1 pound = 3 cups	Cut into 1-inch pieces; pulse to chop – process for fine chop.
	Metal Blade	Purée	1 pound = 3 cups	Process to purée cooked and peeled apples for applesauce.
	Slicing Disc Shredding Disc	Slice Shred	1 apple = ¾ cup 1 apple = ¾ cup	Medium pressure Medium pressure
Avocados	Metal Blade	Chop	1 medium = 1 cup	Cut into 1-inch pieces; pulse to chop.
	Metal Blade	Purée	1 medium = 1 cup	Cut into 1-inch pieces; process to purée.
Bananas	Metal Blade Slicing Disc	Purée Slice	3 medium = 1 cup 1 pound = 2 cups	Process to purée ripe bananas. Light pressure for firm bananas.
Berries	Metal Blade	Purée	1 pint fresh = 2 cups; 10 ounce-bag frozen = 1½ cups	Process until puréed. Strain to remove seeds. Thaw frozen berries before processing.
	Slicing Disc	Slice	1 pint = 2 cups	Strawberries: remove stems; stack berries on their side. Medium pressure.
Coconuts	Metal Blade	Chop	1 medium = 4 cups	Cut flesh into 1-inch pieces; pulse to chop. Process to finely chop.
	Shredding Disc	Shred	1 medium = 4 cups	Cut flesh to fit feed tube, medium pressure.
Kiwis	Slicing Disc	Slice	2 kiwis = ¾ cup	Chill and peel; light pressure.
Mangoes	Metal Blade	Chop	1 medium = ¾ to 1 cup	Cut into 1-inch pieces; pulse to chop.
	Metal Blade	Purée	1 medium = ¾ to 1 cup	Cut into 1-inch pieces; process to purée.
Peaches/ Nectarines	Metal Blade	Chop	1 lb = 2 to 2½ cups	Cut into 1-inch pieces; pulse to chop.
	Metal Blade	Purée	1 lb = 2 to 2½ cups	Cut into 1-inch pieces; peel and process to purée.
	Slicing Disc	Slice	1 lb = 2 to 2½ cups	Remove pit, light pressure.
Citrus Fruits; Lemons, Limes & Oranges	Metal Blade	Chop	For medium fruit: 1 lemon = 2 to 3 teaspoons zest; 1 lime = 1 tsp zest;	Zest: use vegetable peeler to remove rind; process. For the finest chopped zest, add small amount of sugar to chop with zest
	Slicing Disc	Slice	1 orange = 1½ tablespoons zest	Trim ends; place upright in feed tube. Medium pressure.
Dried (sticky) Fruits	Metal Blade	Chop	1 pound = 2½ cups	Chill fruit. Add some flour from recipe to work bowl. Process using short pulses until desired consistency.
<b>VEGETABLES</b> Beans - Green, Wax	Metal Blade	Purée	1 cup = ½ cup purée	Process to purée cooked beans.
	Slicing Disc	Slice	1 pound = 3 cups	“French-cut”: trim beans; stack in feed tube horizontally. Light pressure.
Broccoli/ Cauliflower	Metal Blade	Chop	1 pound raw = 2 cups	Cut into 1-inch pieces; pulse to chop.
	Metal Blade	Purée	1 pound cooked = 1 cup	Cut into 1-inch pieces; process to purée.
	Slicing Disc	Slice	Broccoli stems only	Peel and trim stems. Medium pressure.
	Shredding Disc	Shred	Broccoli stems only	Peel and trim stems. Medium pressure.
Cabbage	Metal Blade	Chop	2 pounds = 8 cups	Cut into 1-inch pieces; pulse to chop to desired consistency.
	Slicing Disc	Slice	2 pounds = 8 cups	Cut in wedges to fit feed tube; remove center core. Light to no pressure. Use slicing disc for coleslaw.
	Shredding Disc	Shred	2 pounds = 8 cups	Use shredding disc for extra-fine needs.
Carrots	Metal Blade	Chop	1 pound (6 med) = 3 cups	Cut into 1-inch pieces; pulse to chop to desired consistency.
	Metal Blade	Purée	2 med cooked = ½ cup purée	Process to purée.
	Slicing Disc	Slice	1 pound (6 med) = 3 cups	Small rounds: trim; place upright in feed tube. Long slices: trim; place horizontally in feed tube. Medium to firm pressure.
	Shredding Disc	Shred	1 pound (6 med) = 2½ cups	Small shreds: trim; place upright in feed tube. Long shreds: trim; place horizontally in feed tube. Medium to firm pressure.

FOOD	TOOL	PROCESS	YIELD	DIRECTIONS
Celery	Metal Blade	Chop	2 medium stalks = ½ cup	Cut into 1 inch pieces; pulse to chop to desired consistency.
	Slicing Disc	Slice	2 medium stalks = ½ cup	Trim; place upright in feed tube. Medium pressure.
Cucumbers	Metal Blade	Chop	1 medium = 1½ cups	Cut into 1-inch pieces; pulse to chop.
	Slicing Disc	Slice	1 medium = 1½ cups	Rounds: trim; place upright in feed tube. Medium pressure. Long slices: trim; place horizontally in feed tube. Medium pressure.
	Shredding Disc	Shred	1 medium = 1½ cups	Shreds: trim; place upright in feed tube. Medium pressure. Long shreds: trim; place horizontally in feed tube. Medium pressure.
Garlic	Metal Blade	Chop	1 head = 12 to 16 cloves; 1 medium clove = ½ teaspoon	Peel; with machine running, drop cloves through feed tube to finely chop.
Ginger	Metal Blade	Chop	1-inch pieces = 1 tablespoon	Peel; cut into ½-inch pieces. With machine running, drop through feed tube to finely chop.
	Slicing Disc	Slice	4 ounces = ½ cup	Peel; place upright in feed tube. Medium pressure.
	Shredding Disc	Shred	4 ounces = ½ cup	Peel; place upright in feed tube. Medium pressure.
Herbs - Fresh	Metal Blade	Chop	1 cup loosely packed = ½ cup	Herbs, work bowl and blade should be clean and completely dry. Pulse to roughly chop. Process to finely chop. Keep up to 10 days in airtight bag in refrigerator.
Jalapeño	Metal Blade	Chop	1 medium pepper = 3 tablespoons	Remove seeds and stem. With machine running, drop halved pepper through feed tube to chop.
	Slicing Disc	Shred	1 medium pepper = ¼ cup	Remove seeds and stem. Cut stem end flat to slice into rings; medium pressure. Place upright in feed tube for narrow slices, horizontally for longer slices.
Leeks	Metal Blade	Chop	1 pound = 2 cups	Clean leeks; trim, discard dark green parts. Cut into 1-inch pieces; pulse to chop.
	Slicing Disc	Slice	1 pound = 2 cups	Clean leeks as above. Place upright in feed tube; medium pressure. Long slices: trim; place lengthwise in feed tube. Medium pressure.
Mushrooms	Metal Blade	Chop	1 pound = 6 cups	Cut into even pieces; pulse to chop.
	Slicing Disc	Slice	1 pound = 5 cups	Pack feed tube. Light pressure.
	Shredding Disc	Shred	1 pound = 5 cups	Pack feed tube. Light pressure.
Onions	Metal Blade	Chop	1 pound = 4½ to 5 cups	Cut into 1-inch pieces; pulse to chop.
	Slicing Disc	Slice	1 medium = ¾ to 1 cup	Trim; place in feed tube. Medium pressure.
Peppers - Bell	Metal Blade	Chop	1 pound = 4½ to 5 cups	Cut into 1-inch pieces; pulse to chop.
	Slicing Disc	Slice	1 pound = 3 cups	Remove seeds and stem. Cut stem end flat to slice into rings; medium pressure. Halve or quarter and place upright in feed tube for narrow slices, horizontally for longer slices.
Pickles	Metal Blade	Chop	1 medium = ¾ cup	Cut into 1-inch pieces; pulse to chop.
	Slicing Disc	Slice	1 medium = ¾ cup	Place upright in feed tube for rounds; horizontally for longer slices. Medium pressure.
Potatoes	Metal Blade	Chop	1 pound = 3½ to 4 cups	Raw potatoes: cut into 1-inch pieces; pulse to chop.
	Metal Blade	Purée	1 cup cooked (1-inch pieces) = ½ cup	Sweet potatoes/yams: cut into 1-inch pieces; pulse to chop.
	Slicing Disc	Slice	1 pound = 3½ to 4 cups	Trim end flat; cut to fit into feed tube. Light to medium pressure for white potatoes; firm pressure for sweet potatoes/yams; light pressure for partially cooked potatoes.
	Shredding Disc	Shred	1 pound = 3½ to 4 cups	Trim end flat; cut to fit into feed tube. Light to medium pressure for white potatoes. Note: keep sliced or shredded raw potatoes in cold water to avoid discoloration; dry well before using. Mashed potatoes: process cooked white potatoes through medium shredding disc to avoid a gluey consistency.

FOOD	TOOL	PROCESS	YIELD	DIRECTIONS
Radishes	Metal Blade	Chop	½ pound = 1½ cups	Cut into 1-inch pieces; pulse to chop. Process to finely chop. Trim ends; firm pressure. Trim ends; firm pressure.
	Slicing Disc	Slice	½ pound = 1½ cups	
	Shredding Disc	Shred	½ pound = 1½ cups	
Scallions	Metal Blade	Chop	1 to 2 = ¼ cup	Cut into 1-inch pieces; pulse to chop. Trim, discard dark green parts, place upright in feed tube. Light to medium pressure. Long slices: trim; place lengthwise in feed tube. Medium pressure.
	Slicing Disc	Slice	1 to 2 = ¼ cup	
Spinach	Metal Blade	Chop	1 pound raw = 10 cups raw	Pulse to chop. Process to purée.
	Metal Blade	Purée	1 pound raw = 1½ cups cooked	
	Slicing Disc	Slice	1 pound raw = 10 cups raw	Roll leaves together and place upright in feed tube; medium pressure.
Zucchini/Summer Squash	Metal Blade	Chop	1 pound = 3 cups	Cut into 1-inch pieces; pulse to chop. Rounds: trim; place upright in feed tube. Long slices: trim; place horizontally in feed tube. Medium pressure. Shredding: trim; place upright in feed tube. Long shreds: trim and place horizontally in feed tube. Medium pressure.
	Slicing Disc	Slice	1 pound = 3 cups	
	Shredding Disc	Shred	1 pound = 3 cups	
<b>CHEESES</b> Soft Cheeses; Ricotta, Cream, Cottage, Brie, Blue, Fontina Mozzarella, Bel Paese	Metal Blade	Purée	½ pound = 1 cup	Cut into 1-inch pieces. Process soft cheeses until smooth. Cut into 1-inch pieces; pulse to chop.
	Metal Blade	Chop	¼ pound = 1 cup	
	Shredding Disc Shredding Disc	Med. Shred	¼ pound = 1 cup	Chill well; medium pressure. Mozzarella should be frozen for 25 to 30 minutes before shredding.
		Fine Shred	¼ pound = 1 cup	
Firm Cheeses; Cheddar, Swiss, Edam & Gouda	Metal Blade	Chop	¼ pound = 1 cup	Cut into ½- to 1-inch pieces; temperature not critical. Chill well; light to medium pressure. Chill well; medium pressure. Chill well; light pressure.
	Slicing Disc	Slice	¼ pound = 1 cup	
	Shredding Disc	Med. Shred	¼ pound = 1 cup	
	Shredding Disc	Fine Shred	¼ pound = 1 cup	
Hard Cheeses; Parmesan & Romano	Metal Blade	Chop	¾ pound = 3 cup	Cut into ½- to 1 inch pieces; temperature not critical. *Never process cheese that cannot be pierced with the tip of a sharp knife. Cheese should be room temperature. Cheese should be room temperature.
	Shredding Disc Shredding Disc	Med. Shred	¼ pound = 1 cup	
		Fine Shred	¼ pound = 1 cup	
<b>ADDITIONAL FOODS</b> Baby Food	Metal Blade	Purée		As with all fruit and cooked vegetable purées, cut ingredients into 1-inch pieces. Steam cooked ingredients until completely soft. Pulse to chop, then process until completely smooth. To ensure there are no lumps, press mixture through a fine mesh strainer. Keeps well frozen in ice cube trays for individual 1-ounce portions.
Butter	Metal Blade	Chop	¼ pound (1 stick) = ½ cup	Butter should be room temperature and cut into tablespoon-size pieces. Process, scraping bowl as necessary. Compound butters: process flavoring ingredients before adding butter. Pastry: cut butter into small cubes; freeze before using. Butter should be cold, not frozen; medium pressure.
	Slicing Disc	Slice	¼ pound (1 stick) = ½ cup	
Chocolate	Metal Blade	Chop	1-ounce = ¼ cup grated	Cut into ½- to 1-inch pieces (or use chocolate chips). Pulse to start, then process to desired consistency. Texture will appear more rounded than grated. Chill chocolate; medium to firm pressure.
	Shredding Disc	Shred	1-ounce = ¼ cup grated	
Crumbs; Bread, Cookies & Crackers	Metal Blade	Chop	12 to 14 graham wafers = 1 cup crumbs; 1 slice bread = ½ cup crumbs	Break up ingredients into ½- to 1-inch pieces. Process until fine. Breadcrumbs: make from fresh, stale or toasted bread.

FOOD	TOOL	PROCESS	YIELD	DIRECTIONS
Egg Whites	Metal Blade	Chop	8 egg whites = 1 cup firm whites	Egg whites should be room temperature; add 1 teaspoon lemon juice or vinegar per white. Process in an absolutely clean bowl for 1 to 2½ minutes until surface develops ridges and mass of whites almost stops moving. These egg whites should not be used in meringues. For whipped egg whites with volume, whip with whisk or electric mixer.
Meat, Poultry & Fish	Metal Blade	Chop	2¼ pound boneless = 4½ cups	Cut <i>very</i> cold raw or cooked meat/poultry/fish into 1-inch pieces; pulse to chop. Process for a few seconds at a time for a finer chop. Check texture often to avoid overprocessing.
	Metal Blade	Purée	1 pound boneless = 2 cups	Cut <i>very</i> cold raw or cooked meat/poultry/fish into 1-inch pieces; pulse to chop. Process continuously until desired texture.
	Slicing Disc	Slice	1 pound boneless = 2 cups	Slicing cooked meat/poultry: be sure it is <i>very</i> cold. Use a single chunk of meat at a time. Slicing raw meat/poultry: cut to fit feed tube; wrap in plastic to briefly freeze. Raw meat is ready to slice when hard to the touch but can easily be pierced with tip of a sharp knife. *Slicing meats works best when semi-frozen.
Milk Shakes/Smoothies	Metal Blade	Chop/ Purée	Can make up to 16 8-ounce servings.	Milkshakes: add ice cream first; process and add milk through feed tube. Smoothies: add fruit first, then add the liquid while processing.
Nuts	Metal Blade	Chop	¾ pound = 3 cups	Pulse to chop. Hardness of nut dictates amount and time of processing. If either flour or sugar is added to nuts during processing, they can be processed as long as possible without becoming butter. Coarsely chopped nuts: 6 to 8 pulses. Finely chopped nuts: pulse 2 to 3 times, then process 20 to 30 seconds, watching carefully for desired consistency.
	Metal Blade	Purée	¼ pound = 1 cup	Nut butter: process nuts 2 to 3 minutes, scraping bowl as necessary. For smoothest consistency, add some oil to nuts while processing.
	Slicing Disc	Slice	¼ pound = 1 cup	Medium pressure; nuts will have a coarse texture.
	Shredding Disc	Shred (fine/med.)	¼ pound = 1 cup	Medium pressure; nuts will have a fine/medium texture.
Granulated Sugar (to make extra super-fine sugar)	Metal Blade	Chop	1 pound = 2 cups	Process 1 minute, or until fine.
Tofu	Metal Blade	Purée	10 ounces = ¾ cup	Drain; process 2 minutes or until smooth.
Whipping Cream	Metal Blade	Chop	1 cup = ½ cup whipped	Process well-chilled cream until cream begins to thicken. Add sugar as desired; process continuously until cream reaches desired consistency (about 3 to 4 minutes).
<b>DOUGHS</b> Pastry Dough	Metal Blade	Mix		Pulse mixture until it has consistency between cornmeal and small pebbly crumbs. Add water, 1 tablespoon at a time; pulse until a dough forms.
<b>Batters</b> Quick Bread, Cake & Cookies	Metal Blade	Mix		First sift dry ingredients together by processing; remove and reserve. Process the fats and sugars together and then add any remaining liquid ingredients. Pulse in reserved dry ingredients. Any ingredients that need to be coarsely chopped can be added with dry ingredients. For finely chopped ingredients, chop separately in small work bowl and then add to batter at the end.
<b>Yeast Dough</b> Breads	Metal Blade Dough Blade	Mix Knead		<b>TIPS:</b> Use ¾ cup warm liquid to proof 2¼ teaspoons dry active yeast. Sugar/honey aids in activating yeast, so add a small amount, about 1 teaspoon, to the warm liquid/yeast mixture when proofing. Food processor can handle up to 8 cups white flour for a yeast bread dough. The dough should have a soft, pliable texture and feel only slightly tacky.*
<b>Sweet Dough</b> Breads & Coffee Cakes	Metal Blade Dough Blade	Mix Knead		See <b>TIPS</b> above, but keep in mind that sweet doughs will be rich and sticky and may not clean sides of bowl; bowl may need to be scraped. Sweet doughs require less kneading once the ingredients are mixed.*

**Note:** Use dough blade for kneading dough in the large bowl only. The medium or small bowls may not be used for dough.

\*See troubleshooting for additional direction and techniques.

---

## CLEANING AND STORAGE

Keep your Cuisinart Elite Collection™ 14-Cup Food Processor ready to use on the kitchen counter. When not in use, leave it unplugged.

This food processor includes a storage case with lock for safekeeping of blades and discs. Keep the blades and discs out of the reach of children.

All parts except the housing base are dishwasher safe, and we recommend washing them in the dishwasher on the **top rack only**. Due to intense water heat, washing the work bowl, cover and accessories on the bottom rack may cause damage over time. Insert the cover with the feed tube facing up to ensure proper cleaning of the seal. (Note: The seal is not removable and water will drain properly.) Insert the work bowl and pushers upside down for drainage. Remember to unload the dishwasher carefully wherever you place sharp blades and discs.

To simplify cleaning, rinse the work bowl, cover, pusher assembly and blade or disc immediately after use so food won't dry on them. Be sure to place the pushers upside down for drainage. If food lodges in the pusher, remove it by running water through it, or use a bottle brush.

If you wash blades and discs by hand, do it carefully. When handling, use the plastic hubs on the blades and finger holes for the discs. Avoid leaving them in soapy water where they may disappear from sight. To clean the metal blade, fill the work bowl with soapy water, hold the blade by its plastic center and move it rapidly up and down on the center shaft of the bowl. Use of a spray attachment is also effective. If necessary, use a brush.

The work bowl is made of polycarbonate plastic, which is shatter resistant and heat resistant. It should not be placed in a microwave oven, as the aperture at the front of the pusher houses the metal rod that activates the motor.

The housing base may be wiped clean with a soapy, non-abrasive material. Be sure to dry once clean.

Four rubber feet on the underside keep the base from moving on most work surfaces when the machine is processing heavy loads. If the feet leave spots on the counter, spray them with a spot remover and wipe with a damp sponge. If any trace of the spot remains, repeat the procedure and wipe the area with a damp sponge and nonabrasive cleaning powder.

The Accessory Storage Case is made of a high-impact plastic that has a smooth, easy-to-clean

surface. Occasionally wipe your Accessory Storage Case with a cloth or sponge that has been dipped in warm soapy water. To remove stubborn spots, use a mild soap solution, then wipe with a damp sponge. **Do not put the Accessory Storage Case in the dishwasher.** Blades, stem adapter and discs should always be clean when they are put into the Accessory Storage Case. The Accessory Storage Case is not meant for temporary storage of soiled blades between periods of use.

**IMPORTANT:** Never store any blade or disc on the motor shaft. No blade or disc should be placed on the shaft except when the processor is about to be used.

## FOR YOUR SAFETY

Like all powerful electrical appliances, a food processor should be handled with care. Follow these guidelines to protect yourself and your family from misuse that could cause injury.

Handle and store metal blades and discs carefully. Their cutting edges are very sharp.

Always place the stem adapter on the motor shaft before assembling the discs.

Never put blades or discs on the motor shaft until the work bowl is locked in place.

Always be sure that the blade or disc is down on motor shaft as far as it will go.

Always insert chopping blade and dough blade in the work bowl before putting ingredients in bowl.

When slicing or shredding food, always use the pusher. Never put your fingers or spatula into feed tube.

Always wait for the blade or disc to stop spinning before you remove the pusher assembly or cover from the work bowl.

Always unplug the unit before removing food, cleaning, or putting on or taking off parts.

Always remove work bowl from base of machine before you remove chopping blade or dough blade.

## TECHNICAL DATA

The motor in your food processor operates on a standard line operating current. The appropriate voltage and frequency for your machine are shown on a label on the bottom of the base.

An automatic, temperature-controlled circuit breaker in the motor ensures complete protection against motor burnout. If the processor runs for an exceptionally long time



---

when chopping, mixing or kneading a thick or heavy mixture in successive batches, the motor may overheat. If this happens, the processor will stop. Turn it off and wait for the motor to cool before proceeding. It will usually cool within 10 minutes. In extreme cases, it could take an hour.

Safety switches prevent the machine from operating when the work bowl or the cover is not locked into position. The motor stops within seconds when the motor is turned off, and when the pusher assembly is removed, a fast-stop circuit also enables the motor to stop within seconds.

Cuisinart offers a Limited Three-Year Warranty on the entire machine.

## TROUBLESHOOTING

### Food Processing

1. **Problem:** The food is unevenly processed

**Solution:**

- The ingredients should be cut evenly into ½- to 1-inch pieces before processing.
- Process in batches to avoid overloading.

2. **Problem:** Slices are uneven or slanted

**Solution:**

- Place evenly cut food into the feed tube.
- Apply even pressure on the pusher.

3. **Problem:** Food falls over in feed tube

**Solution:**

- Large feed tube must be packed full for best results. If processing smaller quantities, use the small feed tube.

4. **Problem:** Some food remains on top of the disc.

**Solution:**

- It is normal for small pieces to remain; cut remaining bits by hand and add to processed ingredients.

### Dough Processing

1. **Problem:** The dough control button does not work.

**Solution:**

- The dough control works in conjunction with the ON button. The food processor will only operate once the ON is selected after the dough function is activated.

2. **Problem:** Motor slows down.

**Solution:**

- Amount of dough may exceed maximum capacity of your food processor. Remove half and process in two batches.
- Dough may be too wet (see number 10). If motor speeds up, continue processing. If not, add more flour, 1 tablespoon at a time until the motor speeds up. Process until dough cleans the side of the work bowl.

3. **Problem:** Blade doesn't incorporate ingredients.

**Solution:**

- Always start the food processor before adding liquid. Add liquid in a slow, steady stream, allowing the dry ingredients to absorb it. If too much liquid is added, wait until ingredients in the work bowl have mixed, then add remaining liquid slowly (do not turn off the machine). Pour liquid onto dough as it passes under feed tube opening; do not pour liquid directly onto bottom of the work bowl.

4. **Problem:** Blade rises in work bowl

**Solution:**

- Excessively sticky dough can cause blade to rise. Reinsert blade and immediately add 2 tablespoons of flour through the feed tube while the machine is running.

5. **Problem:** The large pusher moves when processing dough or other heavy loads.

**Solution:**

- The pusher lock feature, located above the handle, should be pulled out (some vibration is normal).

6. **Problem:** Dough doesn't clean inside of the work bowl.

**Solution:**

- Amount of dough may exceed maximum capacity of your food processor. Remove half and process in two batches.

- Dough may be too dry (see number 9).
- Dough may be too wet (see number 10).

7. **Problem:** Nub of dough forms on top of blade and does not become uniformly kneaded.

**Solution:**

- Stop machine, carefully remove dough, divide it into 3 pieces and redistribute them evenly in the work bowl.

---

8. **Problem:** Dough feels tough after kneading

**Solution:**

- Divide dough into 2 or 3 pieces and redistribute evenly in bowl. Process 10 seconds or until uniformly soft and pliable.

9. **Problem:** Dough is too dry.

**Solution:**

- While machine is running, add water, 1 tablespoon at a time until dough cleans the inside of the bowl.

10. **Problem:** Dough is too wet.

**Solution:**

- While machine is running, add flour, 1 tablespoon at a time until dough cleans the inside of the bowl.

**Technical**

1. **Problem:** The motor does not start.

**Solution:**

- There is a safety interlock to prevent the motor from starting if it is not properly assembled. Make sure the work bowl and work bowl cover are securely locked into position.
- If you are slicing or shredding and the above solution does not work, make sure that the food contents in the feed tube are cut below the maximum fill line so that the activation rod can engage the motor.
- If the motor still will not start, check the power cord and outlet.

2. **Problem:** The food processor shuts off during operation.

**Solution:**

- The cover may have become unlocked; check to make sure it is securely in position.
- A safety protector in the motor prevents the motor from overheating, which is caused by excessive strain. Press the Off control button and wait 10 to 15 minutes to allow the food processor to cool off before resuming.

3. **Problem:** The food processor cover becomes unlatched in the back and or makes a loud noise.

**Solution:**

- The back of the cover becoming unlatched, and any related noise, will not prevent the unit from working. Simply push down to lock the back into position.

4. **Problem:** The motor slowed down during operation.

**Solution:**

- This is normal as some heavier loads (e.g. slicing/shredding cheese) may require the motor to work harder. Simply reposition the food in the feed tube and try again.
- The maximum load capacity may have been exceeded. Remove some of the ingredients and continue processing.

5. **Problem:** It is difficult to remove the chopping/mixing blade from the work bowl.

**Solution:**

- These innovative blades have been designed to lock in the work bowl to prevent them from falling out when emptying the contents of the bowl. Using extreme care, use a little extra force to remove the blade.

6. **Problem:** The food processor vibrated/moved around the countertop during processing.

**Solution:**

- Make sure the rubber feet at the bottom of the unit are clean and dry. Also make sure that the maximum load capacity is not being exceeded.
- This is normal as some heavier loads (e.g. slicing/shredding cheese) may require the motor to work harder.

7. **Problem:** The large pusher falls out when the cover is turned upside down.

**Solution:**

- The pusher lock feature, located above the handle, should be pulled out.

---

# **WARRANTY**

## **FULL TWENTY-YEAR MOTOR WARRANTY**

### **LIMITED 3-YEAR WARRANTY**

This warranty is available to consumers only. You are a consumer if you own a Cuisinart Elite Collection™ 14-Cup Food Processor that was purchased at retail for personal, family or household use. Except as otherwise required under applicable law, this warranty is not available to retailers or other commercial purchasers or owners.

We warrant that your Cuisinart Elite Collection™ 14-Cup Food Processor will be free of defects in materials and workmanship under normal home use for three years from the date of original purchase.

We suggest you complete and return the enclosed product registration card promptly to facilitate verification of the date of original purchase. However, return of the product registration card does not eliminate the need for the consumer to maintain the original proof of purchase in order to obtain the warranty benefits. In the event that you do not have proof of purchase date, the purchase date for purposes of this warranty will be the date of manufacture.

If your Cuisinart Elite Collection™ 14-Cup Food Processor should prove to be defective within the warranty period, we will repair it, or if we think necessary, replace it. To obtain warranty service, simply call our toll-free number 1-800-726-0190 for additional information from our Customer Service Representatives, or send the defective product to Customer Service at Cuisinart, 150 Milford Road, East Windsor, NJ 08520.

To facilitate the speed and accuracy of your return, please enclose \$10.00 for shipping and handling of the product.

Please pay by check or money order (California residents need only supply proof of purchase and should call 1-800-726-0190 for shipping instructions).

NOTE: For added protection and secure handling of any Cuisinart® product that is being returned, we recommend you use a traceable, insured delivery service. Cuisinart cannot be held responsible for in-transit damage or for packages that are not delivered to us. Lost

and/or damaged products are not covered under warranty. Please be sure to include your return address, daytime phone number, description of the product defect, product model number (located on bottom of product), original date of purchase, and any other information pertinent to the product's return.

Your Cuisinart Elite Collection™ 14-Cup Food Processor has been manufactured to the strictest specifications and has been designed for use with the authorized accessories and replacement parts.

This warranty expressly excludes any defects or damages caused by accessories, replacement parts, or repair service other than those that have been authorized by Cuisinart.

This warranty does not cover any damage caused by accident, misuse, shipment or other ordinary household use.

This warranty excludes all incidental or consequential damages. Some states do not allow the exclusion or limitation of these damages, so these exclusions may not apply to you.

#### **CALIFORNIA RESIDENTS ONLY:**

California law provides that for In-Warranty Service, California residents have the option of returning a nonconforming product (A) to the store where it was purchased or (B) to another retail store which sells Cuisinart® products of the same type.

The retail store shall then, at its discretion, either repair the product, refer the consumer to an independent repair facility, replace the product, or refund the purchase price less the amount directly attributable to the consumer's prior usage of the product. If the above options do not result in the appropriate relief to the consumer, the consumer may then take the product to an independent repair facility if service or repair can be economically accomplished. Cuisinart and not the consumer will be responsible for the reasonable cost of such service, repair, replacement, or refund for nonconforming products under warranty.

California residents may also, according to their preference, return nonconforming products directly to Cuisinart for repair, or if necessary, replacement, by calling our Consumer Service Center toll-free at 1-800-726-0190.

Cuisinart will be responsible for the cost of the repair, replacement, and shipping and handling for such products under warranty.

---

## **BEFORE RETURNING YOUR CUISINART® PRODUCT**

If you are experiencing problems with your Cuisinart® product, we suggest that you call our Cuisinart® Service Center at 1-800-726-0190 before returning the product to be serviced. If servicing is needed, a Representative can confirm whether the product is under warranty and direct you to the nearest service location.

Important: If the nonconforming product is to be serviced by someone other than Cuisinart's Authorized Service Center, please remind the servicer to call our Consumer Service Center at 1-800-726-0190 to ensure that the problem is properly diagnosed, the product is serviced with the correct parts, and the product is still under warranty.

©2009 Conair Corporation  
Cuisinart® is a registered trademark  
of the Conair Corporation

150 Milford Road  
East Windsor, NJ 08520  
Printed in China

08CE12003

**IB-8478**