

FOR CAR USE ONLY/NUR FÜR AUTOMOBIL GEBRAUCH/POUR APPLICATION AUTOMOBILE UNIQUEMENT/PARA USO EN AUTOMÓVILES/SOLO PER L'UTILIZZO IN AUTOMOBILE/ENDAST FÖR BILBRUK/ALLEEN VOOR GEBRUIK IN DE AUTO/ ТОЛЬКО ДЛЯ ИСПОЛЬЗОВАНИЯ В АВТОМОБИЛЯХ/DO UŻYCIA TYLKO W SAMOCHODZIE

# ALPINE®

## CD/USB RECEIVER WITH ADVANCED BLUETOOTH

# CDE-185BT



Alpine Tunelt App



Variable  
RGB Illumination



- OWNER'S MANUAL  
Please read before using this equipment.
- BEDIENUNGSANLEITUNG  
Lesen Sie diese Bedienungsanleitung bitte vor Gebrauch des Gerätes.
- MODE D'EMPLOI  
Veuillez lire avant d'utiliser cet appareil.
- MANUAL DE OPERACIÓN  
Léalo antes de utilizar este equipo.
- ISTRUZIONI PER L'USO  
Si prega di leggere prima di utilizzare il attrezzatura.
- ANVÄNDARHANDLEDNING  
Innan du använder utrustningen bör du läsa igenom denna användarhandledning.
- GEBRUIKERSHANDLEIDING  
Lees deze aanwijzingen aandachtig alvorens dit toestel te gebruiken.
- РУКОВОДСТВО ПО ЭКСПЛУАТАЦИИ  
Прочтите настоящее руководство перед началом использования оборудования.
- INSTRUKCJA OBSŁUGI  
Prosimy zapoznać się z tą instrukcją przed przystąpieniem do użytkowania urządzenia.

**ALPINE ELECTRONICS MARKETING, INC.**  
1-7, Yukigaya-Otsukamachi, Ota-ku,  
Tokyo 145-0067, JAPAN  
Phone: 03-5499-4531

**ALPINE ELECTRONICS OF AMERICA, INC.**  
19145 Gramercy Place, Torrance,  
California 90501, U.S.A.  
Phone 1-800-ALPINE-1 (1-800-257-4631)

**ALPINE ELECTRONICS OF AUSTRALIA PTY. LTD.**  
161-165 Princes Highway, Hallam  
Victoria 3803, Australia  
Phone 03-8787-1200

**ALPINE ELECTRONICS GmbH**  
Wilhelm-Wagenfeld-Str. 1-3, 80807 München, Germany  
Phone 089-32 42 640

**ALPINE ELECTRONICS OF U.K. LTD.**  
Alpine House  
Fletchamstead Highway, Coventry CV4 9TW, U.K.  
Phone 0870-33 33 763

**ALPINE ELECTRONICS FRANCE S.A.R.L.**  
(RCS PONTOISE B 338 101 280)  
98, Rue de la Belle Etoile, Z.I. Paris Nord II,  
B.P. 50016, 95945 Roissy Charles de Gaulle  
Cedex, France  
Phone 01-48638989

**ALPINE ITALIA S.p.A.**  
Viale C. Colombo 8, 20090 Trezzano  
Sul Naviglio (MI), Italy  
Phone 02-484781

**ALPINE ELECTRONICS DE ESPAÑA, S.A.**  
Portal de Gamarra 36, Pabellón, 32  
01013 Vitoria (Alava)-APDO 133, Spain  
Phone 945-283588

EN

DE

FR

ES

IT

SE

NL

RU

PL



## Operating Instructions

### WARNING

WARNING .....	6
CAUTION .....	6
PRECAUTIONS .....	6

### Getting Started

Accessory List .....	9
Turning Power On and Off .....	9
Demonstration Function .....	9
Source Selection .....	9
Detaching and Attaching the Front Panel .....	9
Detaching .....	9
Attaching .....	10
Initial System Start-Up .....	10
Adjusting Volume .....	10
Setting Time .....	10

### Radio

Listening to Radio .....	11
Presetting Stations Manually .....	11
Presetting Stations Automatically .....	11
Tuning to Preset Stations .....	11
Frequency Search Function .....	11

### RDS

Turning AF (Alternative Frequencies) ON/OFF .....	12
Receiving RDS Regional (Local) Stations .....	12
PI SEEK Setting .....	12
Receiving Traffic Information .....	12
Receiving Traffic Information While Playing	
USB Audio or Radio .....	13
Displaying Radio Text .....	13

### CD/MP3/WMA/AAC

Playback .....	13
Repeat and Random Play .....	14
Searching for CD Text .....	14
Folder/File Name Search (concerning MP3/WMA/AAC) .....	14
Folder Name Search mode .....	14
File Name Search mode .....	14
Search Position Memory .....	14
About MP3/WMA/AAC .....	15
Terminology .....	16

## Sound Setting

Adjusting Subwoofer Level/Bass Level/ Treble Level/Balance (Between Left and Right)/ Fader (Between Front and Rear)/Defeat .....	16
Sound Setting .....	17
Equalizer Presets .....	17
Setting BASS ENGINE SQ ON/OFF .....	17
Displaying the BASS ENGINE SQ PARAMETER .....	17
Adjusting the Parametric Equalizer Curve (9BAND P-EQ) .....	17
Adjusting the Frequency (CENTER FRQ) .....	17
Setting the Bandwidth (WIDTH (Q)) .....	17
Adjusting the Level .....	18
Setting the Source Volume Level .....	18
Adjusting the High Pass Filter .....	18
Turning Subwoofer ON/OFF .....	18
Adjusting the Low Pass Filter .....	18
Setting the Subwoofer Phase .....	18
Setting the Subwoofer System .....	18
External Device .....	18
Connecting to an External Amplifier (Power IC) .....	18
Setting the Media Xpander mode .....	19
BASS ENGINE SQ Function .....	19
Switching BASS ENGINE SQ mode .....	19
Adjusting BASS ENGINE SQ Level .....	19

## Other Functions

Displaying the Text .....	20
About "Text" .....	20
Using the Front AUX Input Terminal .....	20
Option Menu Setting .....	20
Applying Tunelt .....	21
Adjusting the sound via the Smartphone ...	21
Facebook Notification Function .....	22
Receiving Notification .....	22
Displaying Notification List .....	22

## SETUP

Setting .....	22
General Setting .....	23
Setting the Clock Display (CLOCK MODE) .....	23
Setting the Time to automatically be adjusted .....	23
Setting the Menu Language .....	23
Setting the AUX SETUP mode .....	23
Setting the AUX NAME mode .....	23
Playing MP3/WMA/AAC Data (PLAY MODE) .....	23
Setting the stay on mode .....	23
Demonstration .....	23

- Display Setting ..... 24
  - Changing Lighting Colour .....24
  - Setting the Spectrum analyzer.....24
  - Dimmer Control .....24
  - Scroll Setting (TEXTSCROLL) .....24
  - Scroll Type Setting .....24
- Tuner Setting ..... 24
  - Setting the TUNER (FM) tone quality (FM SET) .....24
- iPod Setting ..... 25
  - iPod/iPhone Search Mode Setting .....25
- Application Setting (APP) ..... 25
  - Setting the communication mode with a Smartphone (ALPINE APP) .....25
  - Setting the TTS (Text To Speech) volume.....25

## BT Hands Free Calling

- Setup Before Using ..... 25
  - About BLUETOOTH ..... 25
  - Before Using BLUETOOTH Function ..... 25
  - How to connect to a BLUETOOTH compatible device (Pairing) .....26
    - For BLUETOOTH compatible device with SSP (Secure Simple Pairing) .....26
    - For BLUETOOTH compatible device without SSP (Secure Simple Pairing) .....26
    - Auto pairing with an iPod/iPhone.....26
- BLUETOOTH SETUP ..... 26
  - Setting the BLUETOOTH Connection (BT IN) ..... 26
  - Setting the Auto Pairing with iPod/iPhone ..... 27
  - Setting the BLUETOOTH Device ..... 27
  - Setting the Visible Mode ..... 27
  - Setting the BLUETOOTH sound quality..... 27
    - Adjusting the volume (SOURCE VOL) .....27
    - Sound Auto setting (TYPE SET) .....27
  - Setting the caller information display ON/OFF ..... 27
  - Setting the Phone Book Update ..... 28
    - Setting the Phone Book Auto Update ON/OFF (AUTO) .....28
    - Setting the Phone Book Manual Update ON/OFF (MANUAL).....28
  - Changing the Phone book List Order..... 28
  - Setting the Received Calls automatically (Auto Answer)..... 28
  - Selecting the output speaker ..... 28
  - Displaying the firmware version..... 28
  - Updating the firmware ..... 28

- Hands-Free Phone Control .....28
  - About the Hands-Free Phone.....28
  - Answering a Call .....29
  - Hanging up the Telephone .....29
  - Calling .....29
    - Redialling a Number In Outgoing History.....29
    - Dialling a Number In Incoming History .....29
    - Dialling a Number In Incoming Missed Call History .....29
    - Dialling a Number In The Phone Book .....29
    - Phone book Alphabet Search Function .....30
- Voice Control Operation .....30
- Call waiting function .....30
- Preset a number in the Phone Menu (Shortcut dial) .....30
- Dialling the preset number .....30
- Adjusting the volume when receiving a Call .....31
  - Muting the microphone input quickly (Voice Mute) .....31
- Call Switching Operation .....31
- BLUETOOTH Audio Operation.....31
  - Recalling the BLUETOOTH Audio Mode .....31
  - Selecting the desired Song .....31
  - Pausing.....31
  - Selecting the desired Group.....31
  - Searching for a desired song .....31

## USB Memory (optional)

- Playback MP3/WMA/AAC Files from USB Memory (optional) .....32
- About MP3/WMA/AAC File of USB Memory ...32

## iPod/iPhone (optional)

- Connecting an iPod/iPhone.....32
- Setting the iPod Control.....33
- Playback.....33
- Searching for a desired Song .....33
- Direct Search Function .....34
- Select Playlist/Artist/Album/Genre/Composer/Episode .....34
- Alphabet Search Function.....34
- Search Position Memory .....34
- Random Play Shuffle (M.I.X.).....35
- Repeat Play .....35
- Displaying the Text.....35

## Information

In Case of Difficulty.....	36
Basic.....	36
Radio.....	36
CD.....	36
MP3/WMA/AAC.....	36
Audio.....	36
iPod.....	36
Indication for CD Player.....	36
Indication for USB Memory.....	37
Indication for iPod Mode.....	37
BLUETOOTH mode.....	38
Specifications.....	39

---

## Installation and Connections

<b>WARNING.....</b>	<b>40</b>
<b>CAUTION.....</b>	<b>40</b>
<b>PRECAUTIONS.....</b>	<b>40</b>
Installation.....	41
Removal.....	41
Mounting the Microphone.....	42
Connections.....	43

# Operating Instructions

## WARNING

### WARNING

**This symbol means important instructions. Failure to heed them can result in serious injury or death.**

#### **DO NOT OPERATE ANY FUNCTION THAT TAKES YOUR ATTENTION AWAY FROM SAFELY DRIVING YOUR VEHICLE.**

Any function that requires your prolonged attention should only be performed after coming to a complete stop. Always stop the vehicle in a safe location before performing these functions. Failure to do so may result in an accident.

#### **KEEP THE VOLUME AT A LEVEL WHERE YOU CAN STILL HEAR OUTSIDE NOISES WHILE DRIVING.**

Excessive volume levels that obscure sounds such as emergency vehicle sirens or road warning signals (train crossings, etc.) can be dangerous and may result in an accident. LISTENING AT LOUD VOLUME LEVELS IN A CAR MAY ALSO CAUSE HEARING DAMAGE.

#### **DO NOT DISASSEMBLE OR ALTER.**

Doing so may result in an accident, fire or electric shock.

#### **USE ONLY IN CARS WITH A 12 VOLT NEGATIVE GROUND.**

(Check with your dealer if you are not sure.) Failure to do so may result in fire, etc.

#### **KEEP SMALL OBJECTS SUCH AS BATTERIES OUT OF THE REACH OF CHILDREN.**

Swallowing them may result in serious injury. If swallowed, consult a physician immediately.

#### **USE THE CORRECT AMPERE RATING WHEN REPLACING FUSES.**

Failure to do so may result in fire or electric shock.

#### **DO NOT BLOCK VENTS OR RADIATOR PANELS.**

Doing so may cause heat to build up inside and may result in fire.

#### **USE THIS PRODUCT FOR MOBILE 12V APPLICATIONS.**

Use for other than its designed application may result in fire, electric shock or other injury.

#### **DO NOT PLACE HANDS, FINGERS OR FOREIGN OBJECTS IN INSERTION SLOTS OR GAPS.**

Doing so may result in personal injury or damage to the product.

### CAUTION

**This symbol means important instructions. Failure to heed them can result in injury or material property damage.**

#### **HALT USE IMMEDIATELY IF A PROBLEM APPEARS.**

Failure to do so may cause personal injury or damage to the product. Return it to your authorized Alpine dealer or the nearest Alpine Service Centre for repairing.

### PRECAUTIONS

#### **Product Cleaning**

Use a soft dry cloth for periodic cleaning of the product. For more severe stains, please dampen the cloth with water only. Anything else has the chance of dissolving the paint or damaging the plastic.

#### **Temperature**

Be sure the temperature inside the vehicle is between +60°C (+140°F) and -10°C (+14°F) before turning your unit on.

#### **Moisture Condensation**

You may notice the CD playback sound wavering due to condensation. If this happens, remove the disc from the player and wait about an hour for the moisture to evaporate.

#### **Damaged Disc**

Do not attempt to play cracked, warped, or damaged discs. Playing a bad disc could severely damage the playback mechanism.

#### **Maintenance**

If you have problems, do not attempt to repair the unit yourself. Return it to your Alpine dealer or the nearest Alpine Service Station for servicing.

#### **Never Attempt the Following**

Do not grip or pull out the disc while it is being pulled back into the player by the automatic reloading mechanism.

Do not attempt to insert a disc into the unit when the unit power is off.

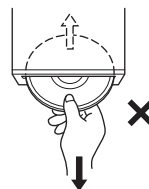

---

## Inserting Discs

Your player accepts only one disc at a time for playback. Do not attempt to load more than one disc.  
Make sure the label side is facing up when you insert the disc. "ERROR" will be displayed on your player if you insert a disc incorrectly. If "ERROR" continues to be displayed even though the disc has been inserted correctly, push the **RESET** switch with a pointed object such as a ballpoint pen.  
Playing a disc while driving on a very bumpy road may result in skips, but this will not scratch the disc or damage the player.

---

## New Discs

To prevent the CD from jamming, "ERROR" is displayed if discs with irregular surfaces are inserted or if discs are inserted incorrectly. When a new disc is ejected immediately after initial loading, use your finger to feel around the inside of the centre hole and outside edge of the disc. If you feel any small bumps or irregularities, this could inhibit proper loading of the disc. To remove the bumps, rub the inside edge of the hole and outside edge of the disc with a ballpoint pen or other such instrument, and then insert the disc again.

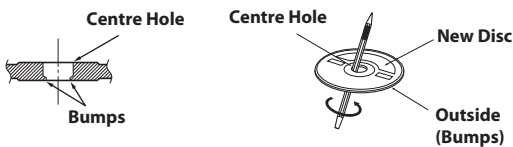

---

## Irregular Shaped Discs

Be sure to use round discs only for this unit and never use any special shaped discs.  
Use of special shape discs may cause damage to the mechanism.



---

## Installation Location

Make sure this unit will not be installed in a location subjected to:

- Direct sun and heat
  - High humidity and water
  - Excessive dust
  - Excessive vibrations
- 

## Correct Handling

Do not drop the disc while handling. Hold the disc so you will not leave fingerprints on the surface. Do not affix tape, paper, or gummed labels to the disc. Do not write on the disc.

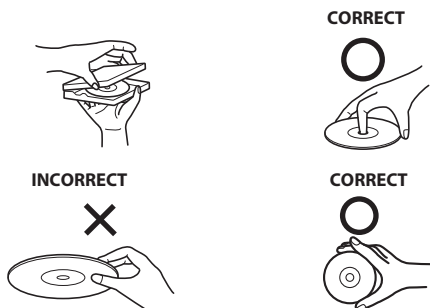

---

## Disc Cleaning

Fingerprints, dust, or soil on the surface of the disc could cause the CD player to skip. For routine cleaning, wipe the playing surface with a clean, soft cloth from the centre of the disc to the outer edge. If the surface is heavily soiled, dampen a clean, soft cloth in a solution of mild neutral detergent before cleaning the disc.



---

## Disc Accessories

There are various accessories available on the market for protecting the disc surface and improving sound quality. However, most of them will influence the thickness and/or diameter of the disc. Using such accessories can cause the disc to be out of standard specifications and may create operational problems. We recommend not using these accessories on discs played in Alpine CD players.

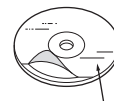

Transparent Sheet

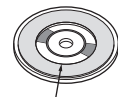

Disc Stabilizer

---

## On handling Compact Discs (CD/CD-R/CD-RW)

- Do not touch the surface.
- Do not expose the disc to direct sunlight.
- Do not affix stickers or labels.
- Clean the disc when it is dusty.
- Make sure that there are no bumps around the disc.
- Do not use commercially available disc accessories.

**Do not leave the disc in the car or the unit for a long time. Never expose the disc to direct sunlight.** Heat and humidity may damage the CD and you may not be able to play it again.

## To customers using CD-R/CD-RW

- If a CD-R/CD-RW cannot be played back, make sure the last recording session was closed (finalised).
  - Finalise the CD-R/CD-RW if necessary, and attempt playback again.
- 

## About media that can be played

Use only compact discs with the label side showing the CD logo marks below.



If you use non-standard compact discs, correct performance cannot be guaranteed.

You can play CD-Rs (CD-Recordables)/CD-RWs (CD-ReWritables) which have been recorded only on audio devices. You can also play CD-Rs/CD-RWs containing MP3 formatted audio files.

- Some of the following CDs may not play on this unit:  
Flawed CDs, CDs with fingerprints, CDs exposed to extreme temperatures or sunlight (e.g., left in the car or this unit), CDs recorded under unstable conditions, CDs on which a recording failed or a re-recording was attempted, copy-protected CDs which do not conform to the audio CD industry standard.

- Use discs with compressed audio files written in a format compatible with this unit. For details, refer to “About MP3/WMA/AAC” on page 15.
- Data files, other than audio, on the disc are ignored and are not played back.

---

### Protecting the USB Port

- Only USB Flash Memory devices or iPod/iPhone can be connected to the USB port on this unit. Correct performance using other USB products cannot be guaranteed. A USB hub is not supported.
- Depending on the shape or size of a USB device, it may not be connected to the USB terminal of this unit—a USB extension (sold separately) is recommended for this connection. Also, avoid connecting USB memory and Front Aux at the same time.
- If a USB device is inserted in the unit, it projects out and may be a danger while driving.  
Use a commercially available USB extension cable, and connect it in a safe way.
- Depending on the connected USB memory device, the unit may not function or some functions may not be performed.
- The audio file format that can be played back on the unit is MP3/WMA/AAC.
- Artist/song name, etc., can be displayed, however some characters may not be correctly displayed.

---

### On Handling USB Flash Memory

#### CAUTION

**Alpine accepts no responsibility for lost data, etc., even if data, etc., is lost while using this product.**

- To prevent malfunction or damage, note the following points.  
Read the USB memory Owner’s Manual thoroughly.
- Fix the USB Memory in a location where driver operation will not be hindered.
- USB memory may not function correctly at high or low temperature.
- Use only certified USB Flash Memory Devices. Please pay attention that even certified USB Memory, may not function correctly depending on its type or state.
- USB memory function is not guaranteed. Use USB memory according to the terms of agreement.
- Depending on the settings of the USB memory type, memory state or encoding software, the unit may not play back or display properly.
- A file that is copy-protected (copyright protection) cannot be played back.
- USB memory may take time to start playback. If there is a particular file other than audio in the USB memory, it may take considerable time before the file is played back or searched.
- The unit can play back “mp3”, “wma” or “m4a” file extensions.
- Do not add the above extensions to a file other than audio data. This non-audio data will not be recognised. The resulting playback may contain noise that can damage speakers and/or amplifiers.
- It is recommended to back up important data on a personal computer.
- Do not remove the USB device while playback is in progress. Change SOURCE to something other than USB, and then remove the USB device to prevent possible damage to its memory.

- *Windows Media and the Windows logo are trademarks, or registered trademarks of Microsoft Corporation in the United States and/or other countries.*
- *iPhone, iPod, iPod classic, iPod nano, and iPod touch are trademarks of Apple Inc., registered in the U.S. and other countries.*
- *“Made for iPod,” and “Made for iPhone,” mean that an electronic accessory has been designed to connect specifically to iPod, or iPhone, respectively, and has been certified by the developer to meet Apple performance standards. Apple is not responsible for the operation of this device or its compliance with safety and regulatory standards. Please note that the use of this accessory with iPod, or iPhone may affect wireless performance.*
- *The BLUETOOTH® word mark and logos are registered trademarks owned by the Bluetooth SIG, Inc. and any use of such marks by Alpine Electronics, Inc. is under licence. Other trademarks and trade names are those of their respective owners.*
- *MPEG Layer-3 audio coding technology licensed from Fraunhofer IIS and Thomson. Supply of this product only conveys a licence for private, non-commercial use and does not convey a licence nor imply any right to use this product in any commercial (i.e. revenue-generation) real time broadcasting (terrestrial, satellite, cable and/or any other media), broadcasting/streaming via internet, intranets and/or other networks or in other electronic content distribution systems, such as pay-audio or audio-on-demand applications. An independent licence for such use is required. For details, please visit <http://www.mp3licensing.com>*
- *Android is a trademark of Google Inc.*



# Getting Started

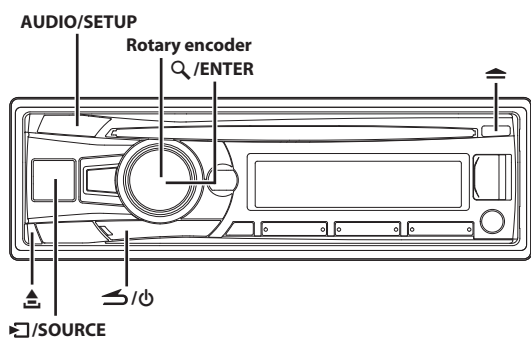



## Accessory List

- Head Unit .....1
- Power Cable .....1
- Microphone .....1
- Mounting Sleeve .....1
- Carrying Case.....1
- Rubber Cap .....1
- Hex Bolt.....1
- Bracket Key .....2
- Screw (M5 × 8) .....4
- Owner's Manual.....1 set

## Turning Power On and Off

Press  to turn on the unit.

### Note

- The unit can be turned on by pressing any other button except  and  (Release).

Press and hold  for at least 2 seconds to turn off the unit.

### Note

- The first time power is turned on, the volume will start from level 12.

## Demonstration Function

This unit has a demonstration feature for display. When Demo mode is set to ON (initial setting), the unit starts the demonstration if there is no operation for 30 seconds.

When installing this unit in a car for the first time, the DEMO OFF screen will be displayed for 30 seconds after turning on the unit.

Press  within 30 seconds to turn off the Demonstration mode\*.

Otherwise, the Demo mode remains ON and the unit starts the demonstration if there is no operation for 30 seconds.

\* The operation is the same as setting DEMO MODE to OFF in the Setup menu. However, if the unit is disconnected from the vehicle's battery, DEMO MODE will be switched to ON automatically when the unit is used next time. If you want to completely close the Demo mode, set DEMO MODE to QUITTE OFF. For details, please refer to "Demonstration" on page 23.

## Source Selection

Press  to change the source.

TUNER → DISC → USB AUDIO\*<sup>1</sup>/iPod\*<sup>2</sup> → BT AUDIO\*<sup>3</sup> → AUXILIARY\*<sup>4</sup> → TUNER

\*<sup>1</sup> Displayed only when no iPod/iPhone is connected.

\*<sup>2</sup> Displayed only when the iPod/iPhone is connected.

\*<sup>3</sup> Displayed only when BT IN is set to ON, refer to "Setting the BLUETOOTH Connection (BT IN)" on page 26.

\*<sup>4</sup> Refer to "Using the Front AUX Input Terminal" on page 20.

## Detaching and Attaching the Front Panel

### Detaching

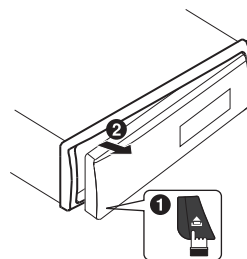

### Notes

- The front panel may become hot in normal usage (especially the connector terminals on the back of the front panel). This is not a malfunction.
- To protect the front panel, place it in the supplied carrying case.
- When detaching the front panel, do not apply excessive force as it may result in malfunction.

## Attaching

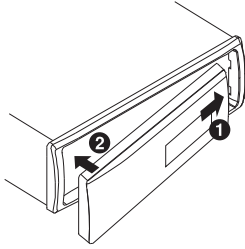

### Notes

- Before attaching the front panel, make sure that there is no dirt or dust on the connector terminals and no foreign object between the front panel and the main unit.
- Attach the front panel carefully, holding the sides of the front panel to avoid pushing buttons by mistake.

## Initial System Start-Up

Be sure to press the **RESET** switch when using the unit for the first time, after changing the car battery, etc.

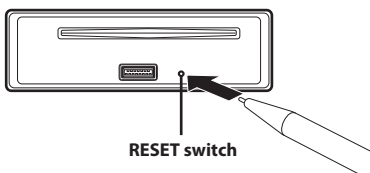

## Adjusting Volume

Turn the **Rotary encoder** until the desired sound is obtained.

## Setting Time

- 1 Press and hold **AUDIO/SETUP** for at least 2 seconds to activate the **SETUP** selection mode.
- 2 Turn the **Rotary encoder** to select **GENERAL**, and then press **Q/ENTER**.
- 3 Turn the **Rotary encoder** to select the **CLOCK ADJ** mode, and then press **Q/ENTER**.  
The time indication will blink.
- 4 Turn the **Rotary encoder** to adjust the hours while the time indication is blinking.
- 5 When the hour has been adjusted, press **Q/ENTER**.
- 6 Turn the **Rotary encoder** to adjust the minutes while the time indication is blinking.
- 7 Press and hold **AUDIO/SETUP** for at least 2 seconds to return to normal mode.

### Notes

- To synchronise the clock to another clock/watch or radio time announcement, press and hold **Q/ENTER** for at least 2 seconds after setting the "hour". Minutes will reset to "00". If the display shows over "30" minutes when you do this, the time will advance one hour.
- Even when **AUTO CLOCK** is set to **ON** (refer to "Setting the Time to automatically be adjusted" on page 23), the time can be adjusted manually. At the same time, if there is an adjustment request from **RDS**, the time will be adjusted automatically by **RDS** data.
- Pressing **↶** will return to the previous mode.
- If no operation is performed for 60 seconds, the unit will return to normal mode automatically.

### Controllable with Remote Control

This unit can be controlled with an optional Alpine remote control. For details, consult your Alpine dealer. Point the optional remote control transmitter at the remote control sensor.

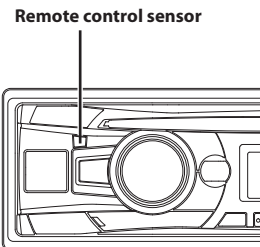

### Connectable to Remote Control Interface Box

With an optional Alpine Steering Wheel Remote Control Interface Box (not included), this unit is controllable from the vehicles steering wheel controls. For details, contact your Alpine dealer.

# Radio

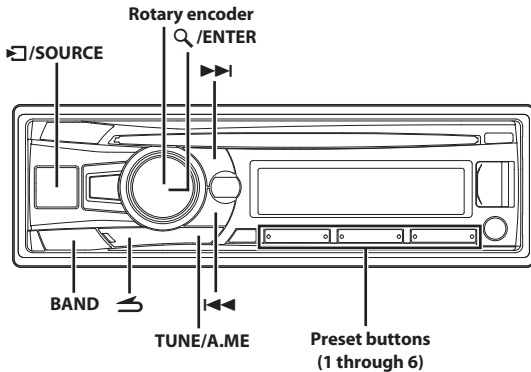

## Listening to Radio

- 1 Press **▶/SOURCE** to select TUNER mode.
- 2 Press **BAND** repeatedly until the desired radio band is displayed.  
FM1 → FM2 → FM3 → MW → LW → FM1
- 3 Press **TUNE/A.ME** to select the tuning mode.  
DX SEEK (Distance mode) → LOCAL SEEK (Local mode) → MANUAL (Manual mode) → DX SEEK  
**Note**
  - The initial mode is Distance mode.**Distance mode:**  
Both strong and weak stations will be automatically tuned in (Automatic Seek Tuning).  
**Local mode:**  
Only strong stations will be automatically tuned in (Automatic Seek Tuning).  
**Manual mode:**  
The frequency is manually tuned in steps (Manual tuning).
- 4 Press **◀◀** or **▶▶** to tune in the desired station.  
Holding down **◀◀** or **▶▶** will change the frequency continuously.

## Presetting Stations Manually

While receiving the station that you want to store, press and hold, for at least 2 seconds, any one of the **preset buttons (1 through 6)** into which you wish to store the station.

The display shows the band, preset number and station frequency memorized.

### Notes

- A total of 30 stations can be stored in the preset memory (6 stations for each band; FM1, FM2, FM3, MW and LW).
- If you store a station in a preset memory which already has a station, the current station will be cleared and replaced with the new station.

## Presetting Stations Automatically

- 1 Press **BAND** repeatedly until the desired radio band is displayed.
- 2 Press and hold **TUNE/A.ME** for at least 2 seconds.  
The frequency on the display continues to change while the automatic memory is in progress. The tuner will automatically seek and store 6 strong stations in the selected band. They will be stored into preset buttons 1 to 6 in order of signal strength. When the automatic memory has been completed, the tuner goes to the station stored in preset location No.1.

### Note

- If no stations are stored, the tuner will return to the original station you were listening to before the auto memory procedure began.

## Tuning to Preset Stations

Select the band, and then press any one of the **station preset buttons (1 through 6)** that has your desired radio station in memory.

The display shows the band, preset number and frequency of the station selected.

## Frequency Search Function

You can search for a radio station by its frequency.

- 1 Press **Q/ENTER** in Radio mode to activate Frequency search mode.
- 2 Turn the **Rotary encoder** to select the desired frequency.
- 3 Press **Q/ENTER** to receive the selected frequency.

### Note

- Press **↵** in the search mode to cancel. Or, the search mode will be cancelled if no operation is performed for 60 seconds.

# RDS

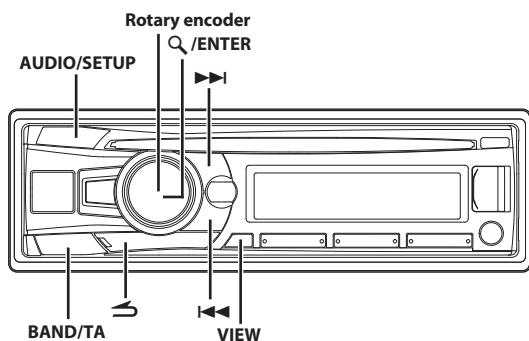

## Turning AF (Alternative Frequencies) ON/OFF

The RDS (Radio Data System) is a radio information system using the 57 kHz subcarrier of regular FM broadcast. The RDS allows you to receive a variety of information such as traffic information, station names, and to automatically re-tune to a stronger transmitter that is broadcasting the same programme.

- 1 Press and hold **AUDIO/SETUP** for at least 2 seconds to activate the **SETUP** selection mode.
- 2 Turn the **Rotary encoder** to select the "TUNER" setup mode, and then press **Q/ENTER**.
- 3 Turn the **Rotary encoder** to select the "AF", and then press **Q/ENTER**.
- 4 Turn the **Rotary encoder** to select the AF (Alternative Frequency) ON or OFF mode.
- 5 Press and hold **AUDIO/SETUP** for at least 2 seconds to return to normal mode.

### Notes

- When the AF ON mode is selected, the "**AF**" indicator lights up and the unit automatically tunes to a strong signal station in the AF list.
- Use the AF OFF mode when automatic re-tuning is not required.

The RDS digital data includes the following:

PI	Programme Identification
PS	Programme Service Name
AF	List of Alternative Frequencies
TP	Traffic Programme
TA	Traffic Announcement
PTY	Programme Type
EON	Enhanced Other Networks

## Receiving RDS Regional (Local) Stations

- 1 Press and hold **AUDIO/SETUP** for at least 2 seconds to activate the **SETUP** mode.
- 2 Turn the **Rotary encoder** to select the **TUNER** mode, and then press **Q/ENTER**.
- 3 Turn the **Rotary encoder** to select the **REGIONAL** mode, and then press **Q/ENTER**.
- 4 Turn the **Rotary encoder** to select **ON** or **OFF**.  
In the **OFF** mode, the unit automatically keeps receiving the related local RDS station.
- 5 Press and hold **AUDIO/SETUP** for at least 2 seconds to return to normal mode.

### Notes

- Press **↶** to return to the previous mode.
- If no operation is performed for 60 seconds, the unit will return to normal mode automatically.

## PI SEEK Setting

- 1 Press and hold **AUDIO/SETUP** for at least 2 seconds to activate the **SETUP** mode.
- 2 Turn the **Rotary encoder** to select the **TUNER** mode, and then press **Q/ENTER**.
- 3 Turn the **Rotary encoder** to select the **PI SEEK** mode, and then press **Q/ENTER**.
- 4 Turn the **Rotary encoder** to select **ON** or **OFF**.
- 5 Press and hold **AUDIO/SETUP** for at least 2 seconds to return to normal mode.

### Notes

- Press **↶** to return to the previous mode.
- If no operation is performed for 60 seconds, the unit will return to normal mode automatically.

## Receiving Traffic Information

- 1 Press and hold **BAND/TA** for at least 2 seconds so that the "**TA**" indicator lights up.
- 2 Press **◀** or **▶** to select your desired traffic information station.  
When a traffic information station is tuned in, the "**TP**" indicator lights up.  
Traffic information is heard only when it is being broadcast. If traffic information is not being broadcast, the unit is set in the standby mode. When a traffic information broadcast begins, the unit automatically receives it and the display shows "TRF-INFO" and PS information.  
When the traffic information broadcast is over, the unit will automatically set in the standby mode.

## Notes

- If the traffic information broadcast signal falls below a certain level, the unit remains in the receiving mode for 1 minute. If the signal remains below a certain level for over 1 minute, the "TA" indicator blinks.
- If you do not want to listen to the traffic information being received, lightly press ◀◀ or ▶▶ to skip that traffic information message. The TA mode will remain in the ON position to receive the next traffic information message.
- If the volume level is changed while receiving traffic information, the changed volume level will be memorized. When traffic information is received next time, the volume level will be automatically adjusted to the level memorized.
- In the TA mode, the SEEK tuning selects only the TP stations.

## Receiving Traffic Information While Playing USB Audio or Radio

- 1 Press and hold BAND/TA for at least 2 seconds so that the "TA" indicator lights up.

- 2 Press ◀◀ or ▶▶ to select a traffic information station if necessary.

When a traffic information broadcast starts, the unit automatically mutes the audio source (such as CD, regular FM broadcast, USB AUDIO, etc.).

When the traffic information broadcast finishes, the unit automatically returns to the original source play before the traffic information broadcast began.

**When traffic information stations cannot be received:**

**In other audio source mode:**

When the TP signal can no longer be received, the traffic information station of another frequency will be selected automatically.

### Note

- The receiver is equipped with the EON (Enhanced Other Networks) function in order to keep track of additional alternate frequencies to the AF list. If the station being received does not broadcast the traffic information, the receiver automatically tunes in the related station that broadcasts the traffic information when it occurs.

- 3 Press and hold BAND/TA for at least 2 seconds to deactivate the Traffic Information mode.

The "TA" indicator goes out.

## Displaying Radio Text

Text messages from a radio station can be displayed.

Press VIEW while receiving FM in the radio mode to select the Radio Text display.

The display will change every time the button is pressed. For details, refer to "Displaying the Text" on page 20.

## CD/MP3/WMA/AAC

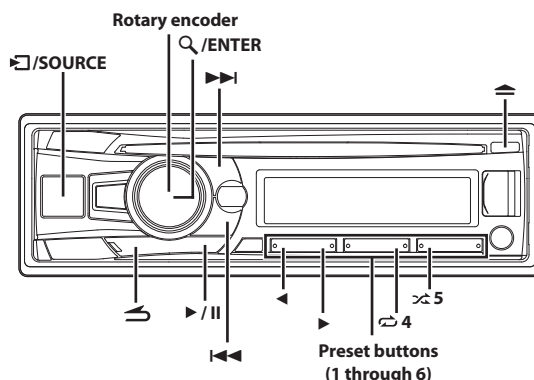

## Playback

- 1 Insert a disc with the label side facing up. The disc will be pulled into the unit automatically.

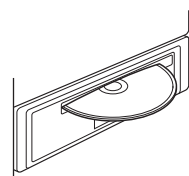

### Note

- When a disc is already inserted, press ◻/SOURCE to switch to the DISC mode.

- 2 While playing back MP3/WMA/AAC, press ◀ or ▶ to select the desired folder.
- 3 Press ◀◀ or ▶▶ to select the desired track (file). Pressing and holding ◀◀ or ▶▶ will fast backward/fast forward track continuously.
- 4 To pause playback, press ▶/II. Pressing ▶/II again will resume playback.
- 5 To eject the disc, press ▲.



### Notes

- Do not remove a CD during its eject cycle. Do not load more than one disc at a time. A malfunction may result from doing either.
- Three-inch (8 cm) CDs cannot be used.
- Any file protected by DRM (Digital Rights Management) copy protection, cannot be played back on this unit.
- The track display for MP3/WMA/AAC data playback is the file numbers recorded on the disc.
- The playback time may not be correctly displayed when a VBR (Variable Bit Rate) recorded file is played back.

---

## Repeat and Random Play

---

**1** During playback, Press  **4** or  **5** repeatedly until the setting appears.

**REPEAT ONE:**

Track/file is played back repeatedly.

**REPEAT FOLDER\*:**

Files in a folder are played back repeatedly.

**MIX FOLDER\*:**

Files in a folder are played back randomly.



**MIX ALL:**

All files in the disc or USB Memory are played back randomly.

\* When MP3/WMA/AAC files are played back.

**2** To cancel repeat or M.I.X. play, select (OFF) with the above procedure.

**Notes**

-  indicator lights up during repeat play mode.
-  indicator lights up during random play mode.

---

## Searching for CD Text

---

On discs utilizing CD Text, songs can be searched and played by using their recorded titles. For discs without CD Text, searches are made using the track numbers associated with each song.

**1** Press  /ENTER during play.

**2** Turn the **Rotary encoder** to select the desired track, and then press  /ENTER.

This will play the selected track.

**Notes**

- Press any of the **preset buttons (1 through 6)** during a search to skip over a calculated percentage of tracks. For details, refer to "Direct Search Function" on page 34.
- Press  in the search mode to cancel. Or, the search mode is cancelled if no operation is performed for 60 seconds.
- When CD Text Search is made during M.I.X. play, the M.I.X. play mode will be cancelled.

---

## Folder/File Name Search (concerning MP3/WMA/AAC)

---

Folder and file names may be searched and displayed during playback.

### Folder Name Search mode



**1** During MP3/WMA/AAC playback, press  /ENTER to activate the search mode.

**2** Turn the **Rotary encoder** to select Folder Name Search mode, and then press  /ENTER.

**3** Turn the **Rotary encoder** to select the desired folder.

**4** Press and hold  /ENTER for at least 2 seconds to play back the first file in the selected folder.

**Notes**

- Press any of the **preset buttons (1 through 6)** during a Folder Name search to skip over a calculated percentage of folders. For details, refer to "Direct Search Function" on page 34.
- Press  in the search mode to return to the previous mode. Or, the search mode is cancelled if no operation is performed for 60 seconds.
- To search for files in the Folder Name Search mode, press  /ENTER. Files in the folder may be searched.
- The root folder is displayed as "\ROOT".
- When Folder Name Search is made during M.I.X. play, the M.I.X. play mode will be cancelled.

### File Name Search mode

**1** During MP3/WMA/AAC playback, press  /ENTER to activate the search mode.

**2** Turn the **Rotary encoder** to select File Name Search mode, and then press  /ENTER.

**3** Select the desired file by turning the **Rotary encoder**.

**4** Press  /ENTER to play back the selected file.

**Notes**

- Press any of the **preset buttons (1 through 6)** during a File Name search to skip over a calculated percentage of files. For details, refer to "Direct Search Function" on page 34.
- Press  in the search mode to return to the previous mode. Or, the search mode is cancelled if no operation is performed for 60 seconds.
- When File Name Search is made during M.I.X. play, the M.I.X. play mode will be cancelled.

---

## Search Position Memory

---

During playback, you can quickly return to the last-selected hierarchy level in the search mode.

Press .

The hierarchy you selected last in the search mode is displayed.

## About MP3/WMA/AAC

### ⚠ CAUTION

**Except for private use, duplicating audio data (including MP3/WMA/AAC data) or distributing, transferring, or copying it, whether for free or for a fee, without permission of the copyright holder is strictly prohibited by the Copyright Act and by international treaty.**

#### What is MP3?

MP3, whose official name is "MPEG Audio Layer 3," is a compression standard prescribed by the ISO, the International Standardization Organization and MPEG which is a joint activity institution of the IEC. MP3 files contain compressed audio data. MP3 encoding is capable of compressing audio data at extremely high ratios, reducing the size of music files to as much as one-tenth their original size. This is achieved while still maintaining near CD quality. The MP3 format realises such high compression ratios by eliminating the sounds that are either inaudible to the human ear or masked by other sounds.

#### What is WMA?

WMA, or "Windows Media™ Audio," is compressed audio data. WMA is similar to MP3 audio data.

#### What is AAC?

AAC is the abbreviation for "Advanced Audio Coding," and is a basic format of audio compression used by MPEG2 or MPEG4.

#### Method for creating MP3/WMA/AAC files

Audio data is compressed using software with MP3/WMA/AAC codecs. For details on creating MP3/WMA/AAC files, refer to the user's manual for that software.

MP3/WMA/AAC files that are playable on this device have the file extensions "mp3" / "wma" / "m4a". Files with no extension cannot be played back (WMA ver. 7.1, 8 and 9 are supported). Protected files are not supported, neither are raw AAC files (using the ".aac" extension). There are many different versions of the AAC format. Confirm that the software being used conforms to the acceptable formats listed above. It's possible that the format may be unplayable even though the extension is valid.

Playback of AAC files encoded by iTunes is supported.

#### Supported playback sampling rates and bit rates

##### MP3

Sampling rates: 48 kHz, 44.1 kHz, 32 kHz, 24 kHz, 22.05 kHz, 16 kHz, 12 kHz, 11.025 kHz, 8 kHz

Bit rates: 8 - 320 kbps

##### WMA

Sampling rates: 48 kHz, 44.1 kHz, 32 kHz

Bit rates: 32 - 192 kbps

##### AAC

Sampling rates: 48 kHz, 44.1 kHz, 32 kHz, 24 kHz, 22.05 kHz, 16 kHz, 12 kHz, 11.025 kHz, 8 kHz

Bit rates: 16 - 320 kbps

This device may not play back correctly depending on sampling rates.

#### ID3 tags/WMA tags

This device supports ID3 tag v1 and v2, and WMA tag.

If tag data is in an MP3/WMA/AAC file, this device can display the title (track title), artist name, and album name ID3 tag/WMA tag data.

This device can only display single-byte alphanumeric characters (up to 30 for ID3 tags and up to 15 for WMA tags) and the underscore. For non-supported characters, "NO SUPPORT" is displayed or the character is displayed as space.

If information contains characters other than ID3 tag information, the audio file may not be played back.

The tag information may not be correctly displayed, depending on the contents.

#### Producing MP3/WMA/AAC discs

MP3/WMA/AAC files are prepared, then written to a CD-R or CD-RW using CD-R writing software. A disc can hold up to 509 files/255 folders. Playback may not be performed if a disc exceeds the limitations described above.

#### Media supported

The media that this device can play back are CD-ROMs, CD-Rs, and CD-RWs.

#### Corresponding File Systems

This device supports discs formatted with ISO9660 Level 1 or Level 2. Under the ISO9660 standard, there are some restrictions to remember. The maximum nested folder depth is 8 (including the root directory). The number of characters for a folder/file name is limited.

Valid characters for folder/file names are letters A-Z (all caps), numbers 0-9, and '\_' (underscore).

This device also can play back discs in Joliet, Romeo, etc., and other standards that conform to ISO9660. However, sometimes the file names, folder names, etc., are not displayed correctly.

#### Formats supported

This device supports CD-ROM XA, Mixed Mode CD, Enhanced CD (CD-Extra) and Multi-Session.

This device cannot correctly play back discs recorded with Track At Once or packet writing.

#### Order of files

Files are played back in the order that the writing software writes them to the disc. Therefore, the playback order may not be what is expected. Verify the writing order in the software's documentation. The playback order of the folders and files is as follows.

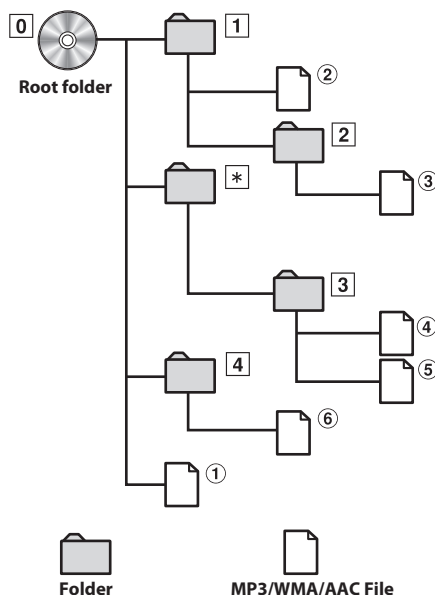

\* The folder No./ folder Name will not be displayed if no readable file is contained in the folder.

## Terminology

### Bit rate

This is the “sound” compression rate specified for encoding. The higher the bit rate, the higher the sound quality, but also the larger the files.

### Sampling rate

This value shows how many times per second the data is sampled (recorded). For example, music CDs use a sampling rate of 44.1 kHz, so the sound is sampled (recorded) 44,100 times per second. The higher the sampling rate, the higher the sound quality, but also the larger the volume of data.

### Encoding

Converting music CDs, WAVE (AIFF) files, and other sound files into the specified audio compression format.

### Tag

Song information such as track titles, artist names, album names, etc., written into MP3/WMA/AAC files.

### Root folder

The root folder (or root directory) is found at the top of the file system. The root folder contains all folders and files. It is created automatically for all burned discs.

## Sound Setting

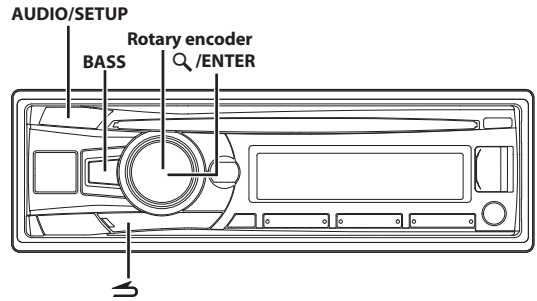

## Adjusting Subwoofer Level/Bass Level/ Treble Level/Balance (Between Left and Right)/Fader (Between Front and Rear)/ Defeat

### 1 Press **AUDIO** repeatedly to choose the desired mode.

Each press changes the mode as follows:

SUBWOOFER<sup>\*1/\*2</sup> → BASS LEVEL<sup>\*2/\*3</sup> → TRE LEVEL<sup>\*2/\*3</sup> → BALANCE  
→ FADER → DEFEAT → VOLUME → SUBWOOFER

\*1 When the subwoofer mode is set to OFF, its level cannot be adjusted, refer to “Turning Subwoofer ON/OFF” on page 18.

\*2 Not displayed when BASS ENGINE SQ mode is selected. Refer to “Switching BASS ENGINE SQ mode” on page 19.

\*3 Adjustable only when DEFEAT is OFF.

Subwoofer	+0 ~ +15
Bass level	-7 ~ +7
Treble level	-7 ~ +7
Balance	L15 ~ R15
Fader	R15 ~ F15
Defeat	ON/OFF
Volume	0 ~ 35

### Note

- If no operation is performed for 5 seconds, the unit automatically returns to normal mode.

### 2 Turn the **Rotary encoder** until the desired sound is obtained in each mode.

By setting DEFEAT ON, previously adjusted level settings of BASS and TREBLE will return to the factory defaults.



## Sound Setting

You can flexibly customize the unit to suit your own preference and usage. From the AUDIO SETUP menu, Audio Setting can be modified.

**Use steps 1 to 5 to select the category you wish to modify. For details on how to change each setting, see the following sections below.**

- 1 Press and hold **AUDIO/SETUP** for at least 2 seconds to activate the **SETUP** mode.
- 2 Turn the **Rotary encoder** to select **AUDIO**, and then press **Q/ENTER**.
- 3 Turn the **Rotary encoder** to select the desired sound setting menu, and then press **Q/ENTER**.  
EQ PRESETS<sup>\*1/\*2/\*3</sup> ↔ BASS ENGIN<sup>\*4</sup> ↔ PARAMETER<sup>\*5</sup> ↔  
9BAND P-EQ<sup>\*1/\*3/\*6</sup> ↔ SOURCE VOL ↔ HPF<sup>\*1/\*3</sup> ↔  
SUBWOOFER<sup>\*7</sup> ↔ SUBW LPF<sup>\*1/\*3/\*8</sup> ↔ SUBW PHASE<sup>\*1/\*8/\*9</sup> ↔  
SUBW SYS<sup>\*3/\*8</sup> ↔ POWER IC ↔ MX SETTING<sup>\*1/\*3</sup> ↔ EQ PRESETS
- 4 Turn the **Rotary encoder** to change the setting, and then press **Q/ENTER**.  
(e.g. Select SUBWOOFER ON or SUBWOOFER OFF)
- 5 Press and hold **AUDIO/SETUP** for at least 2 seconds to return to normal mode.

### Notes

- Adjustment cannot be performed during a call.
- Pressing **↶** returns to the previous Sound menu mode.
- If no operation is performed for 60 seconds, Sound menu mode is cancelled.
- You can access the Sound menu mode directly by pressing **BASS** when BASS ENGIN is set to OFF. Refer to "Setting BASS ENGINE SQ ON/OFF" on page 17.

## Equalizer Presets

10 typical equalizer settings are preset at the factory for a variety of musical source material. USER settings are created in the 9BAND P-EQ mode.

USER ↔ FLAT (Initial setting) ↔ POPS ↔ ROCK ↔ NEWS ↔ JAZZ  
↔ ELEC DANCE ↔ HIP HOP ↔ EASY LIS ↔ COUNTRY ↔  
CLASSICAL

### Note

- The 9-Band, Parametric EQ is used to create the EQ PRESETS settings.

## Setting BASS ENGINE SQ ON/OFF

This function provides a short cut for BASS ENGINE SQ setting. EQ PRESETS, 9BAND P-EQ, etc., will no longer be adjustable when ON is set.

### Setting item: BASS ENGIN

#### Setting contents:

OFF (Initial setting) / ON

#### OFF (MANUAL SET mode):

Adjust each audio effect setting separately.

#### ON (BASS ENGINE SQ mode):

Adjust BASS ENGINE SQ via a short cut.

#### Note

- You can also set BASS ENGINE SQ ON/OFF directly by pressing and holding **BASS**. Refer to "Switching BASS ENGINE SQ mode" on page 19.

## Displaying the BASS ENGINE SQ PARAMETER

After setting BASS ENGIN to ON, you can display the current BASS ENGINE SQ Parameter.

### Setting item: PARAMETER

#### Display contents:

The name of the parameter currently selected is displayed. (INITIAL / TUNEIT A ~ TUNEIT E)

## Adjusting the Parametric Equalizer Curve (9BAND P-EQ)

You can modify the Equalizer settings to create a response curve more appealing to your personal taste.

- 1 After selecting a **BAND (BAND1 ~ BAND9)** from the **9BAND P-EQ** adjustment mode, turn the **Rotary encoder** to select the desired setting item, and then press **Q/ENTER**.  
CENTER FRQ ↔ WIDTH (Q) ↔ LEVEL ↔ CENTER FRQ
- 2 Turn the **Rotary encoder** to select the desired setting value, and then press **Q/ENTER**.
- 3 Press **↶** to return to the previous step.

## Adjusting the Frequency (CENTER FRQ)

### Adjustable frequency bands: 20 Hz to 20 kHz

Band1	20 Hz ~ 100 Hz (63 Hz)
Band2	63 Hz ~ 315 Hz (125 Hz)
Band3	125 Hz ~ 500 Hz (250 Hz)
Band4	250 Hz ~ 1 kHz (500 Hz)
Band5	500 Hz ~ 2 kHz (1 kHz)
Band6	1 kHz ~ 4 kHz (2 kHz)
Band7	2 kHz ~ 7.2 kHz (4 kHz)
Band8	5.8 kHz ~ 12 kHz (8 kHz)
Band9	9 kHz ~ 20 kHz (16 kHz)

## Setting the Bandwidth (WIDTH (Q))

### Setting contents:

3.0 (Initial setting) / 4.0 / 5.0

## Adjusting the Level

### Setting contents:

-7 to +7 (Initial setting: 0)

### Notes

- BAND2 and BAND8 are the same as the Bass and Treble controls. Their Level adjustment can also be controlled by pressing **AUDIO** and selecting Bass Level or Treble Level. Refer to "Adjusting Subwoofer Level/Bass Level/Treble Level/Balance (Between Left and Right)/Fader (Between Front and Rear)/Defeat" on page 16.
- Settings exceeding the frequency of adjacent bands are not available.
- While adjusting the 9BAND P-EQ, you should consider the frequency response of the connected speakers.
- The 9-Band, Parametric EQ is used to create the EQ PRESETS settings.

## Setting the Source Volume Level

The output level of each source is individually adjustable. For example, if the TUNER level sounds lower than CD, its output can be adjusted without affecting the other sources.

### Setting item: SOURCE VOL

### Further setting items: TUNER / DISC / USB / IPOD / BT AUDIO / AUX

### Setting contents:

-14 dB ~ +14 dB

## Adjusting the High Pass Filter

The High Pass Filter on this unit can be adjusted to suit your personal taste.

### Setting item: HPF

### Setting contents:

OFF (Initial setting) / 60 (Hz) / 80 (Hz) / 120 (Hz) / 160 (Hz)

All frequencies above the selected cutoff are output.

## Turning Subwoofer ON/OFF

When the subwoofer is on, you can adjust the subwoofer output level (refer to "Adjusting Subwoofer Level/Bass Level/Treble Level/Balance (Between Left and Right)/Fader (Between Front and Rear)/Defeat" on page 16).

### Setting item: SUBWOOFER

### Setting contents:

ON (Initial setting) / OFF

#### ON:

The subwoofer signal is output from the Subwoofer RCA Connectors (refer to "Connections" on page 43).

#### OFF:

No subwoofer signal is output from the Subwoofer RCA Connectors (refer to "Connections" on page 43).

## Adjusting the Low Pass Filter

The Low Pass Filter on this unit can be adjusted to suit your personal taste.

### Setting item: SUBW LPF

### Setting contents:

OFF (Initial setting) / 60 (Hz) / 80 (Hz) / 120 (Hz) / 160 (Hz)

All frequencies lower than the selected cutoff are output.

## Setting the Subwoofer Phase

The subwoofer output phase is toggled between SUBWOOFER NORMAL (0°) or SUBWOOFER REVERSE (180°). Depending on the installation location of your subwoofer, one of these settings may sound better than the other.

### Setting item: SUBW PHASE

### Setting contents:

NORMAL (Initial setting) / REVERSE

## Setting the Subwoofer System

When the subwoofer is on, you can select either SYSTEM 1 or SYSTEM 2 for the desired subwoofer effect.

### Setting item: SUBW SYS

### Setting contents:

SYSTEM 1 / SYSTEM 2 (Initial setting)

#### SYSTEM 1:

Subwoofer level changes according to the main volume setting.

#### SYSTEM 2:

Subwoofer level change is different from the main volume setting. For example, even at low volume settings, the subwoofer is still audible.

## External Device

### Connecting to an External Amplifier (POWER IC)

When an external amplifier is connected, sound quality can be improved by stopping the power supply of the built-in amplifier.

### Setting item: POWER IC

### Setting contents:

ON (Initial setting) / OFF

#### ON:

The speakers are driven by the built-in amplifier.

#### OFF:

Use this mode when the line output of this unit is used to drive an external amplifier. In this setting, the head unit's internal amplifier is turned OFF and cannot drive speakers.

#### ON:

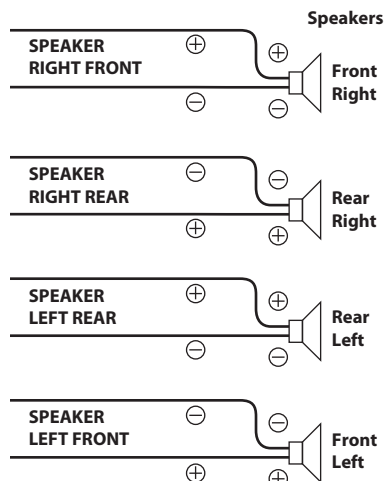

OFF:

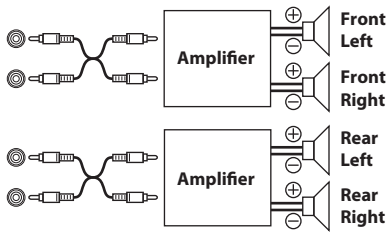

**Note**

- No sound is produced by the system when the power output is set to OFF.

## Setting the Media Xpander mode

MX (Media Xpander) makes vocals or instruments sound distinct regardless of the music source. The CD and iPod, etc. will be able to reproduce the music clearly even in cars with a lot of road noise.

**Setting item: MX SETTING**

**1** Turn the Rotary encoder to select the source to which you want to apply Media Xpander, and then press **Q** / **ENTER**.  
CD ↔ CMPM\* ↔ USB ↔ IPOD ↔ BT AUDIO ↔ AUX ↔ CD

\* Be applied for MP3/WMA/AAC files in disc.

**2** Turn the Rotary encoder to select the Media Xpander level, and then press **Q** / **ENTER**.

OFF ↔ LEVEL 1 ↔ LEVEL 2 ↔ LEVEL 3

**Note**

- There is no MX mode for FM, MW and LW radio.

## BASS ENGINE SQ Function

With the BASS ENGINE SQ function on this unit, several parameters affecting Bass performance are adjusted simultaneously. The Bass Level adjustment varies these parameters uniformly for optimum Bass effect at different levels.

### Switching BASS ENGINE SQ mode

Press and hold **BASS** for at least 2 seconds to switch the sound mode.

BASS ENGINE SQ ↔ MANUAL SET (Initial setting)

**BASS ENGINE SQ:**

Adjust the relevant Bass parameters uniformly and automatically.

**MANUAL SET:**

Adjust each audio effect setting separately and manually.

**Notes**

- This operation can also be performed by selecting BASS ENGIN in Audio Setup mode. Refer to "Setting BASS ENGINE SQ ON/OFF" on page 17.
- You can access the Sound menu mode directly by pressing **BASS** when BASS ENGIN is set to OFF.
- You can set this item via the TuneIt App on a Smartphone. Refer to "Adjusting the sound via the Smartphone" on page 21.

## Adjusting BASS ENGINE SQ Level

With BASS ENGINE SQ ON, adjusting the Bass Level uniformly effects various sound parameters for optimum Bass effect.

**1** Press **BASS** to display the BASS ENGINE SQ Level adjustment screen.

The unit's back lighting changes to white amber during this period.

**2** Turn the Rotary encoder to select the desired level (0-+6).

The initial level is +3.

**Notes**

- Adjustable only when DEFEAT is OFF.
- The Bass parameters affected contain EQ PRESETS, 9BAND EQ, HPF, SUBWOOFER (when set this item via TuneIt App), SUBW LPF, SUBW SYS and MX SETTING. These items are set automatically in BASS ENGINE SQ mode and cannot be adjusted separately.
- From Level 0 to Level 6, the effect of BASS ENGINE SQ increases level by level.
- If no operation is performed for 5 seconds, the unit automatically returns to normal mode.

**About Setup when the external power amplifier is connected.**

In order to optimize the BASS ENGINE SQ, we recommend the following power amplifier setup.

After setting up, you can adjust the BASS ENGINE SQ Level according to the music.

- 1** Set gain of the power amplifier to "MIN".
- 2** Set the Crossover Mode Sector switch to "OFF".
- 3** Set the BASS ENGINE SQ of this unit to "ON", and the BASS ENGINE SQ Level to "+3".
- 4** Play a song of the genre you frequently listen to, and adjust gain of the power amplifier.

# Other Functions

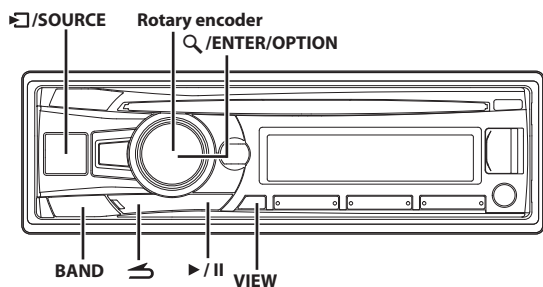

## Displaying the Text

Text information, such as the disc name and the track name, will be displayed if playing a CD text compatible disc. It is also possible to display the folder name, the file name and the tag, etc., while playing MP3/WMA/AAC files.

### Press VIEW.

The display will change every time the button is pressed.

### Note

- When the TEXTSCROLL is set to MANUAL, press and hold VIEW for at least 2 seconds, the current text will be scrolled one time (except Radio mode).

### The display in Radio mode:

#### If there is PS (Programme Service Name)

BAND/PS (Programme Service Name) → ARTIST/SONG →  
 PTY (Programme Type)/PS (Programme Service Name) →  
 RADIO TEXT → BAND/CLOCK → SPECTRUM ANALYZER\*<sup>1</sup> →  
 BAND/PS (Programme Service Name)

#### If there is no PS (Programme Service Name)

BAND/FREQUENCY → ARTIST/SONG →  
 PTY (Programme Type)/FREQUENCY → RADIO TEXT →  
 BAND/CLOCK → SPECTRUM ANALYZER\*<sup>1</sup> → BAND/FREQUENCY

### The display in CD mode:

TRACK NO./ELAPSED TIME → DISC TEXT\*<sup>2</sup>/TRACK TEXT\*<sup>2</sup> →  
 TRACK NO./CLOCK → SPECTRUM ANALYZER\*<sup>1</sup> →  
 TRACK NO./ELAPSED TIME

### The display in MP3/WMA/AAC mode:

FOLDER NO./FILE NO./ELAPSED TIME →  
 FOLDER NAME/FILE NAME → ARTIST NAME\*<sup>3</sup>/SONG NAME\*<sup>3</sup> →  
 ALBUM NAME\*<sup>3</sup>/SONG NAME\*<sup>3</sup> →  
 FOLDER NO./FILE NO./CLOCK → SPECTRUM ANALYZER\*<sup>1</sup> →  
 FOLDER NO./FILE NO./ELAPSED TIME

### The display in BLUETOOTH Audio mode:

BT AUDIO/ELAPSED TIME\*<sup>4</sup> → ARTIST NAME\*<sup>3</sup>/SONG NAME\*<sup>3</sup> →  
 ALBUM NAME\*<sup>3</sup>/SONG NAME\*<sup>3</sup> → BT AUDIO/CLOCK →  
 SPECTRUM ANALYZER\*<sup>1</sup> → BT AUDIO/ELAPSED TIME

\*<sup>1</sup> Displays various patterns according to setting. For details, refer to "Setting the Spectrum analyzer" on page 24.

\*<sup>2</sup> Displayed during playback of a disc with CD text. If there is no Text (Disc Name or Track Name), "DISC TEXT"/"TRACK TEXT" is displayed.

\*<sup>3</sup> ID3 tag/WMA tag

If an MP3/WMA/AAC file contains ID3 tag/WMA tag information, the ID3 tag/WMA tag information is displayed (e.g., song name, artist name, and album name). All other tag data is ignored.

If there is no tag information, "ARTIST"/"ALBUM"/"SONG" is displayed.

\*<sup>4</sup> Depending on the connected Smartphone, the elapsed time may not be displayed.

## About "Text"

Text compatible CDs contain text information such as the disc name and track name. Such text information is referred to as "text".

### Notes

- Some characters may not be displayed correctly with this device, depending on the character type.
- "NO SUPPORT" is displayed when the desired text information cannot be displayed on this unit.
- The text or tag information may not be correctly displayed, depending on the contents.

## Using the Front AUX Input Terminal

Connect a portable music player, etc. by simply connecting it to the input on the front panel. An optional adapter cable is required (standard RCA to 3.5ø mini-phon plug or 3.5ø to 3.5ø mini-phon plug).

Press [ ]/SOURCE, and select the AUXILIARY mode to listen to the portable device.

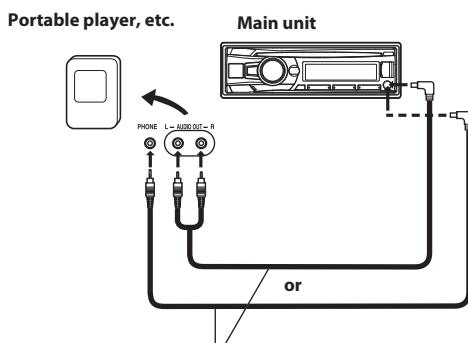

Optional adapter cable (RCA pin plugs [red, white] 3.5ø miniplugs) or (3.5ø miniplugs).

### Notes

- This function is available only when AUX SETUP is set to ON. For details, refer to "Setting the AUX SETUP mode" on page 23.
- Do not connect a USB memory Device and an AUX Input Terminal connector at the same time.

## Option Menu Setting

You can quickly adjust the setting items relevant to the current SOURCE by using Option Menu.

- Press and hold Q/ENTER/OPTION for at least 2 seconds to activate the Option menu of the current source.

### Note

- The option menu varies depending on the source.

**2** Turn the Rotary encoder to select the desired setting item, and then press **Q** /ENTER.

**3** Turn the Rotary encoder to change the setting, and then press **Q** /ENTER.

After the setting, the display will return to the current source automatically.

The following setting items are displayed when MENU LANG is set to ENGLISH. For details, refer to "Setting the Menu Language" on page 23.

#### ■ Setting item:

##### **TUNER mode:**

TUNER SET\*1 ↔ SOURCE VOL\*2 ↔ DIMMER\*3 ↔ TUNER SET

##### **DISC mode:**

CD SET\*4 ↔ SOURCE VOL\*2 ↔ MX SETTING\*5 ↔ DIMMER\*3 ↔ CD SET

##### **USB mode:**

SOURCE VOL\*2 ↔ MX SETTING\*5 ↔ DIMMER\*3 ↔ SOURCE VOL

##### **iPod mode:**

APP DIRECT\*6 ↔ IPOD SET\*7 ↔ SOURCE VOL\*2 ↔ MX SETTING\*5 ↔ DIMMER\*3 ↔ APP DIRECT

##### **AUX mode:**

AUX SET\*8 ↔ SOURCE VOL\*2 ↔ MX SETTING\*5 ↔ DIMMER\*3 ↔ AUX SET

##### **BT AUDIO mode:**

BT SET\*9 ↔ SOURCE VOL\*2 ↔ MX SETTING\*5 ↔ DIMMER\*3 ↔ BT SET

##### **Phone mode (Non-calling mode):**

PHONE SET\*10 ↔ SOURCE VOL\*11 ↔ DIMMER\*3 ↔ PHONE SET

##### **Phone mode (Calling mode):**

MIC GAIN\*12 ↔ CALL SOUND\*12 ↔ SPK SWITCH\*13 ↔ VOICE MUTE\*14 ↔ CALL WAIT\*15 ↔ END CALL\*16 ↔ SOURCE VOL\*11 ↔ DIMMER\*3 ↔ MIC GAIN

\*1 The setting items are the same as TUNER setting in SETUP mode. For details, refer to "SETUP" on page 22.

\*2 You can individually emphasise or weaken the volume level of the current source to create your own tonal preference. The setting values in Option mode and in SETUP mode are linked. Refer to "Setting the Source Volume Level" on page 18. Refer to "Dimmer Control" on page 24.

\*3 PLAY MODE can be selected in this mode. For details, refer to "Playing MP3/WMA/AAC Data (PLAY MODE)" on page 23.

\*4 Refer to "Setting the Media Xpander mode" on page 19.

\*5 Refer to "Setting the iPod Control" on page 33.

\*6 The setting items are the same as iPod setting in SETUP mode. For details, refer to "iPod/iPhone Search Mode Setting" on page 25.

\*7 AUX NAME can be selected in this mode. For details, refer to "Setting the AUX NAME mode" on page 23.

\*8 FW VERSION can be selected in this mode. You can see the current firmware version about BLUETOOTH by using this setting.

\*9 CALL SOUND, CALLER ID, PB UPDATE, PB ORDER, AUTO ANS, SPEAKER SL and FW VERSION can be selected in this mode. For details about these settings, refer to "BLUETOOTH SETUP" on page 26.

\*10 The Hands free phone talk level, ring tone level and microphone gain level can be adjusted by using this setting. The setting values in Option mode and in SETUP mode are linked. Refer to "Adjusting the volume (SOURCE VOL)" on page 27.

\*11 Refer to "Setting the BLUETOOTH sound quality" on page 27.

\*12 While calling, the call sound can be switched between the unit and Smartphone by using this setting. This operation can also be done by pressing **BAND**. Refer to "Call Switching Operation" on page 31.

\*13 While calling, and the Voice Mute is activated, the microphone input will mute instantly and "VOICE MUTE" will blink. This operation can also be done by pressing **▶/II**. Refer to "Muting the microphone input quickly (Voice Mute)" on page 31.

\*14 If there is a waiting call, select this item to display the caller's Name and waiting number (1 or 2). Press **VIEW** and the display will switch.

\*15 Select this item to hang up the call.

#### **Notes**

- Press **↶** to return to the previous mode.
- If no operation is performed for 60 seconds, the unit will return to normal mode automatically.

## Applying TuneIt

This unit's sound tuning is programmable from a connected Smartphone. It is also possible to download specific parameters for certain vehicles from Alpine's TuneIt database stored in the Cloud. Using the TuneIt App, customized parameters can also be uploaded for others to share and rate.

Through this unit, it is also possible to receive and respond to information from Alpine's Social Network Service (SNS) available through the connected Smartphone.

The installed TuneIt App should be launched on the Smartphone before connection to the head unit.

TuneIt, is downloadable from Apple's App Store; the Android user can download it from Google Play. For details, consult your Alpine dealer. Before these operations, set ALPINE APP to USB or BT depending on the connected Smartphone. For details, refer to "Setting the communication mode with a Smartphone (ALPINE APP)" on page 25.

#### **Notes**

- The application programme and related specifications and data may be deleted or terminated without notice.
- Some TuneIt functions may not be available if the Smartphone is not in a service area or receives no signal.

## Adjusting the sound via the Smartphone

After setting the above procedure, the **🔊** indicator lights up, and then you can adjust the unit's sound function on the Smartphone.

**1** Make sure the unit is powered on.

**2** Launch the TuneIt App on the Smartphone. Adjust the unit's sound accordingly on the Smartphone.

During sound setting, the **🔊** indicator may blink.

#### **Notes**

- Volume level cannot be adjusted via the Smartphone.
- The setting cannot be done on both the Smartphone and this unit at the same time. While the sound function of this unit is set via the Smartphone, sound function settings on CDE-185BT will be displayed as "APPCONNECT".
- In some situations, such as the unit is powered off or during a call, etc., sound setting cannot be done via the Smartphone.
- This function may not be available depending on the paired Smartphone.
- Please obey all local traffic laws while using this function.

## Facebook Notification Function



Some functions may be available in a future version of TuneIt.

### Note

- Depending on the paired Smartphone, the following functions may not be available even though the TuneIt version is updated.

## Receiving Notification

When the Smartphone connected to this unit receives notification from Facebook, the unit's back lighting and the  indicator blink (depending on the TuneIt settings on the phone). At the same time, the user's name is shown in the display (20 characters maximum). Play back the notification via TTS (Text To Speech) by the following procedure.



- While receiving Notification from Facebook, press  /SOURCE button.  
Notification Menu screen is displayed.
  - Turn the Rotary encoder to select the desired mode, and then press  /ENTER.  
LIKE\*1 ↔ REPLAY ↔ NEXT ↔ PREVIOUS ↔ TTS VOLUME\*2  
\*1 Not displayed when the received Notification is Message type.  
\*2 It can also be set in SETUP section. For details, refer to "Setting the TTS (Text To Speech) volume" on page 25.
- LIKE:** The Smartphone feedbacks to Facebook with "Like", and meanwhile, the received Wall Posts or Comments are played back by TTS (Text To Speech).
- REPLAY:** To play back Notification by TTS (Text To Speech) again.
- NEXT:** To select the next Notification.
- PREVIOUS:** To select the previous Notification.
- TTS VOLUME:** To adjust the playback volume of TTS (Text To Speech).

### Notes

- Press  to return to the previous mode.
- A new received Notification prompt will last for 30 seconds. If there is no operation within 30 seconds, the unit will return to normal mode.
- In some situations, such as the unit is powered off or during a call, etc., notification of the Smartphone will not be prompted by this unit.

## Displaying Notification List

You can view the received Notification from Facebook in the connected Smartphone via this unit.

- Press and hold  /SOURCE for at least 2 seconds.  
The received Notification will be displayed according to when it was posted.
- Turn the Rotary encoder to select the desired Notification, and then press  /ENTER.
- Then go to step 2 of "Receiving Notification".

### Notes

- When there is no Notification, "NO NOTIF" will be displayed.
- The displayable amount of the Notification list depends on the connected Smartphone.
- If no operation is performed for 60 seconds, the unit will return to normal mode automatically.

# SETUP

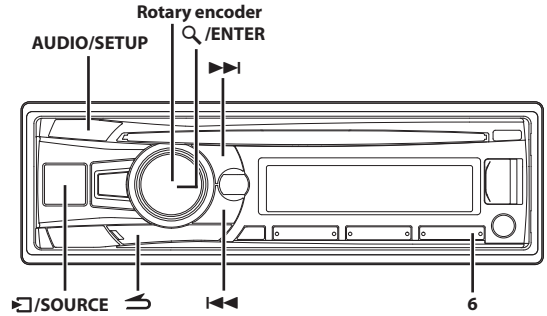

## Setting

You can flexibly customize the unit to suit your own preferences and usage. From the SETUP menu, GENERAL Setting, DISPLAY Setting, etc., can be modified.

**Use steps 1 to 5 to select one of the SETUP modes to modify. See the applicable section below for details about the selected SETUP item.**

- Press and hold **AUDIO/SETUP** for at least 2 seconds to activate the **SETUP** mode.
- Turn the **Rotary encoder** to select the desired item, and then press **Q/ENTER**.  
AUDIO\*1 ↔ GENERAL ↔ DISPLAY ↔ TUNER ↔ IPOD ↔ APP ↔ BLUETOOTH\*2 ↔ AUDIO  
(e.g. Select GENERAL)  
**GENERAL:**  
CLOCK MODE ↔ AUTO CLOCK ↔ CLOCK ADJ\*3 ↔ MENU LANG ↔ AUX SETUP ↔ AUX NAME\*4 ↔ PLAY MODE ↔ STAY ON ↔ DEMO MODE ↔ CLOCK MODE  
**DISPLAY:**  
ILLUMINATI ↔ ANALYZER ↔ DIMMER ↔ TEXTSCROLL ↔ SCROLLTYPE ↔ ILLUMINATI  
**TUNER:**  
AF\*5 ↔ REGIONAL\*6 ↔ PI SEEK\*7 ↔ FM SET ↔ AF  
**IPOD:**  
IPOD LIST  
**APP:**  
ALPINE APP ↔ TTS VOLUME ↔ ALPINE APP  
\*1 Refer to "Sound Setting" on page 17.  
\*2 Refer to "BLUETOOTH SETUP" on page 26.  
\*3 Refer to "Setting Time" on page 10.  
\*4 Displayed only when AUX SETUP is set to ON.  
\*5 Refer to "Turning AF (Alternative Frequencies) ON/OFF" on page 12.  
\*6 Refer to "Receiving RDS Regional (Local) Stations" on page 12.  
\*7 Refer to "PI SEEK Setting" on page 12.
- Select an Item with the **Rotary encoder**, and then press **Q/ENTER**.  
(e.g. Select AUX SETUP)

**4** Turn the **Rotary encoder** to change the setting, and then press **Q/ENTER**.

(e.g. Select ON or OFF)

**5** Press and hold **AUDIO/SETUP** for at least 2 seconds to return to normal mode.

#### Notes

- Press **↶** to return to the previous mode.
- If no operation is performed for 60 seconds, the unit will return to normal mode automatically.

## General Setting

GENERAL is selected on the setup main menu in step 2.

### Setting the Clock Display (CLOCK MODE)

You can select the clock display type, 12-hour or 24-hour, depending on your preference.

■ **Setting item:** CLOCK MODE

**Setting contents:**

24H (Initial setting) / 12H

### Setting the Time to automatically be adjusted

When ON is selected, the clock is adjusted automatically based on the time data sent from the RDS broadcast.

■ **Setting item:** AUTO CLOCK

**Setting contents:**

OFF / ON (Initial setting)

**OFF:**

To adjust it manually.

**ON:**

Adjust the clock automatically based on the time data.

### Setting the Menu Language

Set the language to be displayed on the unit. Six types of font can be selected.

■ **Setting item:** MENU LANG

**Setting contents:**

ENGLISH (Initial setting) / RUSSIAN / GERMAN / FRENCH / SPANISH / ITALIAN / DUTCH

#### Note

- The Owner's Manual only describes the setup menu display when ENGLISH is set.

### Setting the AUX SETUP mode

You can input the audio of an external device, (such as a Portable audio player) to the AUX connector of this unit.

■ **Setting item:** AUX SETUP

**Setting contents:**

OFF / ON (Initial setting)

**OFF:**

When set to OFF, AUX source cannot be selected.

**ON:**

Set to ON when a portable device is connected. If **☐**/SOURCE is pressed and AUX is selected, the sound of the portable device is input to the unit.

### Setting the AUX NAME mode

You can change the AUX NAME display in the SETUP mode.

■ **Setting item:** AUX NAME

**Setting contents:**

AUXILIARY (Initial setting) / TV / DVD / PORTABLE / GAME

### Playing MP3/WMA/AAC Data (PLAY MODE)

This unit can play back CDs containing both CD and MP3/WMA/AAC data (created in Enhanced CD (CD Extra) format). However, in some situations, playback of an enhanced CD may be difficult. In this case, you can choose to play back the CD data session only. When a disc contains both CD and MP3/WMA/AAC data, playback starts from the CD data portion of the disc.

■ **Setting item:** PLAY MODE

**Setting contents:**

CD-DA / CDDA/MP3 (Initial setting)

**CD-DA:**

Only the CD data in Session 1 can be played back.

**CDDA/MP3:**

CD data, MP3/WMA/AAC files in mixed mode, and multi-session discs can be played back.

#### Note

- Perform this setting before inserting a disc. If a disc has already been inserted, remove it first.

### Setting the stay on mode

You can set the delay in turning OFF the unit's power after the vehicle's ignition is turned off (ACC OFF). When you select a mode other than OFF, the music will be paused after you turn the ignition key off (ACC OFF). At the same time, the prompt "PRESS PRESET 6 TO STAY ON" will scroll once. Press **6** within 15 seconds to continue enjoying music for the selected period. If **6** is not pressed, the unit will power off within 15 seconds. During this period, you can only receive a call by operating a paired Smartphone.

■ **Setting item:** STAY ON

**Setting contents:**

OFF (Initial setting) / 5 MIN / 15 MIN / 30 MIN

#### Note

- Note that there is a possibility that the battery may be drained if already weak, during this period.

### Demonstration

This unit has a demonstration feature for the display.

■ **Setting item:** DEMO MODE

**Setting contents:**

ON (Initial setting) / OFF / QUITE OFF

**ON:**

The unit starts the demonstration if there is no operation for 30 seconds.

**OFF:**

Quit the demonstration mode. Note that if this unit is disconnected from the vehicle's battery, the next time you use this unit the DEMO mode will be ON.

**QUITE OFF:**

Quit the demonstration mode completely.

## Display Setting

DISPLAY is selected on the setup main menu in step 2.

### Changing Lighting Colour

You can change the lighting colour of the unit's buttons/display.

#### Setting item: ILLUMINATI

##### Setting contents:

OPTION / CUSTOMIZE

##### OPTION:

A total of 30 colours can be selected.

##### CUSTOMIZE:

If there is no colour you prefer in OPTION, you can customize the colour as follows.

- 1 After entering CUSTOMIZE, turn the Rotary encoder to select a colour (RED, GREEN, BLUE) you want to adjust, and then press **Q** / ENTER.
- 2 The adjusted colour will blink, turn the Rotary encoder to select a value (0-60).  
R is red, G is green and B is blue.
- 3 Press **Q** / ENTER or **↵** to finish the colour setting.
- 4 Repeat steps 1 to 3 to set another colour.

#### Notes

- In step 2, you can switch to another colour setting mode by pressing **◀◀** or **▶▶**.
- The setting values in OPTION mode and CUSTOMIZE mode are linked, when the setting value in CUSTOMIZE is different from the one in OPTION, "USER" will be displayed in OPTION mode.
- During CUSTOMIZE setting, at least one setting value should be greater than 20.

### Setting the Spectrum analyzer

Adjust the display style on the left of the screen according to personal preference. When a song is played, etc., the spectrum will be displayed on the left side of the screen.

#### Setting item: ANALYZER

##### Setting contents:

TYPE A (Initial setting) / TYPE B / TYPE C

##### TYPE A:

Longitudinal Wave

##### TYPE B:

Block

##### TYPE C:

Radial

### Dimmer Control

Set the Dimmer control to AUTO to decrease the illumination brightness of the unit with the head lights of the vehicle ON. This mode is useful if you feel the unit's backlighting is too bright at night.

#### Setting item: DIMMER

##### Setting contents:

MANUAL / AUTO (Initial setting)

### Scroll Setting (TEXTSCROLL)

This CD player can scroll the disc and track names recorded on CD-TEXT discs, as well as the text information of MP3/WMA/AAC files, folder names and tags.

#### Setting item: TEXTSCROLL

##### Setting contents:

MANUAL (Initial setting) / AUTO

##### MANUAL:

The display is scrolled when a disc is loaded or when a track is changed, etc.

##### AUTO:

The current text information of CD, folder, tag, etc. is scrolled automatically.

#### Note

- The unit scrolls CD text names, folder names, file names or tag display.

### Scroll Type Setting

Choose from two scrolling methods. Select the type you prefer.

#### Setting item: SCROLLTYPE

##### Setting contents:

TYPE1 / TYPE2 (Initial setting)

##### TYPE1:

The characters scroll from right to left, a single character at a time.

##### TYPE2:

Words are built up from left to right, a single character at a time. When the display is filled, it is cleared and the remaining words are displayed the same way until all words of the title have been shown.

## Tuner Setting

TUNER is selected on the setup main menu in step 2.

### Setting the TUNER (FM) tone quality (FM SET)

This unit can set your preferred tonal quality for the FM analog radio stations.

#### Setting item: FM SET

##### Setting contents:

HI-FI / NORMAL (Initial setting) / STABLE

##### HI-FI:

High-quality setting

##### NORMAL:

Standard setting

##### STABLE:

Control noise

#### Note

- Noise may be more noticeable when HI-FI is set, depending on the reception status. In this case, the Normal setting is recommended.



## iPod Setting

“IPOD” is selected on the setup main menu in step 2.

## iPod/iPhone Search Mode Setting

The unit allows you to search the iPod/iPhone using nine different search modes.

■ **Setting item:** IPOD LIST

■ **Further setting items:** PLAYLISTS / ARTISTS / ALBUMS / AUDIOBOOKS / PODCASTS / GENRES / COMPOSERS / SONGS / GENIUS MIX

**Setting contents:**

OFF / ON

### Notes

- The search mode for Playlists/Artists/Albums/Podcasts/Genres/ Songs/ Genius Mix is initially set to On. The search mode for Audiobooks/ Composers is initially set to Off.
- For search mode details, refer to “Searching for a desired Song” on page 33.

## Application Setting (APP)

APP is selected on the setup main menu in step 2.

## Setting the communication mode with a Smartphone (ALPINE APP)

Set ALPINE APP to USB when an iPhone is connected, or set to BT when an Android Smartphone is paired.

■ **Setting item:** ALPINE APP

**Setting contents:**

USB (Initial setting) / BT / OFF

### USB:

When an iPhone is connected to CDE-185BT's USB port, you can programme the unit's sound tuning parameters, or communicate with SNS.

### BT:

Set this when an Android Smartphone is paired with this unit via BLUETOOTH technology. At this time, you can programme the unit's sound tuning parameters, or communicate with SNS.

### OFF:

No Smartphone is connected.

### Notes

- It takes a few seconds to validate this function.
- For this function to work properly, specific applications must be installed on your Smartphone before connection. Consult your Alpine dealer or the Alpine website for details.
- Only the iPhone and certain Android Smartphones support this function.

## Setting the TTS (Text To Speech) volume

This function allows for readout of comments, etc., on a Smartphone, and outputs sound from the speakers of the unit.

■ **Setting item:** TTS VOLUME

**Setting contents:**

0 ~ 35

### Note

- The initial volume level is 12.

# BT Hands Free Calling

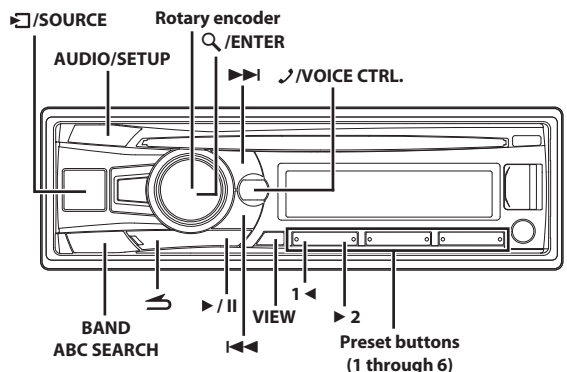

## Setup Before Using

### About BLUETOOTH

BLUETOOTH is a wireless technology allowing communication between a mobile device or personal computer over short distances. This enables a hands-free call or data transmission between BLUETOOTH compatible devices. BLUETOOTH transmission is available in the unlicensed 2.4 GHz spectrum if the distance between devices is within 10 metres. For details, refer to the BLUETOOTH Home page (<http://www.bluetooth.com>).

### Notes

- Depending on the BLUETOOTH version, a BLUETOOTH compatible device may not be able to communicate with this unit.
- Proper function of this unit with all BLUETOOTH compatible devices is not guaranteed. For handling of the BT compatible device, consult your ALPINE dealer or ALPINE website.
- Depending on the surroundings, BLUETOOTH wireless connection may be unstable.
- When you place a call, or perform setup operations, be sure to stop your car in a safe place.
- Depending on the connected BLUETOOTH compatible device(s), the function may differ. Also refer to the Owner's Manual of the connected device(s).
- When you search for this unit using the BLUETOOTH compatible phone, the unit name is displayed as “CDE-185Series”.

### Before Using BLUETOOTH Function

Before using the BLUETOOTH function, the following settings need to be made.

Set BT IN to ON when you want to use Hands-Free phone or BT Audio function. Refer to “Setting the BLUETOOTH Connection (BT IN)” on page 26.

### Note

- Before using BLUETOOTH function, it must be paired with this unit. Refer to “How to connect to a BLUETOOTH compatible device (Pairing)” on page 26.

## How to connect to a BLUETOOTH compatible device (Pairing)

For details on the control from a BLUETOOTH compatible device, refer to the Owner's Manual of the BLUETOOTH compatible device.

- 1 Using your BLUETOOTH compatible device, select the "CDE-185Series" for pairing.

### For BLUETOOTH compatible device with SSP (Secure Simple Pairing)

- 2-1 Turn the Rotary encoder to change the head unit display from "PAIR NO" to "PAIR YES", and then press **Q** / **ENTER**.  
If "PAIR NO" is selected, the connection will be cancelled.

### For BLUETOOTH compatible device without SSP (Secure Simple Pairing)

- 2-2 Input the PIN code ("0000") in a BLUETOOTH compatible device.

#### Note

- The PIN code is fixed as "0000".

- 3 If the pairing was successful, "CONNECTED" is displayed for a few seconds. The head unit then returns to its previous state.

### Auto pairing with an iPod/iPhone

When an iPod/iPhone is connected to the USB port, the unit will automatically pair with it.

- 1 Make sure USB PAIR is set to ON. Refer to "Setting the Auto Pairing with iPod/iPhone" on page 27.
- 2 Connect an iPod/iPhone to this unit's USB port.
- 3 Turn the Rotary encoder to select "PAIR YES", and then press **Q** / **ENTER**.\*  
If "PAIR NO" is selected, the connection will be cancelled.  
\* Depending on the iOS version, you may need to turn on the Bluetooth function manually on the iPod/iPhone side, then perform this step.
- 4 If pairing is successful, "CONNECTED" is displayed for a few seconds. The head unit then returns to its previous state.

#### Notes

- If the device has been paired with this unit previously, it will not USB Pair automatically.
- If the connection is unsuccessful, "FAILED" is displayed.
- After a successful pairing, the two devices should connect automatically whenever the vehicle's ignition is turned ON. If the auto reconnect fails, try to connection manually.
- Set "VISIBLE M" to ON to enable this unit to be recognised by a BLUETOOTH compatible device, refer to "Setting the Visible Mode" on page 27.

## BLUETOOTH SETUP

The following steps 1 to 5 are common to the various BLUETOOTH functions. For details, refer to each individual function.

#### Note

- Set BT IN to ON, and then perform BLUETOOTH SETUP operation. Refer to "Setting the BLUETOOTH Connection (BT IN)" on page 26.

- 1 Press and hold **AUDIO/SETUP** for at least 2 seconds to activate the SETUP mode.
- 2 Turn the Rotary encoder to select "BLUETOOTH", and then press **Q** / **ENTER**.  
The BLUETOOTH setup mode is activated.
- 3 Turn the Rotary encoder to select the desired items, and then press **Q** / **ENTER**.  
BLUETOOTH:  
BT IN\* ↔ USB PAIR ↔ PAIRED DEV ↔ VISIBLE M ↔  
CALL SOUND ↔ CALLER ID ↔ PB UPDATE\* ↔ PB ORDER ↔  
AUTO ANS ↔ SPEAKER SL ↔ FW VERSION ↔  
FW UPDATE\* ↔ BT IN  
\* The items are not displayed during a phone call.
- 4 Turn the Rotary encoder to change the settings.
- 5 Press and hold **AUDIO/SETUP** for at least 2 seconds.  
The SETUP mode is cancelled.

#### Notes

- Press **↶** to return to the previous mode.
- If no operation is performed for 60 seconds, the unit will return to normal mode automatically.

### Setting the BLUETOOTH Connection (BT IN)

With BLUETOOTH technology, you can place a hands-free call by a BLUETOOTH-equipped Smartphone. Audio information of a BLUETOOTH compatible Smartphone, a portable audio player, etc., is controllable/playable wirelessly from this unit.

#### Setting item: BT IN

##### Setting contents:

OFF / ON (Initial setting)



##### OFF:

Hands-Free Phone function and BLUETOOTH Audio function are not used.

##### ON:

Select when you want to pair your BLUETOOTH compatible phone with this unit or use BLUETOOTH Audio function.

#### Note

- When BT IN is set to OFF, the indicators related to Hands-free phone ( battery charge and  signal strength) will not be displayed.

## Setting the Auto Pairing with iPod/iPhone

By setting this item to ON, the unit will auto pair when an iPod/iPhone is connected to this unit via the USB port.

### Setting item: USB PAIR

#### Setting contents:

OFF / ON (Initial setting)

#### OFF:

Turn off the auto pair function.

#### ON:

Auto pair when an iPod/iPhone is connected to this unit via the USB port.

#### Note

- USB Auto-Pairing cannot take place if either device has been paired previously. Make sure the device name of both has been deleted from each device.

## Setting the BLUETOOTH Device

Select one of 5 connected BLUETOOTH compatible devices that you previously registered.











### Setting item: PAIRED DEV

1 Turn the Rotary encoder to select a BLUETOOTH compatible device you want to use (you want to change connection), and then press **Q** / ENTER.

2 Turn the Rotary encoder to select "CONNECT" to connect the selected device.

The connected device is marked with "繋". Select "DISCONNECT" to disconnect this device. Select "CLEAR" when you want to clear the device from the device list.

#### Notes

- If the connection is successfully changed, "CONNECTED" is displayed for 2 seconds and the  indicator lights up, then the display returns to the SETUP screen.
- If a Smartphone is connected to this unit successfully, the  indicator lights up to show the battery charge of the connected Smartphone. The  indicator lights up when the battery charge is about 50%, the  indicator lights up when the battery charge is not enough, and it blinks as a low level warning. The  indicator goes out when the battery is drained. At this time, the BLUETOOTH function is unavailable due to the Smartphone powered off.
- Indicator  (Signal Strength):  
The indicator will display the current signal strength of your service provider. The  indicator blinks when the signal of the connected Smartphone is very weak. The  indicator goes out when the Smartphone is not in service area or receives no signal.
- Depending on the connected Smartphone, the  (battery charge), and  (signal strength) indicators may not be displayed.
- A total of 5 devices can be registered. If a 6th device is registered, the earliest registered device will be deleted automatically.

## Setting the Visible Mode

You can set whether this unit can be recognised or not from a BLUETOOTH compatible device. Normally set this to VISIBLE M ON.

### Setting item: VISIBLE M

#### Setting contents:

ON (Initial setting) / OFF

#### ON:

Enable recognition of this unit from the BLUETOOTH compatible device.

#### OFF:

Disable recognition of this unit from the BLUETOOTH compatible device.

## Setting the BLUETOOTH sound quality

Change these settings to improve the quality of the outgoing or incoming call.

### Setting item: CALL SOUND

### Further setting items: SOURCE VOL / TYPE SET

## Adjusting the volume (SOURCE VOL)

You can emphasise or weaken the volume level of the Phone call, the ring tone and the microphone input to fit your own preferences.

#### Setting contents:

##### PHONE TALK:

-5 dB ~ +5 dB

##### RING TONE:

-5 dB ~ +5 dB

##### MIC GAIN:

-5 dB ~ +5 dB

## Sound Auto setting (TYPE SET)

Depending on your calling environment, choose one of the settings below which gives the best sound quality.

#### Setting contents:

TYPE1 (Initial setting) / TYPE2 / TYPE3 / TYPE4 / TYPE5

##### TYPE1:

Standard Mode (recommended)

##### TYPE2:

Enhances the noise reduction

##### TYPE3:

Enhances the echo-cancel

##### TYPE4:

Enhances both noise reduction and echo-cancel

##### TYPE5:

Weakens both noise reduction and echo-cancel

#### Note

- The functions below are designed to improve the sound quality of the outgoing call.  
Noise reduction: This function can reduce the road noise, but excessive enhancement may affect the sound quality of the call.  
Echo-cancel: This function can reduce the echo, but excessive enhancement may affect the sound quality of the call.

## Setting the caller information display ON/OFF

You can choose whether to use this function according to the following setting.

### Setting item: CALLER ID

#### Setting contents:

ON (Initial setting) / OFF

If you want to keep the ID information of the caller from others, set this item to OFF. Depending on the stored ID information, while you are dialling a number, or while a call is dialling in, only the telephone number will be displayed; During a call, "NO NAME" will be displayed.

## Setting the Phone Book Update

You can update the phone book automatically or manually.

■ **Setting item:** PB UPDATE

■ **Further Setting contents:** AUTO/MANUAL

### Setting the Phone Book Auto Update ON/OFF (AUTO)

When you select AUTO ON in this step, whenever the vehicle's ignition is turned ON or after the phone is connected with this unit, the phone book will be updated automatically.

**Setting contents:**

AUTO OFF / AUTO ON (Initial setting)

**Note**

- "UPDATING" will be displayed during the phone book update.

### Setting the Phone Book Manual Update ON/OFF (MANUAL)

When you select MANUAL YES in this step, the phone book will be updated immediately regardless if the Auto update function is on or off.

**Setting contents:**

MANUAL NO (Initial setting) / MANUAL YES

**Note**

- "UPDATING" will be displayed during the phone book update.

## Changing the Phone book List Order

The phone book is listed alphabetically by the first letter of FIRST or LAST NAME.

Listing by FIRST NAME is the default but LAST NAME can be selected.

■ **Setting item:** PB ORDER

**Setting contents:**

FIRST NAME (Initial setting) / LAST NAME

**Note**

- "WAITING" will be displayed while the Phone book order is switching. You can quit the "WAITING" screen to perform other operations by pressing  when the ordering is still in progress. At this time, the phone book is not accessible. In addition, the ordering may affect the playback of BT AUDIO.

## Setting the Received Calls automatically (Auto Answer)

When a call is received, you can set whether to receive it automatically or not.

■ **Setting item:** AUTO ANS

**Setting contents:**

ON / OFF (Initial setting)

**ON:**

When a call is received, it is answered automatically after about 5 seconds.

**OFF:**

When a call is received, it is not answered automatically. Press  to receive the call.

**Note**

- If the received call setting on the Smartphone is on, the call will be answered automatically even though this setting is set to OFF.

## Selecting the output speaker

Choose the speaker in your vehicle from which you want to hear the call.

■ **Setting item:** SPEAKER SL

**Setting contents:**

ALL (Initial setting) / FRONT-L / FRONT-R / FRONT-LR

**ALL:**

The sound be output from all of speakers in car.

**FRONT-L:**

The sound only be output from the front left speaker.

**FRONT-R:**

The sound only be output from the front right speaker.

**FRONT-LR:**

The sound be output from the front left and front right speaker.

## Displaying the firmware version

The current firmware version will be displayed.

■ **Setting item:** FW VERSION

## Updating the firmware

Future BLUETOOTH firmware updates may become available for phone interoperability.

For information to update your BLUETOOTH firmware, please visit your local Alpine website or choose your country from Alpine Europe top page (<http://www.alpine-europe.com>).

■ **Setting item:** FW UPDATE

**Setting contents:**

NO (Initial setting) / YES

## Hands-Free Phone Control

### About the Hands-Free Phone

Hands-free calls are possible when using a HSP (Head Set Profile) and HFP (Hands-Free Profile) compatible Smartphone with this unit.

**Notes**

- Avoid performing a hands-free call in heavy traffic or on narrow or winding streets.
- Close the windows while calling to reduce background noise.
- If both calling parties are using hands-free devices, or the call is made in a noisy location, difficulty hearing the other person's voice is normal.
- Depending on telephone line conditions or certain mobile devices used, voices may sound unnatural.
- When using a microphone, speak as directly as you can into the microphone to pick up the best sound quality.
- Certain Smartphone features are dependent on the capabilities and settings of your service provider's network. Additionally, certain features may not be activated by your service provider, and/or the provider's network settings may limit the feature's functionality. Always contact your service provider about feature availability and functionality. All features, functionality, and other product specifications, as well as the information contained in the Owner's Manual are based upon the latest available information and are believed to be accurate at the time of printing. Alpine reserves the right to change or modify any information or specifications without notice or obligation.

## Answering a Call

Incoming calls are announced by the received call ring tone and a displayed message (PHONE).

Press **↶** or **↷** /ENTER.

The call starts.

### Notes

- When "AUTO ANS" is set to ON, you can receive a call automatically. Refer to "Setting the Received Calls automatically (Auto Answer)" on page 28.
- While calling, the source sound on the unit is muted. After calling, playback will resume.

## Hanging up the Telephone

Press **↶** or **↷**.

The call finishes.

## Calling

Call History is recorded for the last dialled/received/missed calls (20 records for each). There are various ways of making calls based on the "Calling". The following steps 1 to 5 are common to the various ways of making these calls. For details, refer to each individual category for making calls.

**1** Press **↶**.

The outgoing method list is displayed.

**2** Turn the Rotary encoder to select the outgoing mode.

### Setting contents:

DIALLED / RECEIVED / MISSED / PHONE BOOK

#### DIALLED:

Dialled history

#### RECEIVED:

Received history

#### MISSED:

Missed incoming history

#### PHONE BOOK:

Smartphone phone book

**3** Press **↷** /ENTER.

The outgoing mode is activated, and each mode list is displayed.

### Note

- It may take some time for the list to be displayed after connection. This list may not always update, depending on the connected device.

**4** Turn the Rotary encoder to select a name or a telephone number from the list.

### Note

- You can use Phone book alphabet search function to search a name or number from Phone Book. For details, refer to "Phone book Alphabet Search Function" on page 30.

**5** Press **↷** /ENTER.

The selected telephone number will be called.

If one name has several numbers registered in the telephone book, press **↷** /ENTER after selecting the name\*, and then turn the Rotary encoder to choose the desired number and press **↷** /ENTER, the telephone will be called.

- \* If the name cannot be recognised, "NO NAME" will be displayed.

### Notes

- Press **↶** to return to the previous mode.
- If no operation is performed for 60 seconds, the unit will return to normal mode automatically.

## Redialling a Number In Outgoing History

Previously dialled telephone numbers (maximum number of call record is 20) are stored in dialled calls history. You can redial a number by searching from dialled calls history.

■ **Setting item:** DIALLED

## Dialling a Number In Incoming History

Telephone numbers from received calls (maximum number of call record is 20) are stored in the Received List. You can redial these numbers by searching here.

■ **Setting item:** RECEIVED

## Dialling a Number In Incoming Missed Call History

Telephone numbers for received calls (maximum number of call record is 20) that are missed, are stored in the Missed List. You can redial these numbers by searching here.

■ **Setting item:** MISSED

## Dialling a Number In The Phone Book

Up to 1,000 names (at most 5 telephone numbers for each name) are downloadable from a Smartphone. Dial a call by selecting a person from the phone book list.

■ **Setting item:** PHONE BOOK

### Notes

- The order of the list display depends on the setting of "PB ORDER" (refer to "Changing the Phone book List Order" on page 28).
- If the call history or phone book of the Smartphone is added or deleted while it is connected to the unit, the list displayed on the unit may not be brought up to date. If it is not updated, you cannot correctly place a call.
- You can display the information of a number stored in phone book by pressing **VIEW**. Each press changes the display as Name → Telephone label\* /Telephone NO. → Name  
If the information cannot be obtained, "NO NAME", "NO LABEL" or "NO NUMBER" will be displayed.

- \* The telephone label of a number depends on the number information stored in Phone book of the Smartphone, which includes 4 types-MOBILE, HOME, OFFICE and OTHER.

## Phone book Alphabet Search Function

You can select the first three letters to search for a desired name in phone book list by using the Phone book alphabet search function.

### For example:

Searching a name "Michael James"

The following example explains how the search is performed.

Depending on the setting in PB ORDER (refer to "Changing the Phone book List Order" on page 28), the phone book is listed in first name or last name order. Please search for the first name or last name according to the setting.

- 1 Press **BAND/ABC SEARCH** while in the phone book list, the phone book alphabet search mode is activated.

The letter selection screen is displayed.

- 2 Turn the **Rotary encoder** to select the first letter (e.g. M), and then press **▶▶I**.

- 3 Turn the **Rotary encoder** to select the second letter (e.g. I), and then press **▶▶I**.

- 4 Turn the **Rotary encoder** to select the third letter (e.g. C), and then press **Q/ENTER**.

The names stored in phone book which begin with "MIC" are searched.

- 5 Turn the **Rotary encoder** to select the desired name (e.g. Michael James), and then press **Q/ENTER** to make the call.

### Notes

- The initial setting of the Alphabet Search Function is only applicable to English alphabet characters, but when "RUSSIAN" is set, Phone book alphabet search function is also applicable to Russian letters. Refer to "Setting the Menu Language" on page 23.
- If the selected name has more than one number registered in the phone book, you need to turn the **Rotary encoder** to select the desired number, and then press **Q/ENTER**.
- Press **◀◀** in step 3 or 4 to delete the current entry and return to the previous step.
- You can search for a name by its first letter, first two letters or first three letters. Press **Q/ENTER** after entering the desired number of letters. A list displays the names beginning with the entered letter(s).

## Voice Control Operation

When a Smartphone equipped with voice recognition function is paired with this unit, the Smartphone can be controlled by Voice Control via this unit.

**Press and hold VOICE CTRL. for at least 2 seconds to activate the Voice Recognition mode.**

After the Voice Recognition mode is activated and "SPEAK" is displayed, you can make a phone call, play a song, etc., via this unit by inputting voice control commands\*.

\* Please refer to your Smartphone manual for other voice control commands.

### Notes

- You can perform this operation only when a Voice recognition compatible Smartphone is connected. If the Smartphone is not compatible with the Voice recognition, "NO SUPPORT" is displayed for 2 seconds.
- The Voice recognition performance depends on the Smartphone and mounting location of the microphone. Please pay attention when the microphone is mounted.
- Voice recognition operation depends on the function of the Smartphone. For details, refer to the Owner's Manual of the Smartphone.

- If the person you are calling is not found, "NO CALL" is displayed for 2 seconds.
- Please obey all local traffic laws while using this function.

## Call waiting function

If a second call is received during a current call, you can have the first caller wait momentarily while you take the second call. When you are finished with one call, you can switch to the other one.

**If a second call is received during the current call (call1), the information of second caller (call2) is displayed instead of the current caller's name. Press 2, the call waiting mode is activated.**

In this case, call1 is on hold, while you take call2.

### Notes

- In the call waiting mode, press **1** or **2** to switch between the current call and the person on hold.
- In the call waiting mode, press and hold **1** or **2** for at least 2 seconds to hang up call1 or call2, and the other call will be answered automatically. (The action depends on the paired device.)
- In the call waiting mode, you can press **VIEW** to change the display between waiting number (1or 2) and caller name.

## Preset a number in the Phone Menu (Shortcut dial)

Assign numbers that you dial frequently to presets for quick recall. You can assign up to six frequently called phone numbers to number presets.

**Select a number you want to preset from the Phone Menu list (PHONE BOOK, DIALLED, etc.). Press and hold any one of the preset buttons (1 through 6) as the one that you wish to store the number for at least 2 seconds.**

The phone number you selected is stored in presets.

### Notes

- If the name has several numbers registered in the phone book, press **Q/ENTER** after selecting the name. Turn the **Rotary encoder** to choose the desired number. Press and hold any one of the **preset buttons (1 through 6)** for at least 2 seconds. The selected number is stored as a preset number.
- A total of 30 phone numbers can be stored in the preset memory ( 6 numbers for each Smartphone in the paired device list). If a Smartphone is deleted from the paired device list, the stored preset numbers of this Smartphone are deleted, even when it is paired again.
- If you store a phone number in a preset with a previously stored number, the current number will be cleared and replaced by the new one.

## Dialling the preset number

- 1 Press any one of the **preset buttons (1 through 6)** that has had a number stored in the phone mode.

The information (name/number) stored in the preset station is displayed.

- 2 Press **Q/ENTER** or **↵**.

The stored preset number is dialled directly.

## Adjusting the volume when receiving a Call

While calling, you can adjust the volume.

Turn the **Rotary encoder** to adjust the volume.

### Note

- You may need to increase volume from your regular audio listening source level. However, increasing the volume excessively may result in feedback. Feedback is directly related to the volume. Turning down the volume as low as acceptable, will reduce it. Positioning the microphone in a direction away from the main car speakers (e.g. clipped on sun visor) may also reduce feedback at high volume.

## Muting the microphone input quickly (Voice Mute)

During a call, activating the Voice Mute function will instantly mute the microphone input. Your voice will not be heard by the caller.

During a call, press **▶/||** to mute the microphone input.

Press **▶/||** again to bring the microphone input back to its previous volume level.

## Call Switching Operation

During a call, this function allows you to initiate the transfer of the audio between the Smartphone and the speakers in the car.

During a call, press **BAND** or press and hold **▶/||** for at least 2 seconds to switch the call sound between the unit and Smartphone.

### Note

- Depending on the Smartphone, this operation may not be possible.

## BLUETOOTH Audio Operation

With a Bluetooth compatible Smartphone or music player, it's possible to play and control music playback wirelessly\*.

- \* To play back audio, a Smartphone or a portable player conforming to A2DP (Advanced Audio Distribution Profile) and AVRCP (Audio/Video Remote Control Profile) is required.  
Not all functions work with all devices.

### Notes

- Set **BT IN** to **ON** when you want to use **BLUETOOTH Audio** function. Refer to "Setting the **BLUETOOTH Connection (BT IN)**" on page 26.
- During a call, sound on the **BLUETOOTH audio** source is muted.
- If you operate the **Hands-free phone** (e.g. searching in the phone book) while using the **BLUETOOTH Audio** function, **BLUETOOTH Audio** playback may be affected.

## Recalling the BLUETOOTH Audio Mode

Press **☐/SOURCE** to select the **BT AUDIO** mode.

## Selecting the desired Song

Press **I◀◀** or **▶▶I** to select the desired Song.

Pressing and holding **I◀◀** or **▶▶I** will fast backward/fast forward track continuously.

### Note

- The action depends on the paired device.

## Pausing

Press **▶/||**.

A playback stops. Pressing again will resume a playback.

## Selecting the desired Group

Press **◀** or **▶** to select the desired Group.

### Note

- This function is not available on all paired devices.

## Searching for a desired song

Artist name, album name, etc., may be searched and displayed during playback or pause.

- 1 Press **🔍/ENTER** to activate the search mode.
- 2 Turn the **Rotary encoder** to select the desired Group (Folder), and then press **🔍/ENTER**.
- 3 Turn the **Rotary encoder** to select the desired album, folder, etc., within the selected Group (Folder), and then press **🔍/ENTER**.
- 4 Repeat step 3 if necessary until the desired song is found.

### Notes

- Search mode may differ depending on the paired device.
- The pause mode may be cancelled after the search.
- This function may not be available depending on the paired device.

## USB Memory (optional)

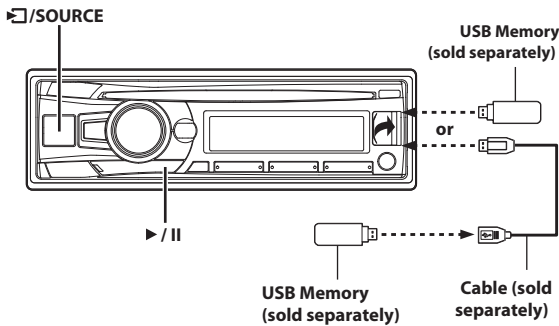

### Playback MP3/WMA/AAC Files from USB Memory (optional)

If a USB Memory device is connected to the unit, MP3/WMA/AAC files can be searched and played back.

- 1 Press **SOURCE** to select the USB AUDIO mode.
- 2 To pause playback, press **II**.  
Pressing **II** again will resume playback.

#### Notes

- This unit plays back files in USB Memory with the same controls and modes used for playback of CDs containing MP3/WMA/AAC. For details, refer to "CD/MP3/WMA/AAC" on page 13.
- Before disconnecting USB Memory, be sure to change to another source or set to pause.
- The playback time may not be correctly displayed when a VBR (Variable Bit Rate) recorded file is played back.

### About MP3/WMA/AAC File of USB Memory

#### Playing back MP3/WMA/AAC

MP3/WMA/AAC files are prepared, then stored to a USB Memory Device. This unit can recognise at most 255 folders and 255 files per folder stored in USB Memory. Playback may not be performed if a USB Memory Device exceeds the limitations described above. Do not make a file's playback time more than 1 hour.

#### Media supported

This device can play back files stored on USB Memory devices designed for USB connection.

#### Corresponding File Systems

This device supports FAT 12/16/32 for USB Memory devices.

## iPod/iPhone (optional)

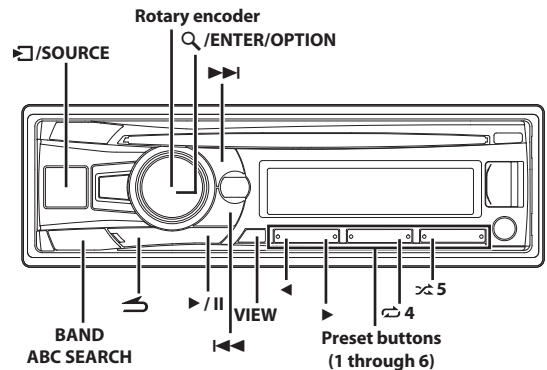

### Connecting an iPod/iPhone

An iPod/iPhone can be connected to this unit by using the Interface cable for iPod (included with iPod/iPhone). When an iPod/iPhone is connected to this unit, you can choose to control the iPod/iPhone using its own controls or by the head unit controls. For details, refer to "Setting the iPod Control" on page 33.

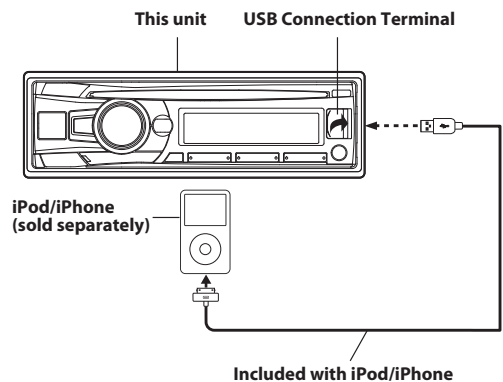

#### Notes

- Internet and telephone functions of the iPod touch or iPhone, etc., can also be used when connecting to this unit. However, using these functions will stop or pause the currently playing songs. At this time do not operate the unit to avoid a malfunction.
- If you connect an iPhone to this unit, it can be used as an iPod. If you use iPhone as a hands-free phone, use the unit in which the BLUETOOTH function is built.
- Do not leave an iPod/iPhone in a car, as its mechanism is sensitive to high temperature and humidity conditions, and damage may result.

#### About iPod/iPhone models usable with this unit

- Confirmed devices regarding Made for iPod. Correct function of earlier versions cannot be guaranteed.
  - iPod nano (7th generation): Ver.1.0.2
  - iPod touch (5th generation): Ver.6.1.3
  - iPod touch (4th generation): Ver.6.1.3
  - iPod nano (6th generation): Ver.1.2
  - iPod touch (3rd generation): Ver.5.1.1
  - iPod nano (5th generation): Ver.1.0.2
  - iPod classic (160 GB) (Late 2009): Ver.2.0.4
  - iPod touch (2nd generation): Ver.4.2.1



iPod nano (4th generation): Ver.1.0.4  
 iPod classic (120 GB): Ver.2.0.1  
 iPod touch (1st generation): Ver.3.1.3  
 iPod nano (3rd generation): Ver.1.1.3  
 iPod classic (80 GB, 160 GB): Ver.1.1.2

- Confirmed devices regarding Made for iPhone. Correct function of earlier versions cannot be guaranteed.  
 iPhone 5: Ver.6.1.3  
 iPhone 4S: Ver.6.1.3  
 iPhone 4: Ver.6.1.3  
 iPhone 3GS: Ver.6.1.3  
 iPhone 3G: Ver.4.2.1  
 iPhone: Ver.3.1.3
- For clarity in identifying your model of iPod, please see Apple's own document "Identifying iPod models" at <http://support.apple.com/kb/HT1353>
- This unit does not support video playback from iPod/iPhone, even using a video-compatible cable.

## Setting the iPod Control

When an iPod/iPhone is connected, operate it from its own controls or from the head unit.

- Press and hold **Q/ENTER/OPTION** for at least 2 seconds during iPod source.

The Option menu for iPod mode is activated.

- Turn the Rotary encoder to select APP DIRECT, and then press **Q/ENTER**.

The iPod control mode will be switched between iPod MODE and HU MODE.

### HU (HEAD UNIT) MODE:

Operate the iPod/iPhone via this unit. This mode allows you to use M.I.X. play, repeat and music search in an iPod/iPhone from the head unit.

#### Note

- In HU MODE, if you operate from an iPod/iPhone, the head unit's display and operations may not correspond with those of the iPod/iPhone.

### iPod MODE:

Operate the iPod/iPhone using its own controls. When iPod MODE is selected, some functions will not be operable via the head unit.

#### Notes

- During HU MODE, you can switch to iPod MODE directly by pressing **BAND**.
- Once the control mode is changed, the iPod/iPhone is paused. Press **▶/||** to continue.

## Playback

- Press **⏮/SOURCE** to switch to the iPod source.

- Press **⏮** or **⏭** to select the desired song.

Pressing and holding **⏮** or **⏭** will fast backward/fast forward the current track.

- To pause playback, press **▶/||**.

Pressing **▶/||** again will resume playback.

#### Notes

- A song playing on the iPod/iPhone while it is connected to this unit will continue to play from where it was paused after disconnection.

- If you listen to an episode from a selected Podcast or Audiobook, the episode can be changed by pressing **⏮** or **⏭**.
- An episode may have several chapters. The chapter can be changed by pressing **⏮⏮** or **⏭⏭**.

## Searching for a desired Song

An iPod/iPhone can contain hundreds of songs. Use one of the search modes listed below, that you deem most effective in finding a desired song.

Each music category has its own individual hierarchy. Use the Playlist/Artist/Album/Song/Podcast/Genre/Composer/Audiobook/Genius Mix List search mode to narrow searches based on the table below.

Hierarchy 1	Hierarchy 2	Hierarchy 3	Hierarchy 4
Playlist	Song	—	—
Artist*	Album*	Song	—
Album*	Song	—	—
Song	—	—	—
Podcast	Episode	—	—
Genre*	Artist*	Album*	Song
Composer*	Album*	Song	—
Audiobook	—	—	—
Genius Mix List	—	—	—

#### For example:

Searching by Artist name

The following example explains how an ARTIST search is performed. Another search mode can be used for the same operation, although the hierarchy differs.

- Press **Q/ENTER** to activate the search selection mode.

- Turn the Rotary encoder to select the ARTIST search mode, and then press **Q/ENTER**.

SHUFFLEALL<sup>\*1</sup> ↔ PLAYLIST ↔ ARTIST ↔ ALBUM ↔ SONG ↔ PODCAST ↔ GENRE ↔ COMPOSER ↔ AUDIOBOOK ↔ GENIUS MIX<sup>\*2/\*3</sup> ↔ SHUFFLEALL

\*1 Refer to "Random Play Shuffle (M.I.X.)" on page 35.

\*2 Depending on the connected iPod/iPhone, Genius Mix function may not be supported.

\*3 When an iPod/iPhone with Genius Mix List created by iTunes is connected to this unit, GENIUS MIX search mode can be used to search a Genius Mix List.

#### Notes

- The display of search mode list varies depending on the setting of iPod LIST. For details, refer to "iPod/iPhone Search Mode Setting" on page 25.

- Turn the Rotary encoder to select the desired Artist, and then press **Q/ENTER**.

- Turn the Rotary encoder to select the desired Album, and then press **Q/ENTER**.

- Turn the Rotary encoder to select the desired Song, and then press **Q/ENTER**.

#### Notes

- This function is unavailable when iPod MODE is selected in "Setting the iPod Control" (refer to "Setting the iPod Control" on page 33). And "iPod CONTROL" will be displayed.
- After pressing and holding **Q/ENTER** for at least 2 seconds while in each hierarchy (except SONG, AUDIOBOOK and GENIUS MIX List hierarchy), all songs of the selected hierarchy are played back.

- Playback [ALL] is only applicable for those categories marked with<sup>Ⓜ</sup>, press and hold **Q/ENTER** for at least 2 seconds to play back all songs in the iPod/iPhone or selected search mode.
- If no operation is performed for 60 seconds, the search mode is cancelled.
- In the search mode, pressing **↶** will return to the previous mode.
- When search is made during M.I.X. play, the M.I.X. play mode will be cancelled.
- When search is made during song downloading on iPhone, "UPDATING" will be displayed for a few second and the search mode will be cancelled.
- "NO SONG" will be displayed if there are no songs in the selected playlist in the PLAYLIST search mode.
- "NO PODCAST" will be displayed if there is no podcast data in the iPod/iPhone in the PODCAST search mode.
- "NO AUDIOBOOK" will be displayed if there is no audiobook data in the iPod/iPhone in AUDIOBOOK search mode.
- "NO GENIUS" will be displayed if there is no genius mix list data in the GENIUS MIX search mode.
- If "iPod name" stored in the iPod/iPhone is selected in the Playlist search mode, and **Q/ENTER** is pressed, you can search for all songs in the iPod/iPhone. Also, if you press and hold **Q/ENTER** for at least 2 seconds, all songs in the iPod/iPhone are played back.
- Depending on the iPod/iPhone, podcast search is not supported.
- Press any of the **preset buttons (1 through 6)** during a search to skip over a calculated percentage of songs. For details, refer to "Direct Search Function" on page 34.
- During search mode, a search can be made quickly by Alphabet search function to find the desired artist or song, etc. For details, refer to "Alphabet Search Function" on page 34.

## Direct Search Function

The unit's direct search function can be used to search for an album, song, etc., more efficiently. In PLAYLIST/ARTIST/ALBUM/SONG/PODCAST/GENRE/COMPOSER/AUDIOBOOK mode, you can quickly target any song.

**In the search mode, press any one of the preset buttons (1 through 6) to quickly skip over a designated percent of your song content.**

### Song search example:

If there are 100 songs in your iPod/iPhone, they are divided into 6 groups using percentages (shown below). These groups are assigned to the preset buttons (1 through 6).

#### Example 1:

Suppose the song you are searching for is located at around the middle (50%) of your library: press button 4 to jump to the 50th song and turn the **Rotary encoder** to find the desired song.

#### Example 2:

Suppose the song you are searching for is located near the end (83%) of your library: press button 6 to jump to the 83rd song and turn the **Rotary encoder** to find the desired song.

	All 100 songs (100%)					
	0%	17%	33%	50%	67%	83%
Preset buttons	1	2	3	4	5	6
Songs	1st song	17th song	33rd song	50th song	67th song	83rd song

### Notes

- This function is inactive during Alphabet Search mode.
- This function is also applicable to CD/MP3/WMA/AAC search.

## Select Playlist/Artist/Album/Genre/Composer/Episode

Playlist/Artist/Album/Genre/Composer/Episode can be easily changed. For example, if you listen to a song from a selected album, the album can be changed.

Press **◀** or **▶** to select the desired Playlist/Artist/Album/Genre/Composer/Episode.

### Notes

- If the song search mode was used to select a song, this function is inactive.
- If an album is selected during an artist search, other albums by that artist are searchable.
- This function is inactive during shuffle (M.I.X.) playback.

## Alphabet Search Function

Quickly find an artist, album, etc. by the first letter in its title or name.

- 1 During search mode, press **BAND/ABC SEARCH** to activate Alphabet Search function.
- 2 Turn the **Rotary encoder** to select the desired initial letter (e.g. select "M"), and then press **Q/ENTER**.  
A list which begins with the selected initial letter is searched.
- 3 Turn the **Rotary encoder** to select the desired item (which begins with initial letter "M"), and then press **Q/ENTER**.  
The item is selected.

### Notes

- The Alphabet Search Function is only applicable to English alphabetic characters.
- While in Alphabet search mode, pressing **↶** will return to the previous mode.
- If the PLAYLIST search mode is used to search for a song, the Alphabet search function is inactive in the song search hierarchy.
- This function is unavailable when GENIUS MIX is selected.

## Search Position Memory

During iPod/iPhone playback, you can quickly return to the last-selected hierarchy level in the search mode.

Press **↶**.

The hierarchy you selected last in the search mode is displayed.

### Note

- This function is unavailable when iPod MODE is selected in "Setting the iPod Control" (refer to "Setting the iPod Control" on page 33).

---

## Random Play Shuffle (M.I.X.)

---

The Shuffle function of the iPod/iPhone is displayed as  on this unit.

### Shuffle Albums:

The songs on each album are played back in the order they were recorded. Upon completion of all the songs on the album, the next album is selected randomly. This continues until all albums have been played.

### Shuffle Songs:

Song shuffle randomly plays back songs within a selected category (playlist, album, etc.). The songs within the category are played just once until all songs have been played.

#### 1 Press 5 .

The songs are played back in random sequence.

MIX ALBUM\*<sup>1</sup> → MIX SONG\*<sup>2</sup> → MIX OFF → MIX ALBUM

\*1 Shuffle Albums.

\*2 Shuffle Songs.

#### 2 To cancel M.I.X. play, select (MIX OFF) with the above procedure.

##### Note

- If a song is selected in the album search mode before selecting M.I.X. play, the songs will not play back randomly even when Shuffle Albums is selected.

### Shuffle ALL:

Shuffle ALL plays all songs in the iPod/iPhone randomly. Any one song does not play back again until all songs have been played back.

#### 1 Press /ENTER to activate the search selection mode.

#### 2 Turn the Rotary encoder to select SHUFFLEALL, and then press /ENTER.

To cancel M.I.X. play, press 5  to select OFF.

##### Notes

- If Shuffle ALL is selected, the selected songs being played back in the search mode are cancelled.
- This function is unavailable when iPod MODE is selected in "Setting the iPod Control" (refer to "Setting the iPod Control" on page 33).

---

## Repeat Play

---

Only Repeat One is available for the iPod/iPhone.

### Repeat One:

A single song is repeatedly played back.

#### 1 Press 4.

The song is played back repeatedly.

REPEAT ONE\* → REPEAT OFF → REPEAT ONE

\* Repeat One.

#### 2 To cancel repeat play, select (REPEAT OFF) with the above procedure.

##### Note

- Depending on the connected iPod, track up/down may be not available during Repeat play.

---

## Displaying the Text

---

You can display the tag information of a song in the iPod/iPhone.

### Press VIEW.

Each press changes the display.

##### Note

- When the TEXTSCROLL is set to MANUAL, press and hold **VIEW** for at least 2 seconds, the current text will be scrolled one time.

TRACK NO./ELAPSED TIME → ARTIST NAME\*<sup>1</sup>/SONG TITLE\*<sup>1</sup> →

ALBUM NAME\*<sup>1</sup>/SONG TITLE\*<sup>1</sup> → TRACK NO./CLOCK →

SPECTRUM ANALYZER\*<sup>2</sup> → TRACK NO./ELAPSED TIME

\*<sup>1</sup> TAG information

"ARTIST"/"ALBUM"/"SONG" is displayed if there is no tag information.

\*<sup>2</sup> Displays various patterns according to setting. For details, refer to "Setting the Spectrum analyzer" on page 24.

##### Notes

- The maximum number of characters for the head unit is 70 (70 byte).
- Some characters may not be correctly displayed.

# Information

## In Case of Difficulty

If you encounter a problem, please turn the power off, then on again. If the unit is still not functioning normally, please review the items in the following checklist. This guide will help you isolate the problem if the unit is at fault. Otherwise, make sure the rest of your system is properly connected or consult your authorized Alpine dealer.

### Basic

#### No function or display.

- Vehicle's ignition is off.
  - If connected following instructions, the unit will not operate with the vehicle's ignition off.
- Improper power lead (Red) and battery lead (Yellow) connections.
  - Check power lead and battery lead connections.
- Blown fuse.
  - Check the fuse of the unit; replace with the proper value if necessary.
- Internal micro-computer malfunctioned due to interference noise etc.
  - Press the **RESET** switch with a ballpoint pen or other pointed article.

### Radio

#### Unable to receive stations.

- No antenna or open connection in cable.
  - Make sure the antenna is properly connected; replace the antenna or cable if necessary.

#### Unable to tune stations in the seek mode.

- You are in a weak signal area.
  - Make sure the tuner is in the DX mode.
- If the area you are in is a primary signal area, the antenna may not be grounded and connected properly.
  - Check your antenna connections; make sure the antenna is properly grounded at its mounting location.
- The antenna may not be the proper length.
  - Make sure the antenna is fully extended; if broken, replace the antenna with a new one.

#### Broadcast is noisy.

- The antenna is not the proper length.
  - Extend the antenna fully; replace it if it is broken.
- The antenna is poorly grounded.
  - Make sure the antenna is grounded properly at its mounting location.

### CD

#### CD Player not functioning.

- Out of operating temperature range +50°C (+120°F) for CD.
  - Allow the vehicle's interior (or trunk) temperature to cool.

#### CD playback sound is wavering.

- Moisture condensation in the CD Module.
  - Allow enough time for the condensation to evaporate (about 1 hour).

#### CD insertion not possible.

- A CD is already in the CD player.
  - Eject the CD and remove it.

- The CD is being improperly inserted.
  - Make sure the CD is being inserted following instructions in the CD Player Operation section.

#### Unable to fast forward or backward the CD.

- The CD has been damaged.
  - Eject the CD and discard it; using a damaged CD in your unit can cause damage to the mechanism.

#### CD playback sound skips due to vibration.

- Improper mounting of the unit.
  - Securely re-mount the unit.
- The disc is very dirty.
  - Clean the disc.
- The disc has scratches.
  - Change the disc.
- The pick-up lens is dirty.
  - Do not use a commercially available lens cleaner disc. Consult your nearest Alpine dealer.

#### CD playback sound skips without vibration.

- The disc is dirty or scratched.
  - Clean the disc; damaged disc should be replaced.

#### Error displays (built-in CD player only).

- Mechanical error
  - Press **▲**. After the error indication disappears, insert the disc again. If the above-mentioned solution does not solve the problem, consult your nearest Alpine dealer.

#### CD-R/CD-RW playback not possible.

- Close session (finalisation) has not been performed.
  - Perform finalisation and attempt playback again.

### MP3/WMA/AAC

#### MP3, WMA or AAC is not played back.

- Writing error occurred. The MP3/WMA/AAC format is not compatible.
  - Make sure the MP3/WMA/AAC has been written in a supported format. Refer to "About MP3/WMA/AAC" on page 15, then rewrite in the format supported by this device.

### Audio

#### The sound is not output from the speakers.

- Unit has no output signal of the internal amplifier.
  - POWER IC is switched to "ON", refer to "Connecting to an External Amplifier (POWER IC)" on page 18.

### iPod

#### iPod does not play and no sound is output.

- The iPod has not been recognised.
  - Reset this unit and the iPod. Refer to "Initial System Start-Up" on page 10. To reset the iPod, refer to the Owner's Manual of the iPod.

### Indication for CD Player

#### NO DISC

- No CD is inserted.
  - Insert a CD.
- Although a disc is inserted, "NO DISC" is displayed and the unit does not start to play or eject the disc.
  - Remove the disc by following these steps:
    - Press the **▲** button again for at least 2 seconds.
  - If the disc still does not eject, consult your Alpine dealer.

## ERROR

- Mechanism error.
  - 1 Press the **▲** button and eject the CD.  
If not ejecting, consult your Alpine dealer.
  - 2 When the error indication remains after ejecting, press the **▲** button again.  
If the error indication still does not turn off after pressing the **▲** button for a few times, consult your Alpine dealer.
- When "ERROR" is displayed:  
If the disc cannot be ejected by pressing **▲**, press the **RESET** switch (refer to "Initial System Start-Up" on page 10) and press **▲** again.  
If the disc still cannot be ejected, consult your Alpine dealer.

## PROTECT

- A copy-protected WMA file was played back.
  - You can only play back non-copy-protected files.

## UNSUPPORTED

- A sampling rate/bit rate not supported by the unit is used.
  - Use a sampling rate/bit rate that is supported by the unit.

## Indication for USB Memory

### ERROR

- Communication error or others
  - You can solve the problem by switching the source, turning ACC off/on, or turning power off/on.

### ERROR-01

- Communication error or boot error, etc.
  - You can solve the problem by switching the source, turning ACC off/on, or turning power off/on.

### ERROR-04

- Abnormal current is run to the USB Flash Memory device.
  - You can solve the problem by turning ACC off/on, or turning power off/on.

## NO USB DEVICE

- A USB Memory is not connected.
  - Make sure the USB Memory device is correctly connected.

## NO FILE

- No song (file) is stored in the USB memory.
  - Connect the USB memory device after storing songs (files).

## UNSUPPORTED

- A sampling rate/bit rate not supported by the unit is used.
  - Use a sampling rate/bit rate that is supported by the unit.

## PROTECT

- A copy-protected WMA file was played back.
  - You can only play back non-copy-protected files.

## NO SUPPORT

- Text information that is not recognisable by the unit is being used.
  - Change the text information to text that is supported by the unit.

## DEVICE ERROR

- An unsupported USB device is connected.
  - Change other USB memory.

## Indication for iPod Mode

### NO SONG

- There are no songs in the iPod/iPhone.
  - Download songs to the iPod/iPhone.

### ERROR-01

- Communication error or boot error, etc.
  - You can solve the problem by switching the source, turning power off/on, or turning ACC off/on.

### ERROR-02

- The iPod/iPhone version is too low.
  - Update the iPod/iPhone version.

### ERROR-03

- The iPod/iPhone is not verified.
  - You can solve the problem by resetting the iPod/iPhone.

### ERROR-04

- Abnormal current is run to the iPod/iPhone.
  - You can solve the problem by reconnecting the iPod/iPhone, turning ACC off/on, or turning power off/on.

## NO USB DEVICE

- The iPod/iPhone is not connected.
  - Make sure the iPod/iPhone is correctly connected and the cable is not bent excessively.

## UPDATING

- The search mode is activated during song downloading.
  - No necessary operation.

## **BLUETOOTH mode**

### **NO UNIT**

- The BLUETOOTH device is not connected.
    - Connect the BLUETOOTH device.
-

## Specifications

### FM TUNER SECTION

Tuning Range	87.5 ~ 108.0 MHz
Mono Usable Sensitivity	0.7 $\mu$ V
Alternate Channel Selectivity	80 dB
Signal-to-Noise Ratio	65 dB
Stereo Separation	35 dB
Capture Ratio	2.0 dB

### MW TUNER SECTION

Tuning Range	531 ~ 1,602 kHz
Sensitivity (IEC Standard)	25.1 $\mu$ V/28 dB

### LW TUNER SECTION

Tuning Range	153 ~ 281 kHz
Sensitivity (IEC Standard)	31.6 $\mu$ V/30 dB

### CD PLAYER SECTION

Frequency Response	5 ~ 20,000 Hz ( $\pm$ 1 dB)
Wow & Flutter (% WRMS)	Below measurable limits
Total Harmonic Distortion	0.008% (at 1 kHz)
Dynamic Range	95 dB (at 1 kHz)
Signal-to-Noise Ratio	105 dB
Channel Separation	85 dB (at 1 kHz)

### USB SECTION

USB requirements	USB 1.1/2.0
Max. Power Consumption	Smartphone charge-capable
USB Class	Mass Storage
File System	FAT 12/16/32
MP3 Decoding	MPEG AUDIO Layer-3
WMA Decoding	Windows Media™ Audio
AAC Decoding	AAC-LC format “.m4a” file

### PICKUP

Wave length	795 nm
Laser power	CLASS I

### BLUETOOTH SECTION

BLUETOOTH Specification	Bluetooth v2.1 + EDR
Output Power	+4 dBm Max. (Power class 2)
Profile	HFP (Hands-Free Profile) HSP (Head Set Profile) A2DP (Advanced Audio Distribution Profile) AVRCP (Audio/Video Remote Control Profile)

### GENERAL

Power Requirement	14.4 V DC (11 ~ 16 V allowable)
Maximum Power Output	50 W $\times$ 4
Maximum Pre-Output Voltage	2 V/10 k ohms
Bass	$\pm$ 9.1 dB at 100 Hz
Treble	$\pm$ 9.1 dB at 10 kHz
Weight	1.37 kg (3 lbs)

### CHASSIS SIZE

Width	178 mm (7")
Height	50 mm (2")
Depth	161.5 mm (6-3/8")

### NOSEPIECE SIZE

Width	170 mm (6-3/4")
Height	45 mm (1-3/4")
Depth	24 mm (15/16")

### Note

- Due to continuous product improvement, specifications and design are subject to change without notice.

### ⚠ CAUTION



(Bottom side of player)

---

---

# Installation and Connections

Before installing or connecting the unit, please read the following and refer to "Operating Instructions" on page 6 for proper use.

## WARNING

---

### MAKE THE CORRECT CONNECTIONS.

Failure to make the proper connections may result in fire or product damage.

---

### USE ONLY IN CARS WITH A 12 VOLT NEGATIVE GROUND.

(Check with your dealer if you are not sure.) Failure to do so may result in fire, etc.

---

### BEFORE WIRING, DISCONNECT THE CABLE FROM THE NEGATIVE BATTERY TERMINAL.

Failure to do so may result in electric shock or injury due to electrical shorts.

---

### DO NOT SPLICE INTO ELECTRICAL CABLES.

Never cut away cable insulation to supply power to other equipment. Doing so will exceed the current carrying capacity of the wire and result in fire or electric shock.

---

### DO NOT DAMAGE PIPE OR WIRING WHEN DRILLING HOLES.

When drilling holes in the chassis for installation, take precautions so as not to contact, damage or obstruct pipes, fuel lines, tanks or electrical wiring. Failure to take such precautions may result in fire.

---

### DO NOT USE BOLTS OR NUTS IN THE BRAKE OR STEERING SYSTEMS TO MAKE GROUND CONNECTIONS.

Bolts or nuts used for the brake or steering systems (or any other safety-related system), or tanks should NEVER be used for installations or ground connections. Using such parts could disable control of the vehicle and cause fire etc.

---

### KEEP SMALL OBJECTS SUCH AS BATTERIES OUT OF THE REACH OF CHILDREN.

Swallowing them may result in serious injury. If swallowed, consult a physician immediately.

---

### DO NOT INSTALL IN LOCATIONS WHICH MIGHT HINDER VEHICLE OPERATION, SUCH AS THE STEERING WHEEL OR SHIFT LEVER.

Doing so may obstruct forward vision or hamper movement etc. and results in serious accident.

---

## CAUTION

---

### HAVE THE WIRING AND INSTALLATION DONE BY EXPERTS.

The wiring and installation of this unit requires special technical skill and experience. To ensure safety, always contact the dealer where you purchased this product to have the work done.

---

### USE SPECIFIED ACCESSORY PARTS AND INSTALL THEM SECURELY.

Be sure to use only the specified accessory parts. Use of other than designated parts may damage this unit internally or may not securely install the unit in place. This may cause parts to become loose resulting in hazards or product failure.

---

### ARRANGE THE WIRING SO IT IS NOT CRIMPED OR PINCHED BY A SHARP METAL EDGE.

Route the cables and wiring away from moving parts (like the seat rails) or sharp or pointed edges. This will prevent crimping and damage to the wiring. If wiring passes through a hole in metal, use a rubber grommet to prevent the wire's insulation from being cut by the metal edge of the hole.

---

### DO NOT INSTALL IN LOCATIONS WITH HIGH MOISTURE OR DUST.

Avoid installing the unit in locations with high incidence of moisture or dust. Moisture or dust that penetrates into this unit may result in product failure.

---

## PRECAUTIONS

- Be sure to disconnect the cable from the (-) battery post before installing your CDE-185BT. This will reduce any chance of damage to the unit in case of a short-circuit.
- Be sure to connect the colour coded leads according to the diagram. Incorrect connections may cause the unit to malfunction or damage to the vehicle's electrical system.
- When making connections to the vehicle's electrical system, be aware of the factory installed components (e.g. on-board computer). Do not tap into these leads to provide power for this unit. When connecting the CDE-185BT to the fuse box, make sure the fuse for the intended circuit of the CDE-185BT has the appropriate amperage. Failure to do so may result in damage to the unit and/or the vehicle. When in doubt, consult your Alpine dealer.
- The CDE-185BT uses female RCA-type jacks for connection to other units (e.g. amplifier) having RCA connectors. You may need an adaptor to connect other units. If so, please contact your authorized Alpine dealer for assistance.
- Be sure to connect the speaker (-) leads to the speaker (-) terminal. Never connect left and right channel speaker cables to each other or to the vehicle body.

---

### IMPORTANT

Please record the serial number of your unit in the space provided below and keep it as a permanent record. The serial number or the engraved serial number is located on the bottom of the unit.

SERIAL NUMBER: [	]
INSTALLATION DATE: [	]
INSTALLATION TECHNICIAN: [	]
PLACE OF PURCHASE: [	]



# Installation

**To prevent external noise from entering the audio system.**

- Locate the unit and route the leads at least 10 cm away from the car harness.
- Keep the battery power leads as far away from other leads as possible.
- Connect the ground lead securely to a bare metal spot (remove any paint, dirt or grease if necessary) of the car chassis.
- If you add an optional noise suppressor, connect it as far away from the unit as possible. Your Alpine dealer carries various noise suppressors, contact them for further information.
- Your Alpine dealer knows best about noise prevention measures so consult your dealer for further information.

## ⚠ CAUTION

When you install this unit in your car, do not remove the detachable front panel. If the detachable front panel is removed during installation, you might press too hard and warp the metal plate that holds it in place. The main unit must be mounted within 35 degrees of the horizontal plane, back to front.

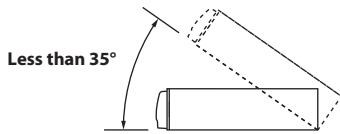

- 1 Remove the mounting sleeve from the main unit (refer to "Removal" on page 41). Slide the mounting sleeve into the dashboard and fix it with the metal shackles.

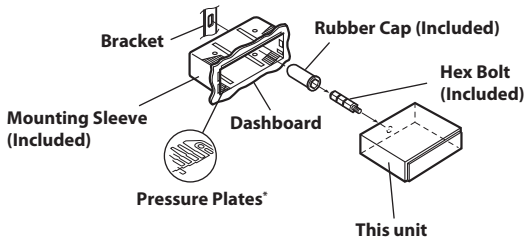

\* If the installed mounting sleeve is loose in the dashboard, the pressure plates may be bent slightly to remedy the problem.

- 2 When your vehicle has the Bracket, mount the long hex bolt onto the rear panel of the CDE-185BT and put the Rubber Cap on the hex bolt. If your vehicle does not have the Mounting Support, reinforce the head unit with the metal mounting strap (not supplied). Connect all the leads of the CDE-185BT according to details described in the CONNECTIONS section.

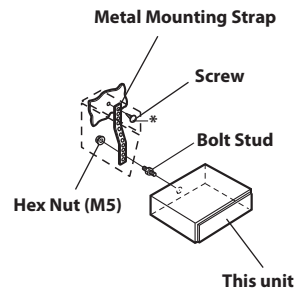

\* For the screw\*, provide a proper screw to the chassis installing location.

- 3 Slide the CDE-185BT into the dashboard until it clicks. This ensures that the unit is properly locked and will not accidentally come out from the dashboard. Install the detachable front panel.

## Removal

- 1 Remove the detachable front panel.
- 2 Insert the bracket keys into the unit, along the guides on either side. The unit can now be removed from the mounting sleeve.

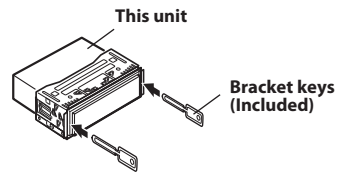

- 3 Pull the unit out, keeping it unlocked as you do so.

### JAPANESE CAR

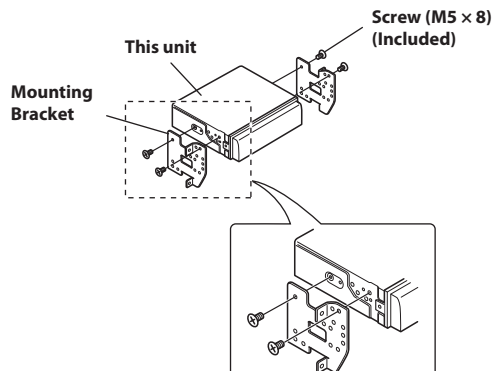
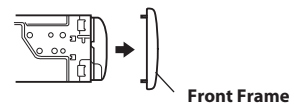

---

## Mounting the Microphone

---

For the sake of safety, mount the microphone in the following location.

- In a stable and secure location.
- In a location that does not inhibit safely driving the vehicle.
- Mount the microphone in a location where the driver's voice can easily be picked up.

Choose a location for the microphone that can easily pick up the drivers voice. Requiring the driver to move towards the microphone for audibility causes a distraction that could be dangerous.



- ① **Remote Turn-On Lead (Blue/White)**  
Connect this lead to the remote turn-on lead of your amplifier or signal processor.
- ② **Switched Power Lead (Ignition) (Red)**  
Connect this lead to an open terminal on the vehicle's fuse box or another unused power source which provides (+) 12V only when the ignition is turned on or in the accessory position.
- ③ **Ground Lead (Black)**  
Connect this lead to a good chassis ground on the vehicle. Make sure the connection is made to bare metal and is securely fastened using the sheet metal screw provided.
- ④ **Power Antenna Lead (Blue)**  
Connect this lead to the +B terminal of your power antenna, if applicable.  
**Note**
  - *This lead should be used only for controlling the vehicle's power antenna. Do not use this lead to turn on an amplifier or a signal processor, etc.*
- ⑤ **Dimmer Lead (Orange)**  
This lead may be connected to the vehicle's instrument cluster illumination lead. This will enable the vehicle's dimmer control to dim the backlighting of the unit.
- ⑥ **Battery Lead (Yellow)**  
Connect this lead to the positive (+) post of the vehicle's battery.
- ⑦ **ISO Power Supply Connector**
- ⑧ **ISO Connector (Speaker Output)**
- ⑨ **Left Rear (+) Speaker Output Lead (Green)**
- ⑩ **Left Rear (-) Speaker Output Lead (Green/Black)**
- ⑪ **Left Front (+) Speaker Output Lead (White)**
- ⑫ **Left Front (-) Speaker Output Lead (White/Black)**
- ⑬ **Right Front (-) Speaker Output Lead (Grey/Black)**
- ⑭ **Right Front (+) Speaker Output Lead (Grey)**
- ⑮ **Right Rear (-) Speaker Output Lead (Violet/Black)**
- ⑯ **Right Rear (+) Speaker Output Lead (Violet)**
- ⑰ **Fuse Holder (10A)**
- ⑱ **MIC Input Connector**  
To Microphone.
- ⑲ **Steering Remote Control Interface Connector**  
To steering remote control interface box. For details, contact your Alpine dealer.
- ⑳ **Antenna Receptacle**
- ㉑ **Microphone (Included)**
- ㉒ **Front Output RCA Connectors**  
RED is right and WHITE is left.
- ㉓ **Rear Output RCA Connectors**  
RED is right and WHITE is left.
- ㉔ **Subwoofer Output RCA Connectors**  
RED is right and WHITE is left.
- ㉕ **Power Supply Connector**
- ㉖ **RCA Extension Cable (sold separately)**
- ㉗ **Front AUX Input Terminal**  
This terminal allows for input of audio from an external device (such as a portable player), using a commercially-available converter cable.
- ㉘ **Front USB Terminal**  
Connect this to an USB Memory or to an iPod/iPhone.

**About the Rules of Bluetooth Electromagnetic Radiation Regulation**



**Declaration of Conformity**

## DECLARATION OF CONFORMITY

In accordance with Annex IV of the EU directive 1999/5/EC

declare under our responsibility that the product: **CD Player with Radio Receiver**

Type: **14BT60**

**I**

Intended Purpose **Equipment Class**

complies with the appropriate essential requirements of the Article 3 of the R&TTE and the other relevant provisions, when used for its intended purpose.

Health and Safety requirements contained in Article 3 (1) a)

**EN 60950-1:2006+A11:2009+A1:2010+A12:2011**

Information technology equipment - Safety

Protection requirements with respect to electromagnetic compatibility Art.3 (1) b)

**EN 301 489-1 V1.9.2**, Electromagnetic compatibility and Radio spectrum Matters (ERM); ElectroMagnetic Compatibility (EMC) standard for radio equipment and services; Part 1: Common technical requirements

**EN 301 489-17 V2.1.1**, Electromagnetic compatibility and Radio spectrum Matters (ERM); ElectroMagnetic Compatibility (EMC) standard for radio equipment and services; Part 17: Specific conditions for 2,4 GHz wideband transmission systems and 5 GHz high performance RLAN equipment

Means of the efficient use of the radio frequency spectrum Art.3 (2)

**EN 300 328 V1.7.1**, Electromagnetic compatibility and Radio Spectrum Matters (ERM); Wideband Transmission systems; Data transmission equipment operating in the 2,4 GHz ISM band and using spread spectrum modulation techniques; Part 2: Harmonized EN covering essential requirements under article 3.2 of the R&TTE Directive

Iwaki, Japan. September 27, 2013

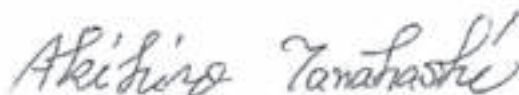

Place, date of issue

Akihiro Tanahashi : Global Engineering Strategy Office