

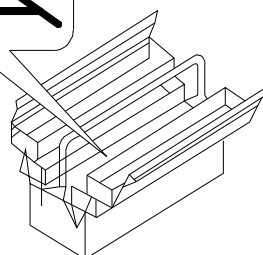

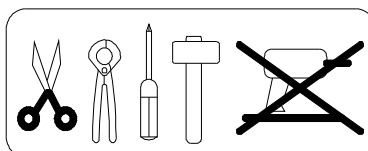

- |                                       |                                   |
|---------------------------------------|-----------------------------------|
| <b>D</b> Montageanleitung             | <b>GB</b> Assembly instructions   |
| <b>NL</b> Handleiding voor de montage | <b>PL</b> Instrukcja montazu      |
| <b>TR</b> Montaj talimati             | <b>RU</b> Инструкция по монтажу   |
| <b>FR</b> Notice de montage           | <b>IT</b> Istruzioni di montaggio |
| <b>CS</b> Montážní návod              | <b>SK</b> Návod na montáž         |
| <b>HU</b> Szerelési útmutató          | <b>RO</b> Instrucțiuni de montaj  |

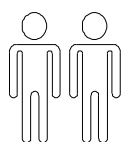
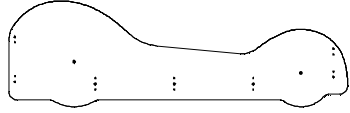
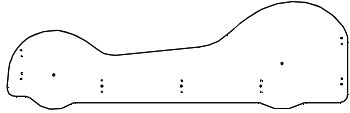
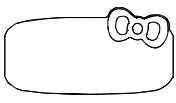
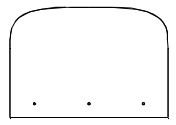
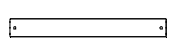
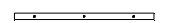

# SCLB200

ITEM NO.	MEASUREMENT	QTY	SHAPE	CARTON NO.
①	2130 X 600 X 15	X1		1-4
②	2130 X 600 X 15	x1		1-4
③	930 X 446 X 15	x1		2-4
④	930 X 600 X 15	x1		2-4
⑤	930 X 98 X 15	x3		2-4
⑥	900 x 40 x 15	x2		2-4
⑦	70 x 70 x 15	x4		3-4
⑧	400 X 400 X 15	x2		3-4
⑨	312 X 312 X 15	x2		3-4
⑩	2007 X 930 X 12	x1		4-4

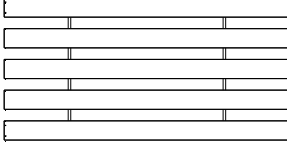
2010x930

SCLB200 20F7

Ver1.013

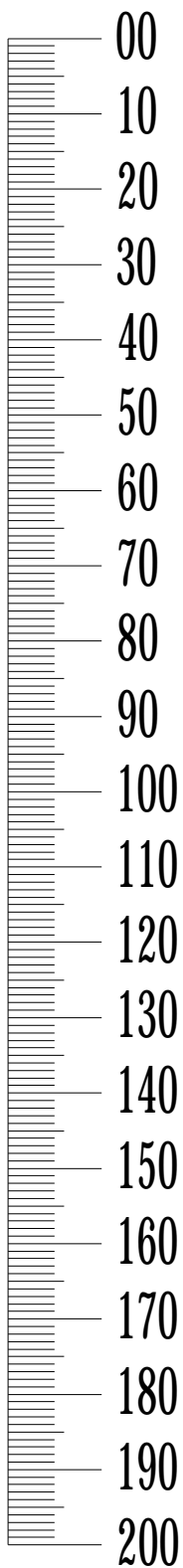

Service • Asistenza • Dienstverlening • Serwis  
Servis • Szerviz • Сервисная служба

Name • Nom • Nome • Naam • Nazwa • Jméno • Názov • Név • Denumire • Isim • Название		
Nr. • No. • N° • Номер • Číslo • Sz		
Тур • Type • Típus • Tipus • Típo • Тип		

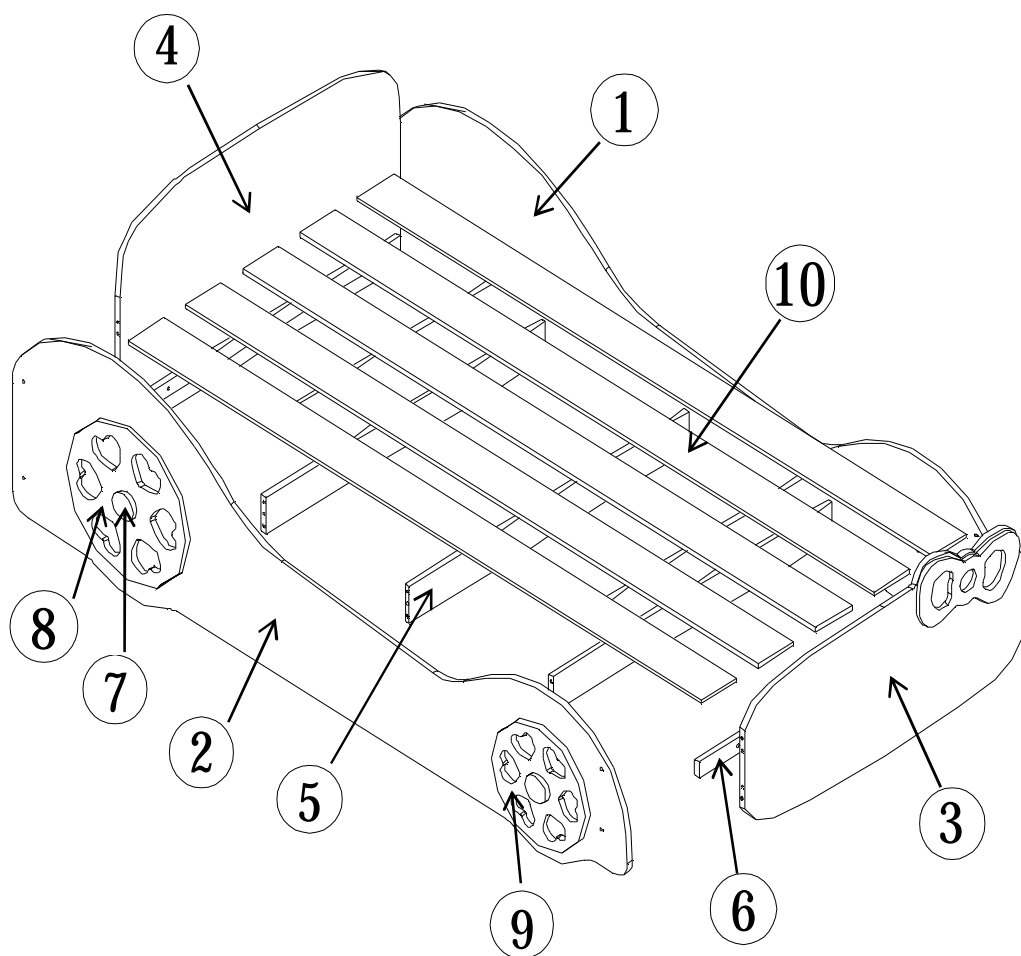

- |                   |                    |                   |                  |                  |                  |
|-------------------|--------------------|-------------------|------------------|------------------|------------------|
| <b>A</b> x6       | <b>B</b> x6        | <b>C</b> 8x30 x20 | <b>D</b> 6x25 x6 | <b>E</b> 6x35 x4 | <b>F</b> 6x50 x8 |
| <b>G</b> 10x11 x8 | <b>H</b> 3.5x29 x8 | <b>I</b> x4       |                  |                  |                  |

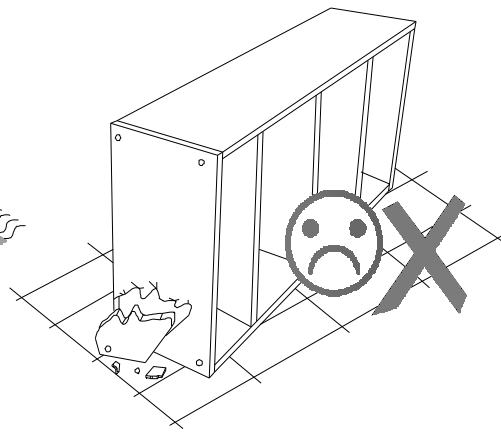
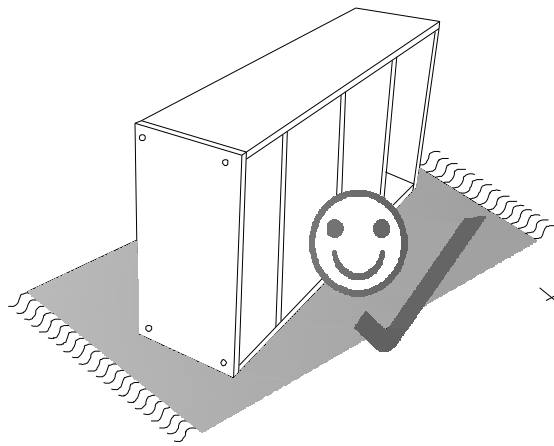

1

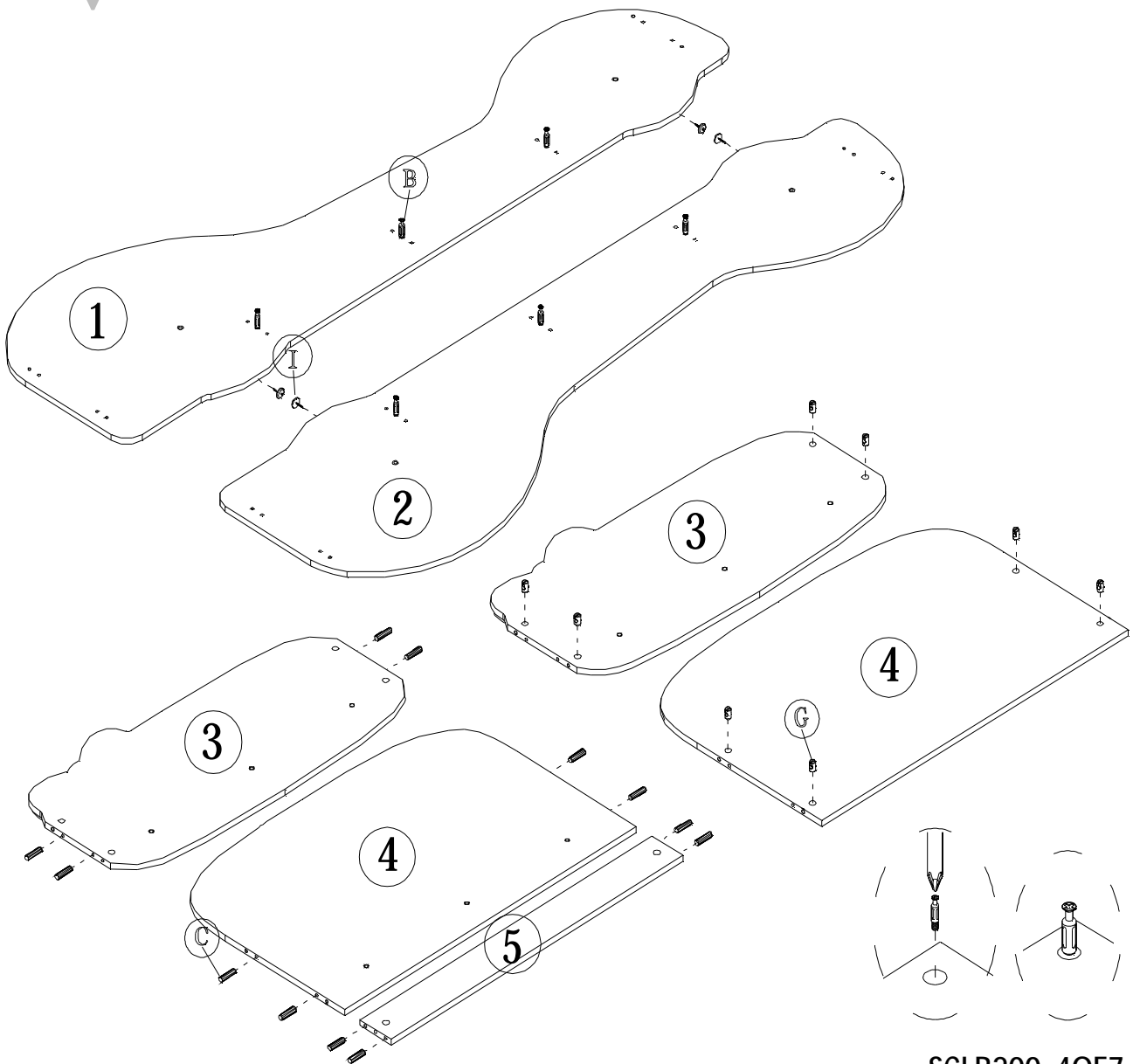
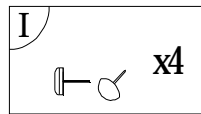
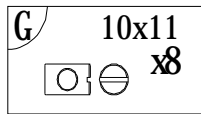
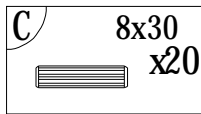
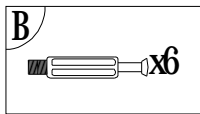

SCLB200 40F7  
Ver1.013

2

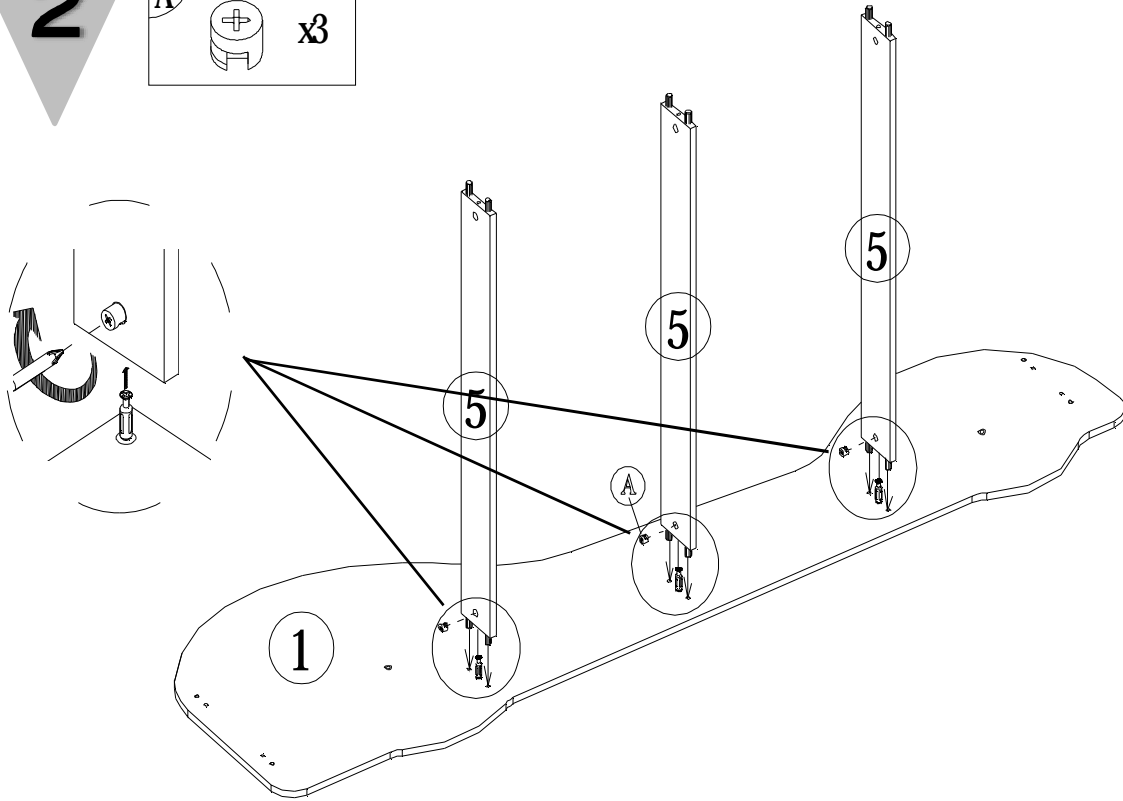
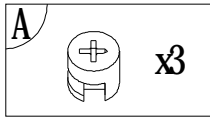

3

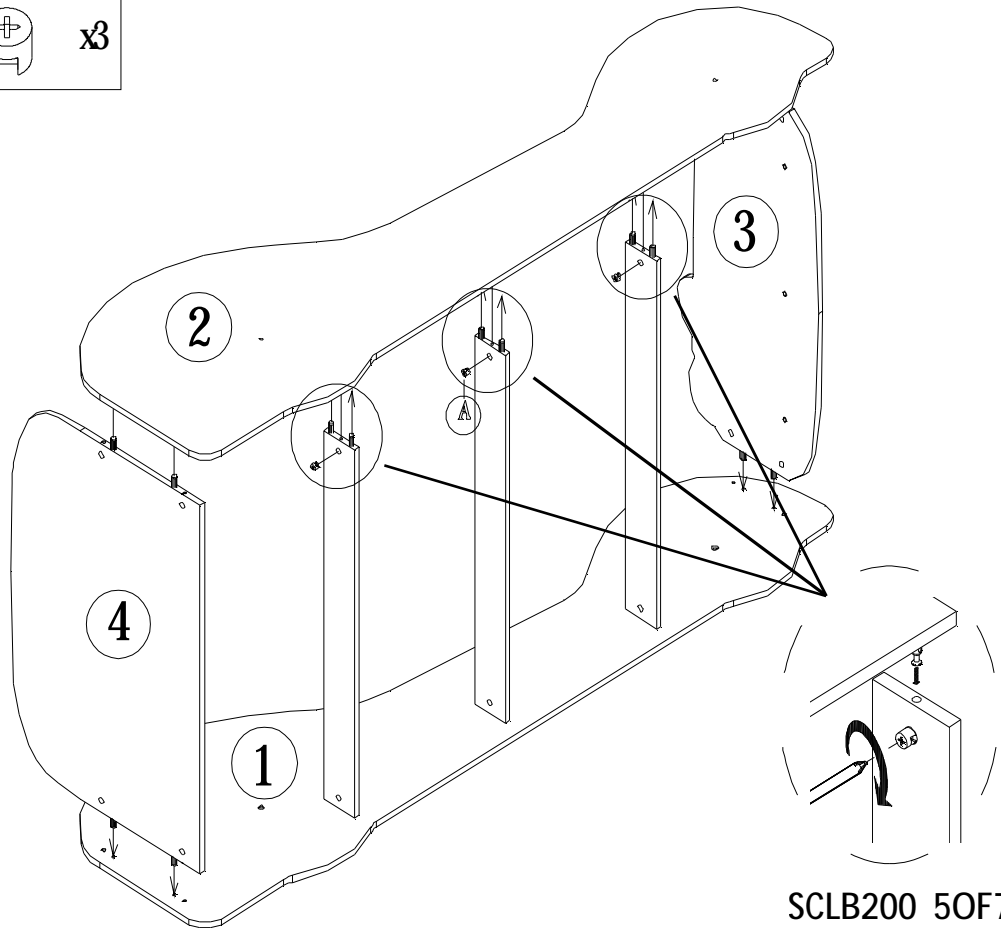
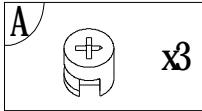

4

D 6x25  
x6

F 6x50  
x8

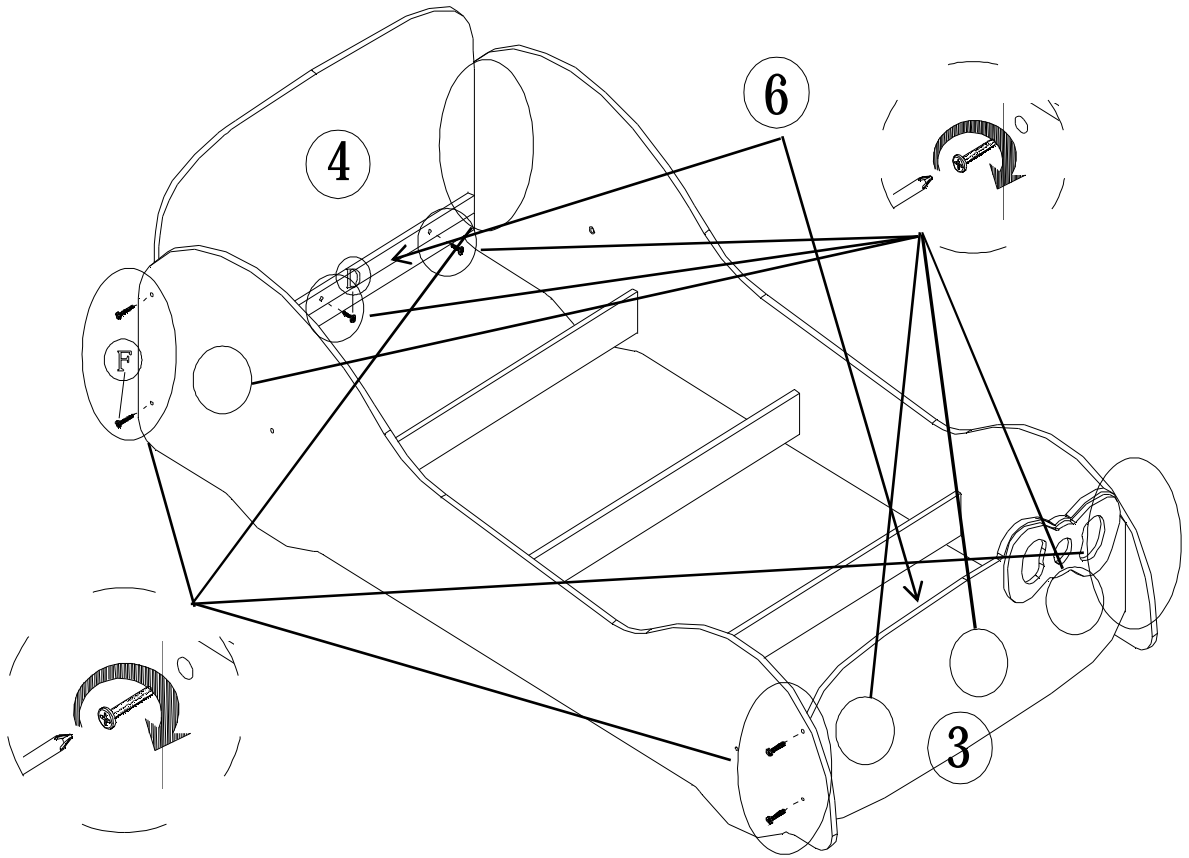

5

E 6x35  
x4

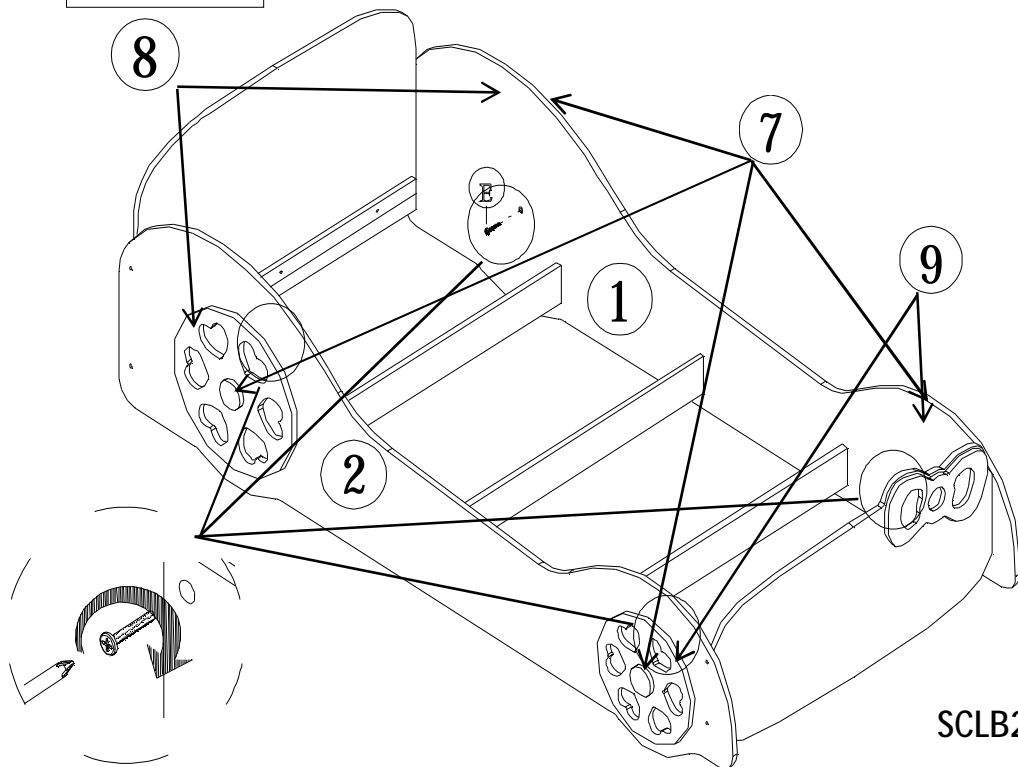

6

H 3.5x29  
x8

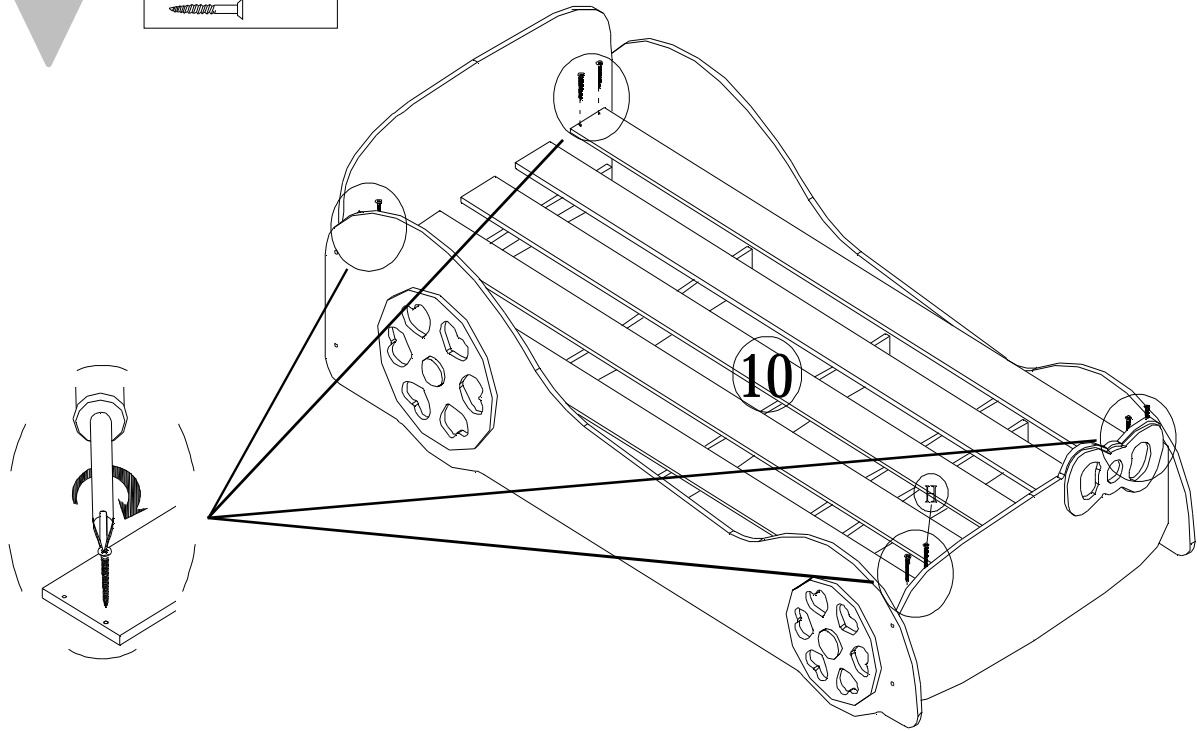

7

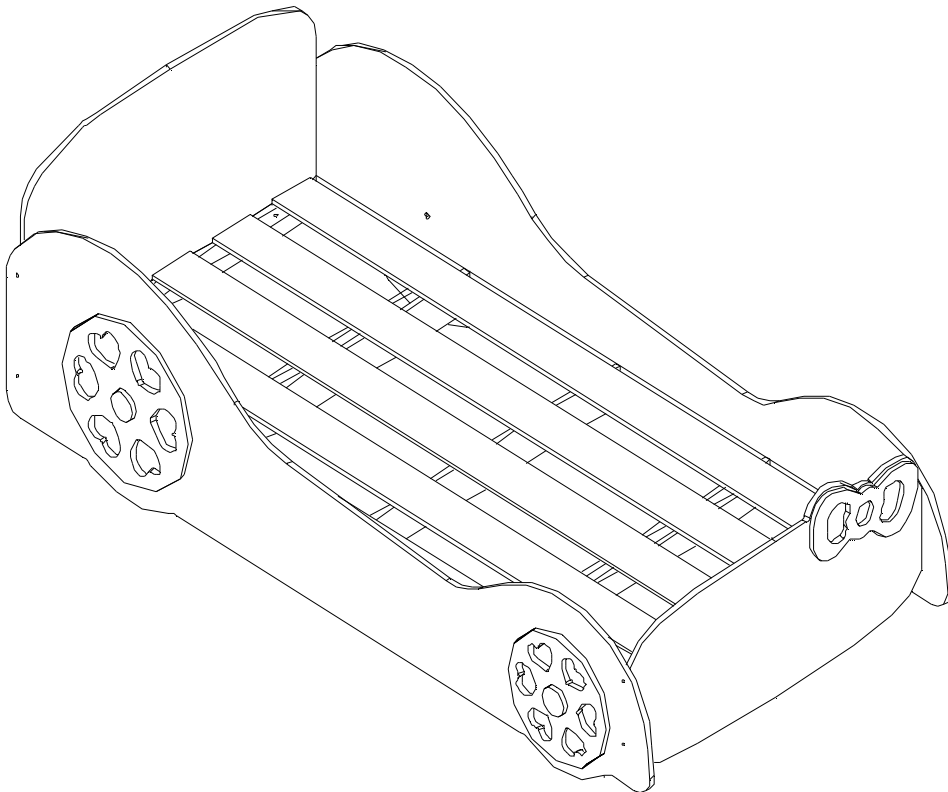

SCLB200 7OF7  
Ver1.013