

Monitor Mount - Wall Mountable with Full-Motion Articulating Arm

ARMPiVWALL



*actual product may vary from photos

FR: Guide de l'utilisateur - fr.startech.com
DE: Bedienungsanleitung - de.startech.com
ES: Guía del usuario - es.startech.com
NL: Gebruiksaanwijzing - nl.startech.com
PT: Guia do usuário - pt.startech.com
IT: Guida per l'uso - it.startech.com
UK: User guide - uk.startech.com

For the latest information, technical specifications, and support for this product, please visit www.StarTech.com/ARMPiVWALL.

Warning statements

Make sure to assemble this product according to the instructions. Failure to do so might result in personal injury or property damage.

Make sure that the weight of the monitor doesn't exceed the weight capacity of this product. If you exceed the weight capacity, you might experience personal injury or damage to the equipment. This product can support the following weight: 4.4 lb. (2 kg) to 19.8 lb. (9 kg).

Never operate this product if parts are missing or damaged.

Always any part of your component cables to get caught between moveable parts might result in personal injury or damage to your equipment. Make sure that you leave enough cable slack at the arm joints so that the arm can be fully extended.

Before you remove the monitor, make sure that the spring arm is in the full upright position. When you remove the monitor from the spring arm, the arm will spring upward.

Wall structures vary, and it's important to make sure that the type of wall structure and mounting hardware that you're using will properly support the mounted equipment. Failure to do so may result in personal injury or equipment damage. The wall structure should be capable of supporting at least four times the weight of the mounted equipment.

The mounting hardware included with this product might not be adequate for some wall structures. If you lack the necessary expertise to attach this product to the wall structure that you're using, contact a construction professional to install the wall mount or to provide specific mounting instructions for your wall structure.

Dichiarazioni di avvertenza

Assemblare il prodotto rispettando le istruzioni. Il mancato rispetto delle istruzioni potrebbe causare danni a persone o proprietà.

Verificare che il peso del monitor non superi la capacità di supporto del prodotto. In caso di superamento della capacità di supporto potrebbero verificarsi danni a persone o apparecchiature. Il prodotto è in grado di supportare i seguenti pesi: da 2 kg a 9 kg.

Non utilizzare il prodotto in presenza di parti mancanti o danneggiate.

L'eventuale intrappolamento dei cavi del componente fra elementi in movimento potrebbe causare danni a persone o apparecchiature. Lasciare spazio a sufficienza presso i giunti del braccio in modo da poterlo estendere in maniera completa.

Prima di rimuovere il monitor, verificare che il braccio a molle si trovi in posizione completamente eretta. Al momento di rimuovere il monitor dal braccio a molle, il braccio scatterà verso l'alto.

Le caratteristiche dei muri sono variabili ed è importante verificare che la struttura muraria e l'hardware di montaggio in uso siano in grado di supportare adeguatamente le apparecchiature montate. Il mancato rispetto delle istruzioni potrebbe causare danni a persone o proprietà. La struttura muraria deve essere in grado di supportare un peso almeno quattro volte superiore a quello dell'apparecchiatura montata.

L'hardware di montaggio incluso con il prodotto potrebbe non essere adeguato ad alcune strutture murarie. Se l'utente non dispone delle competenze necessarie per agganciare il prodotto alla struttura muraria in uso, dovrà contattare un professionista edile per installare il supporto a parete o ottenere istruzioni di montaggio per la struttura muraria in uso.

Avertissements

Assemblez ce produit conformément aux instructions. Si vous ne respectez pas ces instructions, vous risquez de vous blesser ou d'endommager l'équipement.

Verifiez que le poids du monitor ne dépasse pas la capacité pondérale du produit. Si vous dépassez la capacité pondérale, vous risquez de blessures corporelles ou des dommages matériels. Ce produit peut supporter de 2 kg à 9 kg.

N'utilisez pas ce produit si des pièces sont endommagées ou manquantes.

Si les câbles des composants se coincent entre des parties mobiles, vous risquez de blesser corporelles ou de dommages matériels. Vérifiez que les câbles sont suffisamment lâches au niveau des joints du bras afin que le bras puisse être complètement déplié.

Avant de retirer le moniteur, vérifiez que le bras à ressort est en position verticale. Lorsque vous retirez le moniteur du bras à ressort, le bras se tend brusquement vers le haut.

Les structures des murs varient. Vous devez impérativement vérifier que le type de mur et le matériel de fixation que vous utilisez permettent de soutenir correctement l'équipement. Dans le cas contraire, vous risquez de blessures corporelles ou de dommages matériels. La structure du mur doit pouvoir supporter au moins quatre fois le poids de l'équipement monté.

Le matériel de fixation inclus avec ce produit n'est pas forcément approprié pour toutes les structures de murs. Si l'utilisateur ne dispose pas des compétences nécessaires pour agencer le produit au mur, contactez un professionnel afin qu'il installe le support mural ou qu'il vous fournisse les instructions de montage spécifiques à votre structure de mur.

Warnhinweise

Montieren Sie dieses Produkt gemäß den Anweisungen. Andernfalls kann dies zu Verletzungen von Personen oder Schäden an Eigentümern führen.

Das Gewicht des Monitors darf die zulässige Traglast des Produkts nicht überschreiten. Wenn die Traglast überschritten wird, kann dies zu Verletzungen von Personen oder Schäden an Geräten führen. Dieses Produkt ist für folgendes Gewicht geeignet: 2 kg bis 9 kg.

Das Produkt darf nicht bedient werden, wenn Teile fehlen oder beschädigt sind.

Wenn sich Komponentenablagern in beweglichen Teilen verfangen, kann dies zu Verletzungen von Personen oder Schäden an Geräten führen. An Gelenken muss ausreichend Kabellänge vorhanden sein, damit der Arm vollständig gestreckt werden kann.

Bevor Sie den Monitor entfernen, muss der Federarm vollständig aufrecht gestellt werden. Wenn Sie den Monitor vom Federarm entfernen, springt der Arm nach oben.

Wandstrukturen unterscheiden sich, und es muss sichergestellt werden, dass die Wand und das verwendete Montagematerial das montierte Gerät halten kann. Andernfalls kann dies zu Verletzungen von Personen und/oder Schäden an Geräten führen. Die Wand muss mindestens das Vierfache des Gewichts des montierten Geräts halten können.

Das mitgelieferte Montagematerial ist möglicherweise nicht für jede Wand geeignet. Wenn Ihnen die nötigen Fachkenntnisse zum Anbringen dieses Produkts an einer Wand fehlen, lassen Sie einem Fachmann den Montageort anbringen, oder lassen Sie sich von einem Fachmann Montageanweisungen für Ihre Wand erteilen.

Waarschuwingen

Zorg dat dit product volgens de instructies in elkaar wordt gezet. Indien dit niet goed gebeurt kan lichamelijk letsel of materiële schade ontstaan.

Zorg dat het gewicht van het scherm de maximale capaciteit van dit product niet overschrijdt. Als u de gewichtscapaciteit overschrijdt, kan persoonlijk letsel of schade aan de apparatuur ontstaan. Dit product ondersteunt het volgende gewicht: 2 kg tot 9 kg.

Gebruik dit product nooit als er onderdelen ontbreken of beschadigd zijn.

Als uw componentkabels tussen bewegende delen vast komen te zitten, kan dit lichamelijk letsel of schade aan de apparatuur veroorzaken. Zorg dat de kabels voldoende speling bij de armgewrichten hebben zodat de arm volledig kan worden uitgestrekt.

Indien u de monitor wilt verwijderen, zorg er dan voor dat de veerarm helemaal rechtop staat, anders zal de arm omhoog springen.

Omdat wanden verschillen, is het belangrijk dat u ervoor zorgt dat het type wandstructuur en de montagemiddelen die u gebruikt de gemonteerde apparatuur goed ondersteunen. Indien u dit niet doet kan lichamelijk letsel en/of schade aan de apparatuur ontstaan. De wandstructuur moet voldoende zijn om ten minste vier keer het gewicht van de gemonteerde apparatuur te ondersteunen.

De bij dit product geleverde montagemiddelen kunnen niet geschikt zijn voor sommige wandstructuren. Als u onvoldoende kennis hebt om dit product aan de deur of te gebruiken wandstructuur te bevestigen, neem dan contact op met een bouwkundige om de steun aan de muur te installeren of specifieke montage-instructies voor uw wandstructuur te geven.

Varningsmeddelanden

Se till att du monterar produkten i enlighet med instruktionerna. Om du inte gör det kan skada på person eller egendom uppstå.

Se till att skärmens vikt inte överstiger produktens viktkapacitet. Om viktkapaciteten överstigs kan skada på person eller utrustning uppstå. Denna produkt har stöd för följande vikter: 2 kg till 9 kg.

Använd aldrig produkten om delar saknas eller är skadade.

Om någon del av dina komponentkabelar fastnar mellan rörliga delar kan skada på person eller utrustning uppstå. Se till att det finns tillräckligt med kabel vid armbrederna så att armen kan sträckas ut helt.

Se till att fjäderarmen är i full upprätt position innan du tar bort skärmen. När du tar bort skärmen från fjäderarmen kommer armen att springa uppåt.

Eftersom väggstruktur varierar är det viktigt att kontrollera att väggstrukturen och monteringsutrustningen som du använder klarar av den monterade utrustningen. Om du inte gör det kan skada på person och/eller utrustning uppstå. Väggstrukturen ska kunna klara av minst fyra gånger vikten av den monterade utrustningen.

Monteringsutrustningen som medföljer produkten kanske inte är lämplig för vissa väggstrukturer. Om du saknar nödvändiga kunskaper för att fästa denna produkt på väggstrukturen som du använder, kontakta en professionell konstruktör för att installera väggmonteringen eller för att ge specifika monteringsinstruktioner för din väggstruktur.

Mensagens de aviso

Certifique-se de que monta este produto de acordo com as instruções. O incumprimento pode resultar em ferimentos pessoais ou danos de propriedade.

Certifique-se de que o peso do monitor não excede a capacidade de peso deste produto. Se exceder a capacidade de peso, pode sofrer ferimentos pessoais ou danos ao equipamento. Este produto pode suportar o seguinte peso: 2 kg a 9 kg.

Nunca opere este produto se faltarem peças ou estas estiverem danificadas.

Não permita que qualquer parte dos cabos do seu componente fique preso entre móveis, pode resultar em ferimentos pessoais ou danos ao seu equipamento. Certifique-se de que deixa uma folga suficiente no cabo nas juntas do braço de forma a que o braço possa ser totalmente expandido.

Antes de retirar o monitor, certifique-se de que o braço de mola está totalmente na vertical. Quando retirar o monitor do braço de mola, o braço irá saltar para cima.

As estruturas de parede variam e é importante certificar-se de que o tipo de estrutura de parede e hardware de montagem que está a usar suporta adequadamente o equipamento montado. O incumprimento pode resultar em ferimentos pessoais e/ou danos ao equipamento. A estrutura de parede deve ser capaz de suportar pelo menos quatro vezes o peso do equipamento montado.

O hardware de montagem incluído com este produto pode não ser adequado para algumas estruturas de parede. Se o utilizador não tiver o conhecimento necessário para fixar este produto à estrutura de parede que está a usar, contacte um profissional de construção para fazer a instalação em parede ou para fornecer instruções de montagem específicas para a sua estrutura de parede.

Advertencias

Asegúrese de ensamblar este producto según las instrucciones. De lo contrario, pueden producirse lesiones personales o daños en la propiedad.

Asegúrese de que el peso del monitor no excede la capacidad de peso de este producto. Si se excede la capacidad del peso podría producirse lesiones personales o daños del equipo. Este producto tiene capacidad para el siguiente peso: de 2 a 9 kilogramos.

Nunca opere o ponga en funcionamiento este producto si faltan piezas o están dañadas.

En caso de que sus cables queden atrapados en piezas en movimiento se pueden producir lesiones personales o daños del equipo. Asegúrese de dejar suficiente espacio para movimiento de los cables en las articulaciones, a fin de que el brazo quede totalmente extendido.

Antes de retirar el monitor del brazo con muelle, el brazo saltará hacia arriba.

Las estructuras de las paredes pueden variar y, por tanto, es importante determinar con certeza el tipo de estructura de la pared y el hardware de montaje que se va a utilizar para soportar debidamente el equipo. De lo contrario, se pueden producir lesiones personales o daños del equipo. La estructura de la pared debe ser capaz de soportar al menos cuatro veces el peso del equipo instalado.

El hardware de montaje incluido con este producto puede no ser adecuado para algunas estructuras de paredes. Si el usuario no tiene la experiencia suficiente para fijar este producto a la estructura de la pared correspondiente, póngase en contacto con un profesional de la construcción para instalar el soporte para pared o para que le proporcione las instrucciones específicas de montaje para su estructura de pared.

Table of Contents

Warning statements	i
Introduction	1
Product diagrams	1
Technical specifications	3
Package contents	4
System requirements	5
Installation	5
Attach the wall plate to the wall	5
Attach the spring arm to the wall plate	6
Attach a monitor to the spring arm	7
Route the cables	8
Adjust the tension of the monitor mount	9
Adjust the tension of the spring arm	9
Technical support	11
Warranty information	11

Introduction





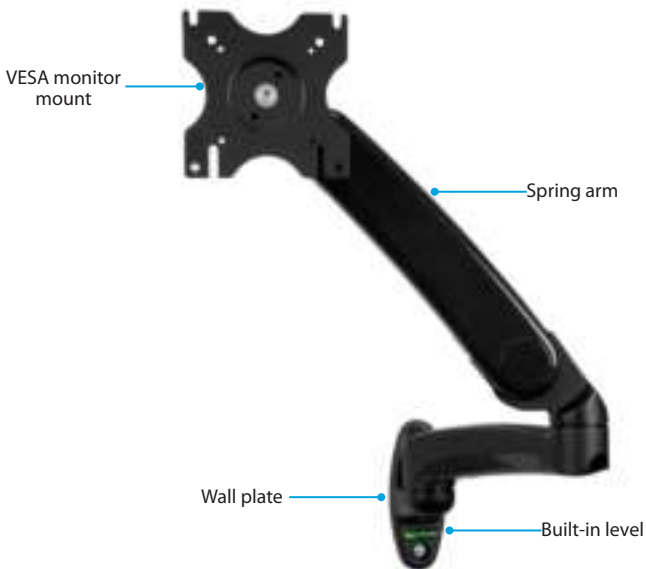

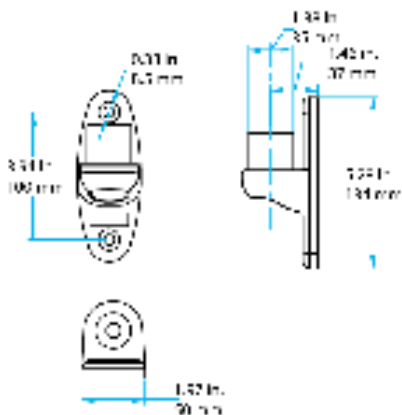
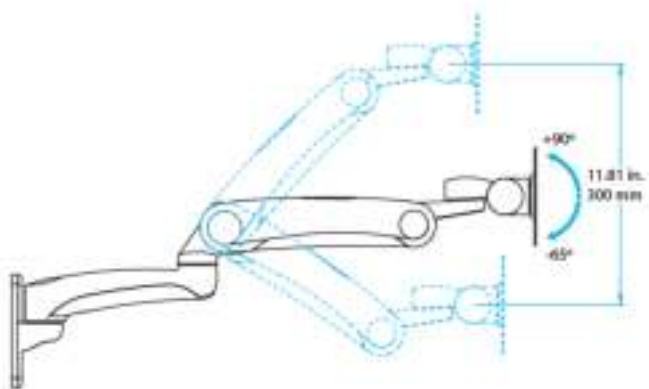
You can use the ARMPIVWALL to mount your monitor and save space at your desk. Unlike other wall mounts, the ARMPIVWALL can be moved so that it's at the ideal height and distance for you. The ARMPIVWALL comes with cable management to avoid unsightly cable clutter. You can tilt and twist the monitor mount and position the monitor in both landscape and portrait directions.

Product diagrams





Technical specifications

Type of measurement	Measurement
Supported weight 	Between 4.4 and 19.8 lb. (2 and 9 kg)
Pivot 	360°
Swivel 	180°
Tilt 	-65° to +90°
Maximum extension 	620 mm
VESA hole pattern 	75x75 mm 100x100 mm

Package contents

1



Spring arm
Qty: One

2



Cover
Qty: One

3



Wall plate
Qty: One

4



M5 Allen key
Qty: One

5



M6 screw
Qty: One

6



6.3 x 65 mm screws
Qty: Two

7



M4x12 mm screws
Qty: Four

8



M4x25 mm screws
Qty: Four

9



Anchors
Qty: Two

10



Washers
Qty: Two

11



Spacers
Qty: Four

12



Zip tie
Qty: One

13



Instruction manual
Qty: One

System requirements

- Phillips screwdriver

System requirements are subject to change. For the latest requirements, please visit www.StarTech.com/ARMPiVWALL.

Installation

 **Warning!** Make sure that the weight of the monitor doesn't exceed the weight capacity of this product. If you exceed the weight capacity, you might experience personal injury or damage to the product. This product can support the following weight: 4.4 lb. (2 kg) to 19.8 lb. (9 kg).

Attach the wall plate to the wall

 **Warning!** Wall structures vary, and it's important to make sure that the type of wall structure and mounting hardware that you're using will properly support the mounted equipment. Failure to do so may result in personal injury and/or equipment damage. The wall structure should be capable of supporting at least four times the weight of the mounted equipment.

 **Warning!** The mounting hardware included with this product might not be adequate for some wall structures. If you lack the necessary expertise to attach this product to the wall structure that you're using, contact a construction professional to install the wall mount or to provide specific mounting instructions for your wall structure.

1. Use a pencil to mark the location on the wall where you want to attach the wall plate.
- Tip!** Use the built-in level on the wall plate to make sure that the wall plate is level.
2. Follow the appropriate steps for the type of wall that you're attaching the mount to and attach the wall plate to the wall.

Attach the spring arm to the wall plate

1. Slide the spring arm (1) onto the wall plate (3).
2. Insert the M6 screw (5) through the bottom of the wall plate and into the spring arm.
3. Push the cover (2) onto the spring arm where it's attached to the wall plate. (*figure 1*)
4. Use the M5 Allen key (4) to tighten the hex screw. (*figure 2*)

figure 1

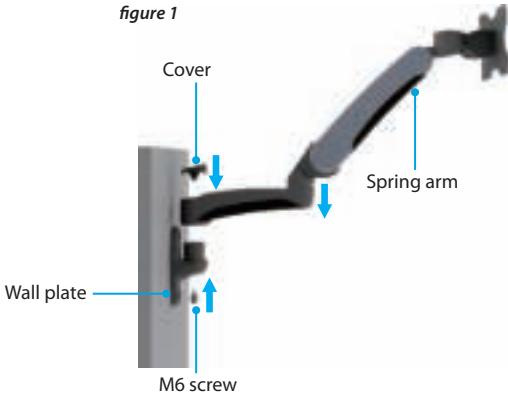



figure 2



Attach a monitor to the spring arm

Caution! To prevent scratching, you should handle the surface of the monitor with care when you attach it to the spring arm.

 **Warning!** Make sure that the weight of the monitor doesn't exceed the weight capacity of this product. If you exceed the weight capacity, you might experience personal injury or damage to the product. This product can support the following weight: 4.4 lb. (2 kg) to 19.8 lb. (9 kg).

1. Do one of the following:

- If the VESA mount sits flush against the installation surface on the monitor, insert the four M4x12 mm screws (7) through the VESA mount on the spring arm (1) and into the mounting holes on the back of the monitor. Use a Phillips screwdriver to tighten the screws. (*figure 3*)
- If the VESA mount doesn't sit flush against the installation surface on the monitor, you need to use the provided spacers. Insert the four M4x25 mm screws (8) through the VESA mount on the spring arm (1), into the four spacers (11), and into the mounting holes on the back of the monitor. Use a Phillips screwdriver to tighten the screws. (*figure 4*)

figure 3

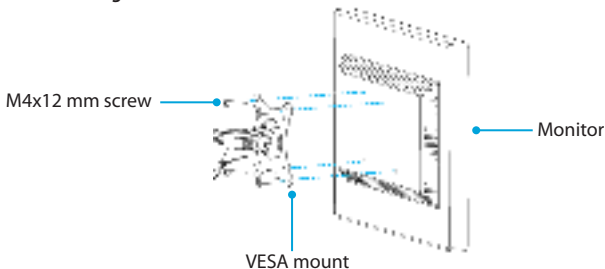
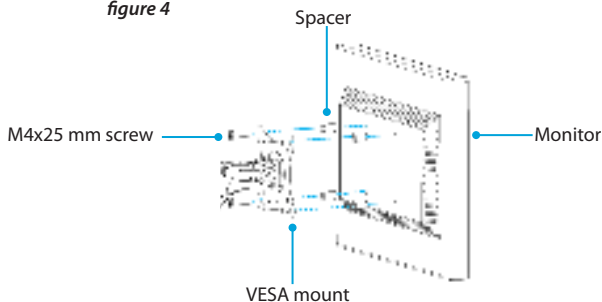



figure 4



Route the cables

 **Warning!** Allowing any part of your computer cables to get caught between moveable parts might result in personal injury or damage to your equipment. Make sure that you leave enough cable slack at the arm joints so that the arm can be fully extended.

1. Remove the cable covers from the spring arm (1).
2. Run the cables down the spring arms, leaving enough slack at the arm joints.
3. While holding the cables against the spring arms, press the cable covers back onto the spring arm. (figure 5)

figure 5

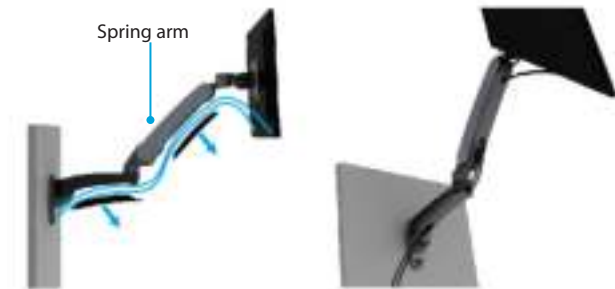

Adjust the tension of the monitor mount

If the monitor doesn't stay in the position that you put it in or you can't tilt the monitor at all, you may need to adjust the tension of the monitor mount.

- To reduce the tilt tension, use the M5 Allen key (4) to move the screw in the VESA monitor mount counterclockwise. (*figure 6*)
- To increase the tilt tension, use the M5 Allen key (4) to move the screw in the VESA monitor mount clockwise. (*figure 6*)

figure 6

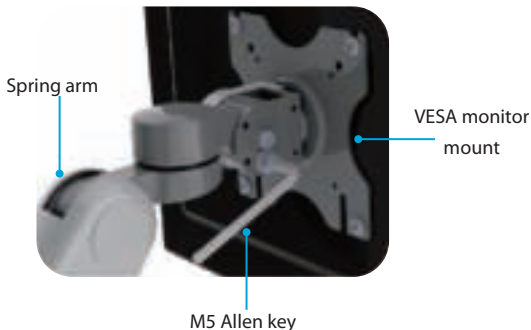



Adjust the tension of the spring arm

If the spring arm doesn't stay in the position that you put it in or you can't move the spring arm at all, you may need to adjust the tension.

- To increase the tension of the spring arm, use the M5 Allen key (4) to move the screw in the spring arm (1) counterclockwise. (*figure 7*)
- To decrease the tension of the spring arm, use the M5 Allen key (4) to move the screw in the spring arm (1) clockwise. (*figure 7*)

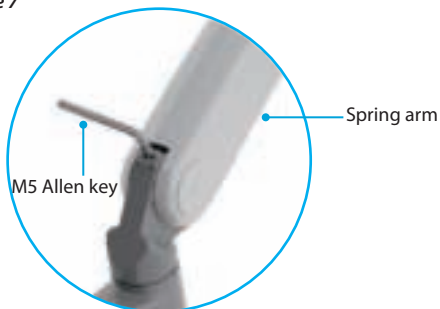
figure 7



 Before you remove the monitor, make sure that the spring arm is in the full upright position. When you remove the monitor from the spring arm, the arm will spring upward.

Technical support

StarTech.com's lifetime technical support is an integral part of our commitment to provide industry-leading solutions. If you ever need help with your product, visit www.startech.com/support and access our comprehensive selection of online tools, documentation, and downloads.

For the latest drivers/software, please visit www.startech.com/downloads

Warranty information

This product is backed by a five-year warranty.

StarTech.com warrants its products against defects in materials and workmanship for the periods noted, following the initial date of purchase. During this period, the products may be returned for repair, or replacement with equivalent products at our discretion. The warranty covers parts and labor costs only. StarTech.com does not warrant its products from defects or damages arising from misuse, abuse, alteration, or normal wear and tear.

Limitation of Liability

In no event shall the liability of StarTech.com Ltd. and StarTech.com USA LLP (or their officers, directors, employees or agents) for any damages (whether direct or indirect, special, punitive, incidental, consequential, or otherwise), loss of profits, loss of business, or any pecuniary loss, arising out of or related to the use of the product exceed the actual price paid for the product. Some states do not allow the exclusion or limitation of incidental or consequential damages. If such laws apply, the limitations or exclusions contained in this statement may not apply to you.

Use of Trademarks, Registered Trademarks, and other Protected Names and Symbols

This manual may make reference to trademarks, registered trademarks, and other protected names and/or symbols of third-party companies not related in any way to StarTech.com. Where they occur these references are for illustrative purposes only and do not represent an endorsement of a product or service by StarTech.com, or an endorsement of the product(s) to which this manual applies by the third-party company in question. Regardless of any direct acknowledgement elsewhere in the body of this document, StarTech.com hereby acknowledges that all trademarks, registered trademarks, service marks, and other protected names and/or symbols contained in this manual and related documents are the property of their respective holders.

Hard-to-find made easy. At StarTech.com, that isn't a slogan. It's a promise.

StarTech.com is your one-stop source for every connectivity part you need. From the latest technology to legacy products — and all the parts that bridge the old and new — we can help you find the parts that connect your solutions.

We make it easy to locate the parts, and we quickly deliver them wherever they need to go. Just talk to one of our tech advisors or visit our website. You'll be connected to the products you need in no time.

Visit www.startech.com for complete information on all StarTech.com products and to access exclusive resources and time-saving tools.

StarTech.com is an ISO 9001 Registered manufacturer of connectivity and technology parts. StarTech.com was founded in 1985 and has operations in the United States, Canada, the United Kingdom and Taiwan servicing a worldwide market.