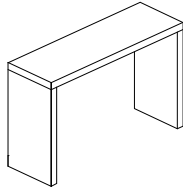

Diagram illustrating assembly steps and safety warnings:

- Step 1:** A box containing an L-shaped corner bracket. A warning triangle with an exclamation mark is positioned to the right.
- Step 2:** A box containing a rectangular block being placed on a surface. A warning triangle with an exclamation mark is positioned to the right.
- Time:** A clock icon with the text "15'" below it, indicating a 15-minute assembly time.
- Person:** A stick figure icon with the text "1" below it, indicating that one person is required for assembly.

1



x 1

2

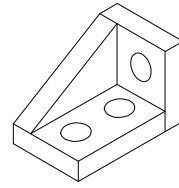

x 2

A

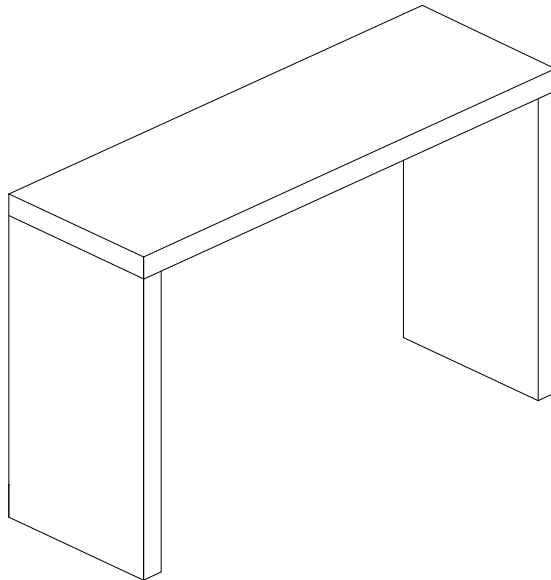

A



x 1

B

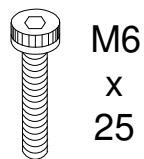

M6
x
25

x 6

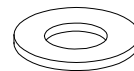

C



x 6

2/3

1

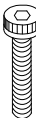
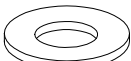
<p>1</p>  <p>x 1</p>	<p>2</p>  <p>x 2</p>	<p>A</p>  <p>x 1</p>	<p>B</p>  <p>M6 x 25</p> <p>x 6</p>	<p>C</p>  <p>x 6</p>
---	---	---	--	---

