

# INSTRUCTION MANUAL

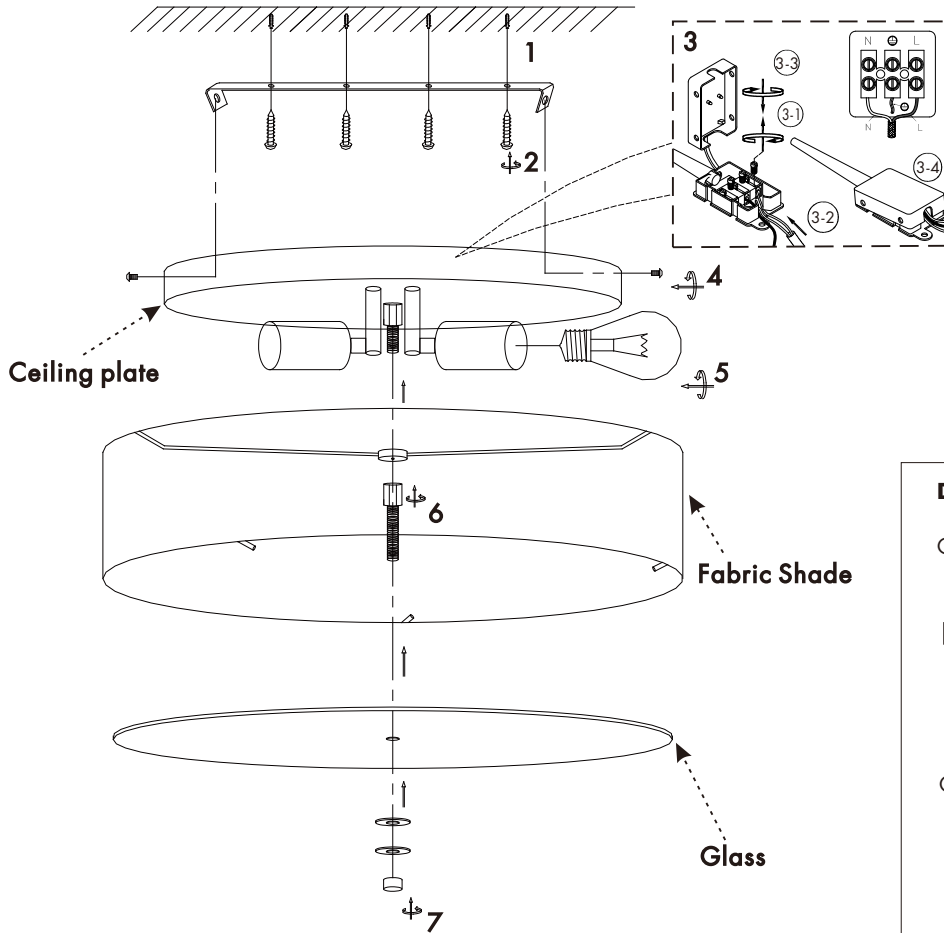

## Drum CL



### Drum CL 35 Square

Ceiling plate: 2xE27

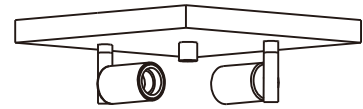

Overall size:

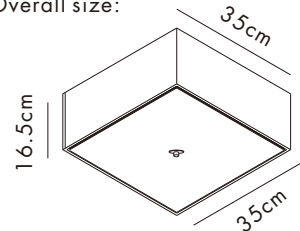

### Drum CL 30

Ceiling plate: 2xE27

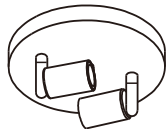

Overall size:

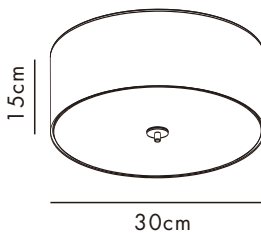

### Drum CL 50

Ceiling plate: 4xE27

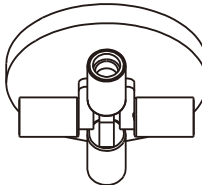

Overall size:

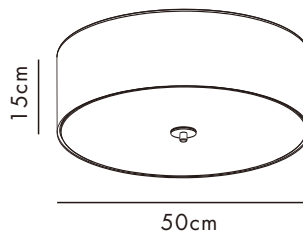

### Drum CL 70

Ceiling plate: 6xE27

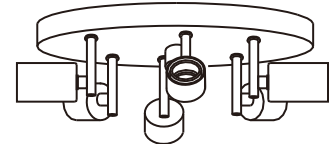

Overall size:

