



# Architecture

## Louvre

Paris, France

### 21024

- 🇬🇧 Booklet available in English on
- 🇩🇪 Heft in deutscher Sprache erhältlich auf
- 🇫🇷 Livret disponible en français sur
- 🇪🇸 Folleto disponible en español en
- 🇵🇹 Folheto disponível em português em
- 🇭🇺 A füzet magyarul ezen a honlapon olvasható
- 🇮🇹 Libretto disponibile in italiano su
- 🇨🇳 如需中文版手册，请访问



[LEGO.com/architecture](https://www.lego.com/architecture)





## The Louvre

The Louvre, in its many different forms, has dominated the city of Paris since the late 12th century. Today it is the most visited museum in the world, renowned for famous works of art such as da Vinci's *Mona Lisa*, as well as the building's spectacular Renaissance to Modernist architecture.



© Musée du Louvre, Dist RMN/ Olivier Ouadah



Pyramide du Louvre: original work of I.M. Pei  
© Musée du Louvre, Dist RMN/ Phodia



Pyramide du Louvre - original work of I.M. Pei © Musée du Louvre, Dst R/W/Oliver Ouédah

# History

## *From Fortress to Museum*

The original Louvre was a fortress built in the late 12th century to protect the city of Paris. Located on the western edge of the city, the structure was gradually engulfed as Paris grew. The dark fortress from the Middle Ages was continually altered and expanded, before being transformed into a Renaissance style royal palace from 1546 onwards.

When Louis XIV moved his royal court from the Louvre to the recently enlarged Palace of Versailles in 1678, much of the royal art collection remained at the Louvre. A number of national cultural institutions and scholarly societies moved into the Louvre, which also became a residence for artists. In 1699, the Académie Royale de Peinture et de Sculpture (Royal Academy of Painting and Sculpture) held its first public exhibition in the building's Grande Galerie (Great Gallery).

The transformation of the Louvre into the museum we know today began with the French Revolution. In 1791 the new National Assembly declared that the Louvre should be “a place for bringing together monuments of all the sciences and arts”, and when Louis XVI was arrested in 1792, his royal art collection became national property. The Louvre Museum officially opened a year later, giving free public access to a collection that

included works by da Vinci, Raphael, Poussin and Rembrandt.

Throughout the next 200 years, the Louvre would witness the restoration and abolishment of the French monarchy, the Napoleonic era, plus the establishment of five new French Republics. The museum's collection increased throughout this turbulent period and by the early 1980s, it was clear that a major renovation was needed to improve the displays and provide better amenities for the increasing number of visitors.



© Musée du Louvre, Dist. RMN/ Olivier Ouadah

# Renovation

## *When New Met Old*

When President François Mitterrand came to power in 1981, he launched an ambitious program to create a series of modern architectural monuments in Paris that would symbolize France's role in art, politics, and economy. The best known of these Grands Projets (Grand Projects) would be the redesign and expansion of the Louvre.

The committee in charge of overseeing the project visited museums in Europe and the United States, and were particularly impressed with the East Building of the National Gallery of Art in Washington. Its architect, I. M. Pei, was invited to Paris and asked to lead the comprehensive renovation project.

The biggest challenge Pei faced was the lack of space. The physical layout of the Louvre had remained the same since 1874: two wings attached to the oldest museum building, forming a rectangular structure around the Cour Napoléon plaza.

Pei's solution was to hollow out the central courtyard, place the main entrance in its center and construct a series of underground connections to the various wings. Visitors would descend into a spacious lobby and quickly access the main Louvre buildings. At

the same time he also proposed reorganizing and redistributing the collection, as well as covering several smaller courtyards to create more display space. However, Pei's proposal for a glass and steel pyramid to cover the new entrance would cause great controversy. To Pei, the shape not only provided the new lobby with the best natural light, it was 'the most compatible with the architecture of the Louvre'. Many disagreed, with one opponent describing the proposed pyramid as a 'gigantic, ruinous gadget'.

The criticism eased somewhat after Pei placed a full-sized model of the pyramid in the courtyard. The new entrance, with its famous pyramid, was inaugurated in March 1989 and became an instant architectural icon for the whole of the newly renovated Louvre Museum.



© EPGL, Patrice Astier 1987

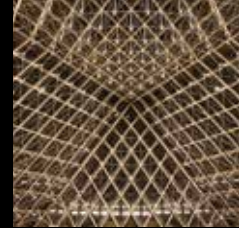

Pyramide du Louvre: original work of I.M. Pei © Musée du Louvre, Dist RMN/ Antoine Mongodin

## The Louvre Today



© Musée du Louvre, Dist RMN/ Franck Bohbot

The renovation of the Louvre was completed in 1993 and proved a great success, with the number of visitors to the museum doubling within the first year. With an area of 60,600 m<sup>2</sup> (652,300 sq ft) and over 400,000 works of art in its collection, it remains one of the largest and most impressive museums in the world. With close to 10 million visitors each year, the Louvre has also become the world's most visited museum.

*[ It signifies a break with the architectural traditions of the past.*

*It is a work of our time. ]*

I. M. Pei



Pyramide du Louvre: original work of J.M. Pei © Musée du Louvre, Dst. RMN/ Stéphane Olivier

# The Architect

## *Ieoh Ming Pei*

Ieoh Ming Pei was born in China in 1917 and travelled to the USA at the age of 17 to study architecture at the Massachusetts Institute of Technology (MIT). Inspired by the work of Le Corbusier and the new International Style of architecture, he continued to Harvard's Graduate School of Design, where he met Walter Gropius and Marcel Breuer, two leaders of the European Bauhaus movement.

In 1955, after working for the New York firm of Webb & Knapp on a variety of large-scale structures across the USA, Pei established his own firm, I. M. Pei and Associates. Pei and his team worked on a number of major projects, including the Kennedy Library in Boston, Dallas City Hall in Texas and the new East Building of

Washington's National Gallery of Art. It was this last building that would bring him to the attention of those in charge of the Louvre renovation project.

Pei would be the first foreign architect to work on the Louvre, and many in France were skeptical that such a prestigious national project had been given to an architect with a reputation as the 'master of modern architecture'. He himself was acutely aware that 'the history of Paris was embedded in the stones of the Louvre'. Though his suggestions — not least the glass pyramid — initially received much criticism, the renovation was a great success and the Louvre's pyramid would become his most famous structure.





*[ The glass pyramid is a symbol that defines the entry to the Louvre.*

*It is placed precisely at the center of gravity of the three pavilions. ]* I. M. Pei

# Facts about the Louvre

Location: ..... Paris, France  
Construction Period:..... 1190 to present  
Area covered: ..... 60,600 m<sup>2</sup> (652,300 sq ft)  
Architectural style: ..... A blend of Renaissance to Modernist

For more information about the Louvre please visit: [www.louvre.fr](http://www.louvre.fr)



Pyramide du Louvre, original work of I.M. Pei © Musée du Louvre, Dist. RMN/ Antoine Mongodin



## Le Louvre

Le Louvre, qui a connu de nombreuses mutations au cours de son histoire, domine la ville de Paris depuis la fin du XII<sup>e</sup> siècle. C'est aujourd'hui le musée le plus visité au monde, célèbre pour ses chefs-d'œuvre tels que *La Joconde* de Léonard de Vinci, ainsi que pour son architecture spectaculaire, symbole à la fois des styles Renaissance et moderne.



© Musée du Louvre, Dist RMN/ Olivier Ouadah



Pyramide du Louvre : œuvre originale c11M, Pef  
© Musée du Louvre, Dist RMN/ Phodia



Pyramide du Louvre : œuvre originale d'I.M. Pei © Musée du Louvre, Dist. RMN Olivier Ouadah

# Histoire

## *De la forteresse au musée*

Le Louvre était à l'origine une forteresse, construite à la fin du XII<sup>e</sup> siècle pour protéger la ville de Paris. Située à l'extrémité ouest, la structure s'est retrouvée enfermée à l'intérieur de la ville au fur et à mesure de son expansion. La sombre forteresse médiévale a été continuellement modifiée et agrandie avant d'être transformée en palais royal de style Renaissance à partir de 1546.

En 1678, lorsque le roi Louis XIV quitta le Louvre pour installer sa cour au château de Versailles récemment agrandi, la majeure partie de la collection d'art royale resta au Louvre. Plusieurs institutions culturelles et sociétés savantes s'installèrent au Louvre, qui devint également une résidence pour artistes. En 1699, l'Académie royale de peinture et de sculpture organisa sa première exposition publique dans la Grande Galerie.

La transformation du Louvre en musée tel que nous le connaissons aujourd'hui commença avec la Révolution française. En 1791, l'Assemblée constituante décréta que le Louvre était un lieu destiné « à la réunion de tous les monuments des sciences et des arts ». Lorsque Louis XVI fut arrêté en 1792, sa collection d'art devint bien national. Le musée du Louvre ouvrit officiellement un an plus tard, offrant au public un accès gratuit à une collection composée, entre

autres, d'œuvres de Léonard de Vinci, de Raphaël, de Poussin et de Rembrandt.

Les deux siècles qui suivent voient la restauration et l'abolition de la monarchie française, l'ère napoléonienne et la proclamation de cinq républiques françaises. La collection du musée augmenta pendant cette période agitée, et au début des années 1980, il devint clair qu'une rénovation importante était nécessaire pour améliorer les espaces d'exposition et les conditions d'accueil des visiteurs toujours plus nombreux.



© Musée du Louvre, Dist. RMN/ Olivier Ouadah

# Rénovation

## *La rencontre entre l'ancien et le moderne*

Lorsque le président François Mitterrand arriva au pouvoir en 1981, il lança un ambitieux programme de création de monuments architecturaux modernes dans Paris, qui visait à symboliser le rôle de la France dans l'art, la politique et l'économie. Le plus célèbre de ces Grands projets est la transformation et l'agrandissement du Louvre.

En visitant des musées en Europe et aux États-Unis, le comité chargé de la supervision du projet fut particulièrement impressionné par le bâtiment Est de la National Gallery of Art à Washington. Son architecte, Ieoh Ming Pei, fut invité à Paris et se vit confier la direction de ce vaste projet de rénovation.

Le plus grand défi auquel Pei dut faire face était le manque d'espace. La configuration du Louvre n'avait pas changé depuis 1874 : deux ailes perpendiculaires au bâtiment le plus ancien du musée, le tout formant une structure rectangulaire autour de la cour Napoléon.

L'idée de Pei fut de creuser le sol de la cour centrale pour y bâtir l'entrée principale et une série de couloirs souterrains la reliant aux différentes ailes. Les visiteurs descendraient dans un vaste hall et pourraient accéder rapidement aux principaux bâtiments du Louvre. Pei

proposa également de réorganiser et de redistribuer les collections et de couvrir plusieurs petites cours intérieures pour créer plus d'espaces d'exposition.

Cependant, la proposition de Pei de construire une pyramide de verre et d'acier au-dessus de la nouvelle entrée fit polémique. La pyramide fut même qualifiée de « gadget gigantesque et ruineux » par l'un des nombreux opposants au projet. Pour Pei, cette forme offrait non seulement au nouveau hall la lumière du jour, mais elle était aussi « la plus compatible avec l'architecture du Louvre ».

L'hostilité au projet faiblit un peu lorsque Pei installa une maquette grandeur nature de la pyramide dans la cour. La nouvelle entrée, avec sa célèbre pyramide, fut inaugurée en mars 1989 et devint très vite une icône architecturale pour le musée du Louvre récemment rénové.





Pyramide du Louvre : œuvre originale d'I.M. Pei © Musée du Louvre, Dist RMNV Antoine Mongodin

## Le Louvre aujourd'hui

La rénovation du Louvre s'acheva en 1993 et se révéla être un grand succès : le nombre de visiteurs doubla au cours de la première année. Avec une superficie de 60 600 m<sup>2</sup> et plus de 400 000 œuvres d'art dans sa collection, le Louvre est aujourd'hui l'un des musées les plus grands et les plus impressionnants du monde ; avec près de 10 millions de visiteurs chaque année, il est aussi le plus visité.



© Musée du Louvre, Dist RMNV Franck Bohbot

*[ C'est un symbole de rupture avec les traditions architecturales du passé.*

*C'est une œuvre de notre époque. ]*

I. M. Pei





Pyramide du Louvre : oeuvre originale d'I.M. Pei © Musée du Louvre, Dist. RMN/Stephane Olivier

# L'architecte

*Ieoh Ming Pei*

Ieoh Ming Pei est né en Chine en 1917. À l'âge de 17 ans, il partit aux États-Unis pour étudier l'architecture au Massachusetts Institute of Technology (MIT). Inspiré par le travail de Le Corbusier et le style international d'architecture, qui commençait alors à s'épanouir, il poursuivit ses études à la Harvard Graduate School of Design, où il fit la connaissance de Walter Gropius et Marcel Breuer, deux figures de proue du mouvement européen du Bauhaus.

En 1955, après avoir travaillé pour le cabinet de promotion new-yorkais Webb & Knapp sur diverses structures de grande ampleur un peu partout aux États-Unis, Pei créa sa propre entreprise, I. M. Pei & Associates. Pei et son équipe travaillèrent sur plusieurs grands projets, notamment la Bibliothèque Kennedy à Boston,

l'hôtel de ville de Dallas et le nouveau bâtiment Est de la National Gallery of Art à Washington. C'est ce dernier bâtiment qui a retenu l'attention des responsables du projet de rénovation du Louvre.

Pei devint alors le premier architecte étranger à travailler sur le Louvre, et le fait qu'un projet national aussi prestigieux soit confié à une personnalité considérée comme un « maître de l'architecture moderne » fut accueilli avec un certain scepticisme par beaucoup de gens en France. Pei lui-même était conscient que « l'histoire de Paris est gravée dans les pierres du Louvre ». Même si ses propositions, en particulier la pyramide de verre, furent d'abord accueillies avec hostilité, le projet s'acheva avec succès et la pyramide devint son œuvre la plus célèbre.



© EPFL, Patrice Astier

*[ La pyramide de verre est le symbole de l'entrée du Louvre par excellence.*

*Elle est située précisément au centre de gravité des trois pavillons. ]*

I. M. Pei

# Informations sur le Louvre

Lieu : ..... Paris, France

Période de construction : ..... De 1190 à nos jours

Superficie : ..... 60 600 m<sup>2</sup>

Style architectural : ..... Mélange entre les styles Renaissance et moderne

Pour obtenir plus d'informations sur le Louvre, veuillez consulter : [www.louvre.fr](http://www.louvre.fr)



Pyramide du Louvre : œuvre originale d'I.M. Pei © Musée du Louvre, Dist. RMN/ Antoine Mongodin





Pyramide du Louvre: original work of I. M. Pei / Pyramide du Louvre: oeuvre originale d'I. M. Pei  
© Musée du Louvre, Dist. HWY / Olivier Quaden

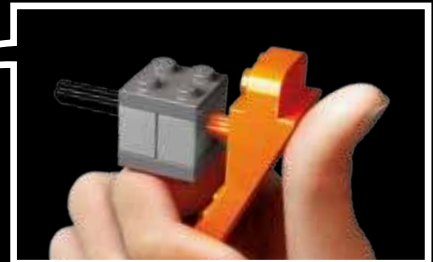
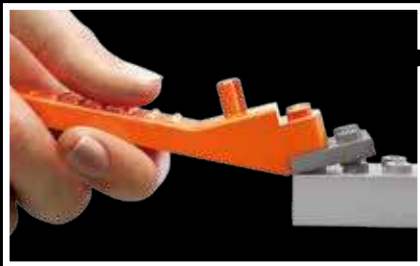
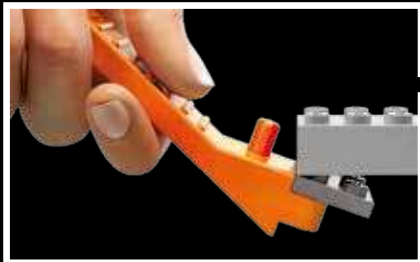

[LEGO.com/brickseparator](https://LEGO.com/brickseparator)





1x

1

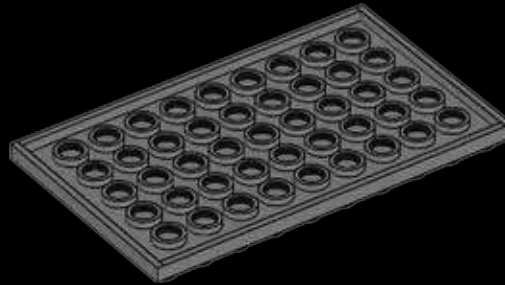

*The name Louvre refers to the word "loup", meaning wolf in English, as the place was supposedly occupied by these predators.*

*« Louvre » fait référence au mot « loup », car on supposait que ce lieu était occupé par ces prédateurs.*



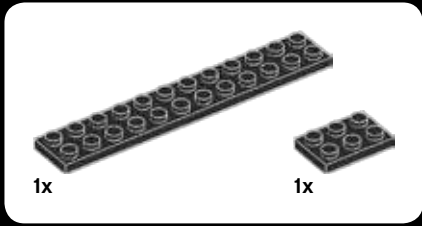

2

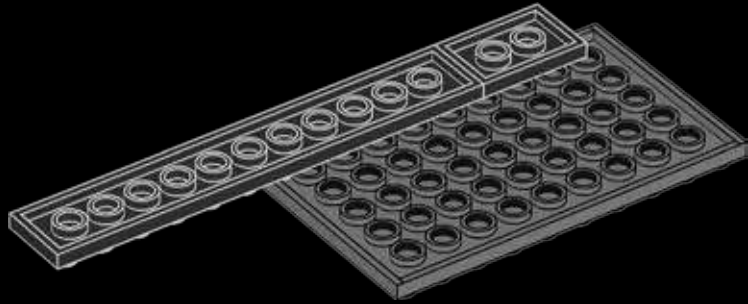



3

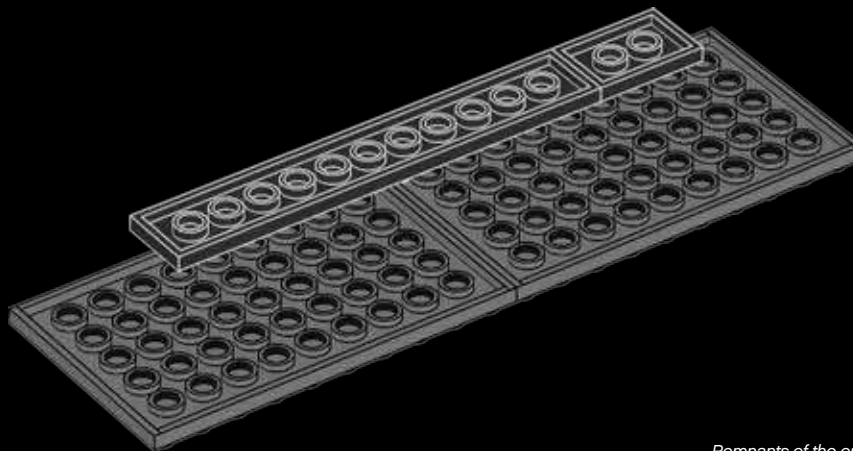

*Remnants of the original 12th century fortress are still visible in the crypt.*

*Des vestiges de la forteresse du XII<sup>e</sup> siècle sont toujours visibles dans la crypte.*





1x

4

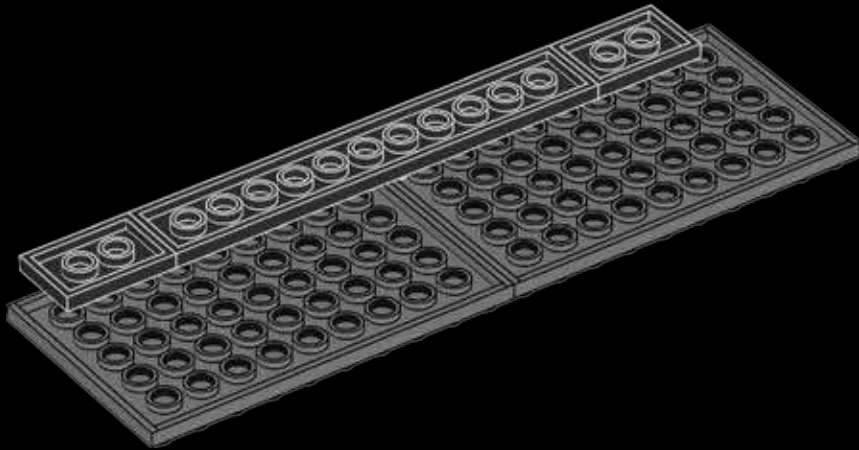



5

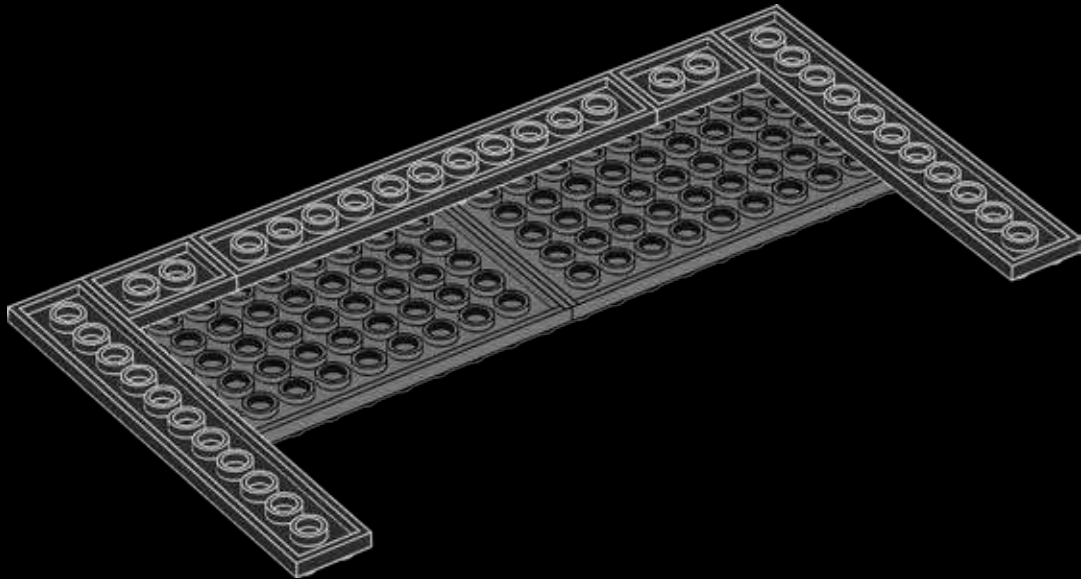



6

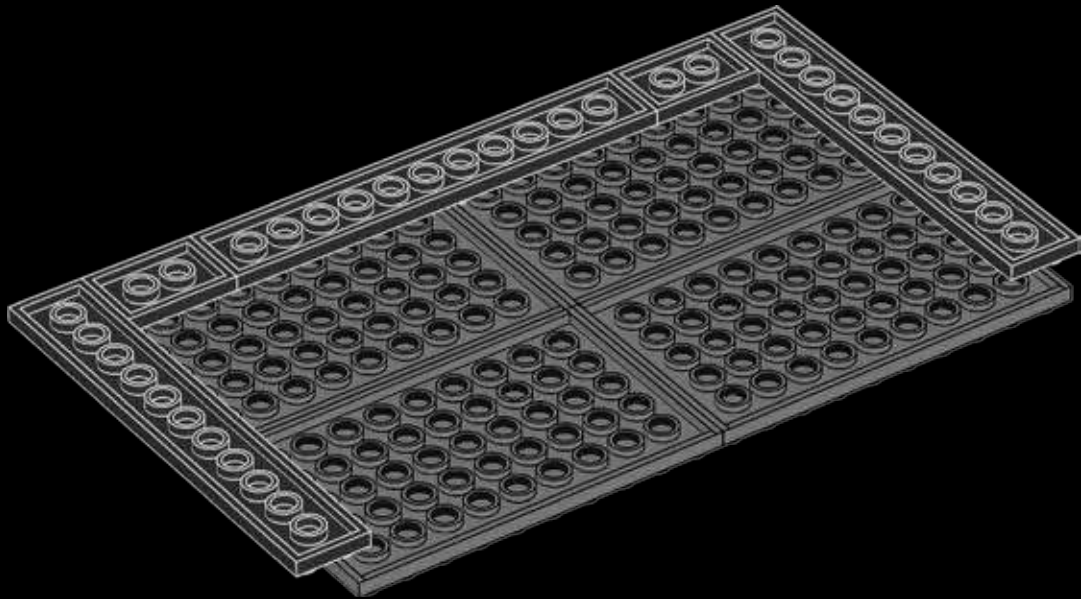



2x

7

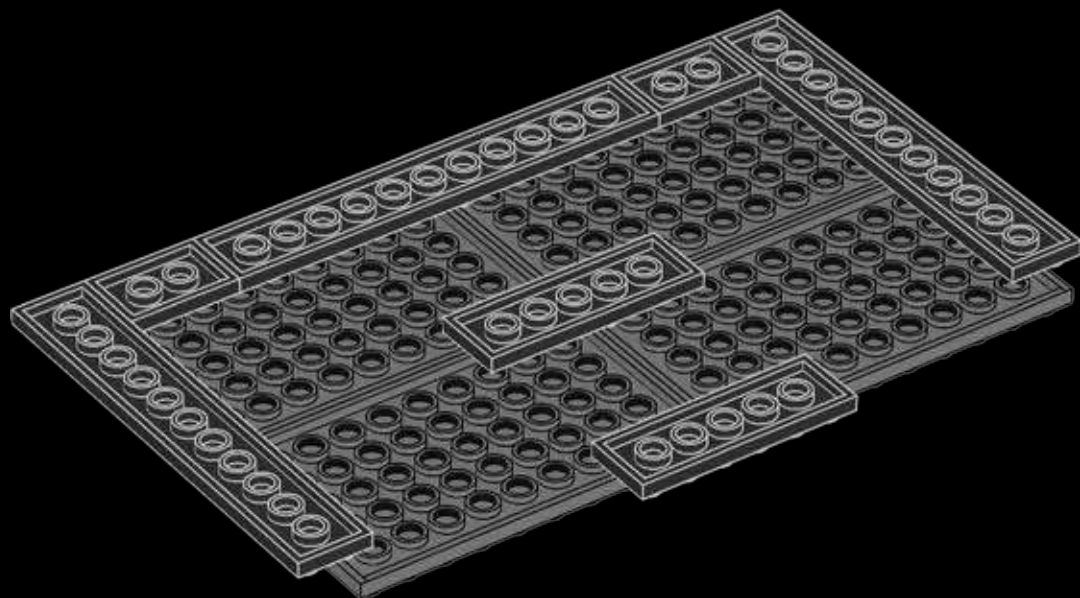



8

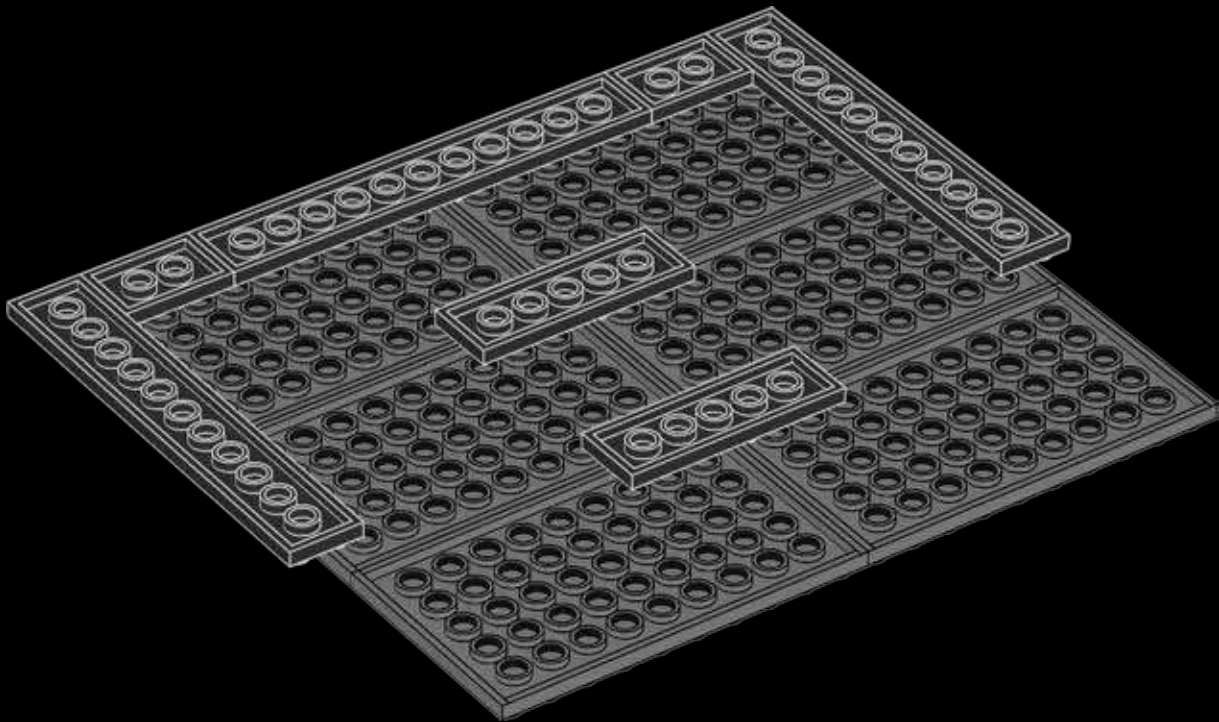



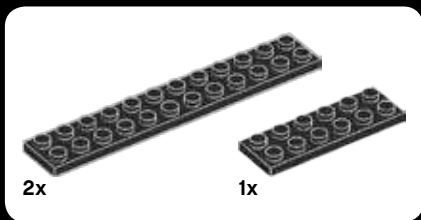

9

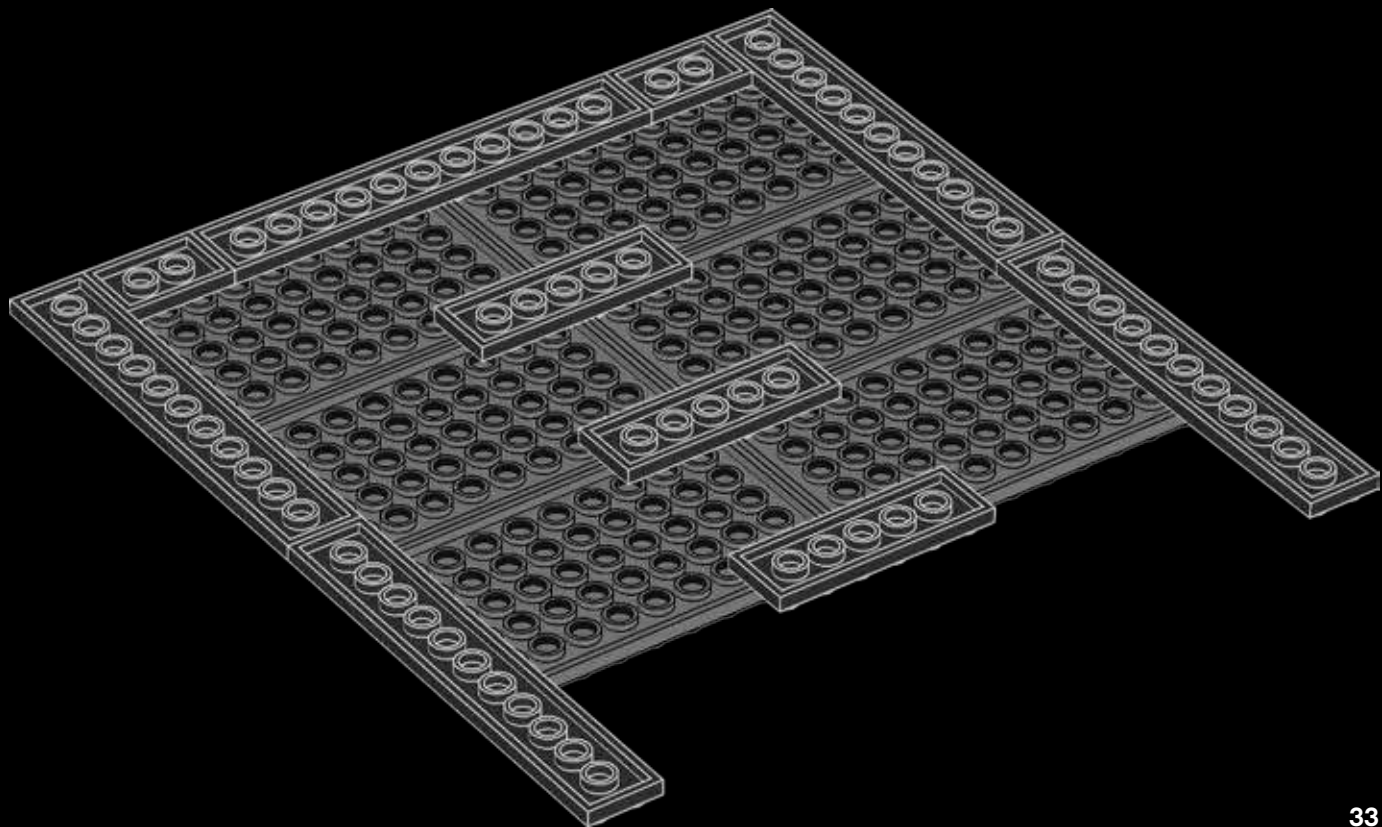



10

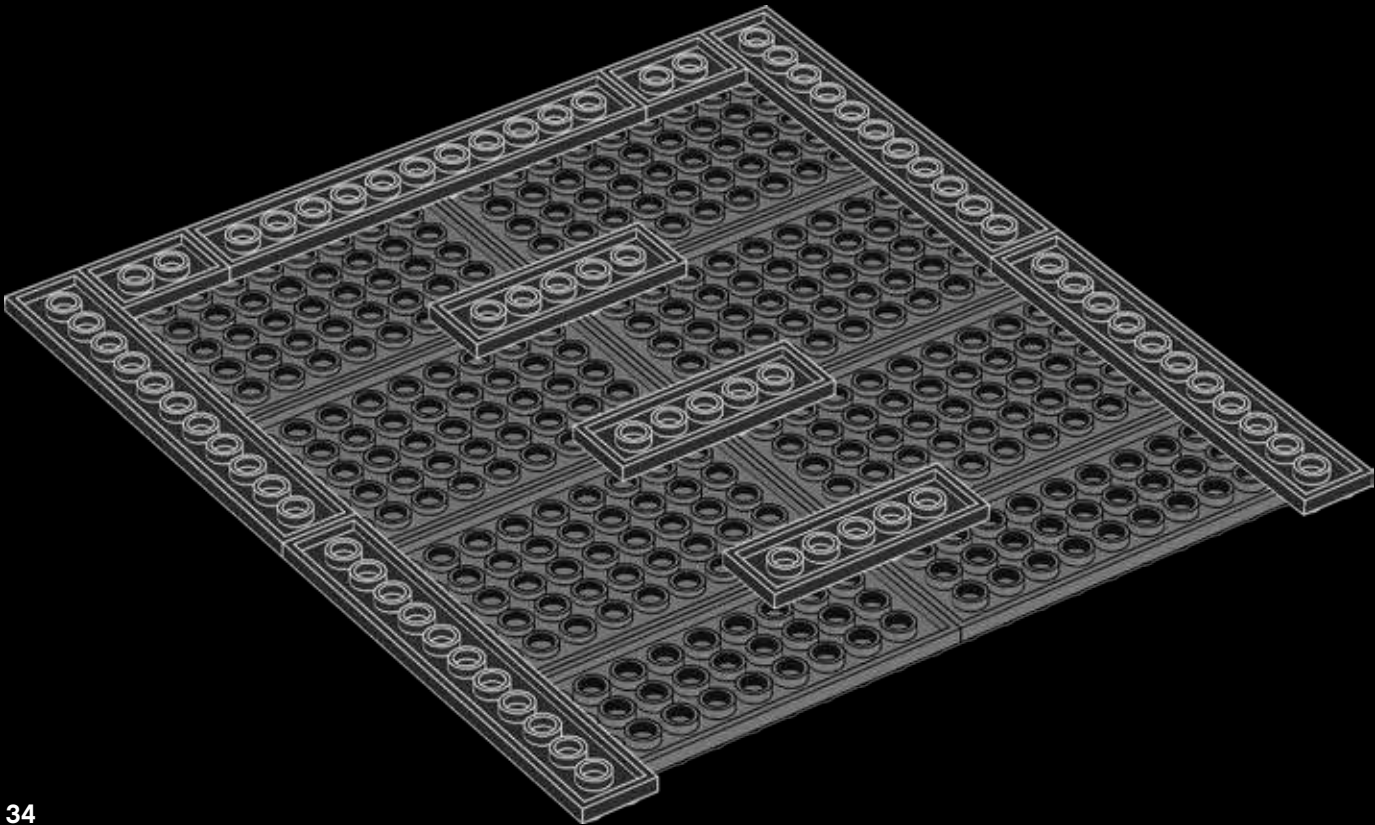

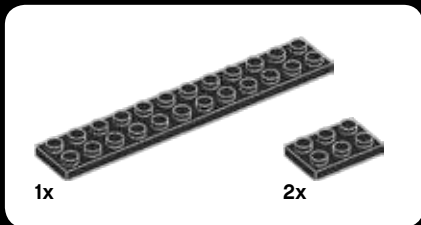

# 11

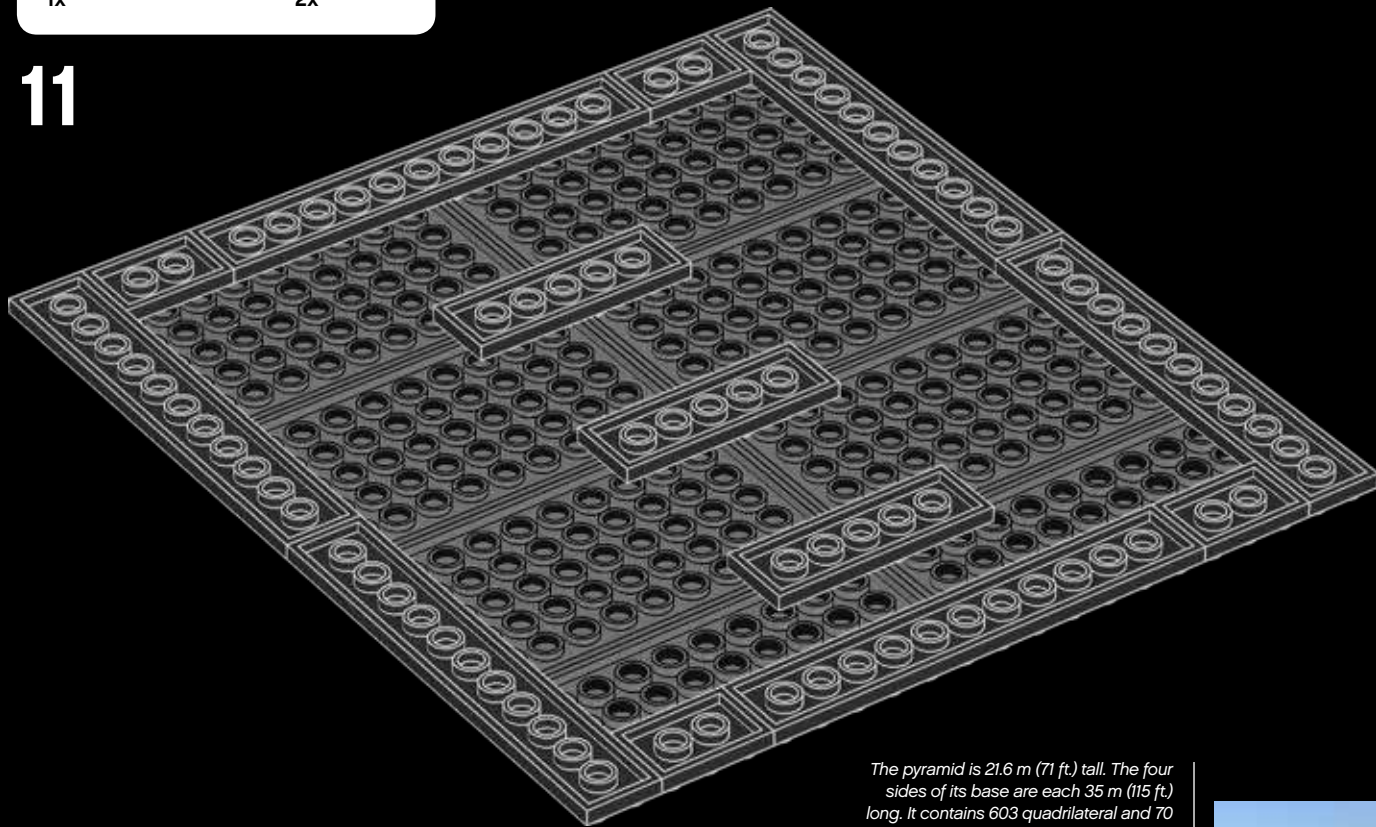

The pyramid is 21.6 m (71 ft.) tall. The four sides of its base are each 35 m (115 ft.) long. It contains 603 quadrilateral and 70 triangular pieces of glass.

La pyramide mesure 21,6 m de haut. Les quatre côtés de sa base mesurent chacun 35 m de long. Elle est composée de 603 losanges et de 70 triangles en verre.



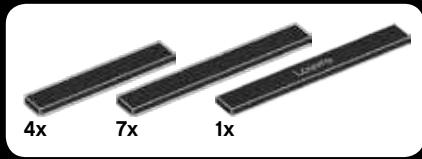

12

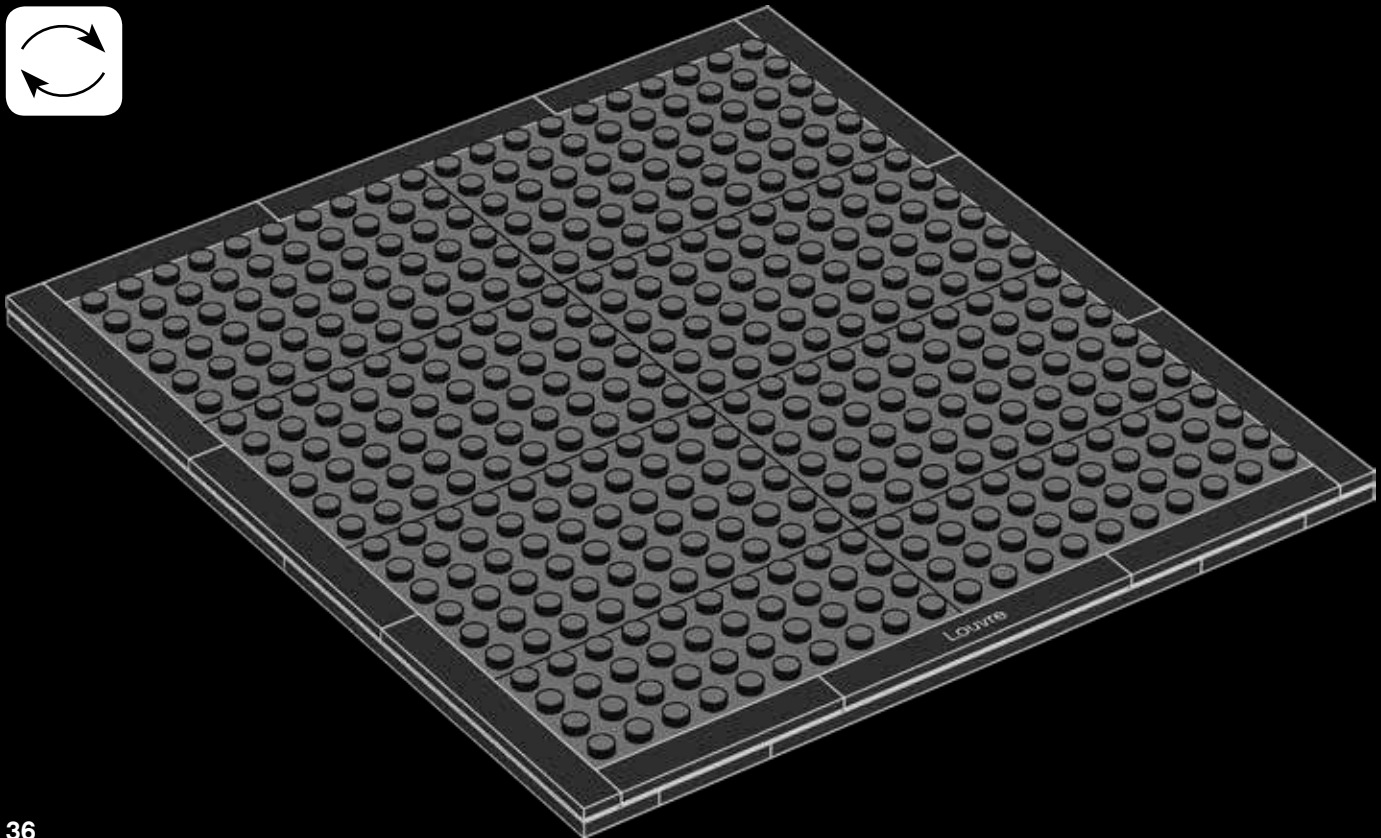



# 13

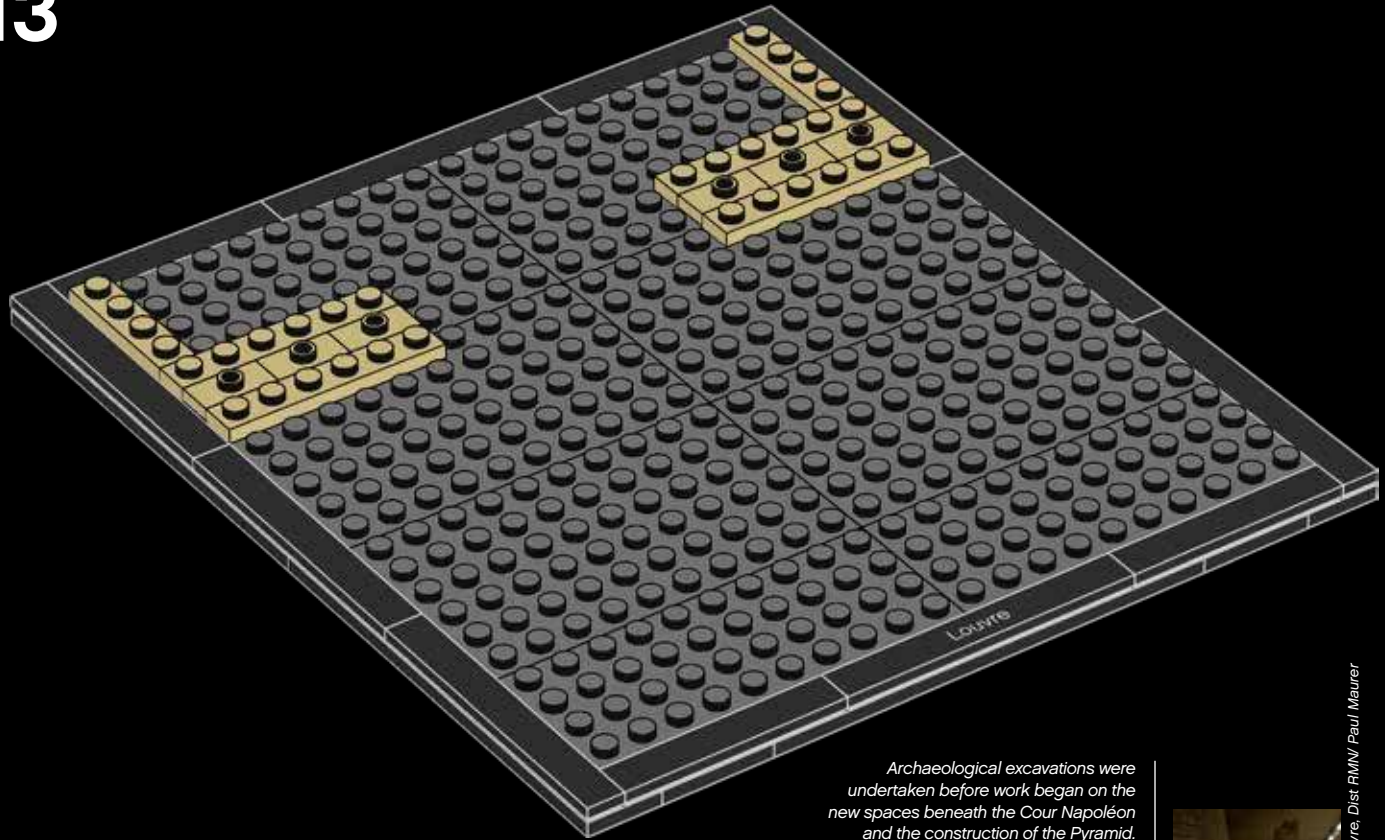

*Archaeological excavations were undertaken before work began on the new spaces beneath the Cour Napoléon and the construction of the Pyramid.*

*Des fouilles archéologiques ont été menées avant l'aménagement des nouveaux espaces sous la cour Napoléon et la construction de la pyramide.*





2x



3x



2x

# 14

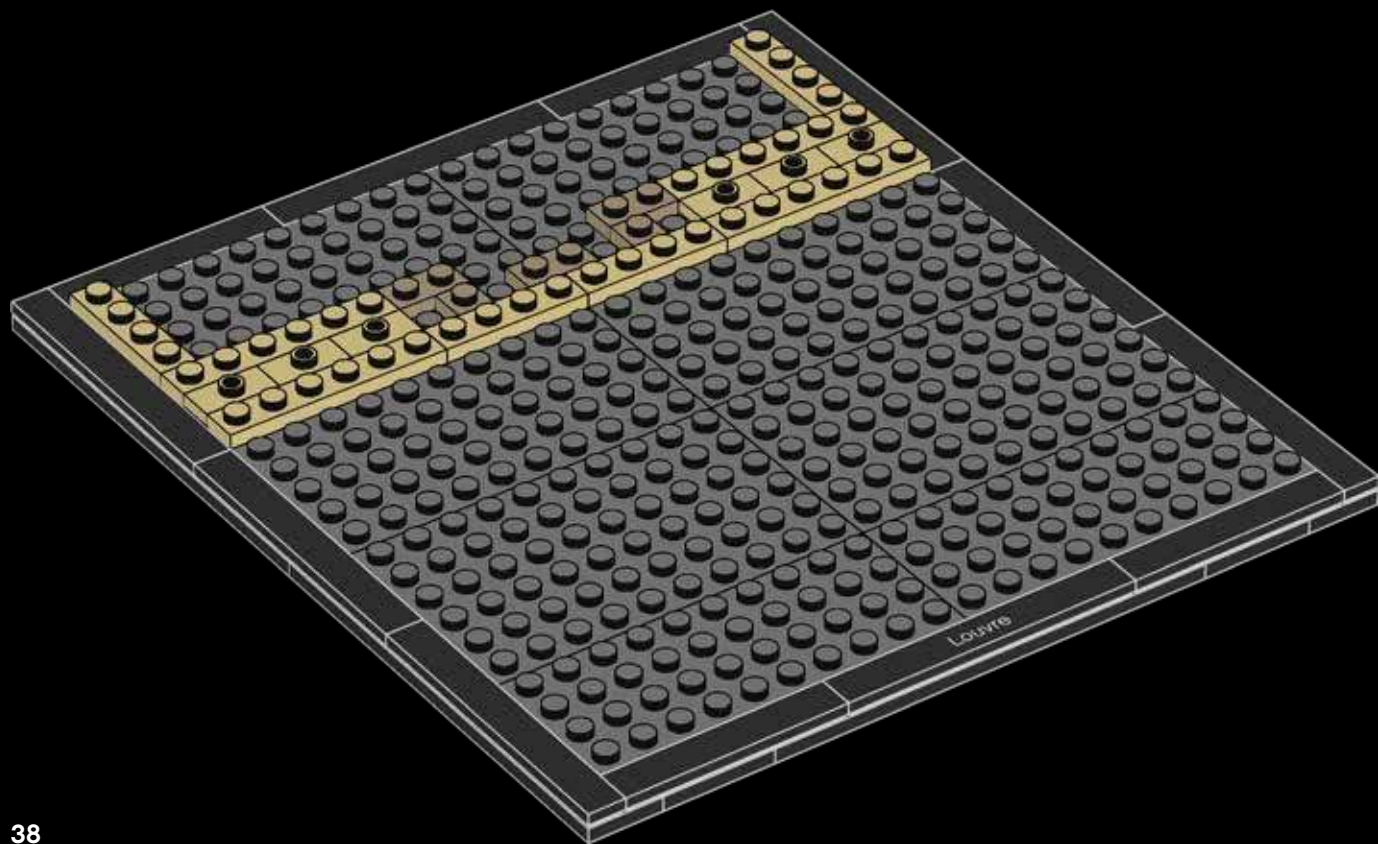

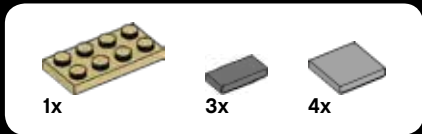

15

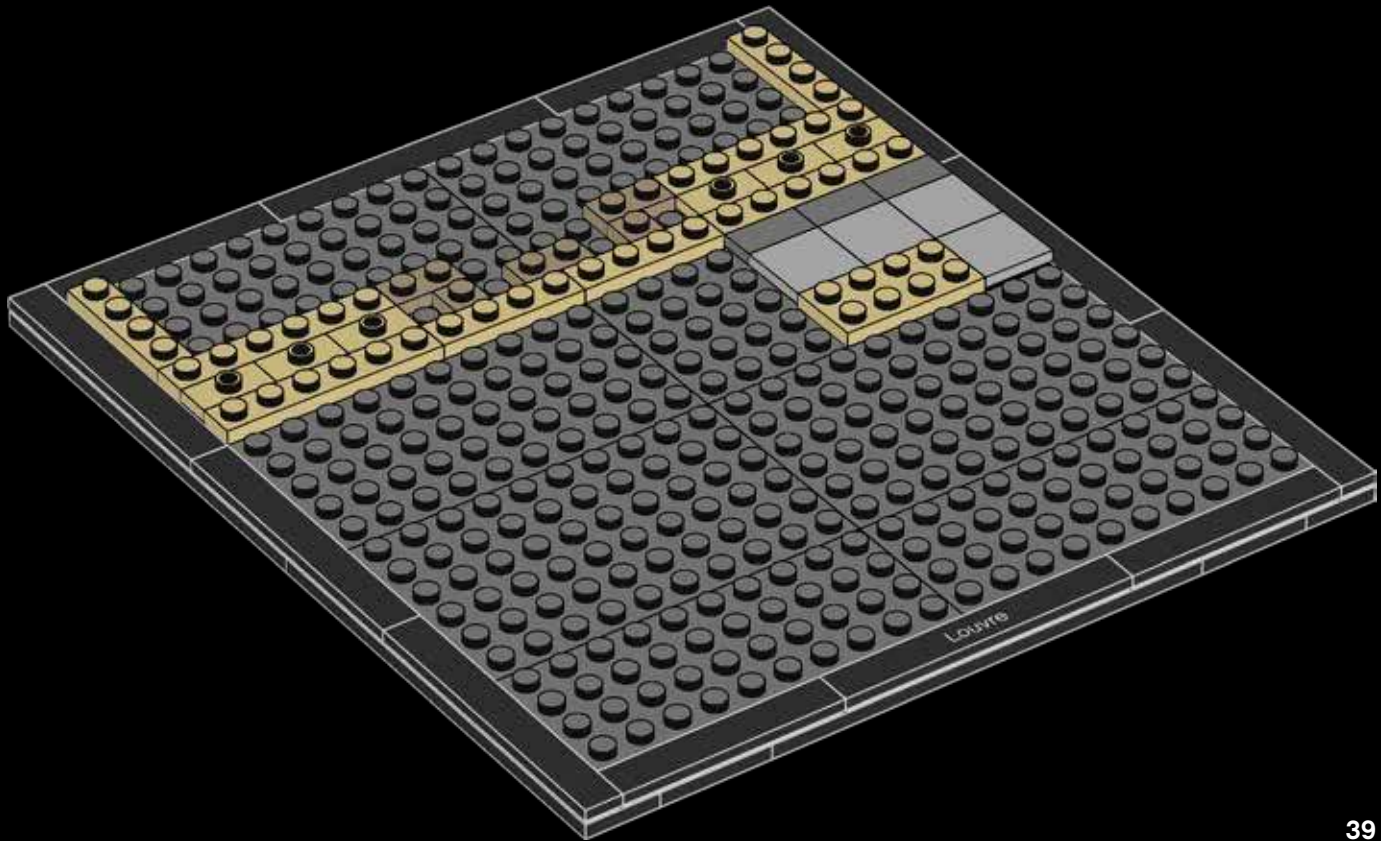



15x

# 16

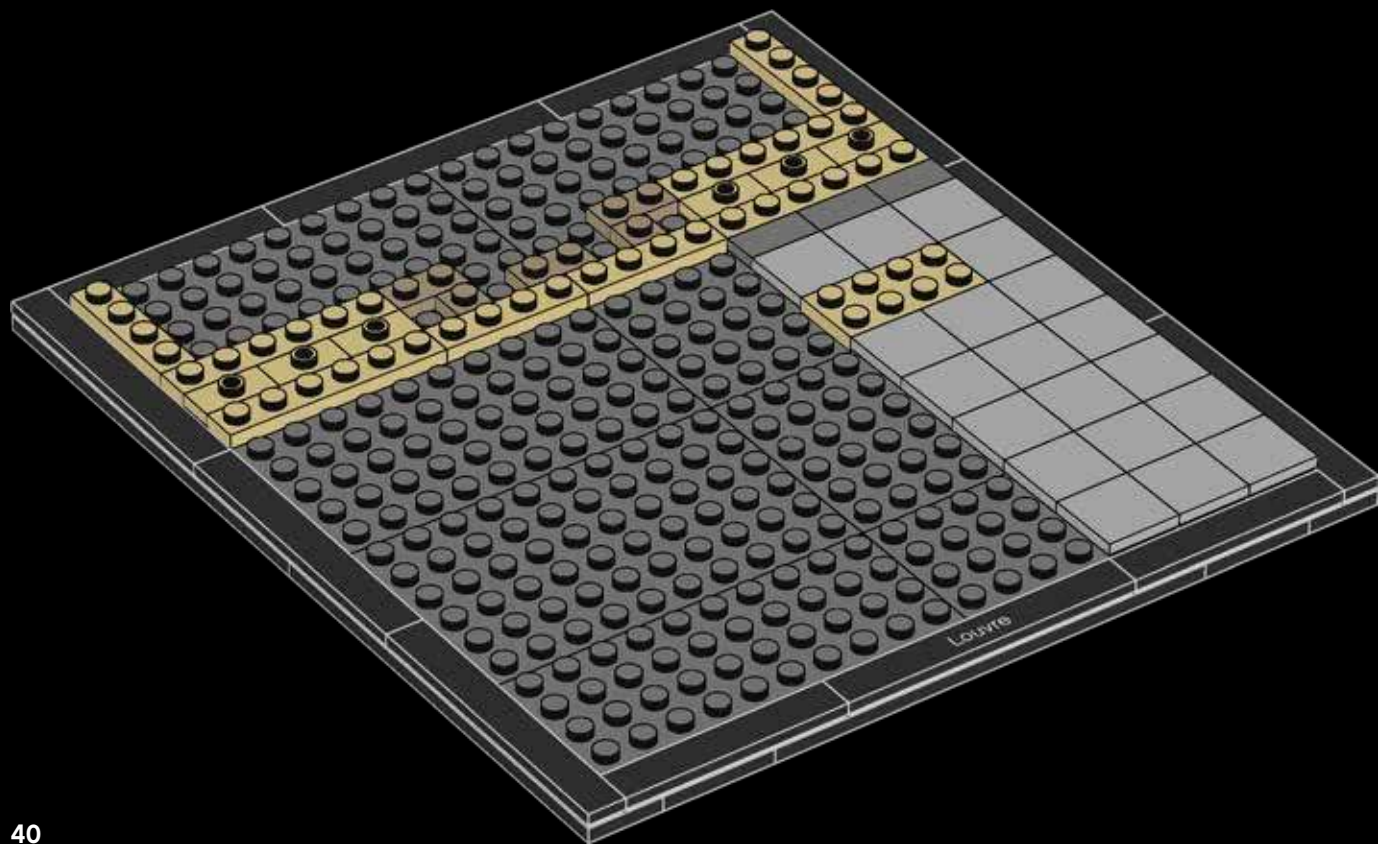



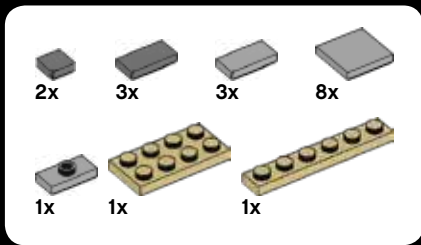

17

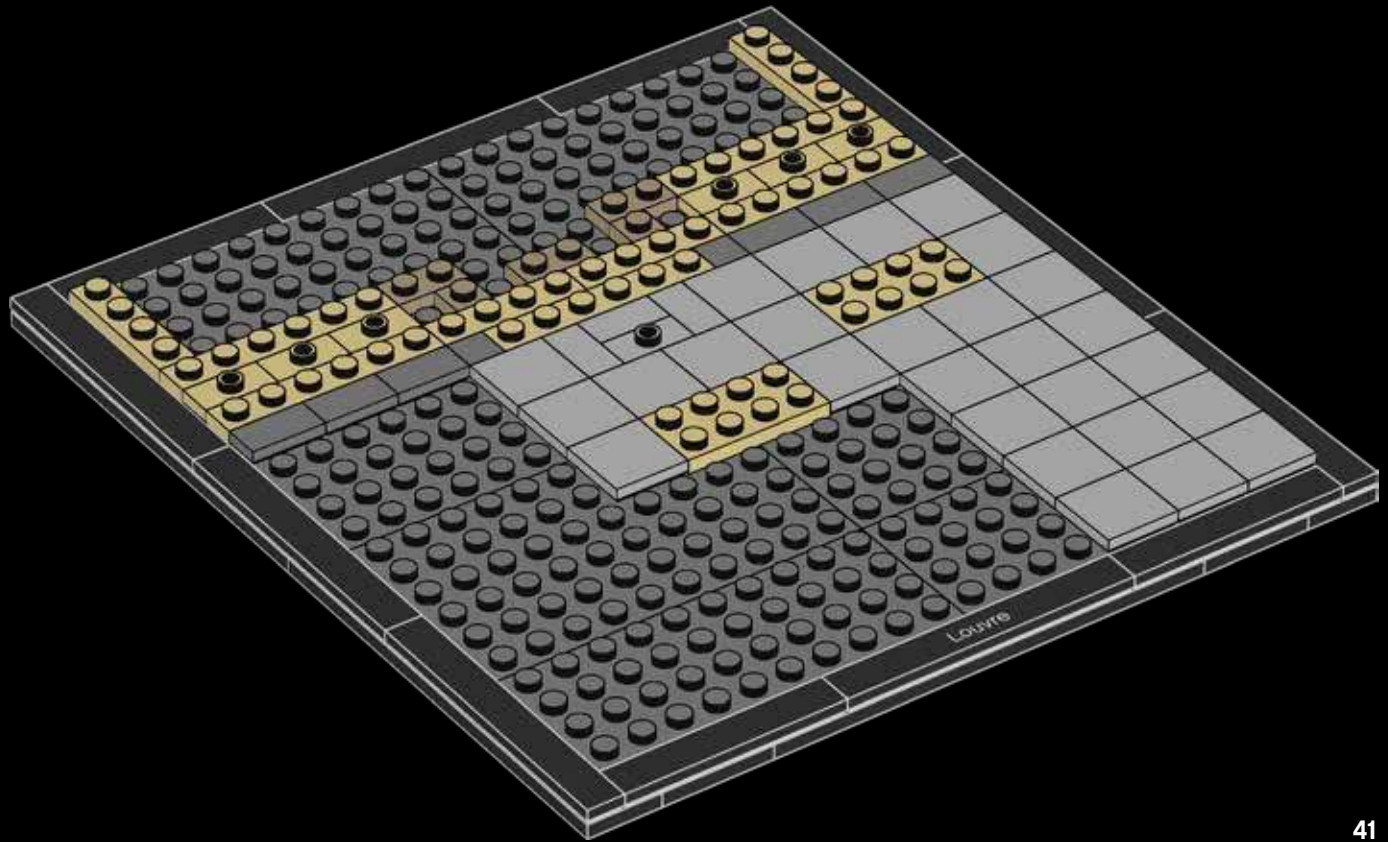

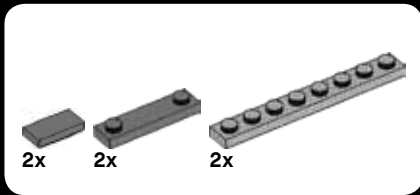

18

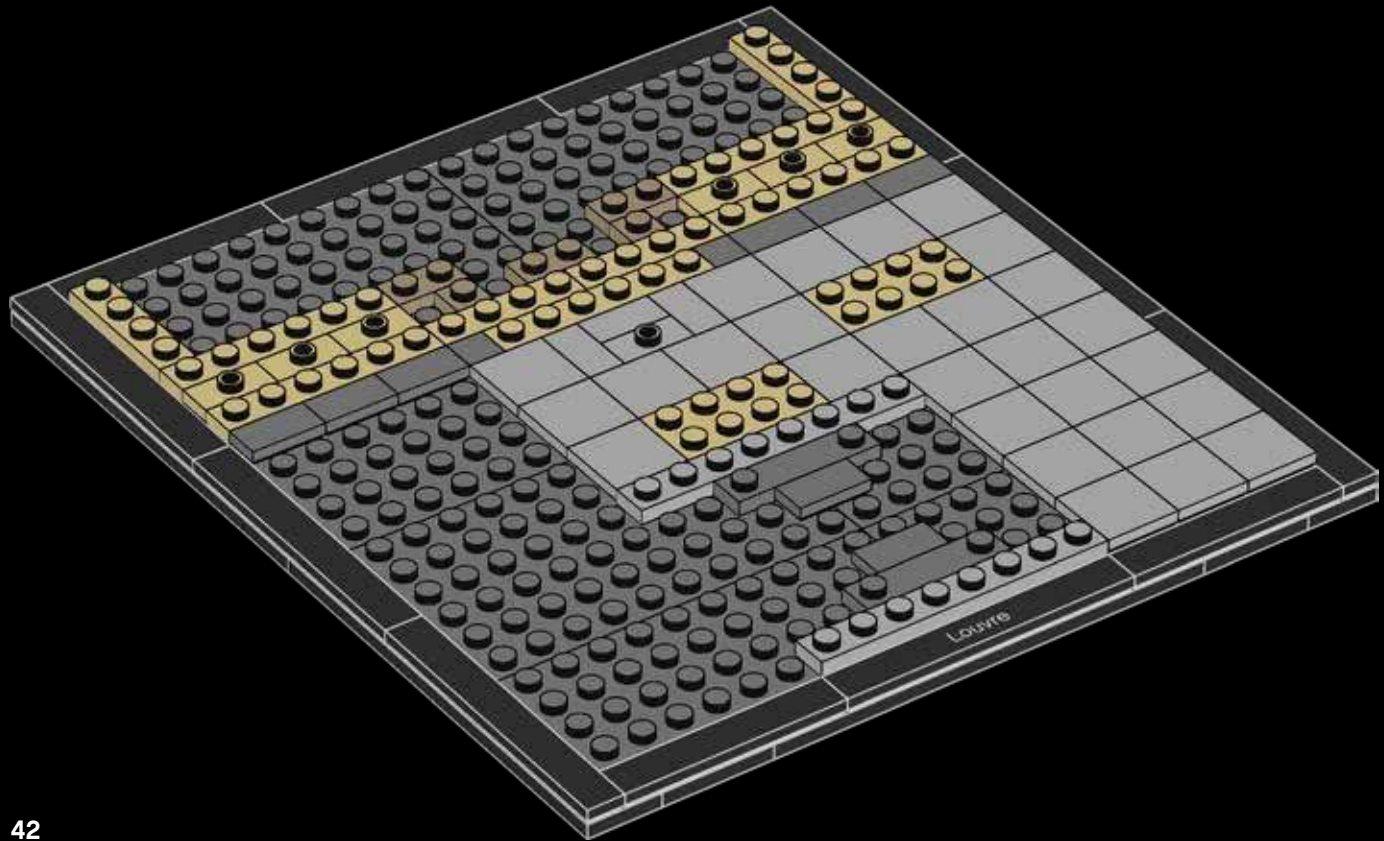

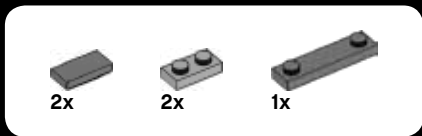

19

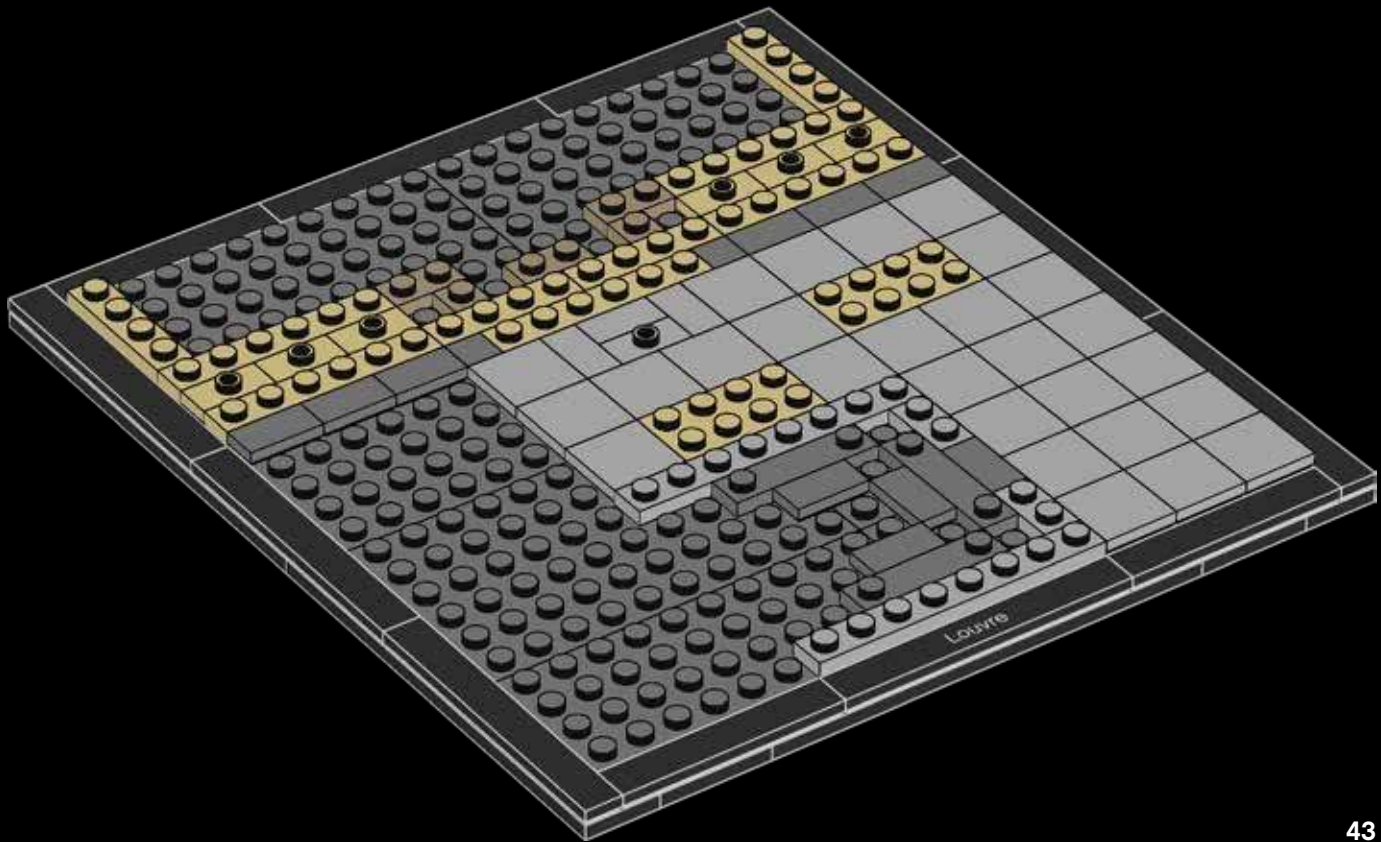

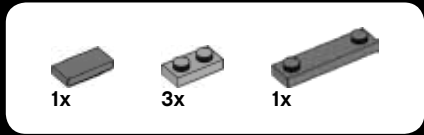

20

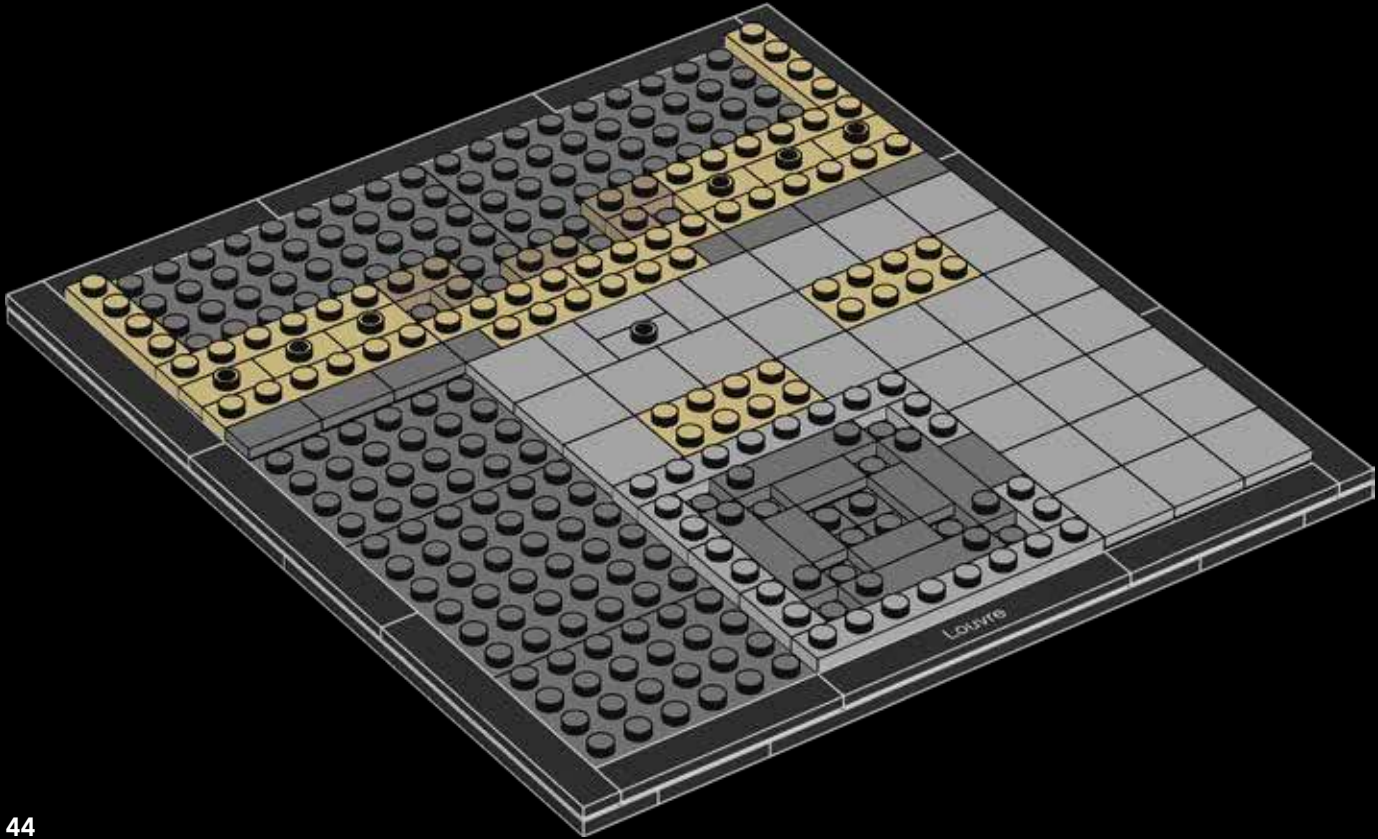

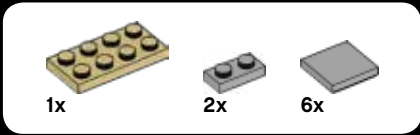

21

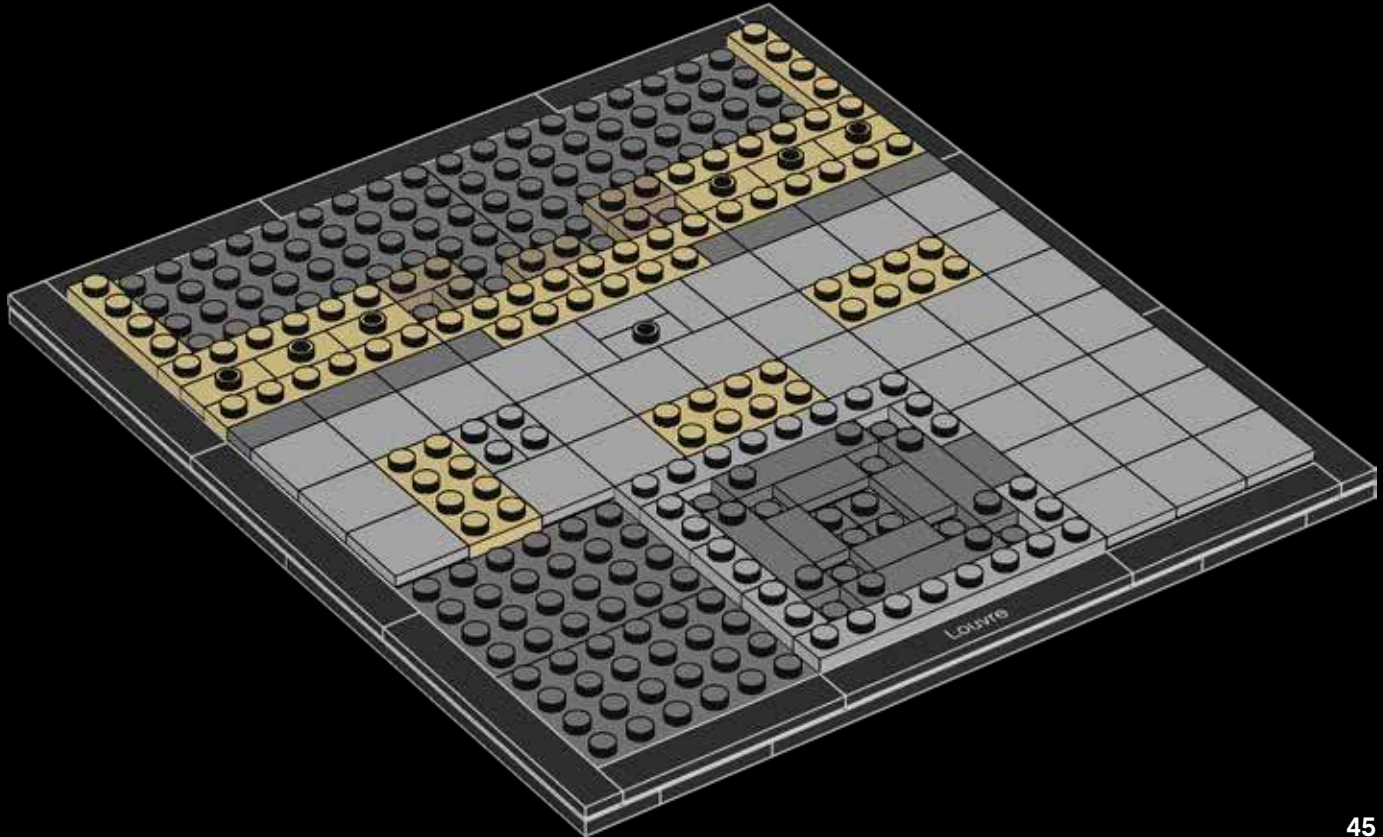

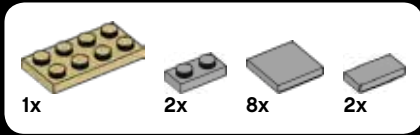

22

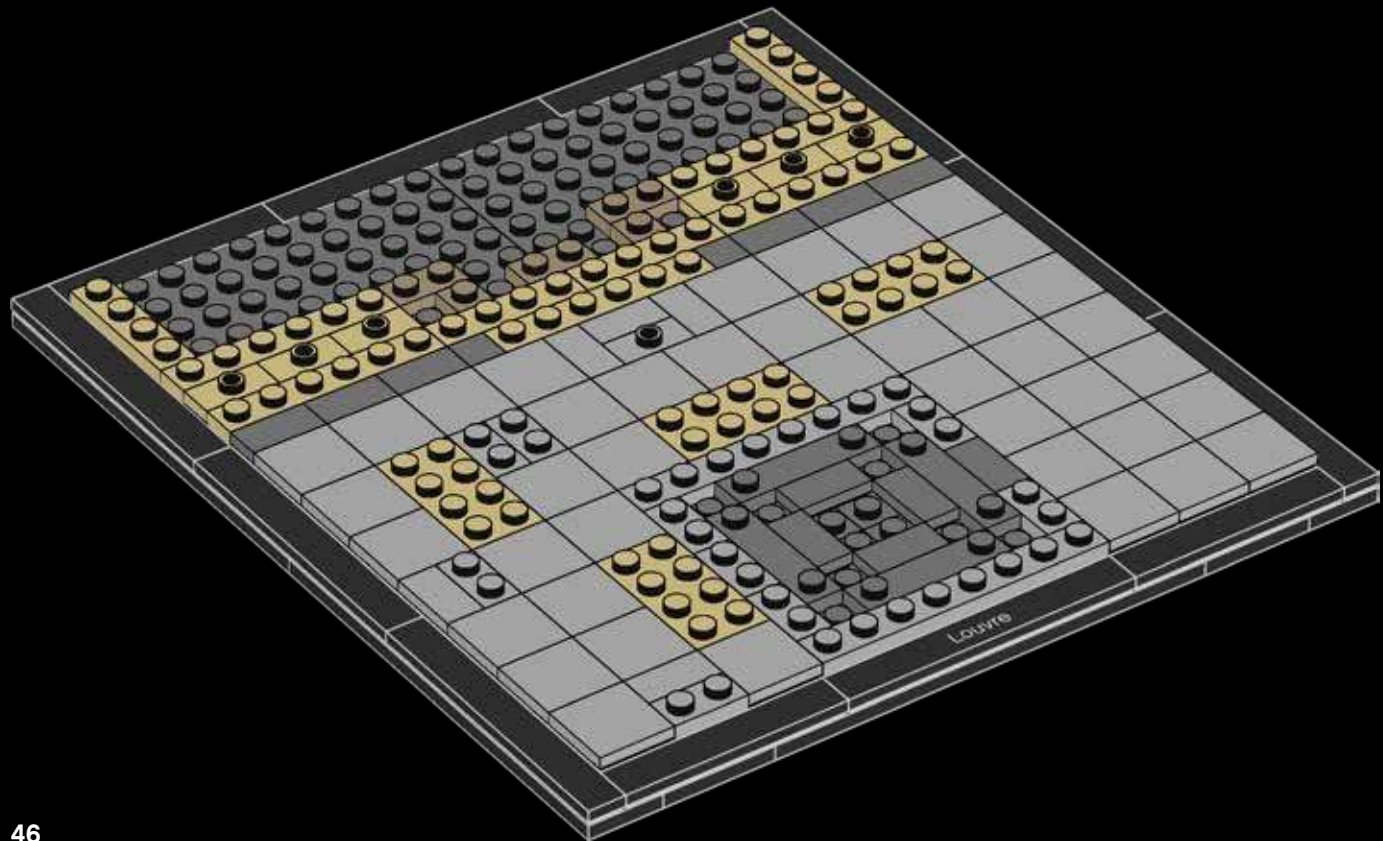



2x



1x

# 23

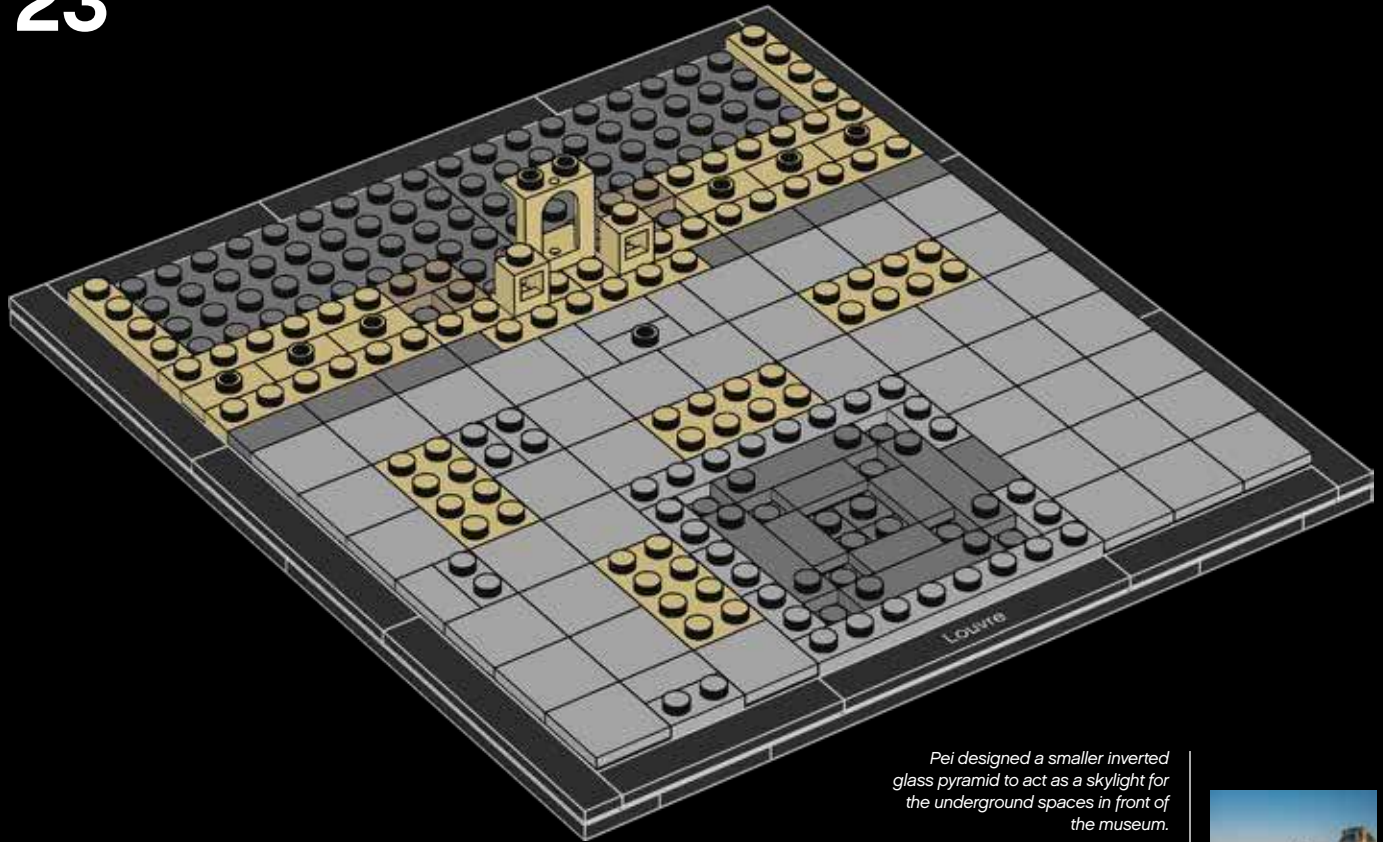

*Pei designed a smaller inverted glass pyramid to act as a skylight for the underground spaces in front of the museum.*

*Pei a conçu une pyramide de verre inversée et plus petite en guise de verrière pour les espaces souterrains devant le musée.*





2x



1x

# 24

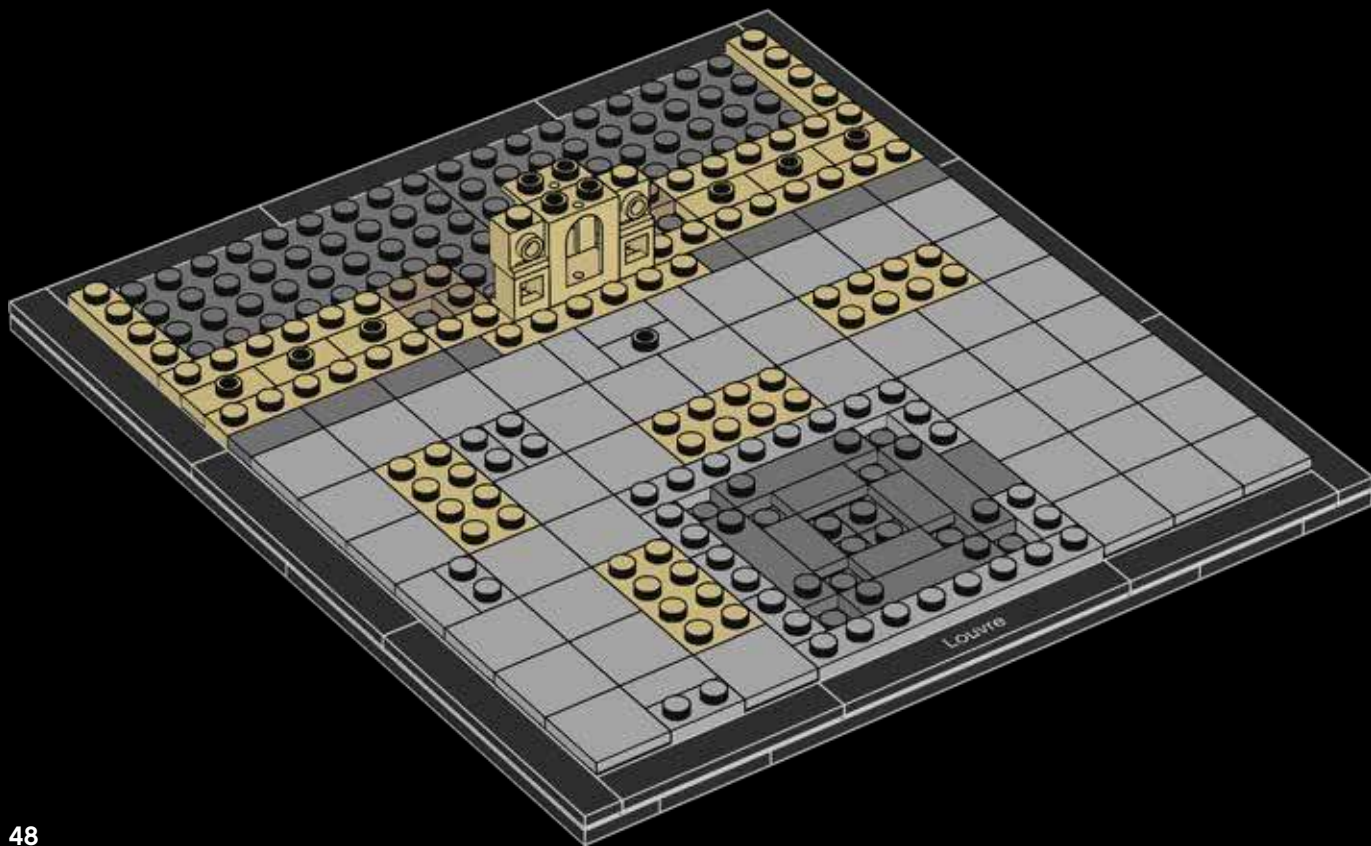





6x

25

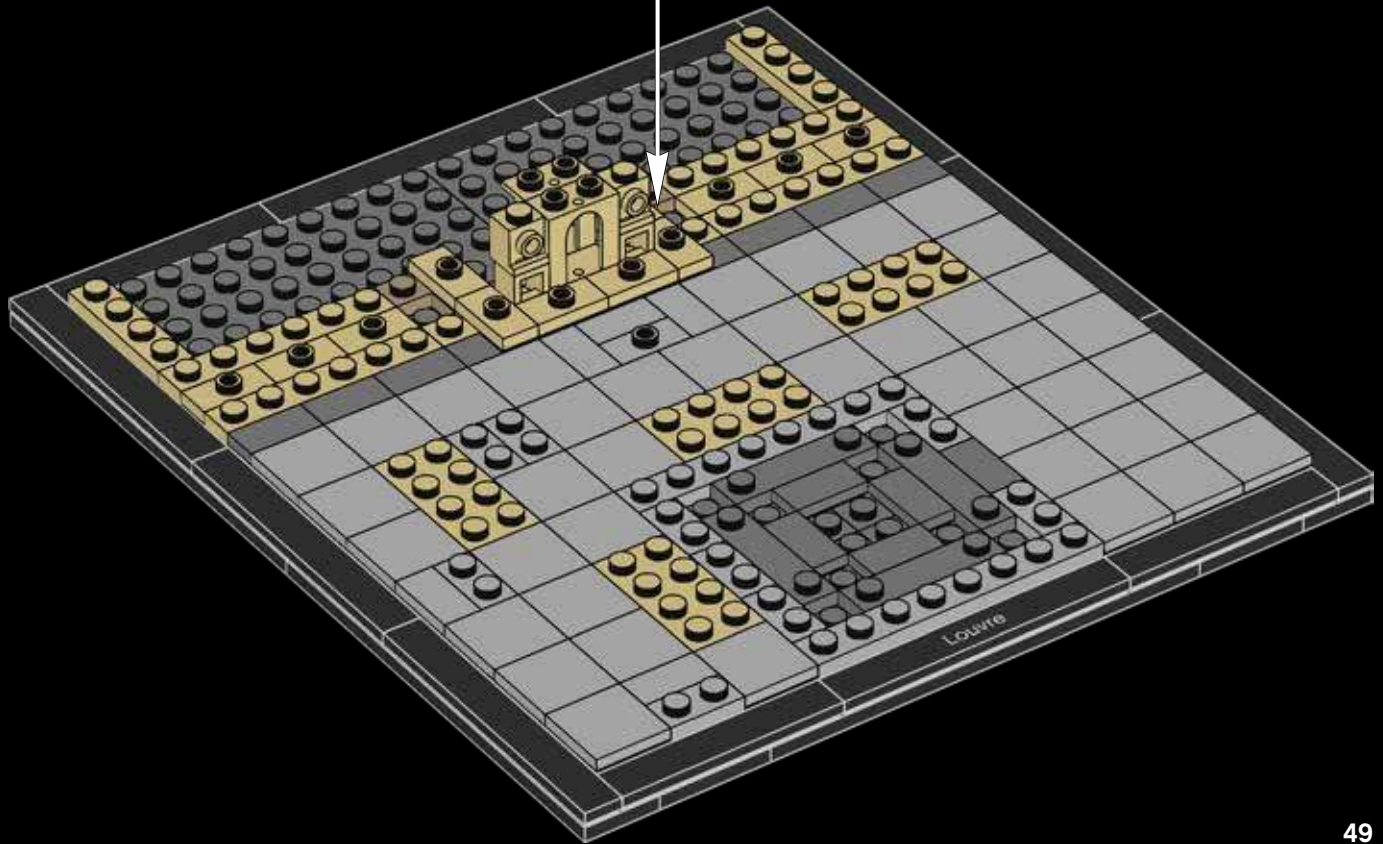

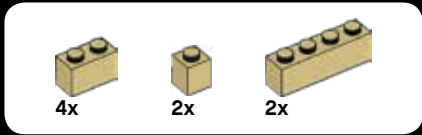

26

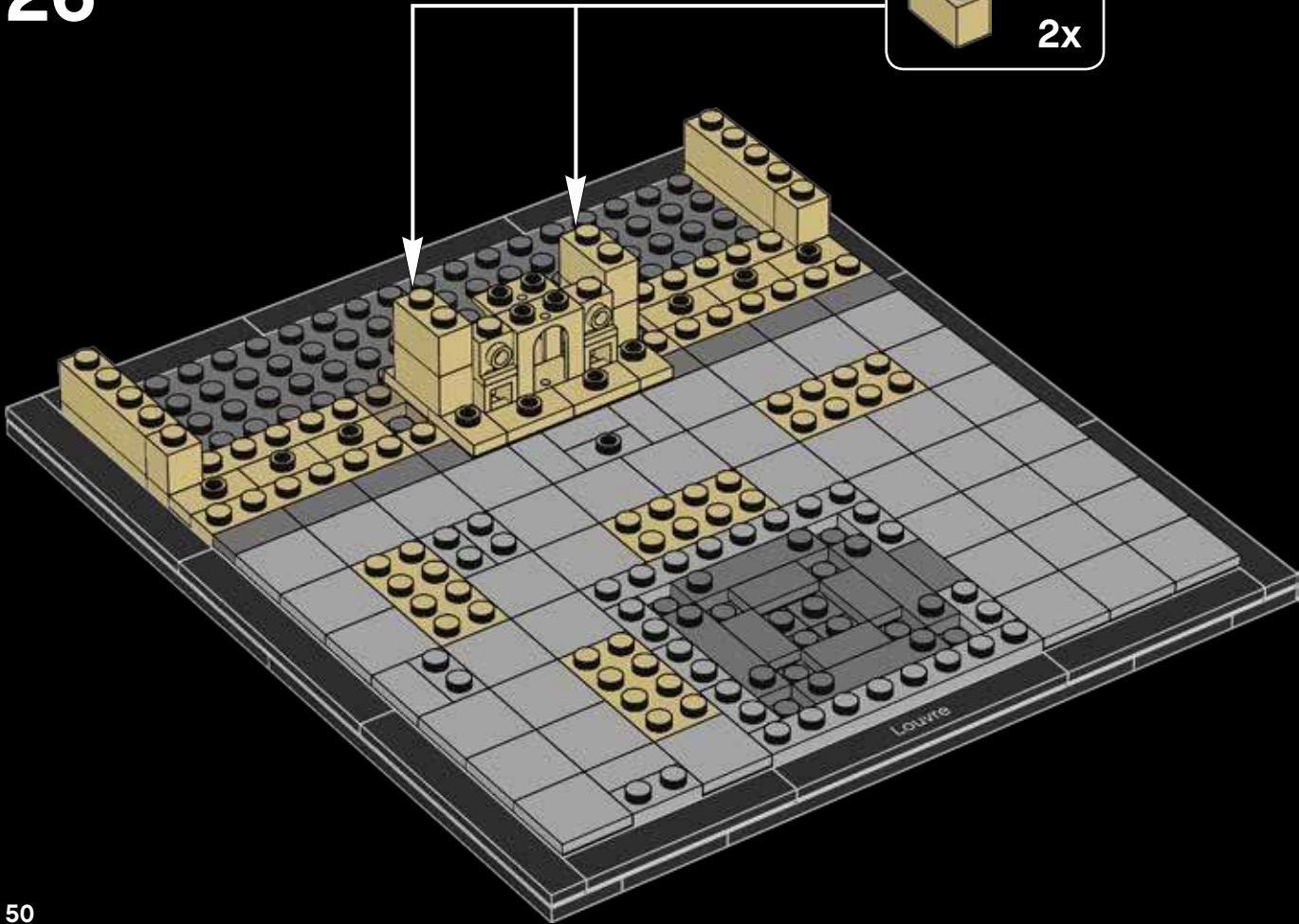
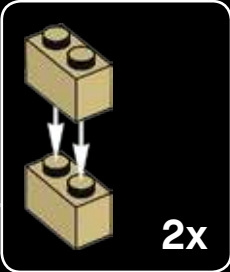

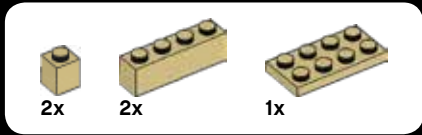

27

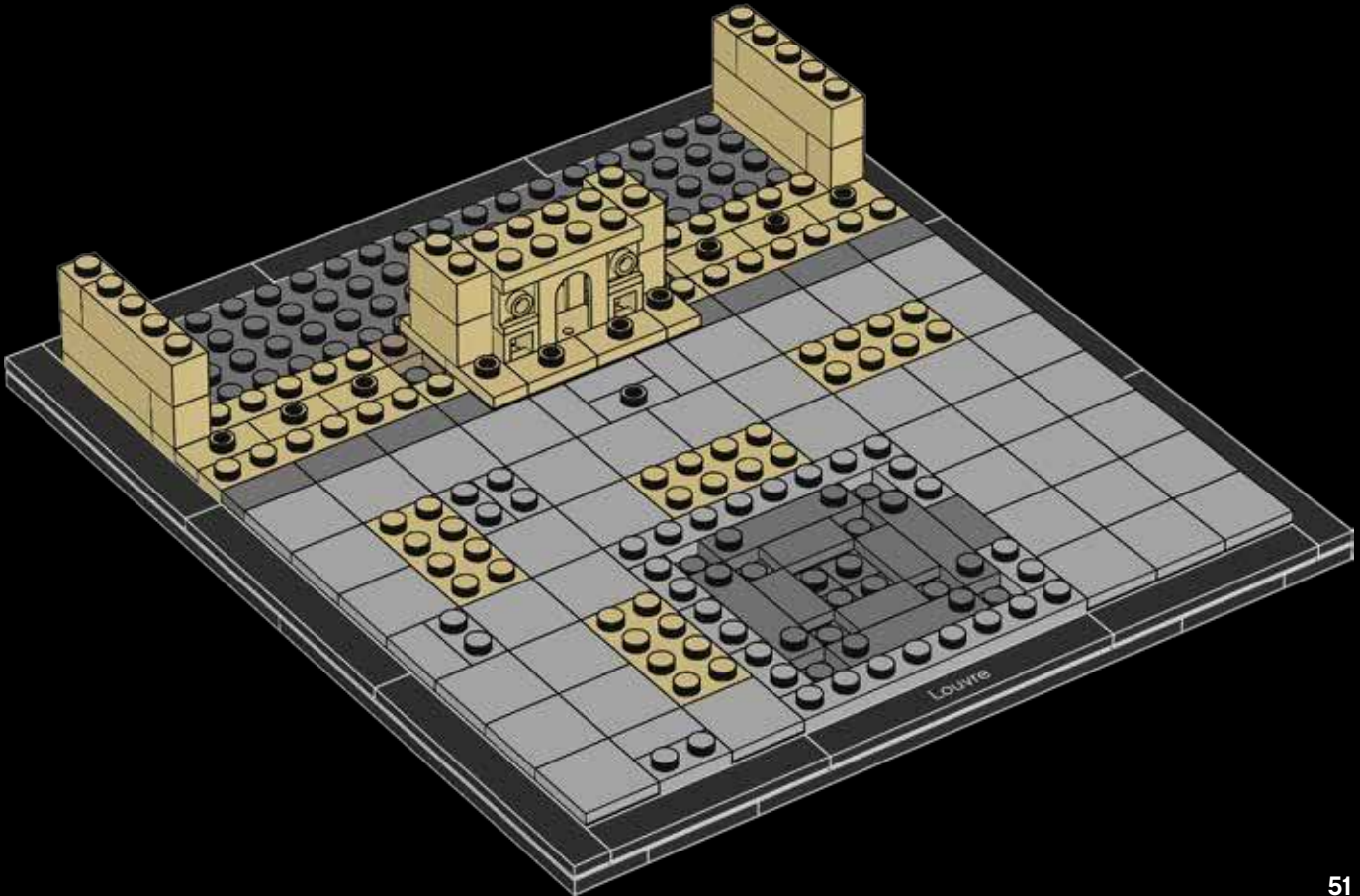



12x

28



6x

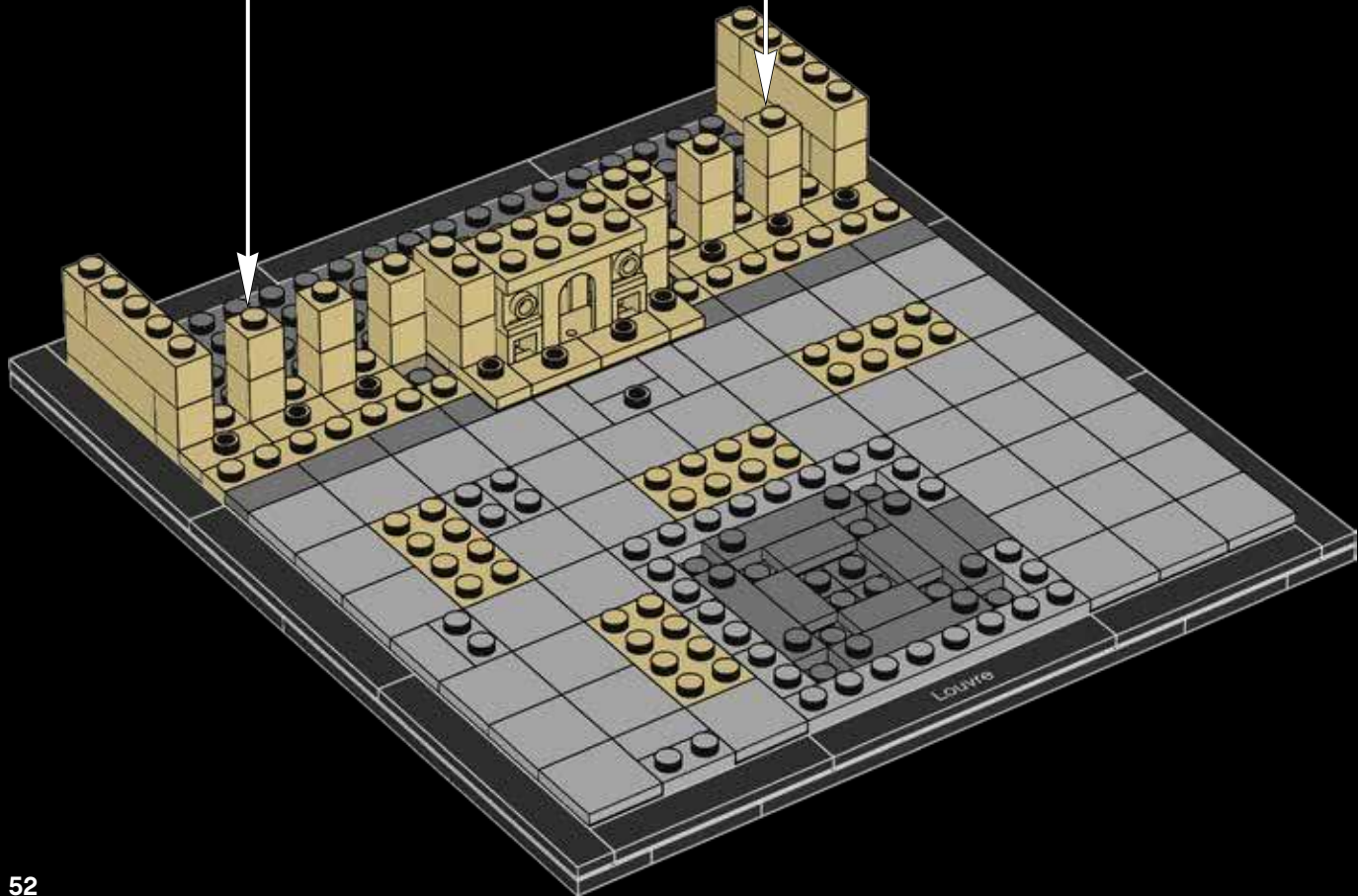



29

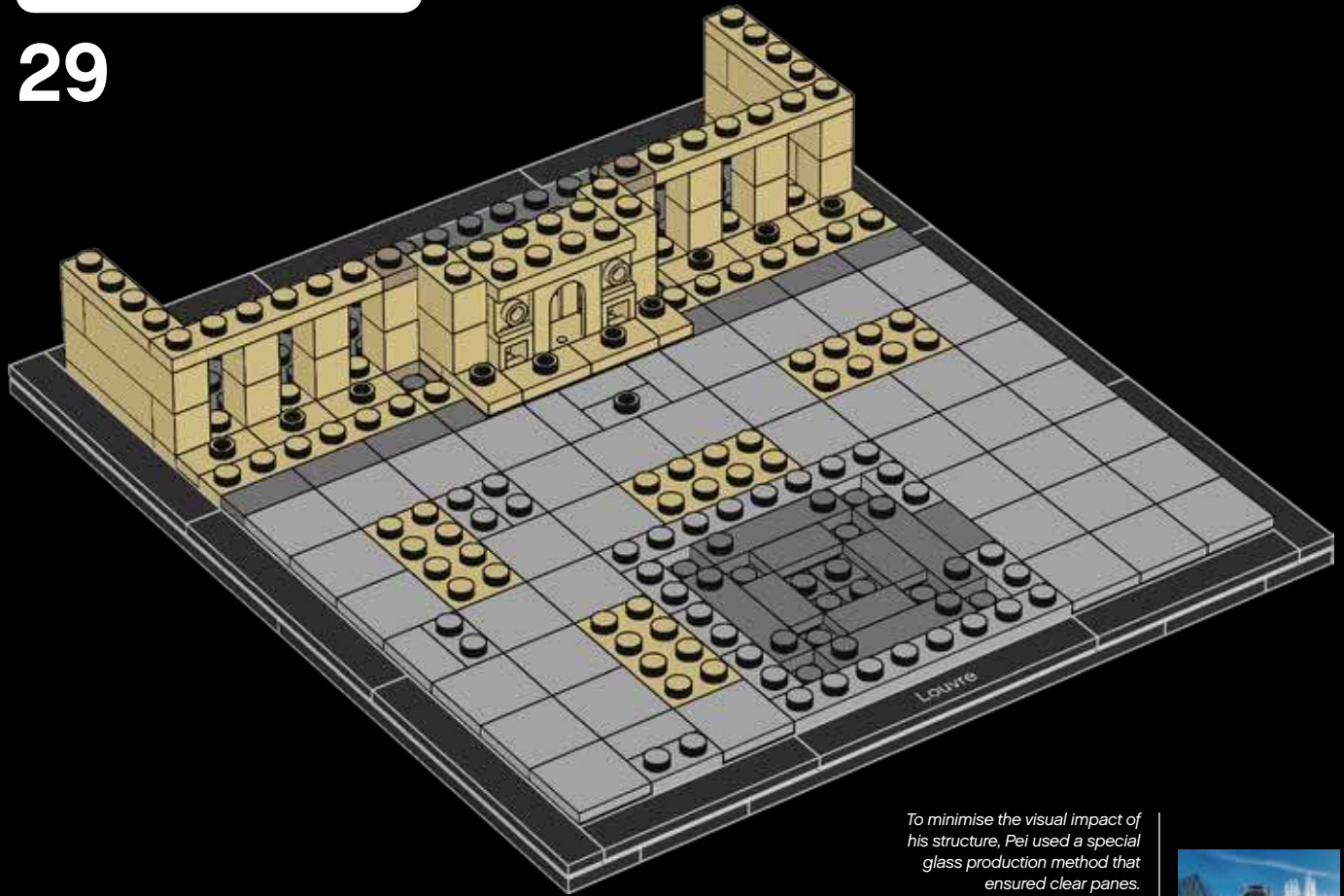

To minimise the visual impact of his structure, Pei used a special glass production method that ensured clear panes.

Pour limiter autant que possible l'impact visuel de sa structure, Pei a utilisé une méthode de production spéciale permettant d'assurer la transparence du verre.





6x



8x

# 30

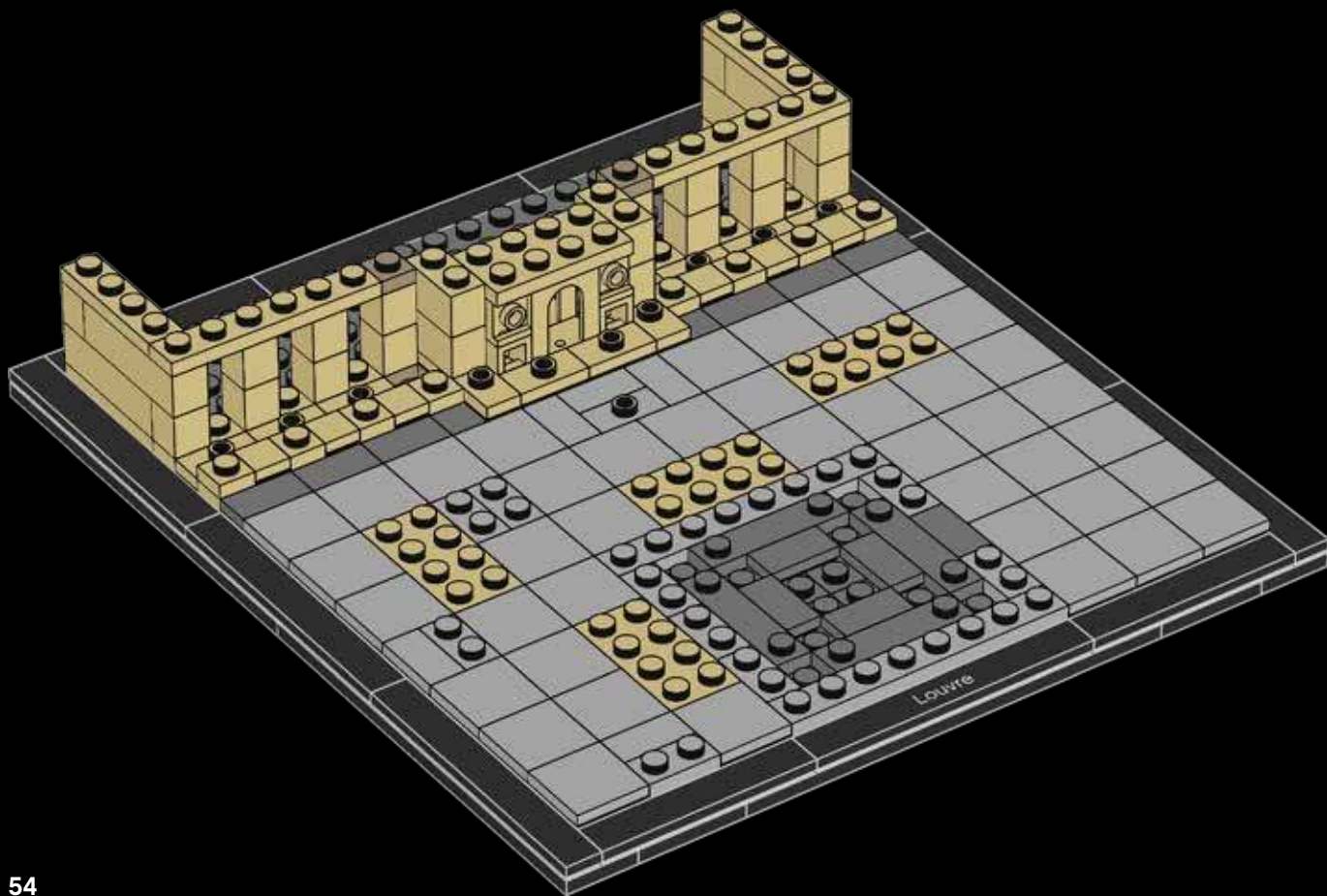

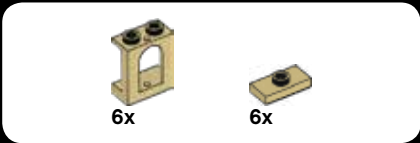

31

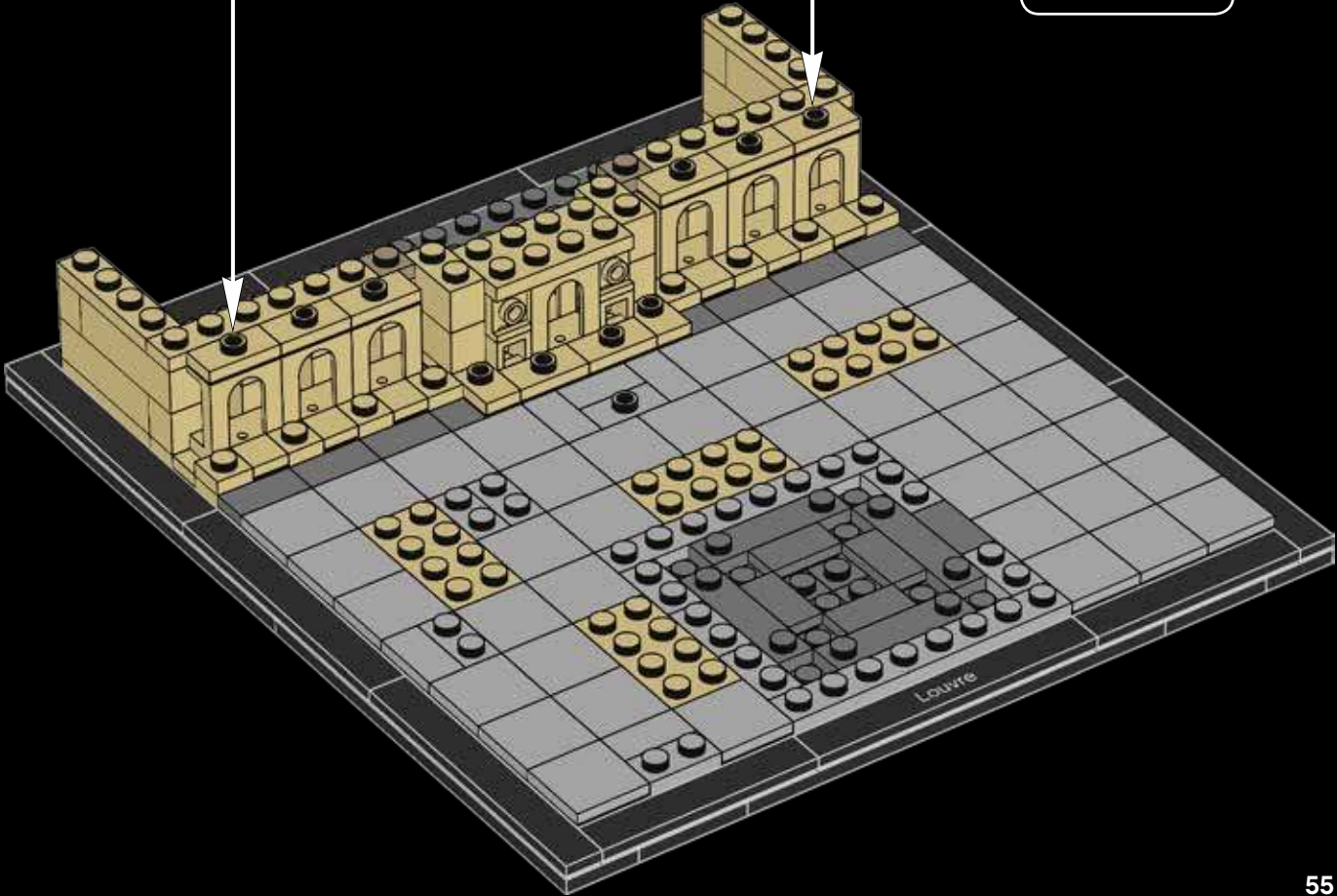
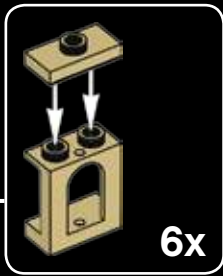

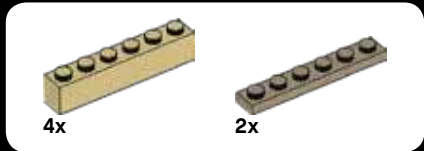

32

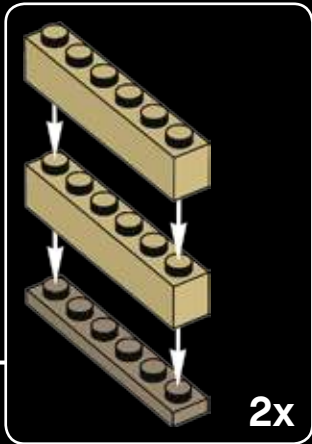
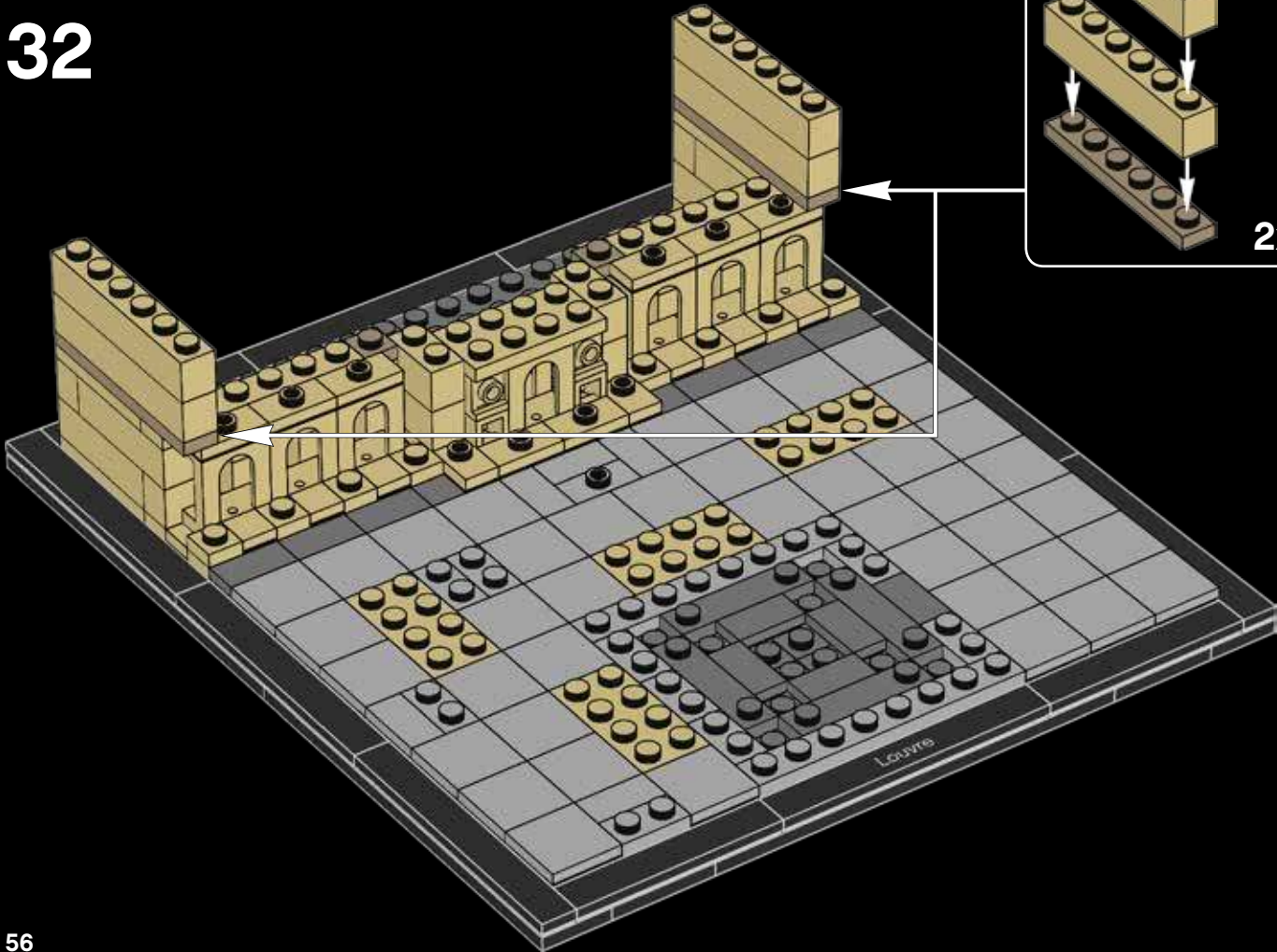



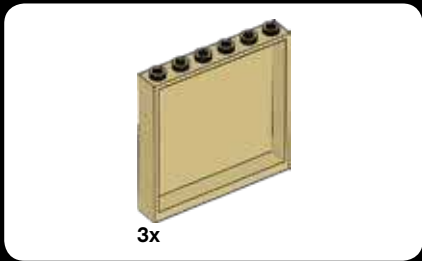

33

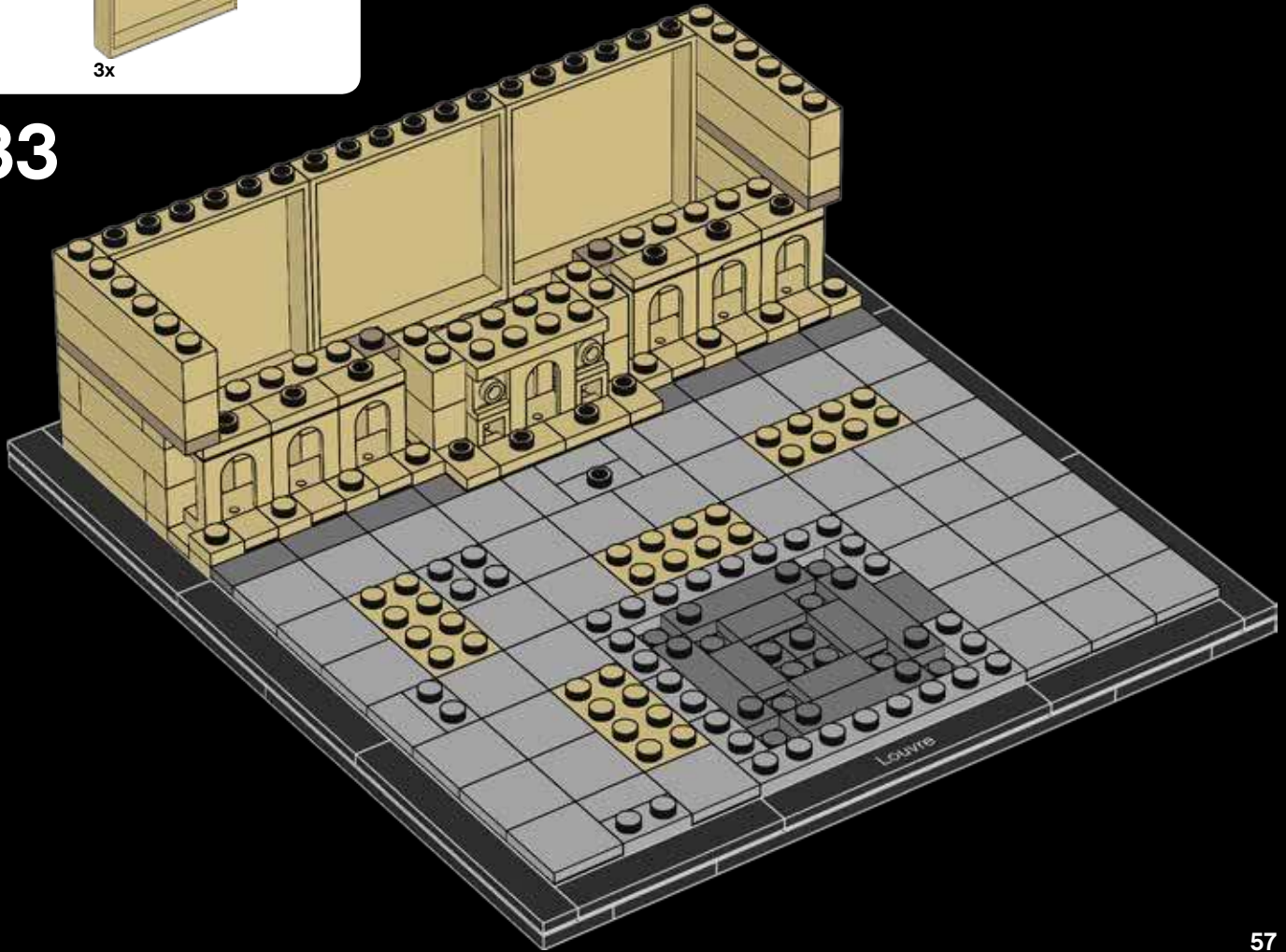



2x



2x

# 34

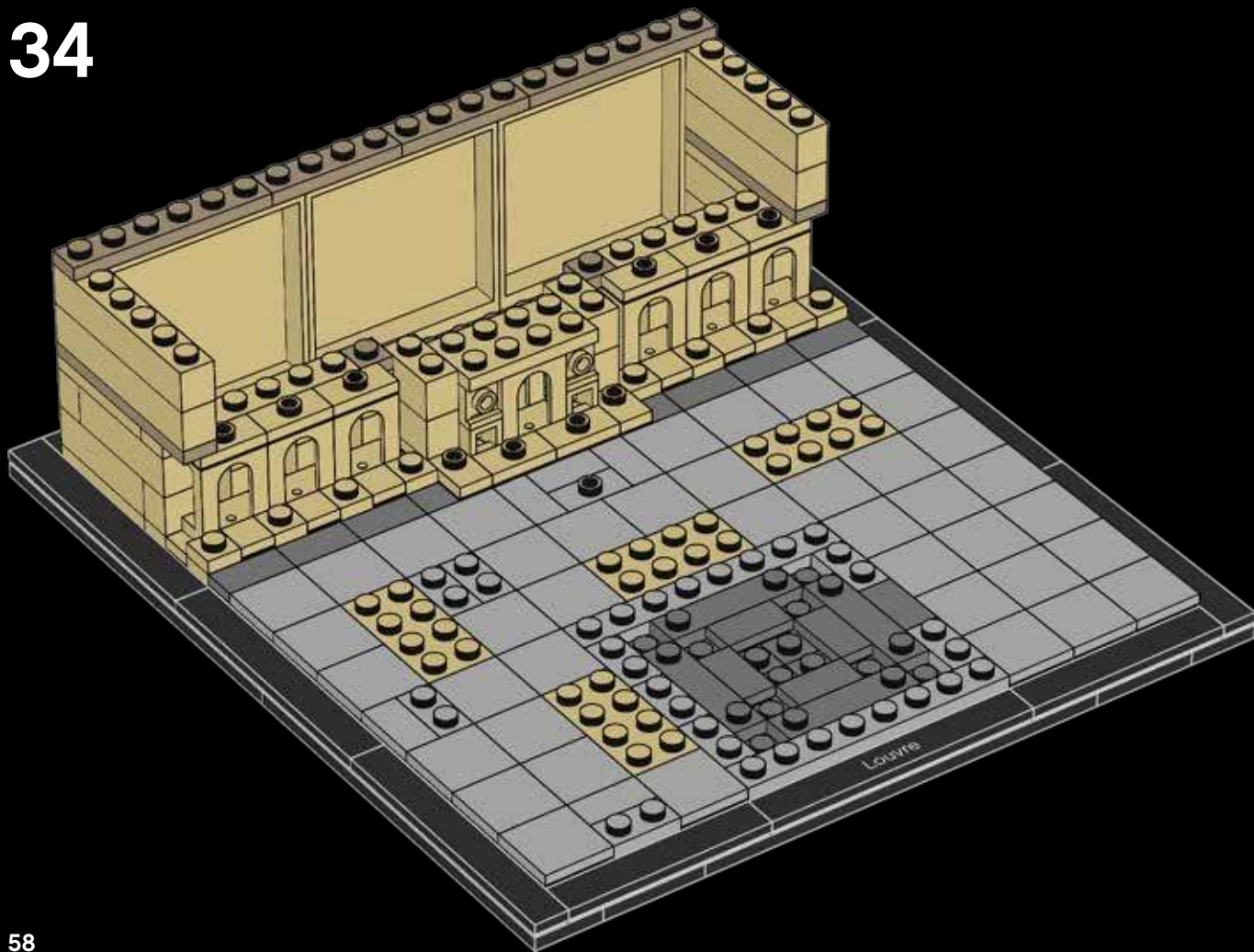



12x



6x

35

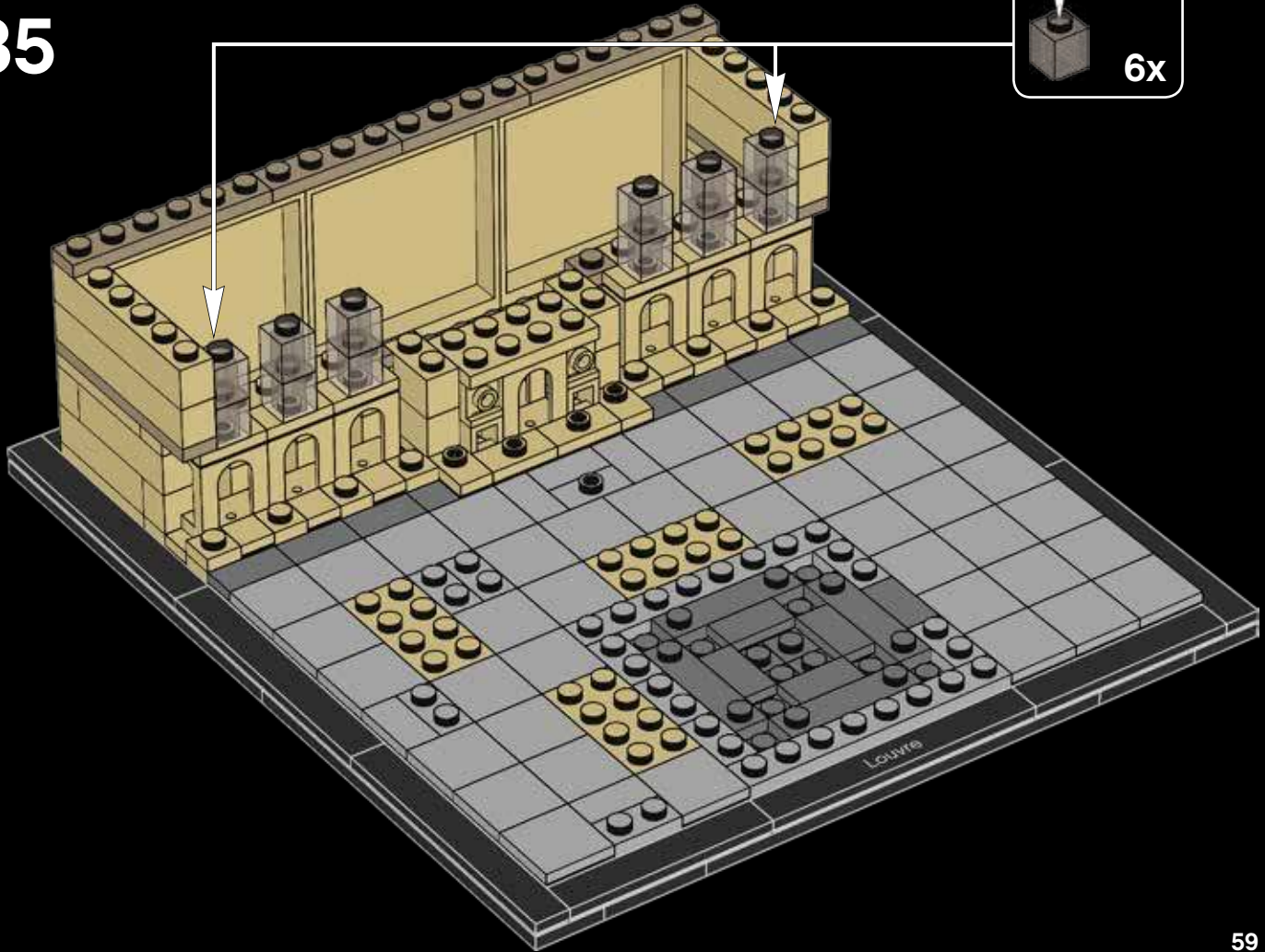



8x

36

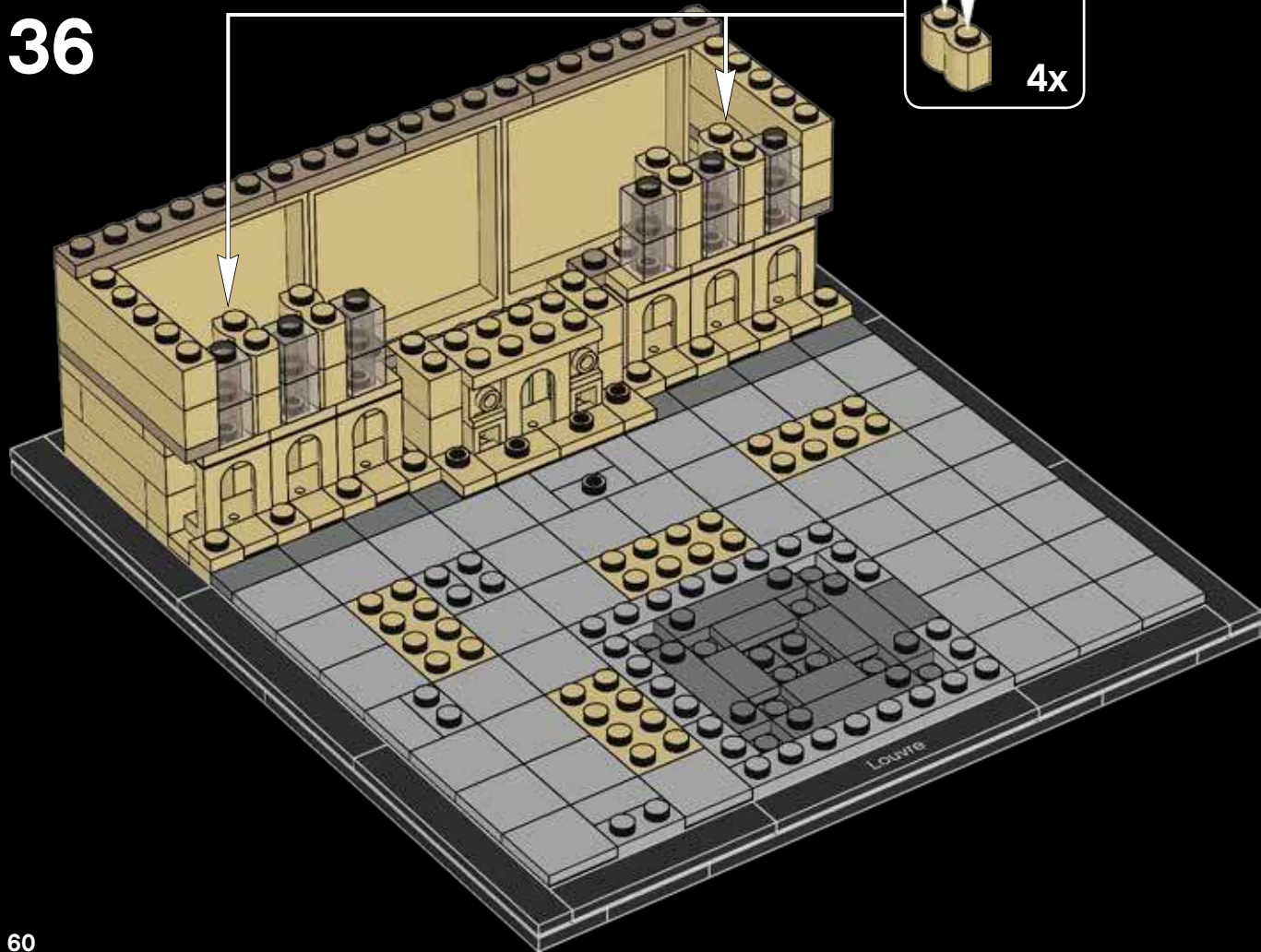

4x



37

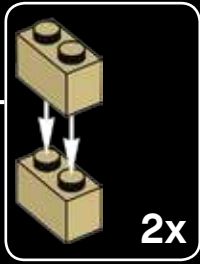
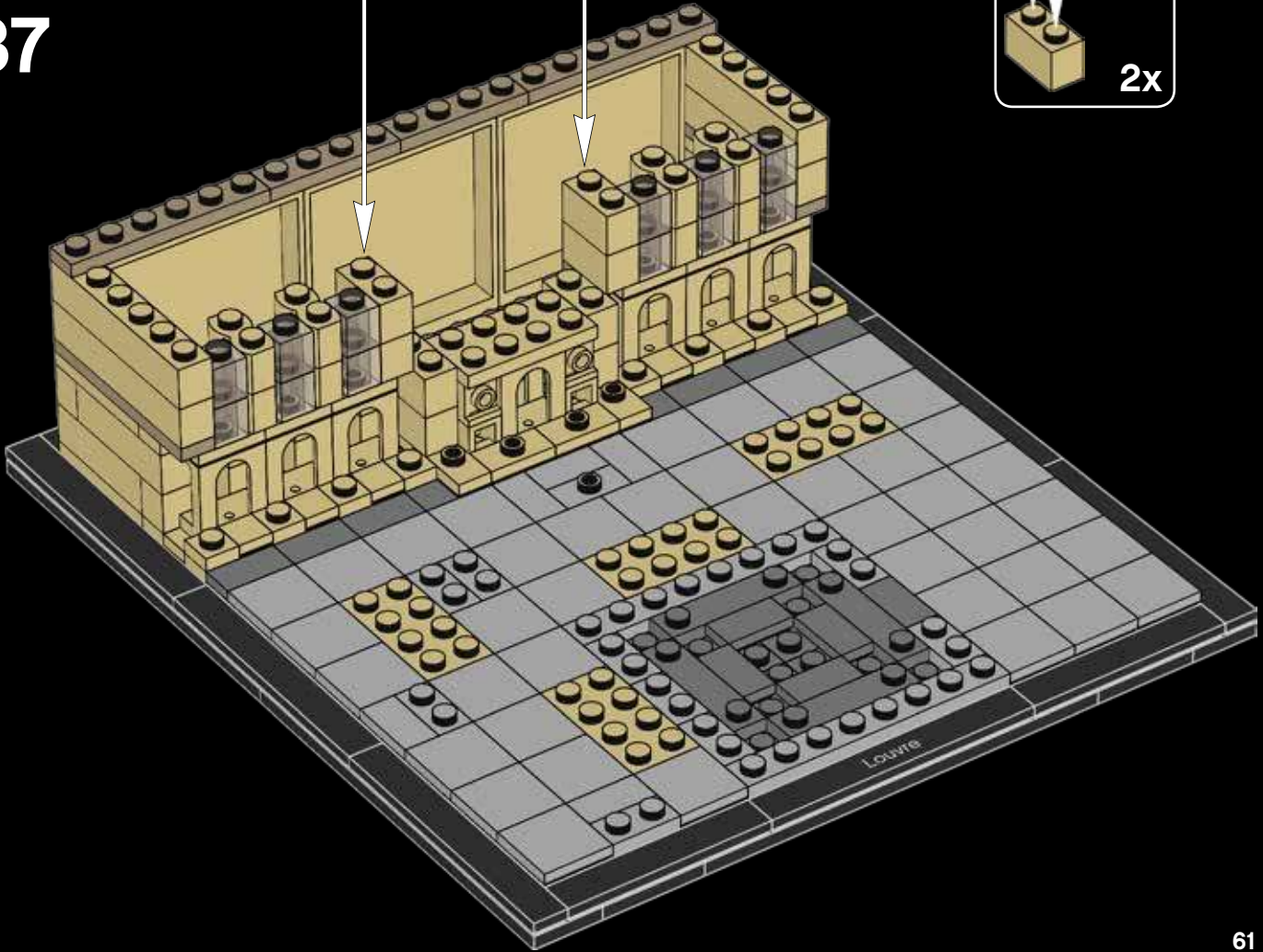



10x



10x

# 38



10x

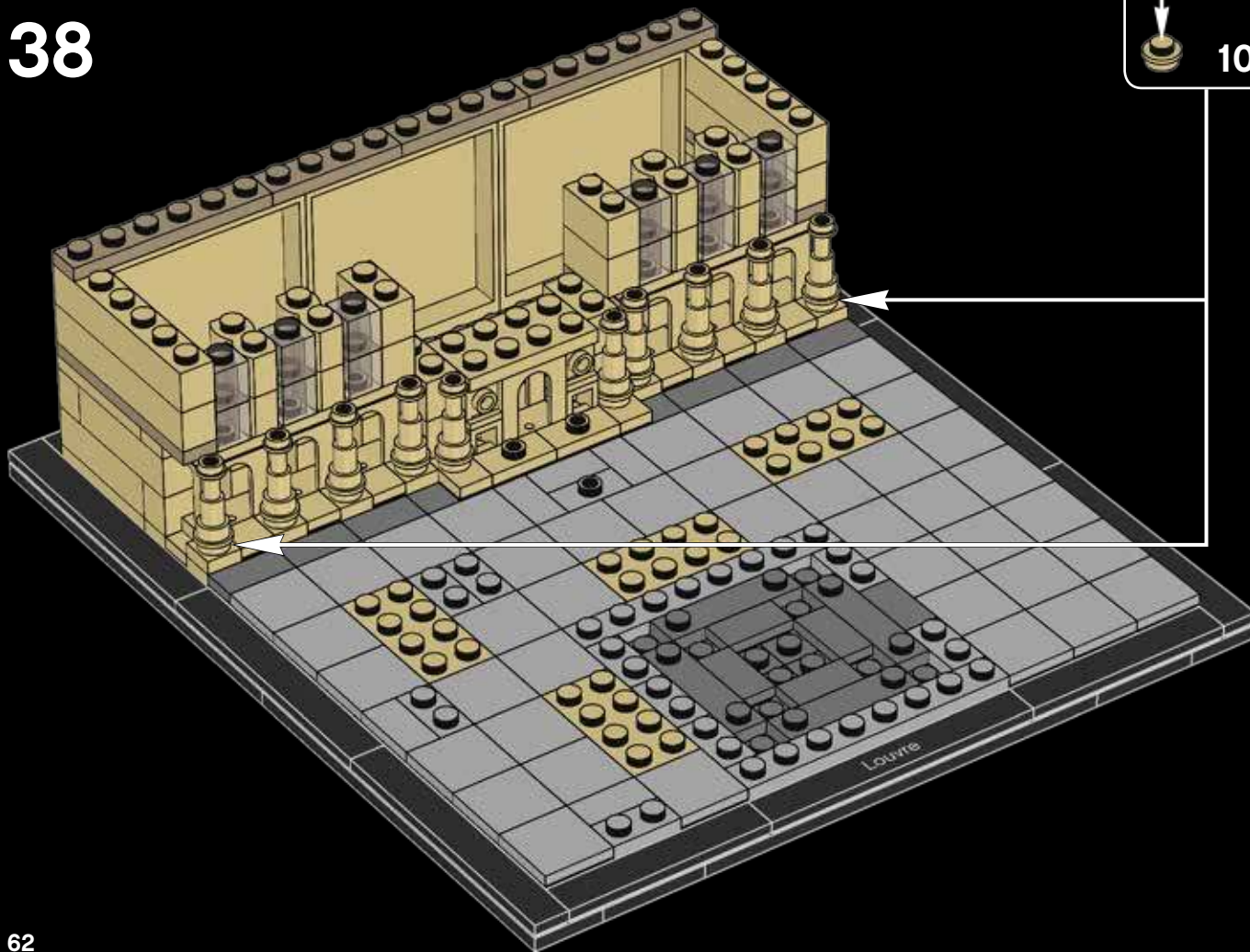

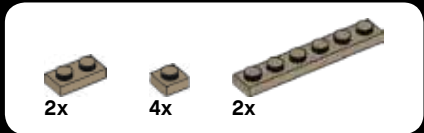

39

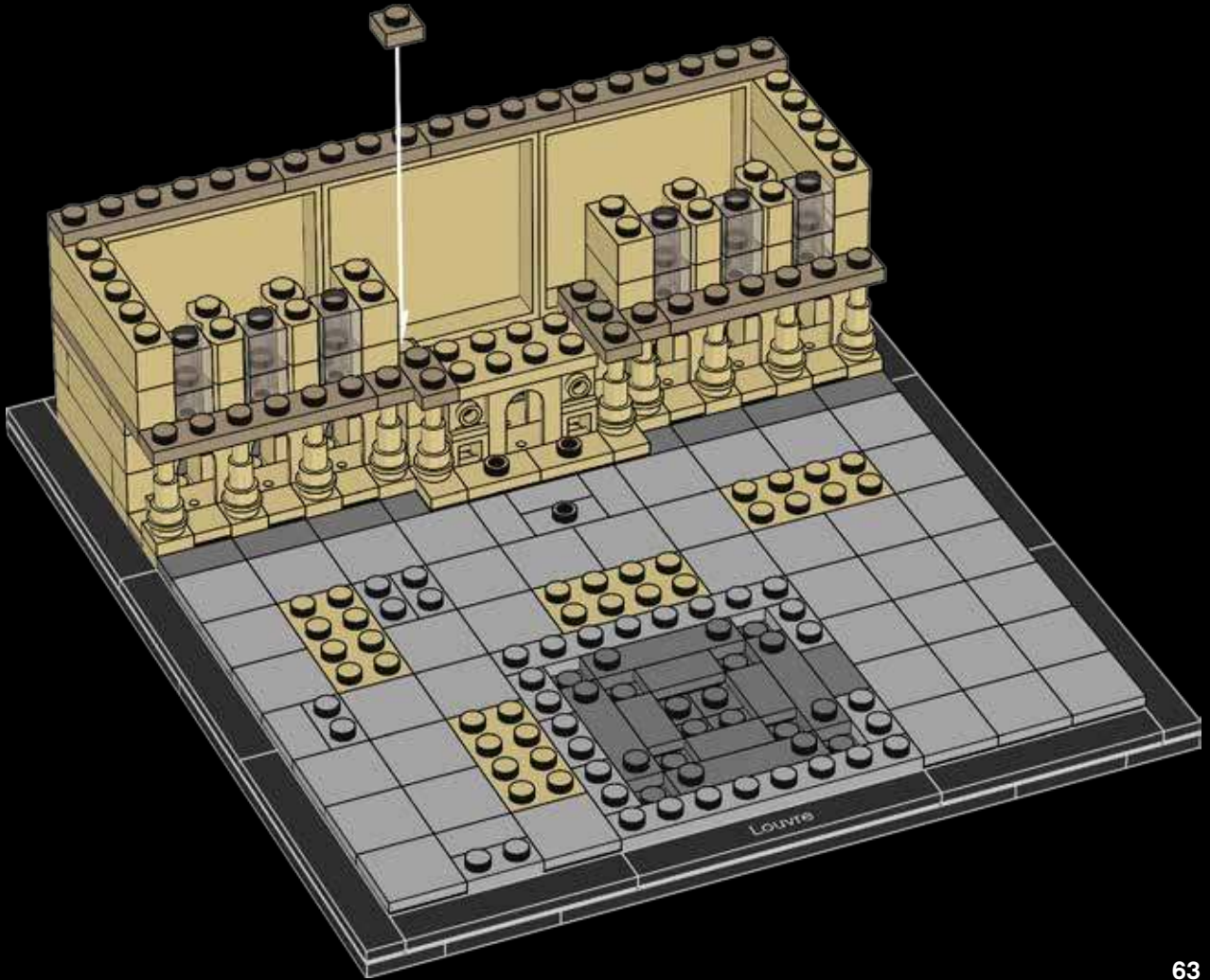



40

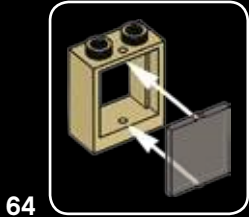
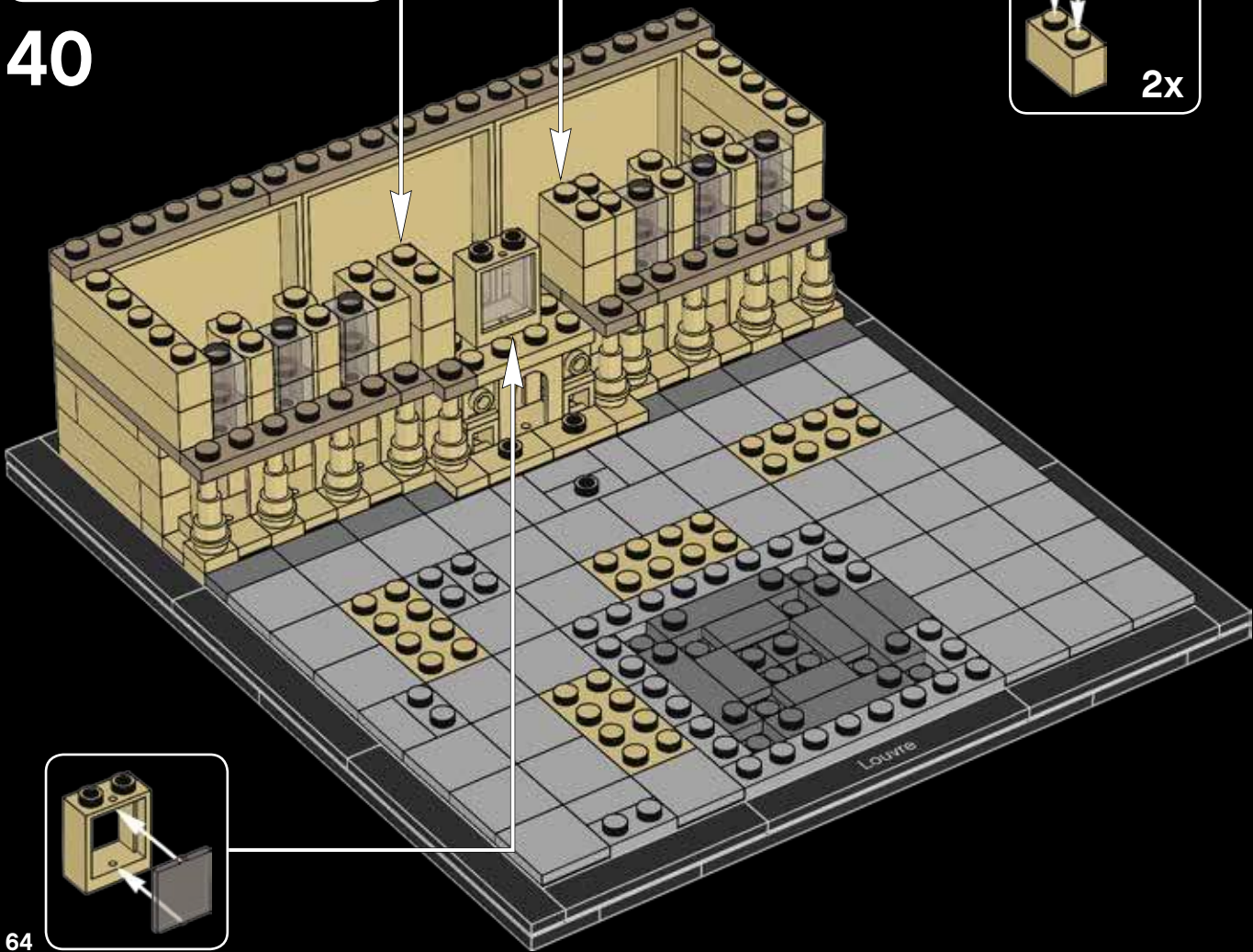
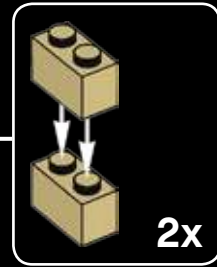





41

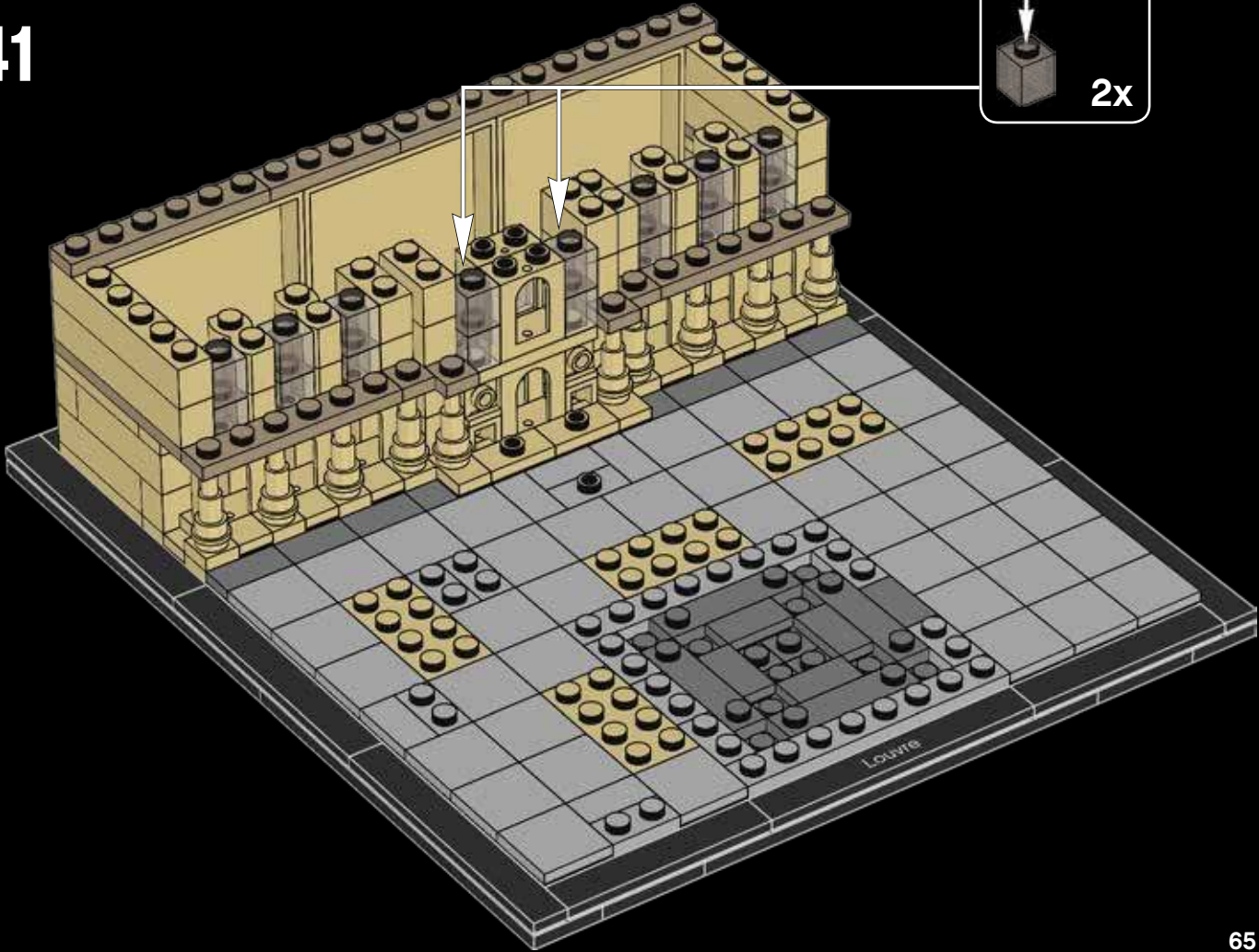
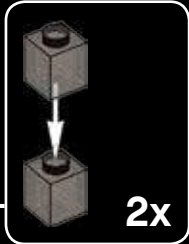



2x



1x

42

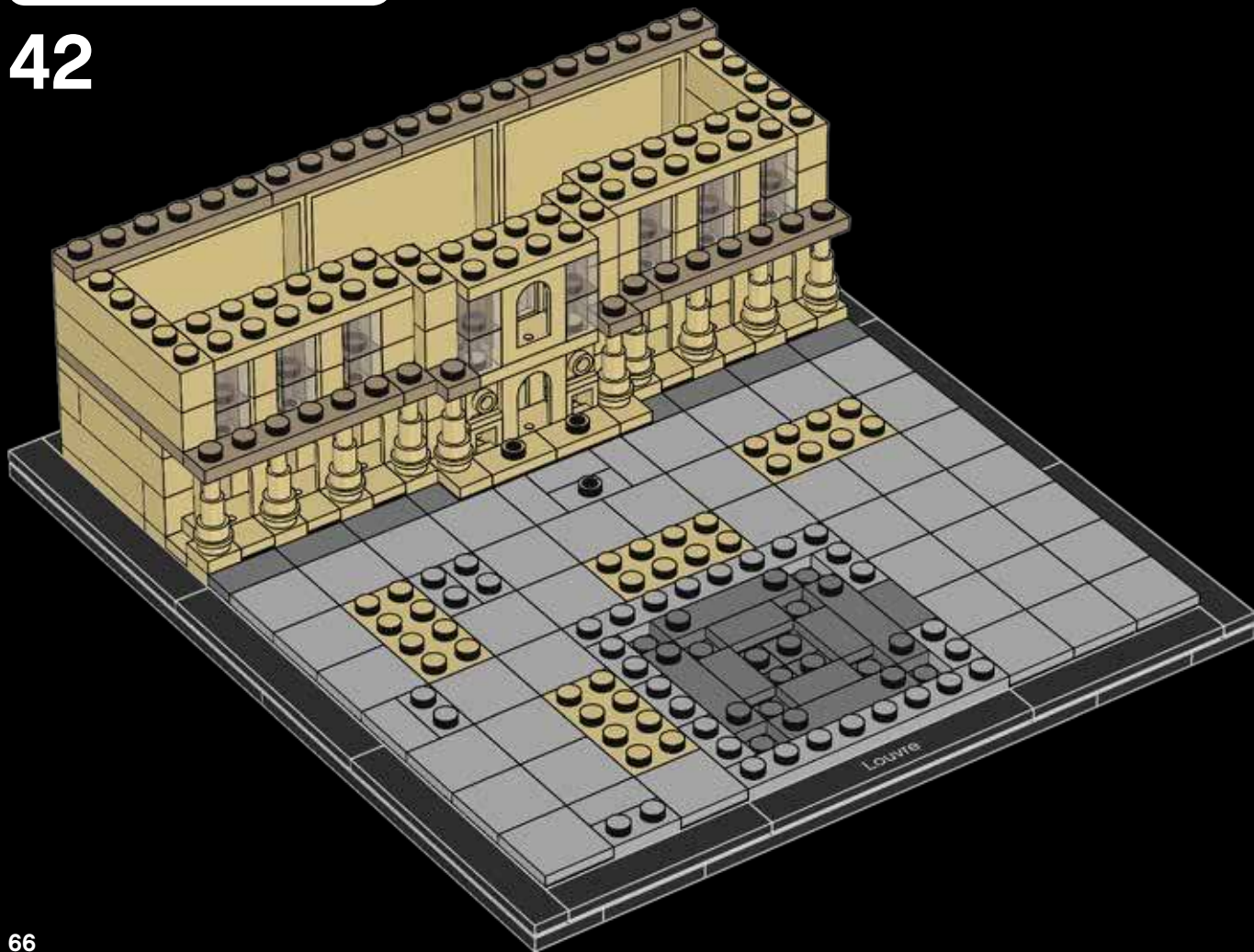



2x



2x



2x

# 43

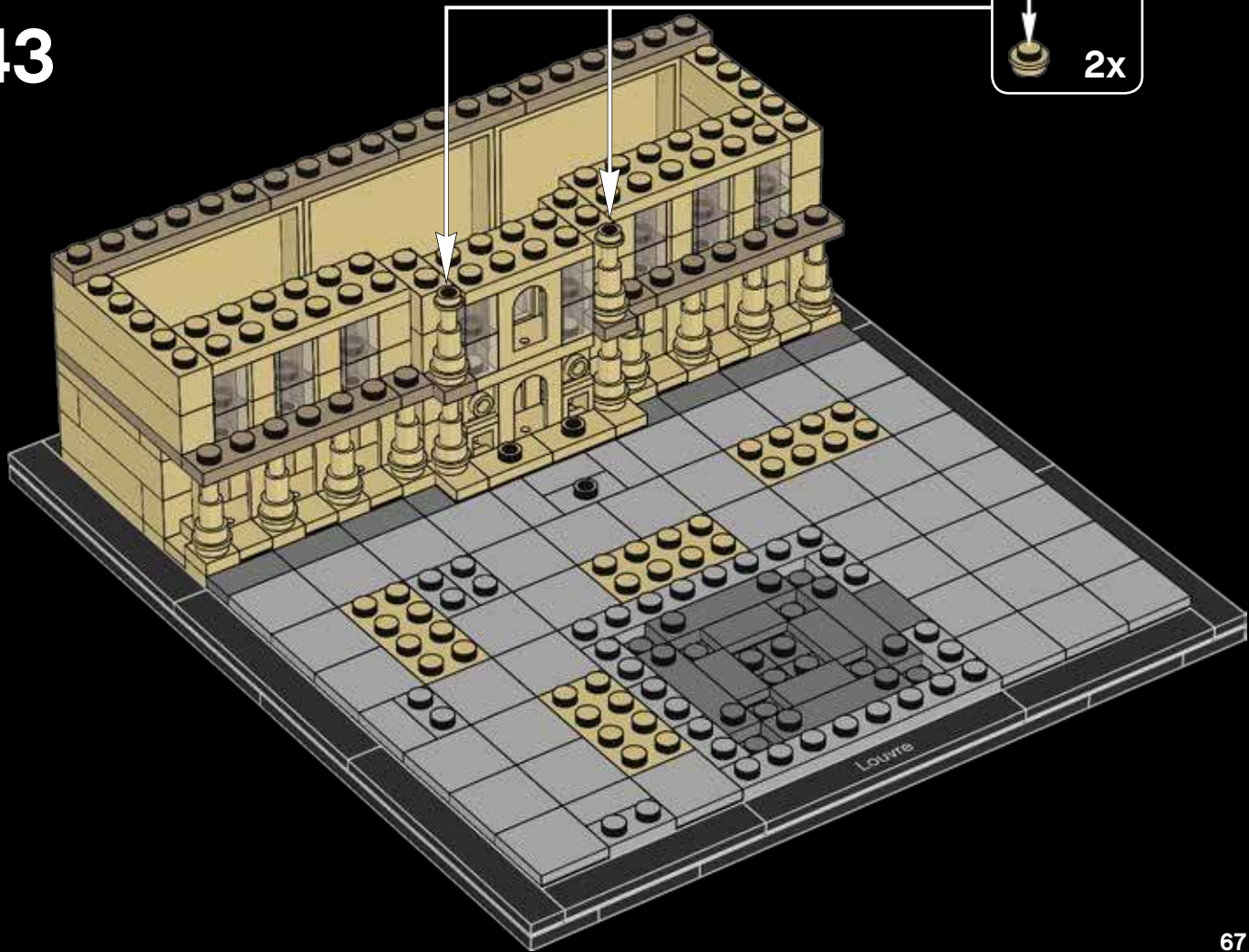

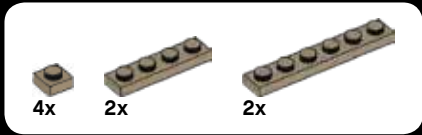

44

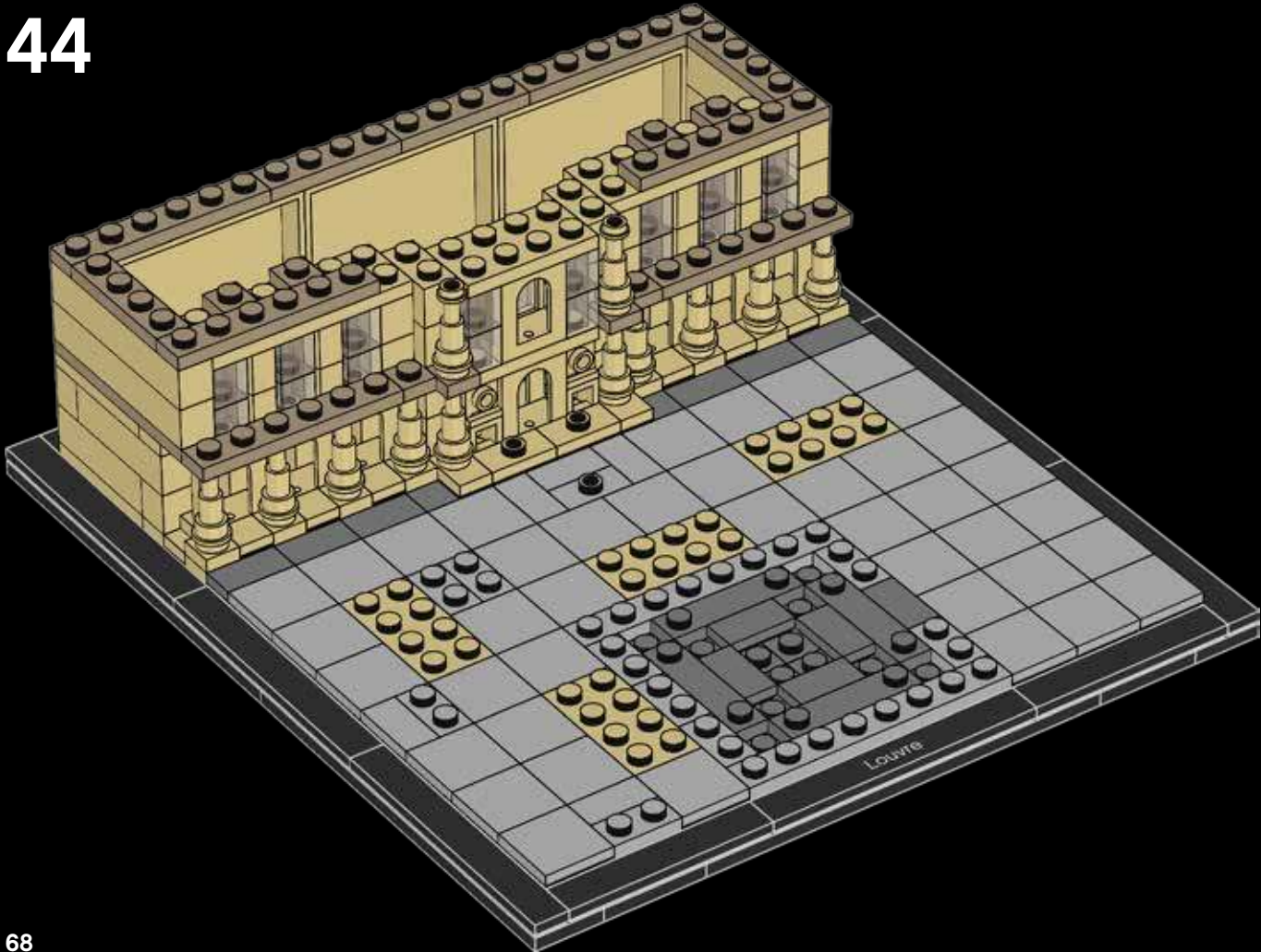



1x



3x



4x

# 45

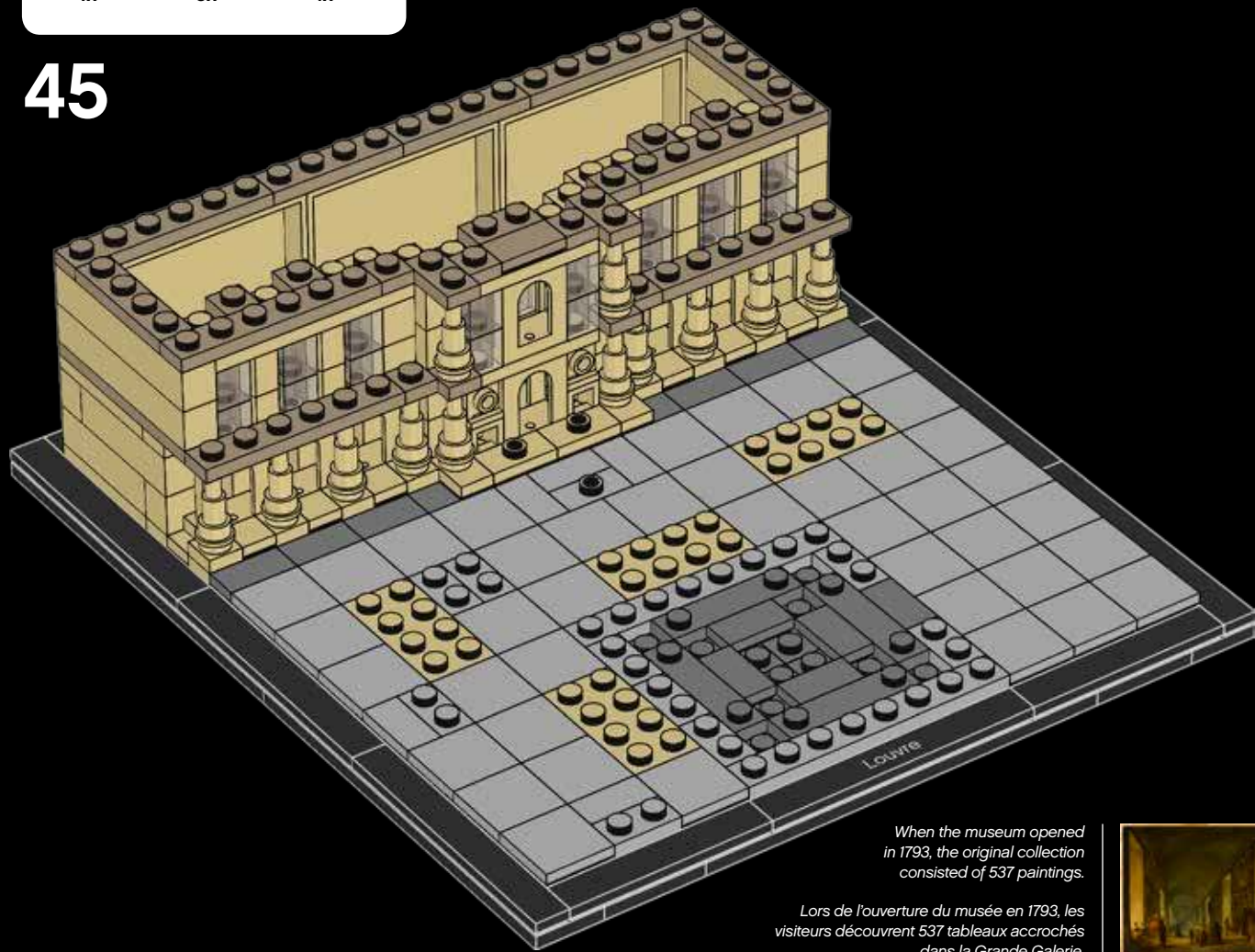

*When the museum opened in 1793, the original collection consisted of 537 paintings.*

*Lors de l'ouverture du musée en 1793, les visiteurs découvrent 537 tableaux accrochés dans la Grande Galerie.*



*The Grand Gallery of the Louvre Museum between 1794 and 1796. Hubert Robert, FR 1948-36/La Grande Galerie du Louvre entre 1794 et 1796. Hubert Robert, FR 1948-36 © Musée du Louvre, Dist. RMN/Stephane Mirechalle*



6x



4x



2x

# 46

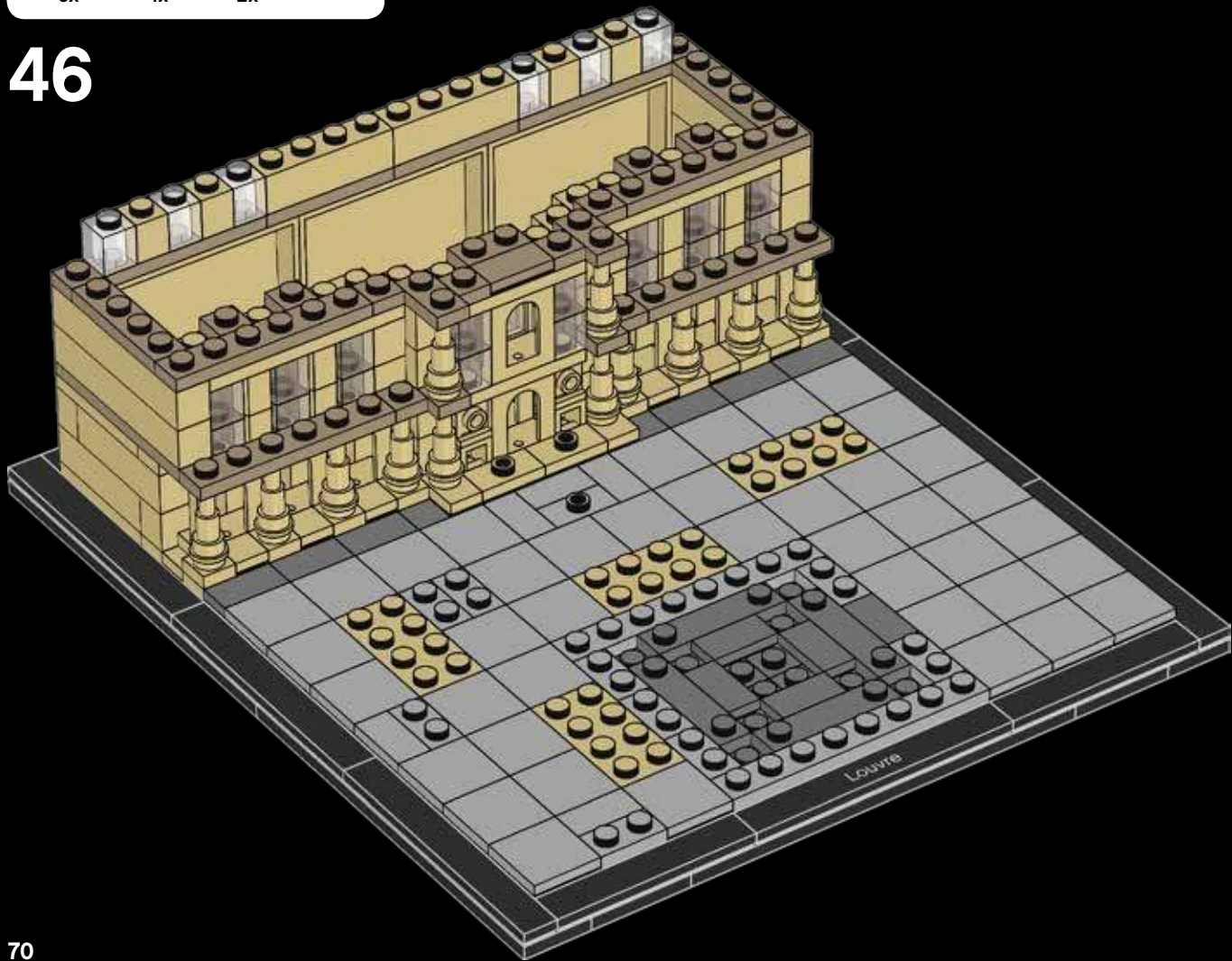



2x



2x

47

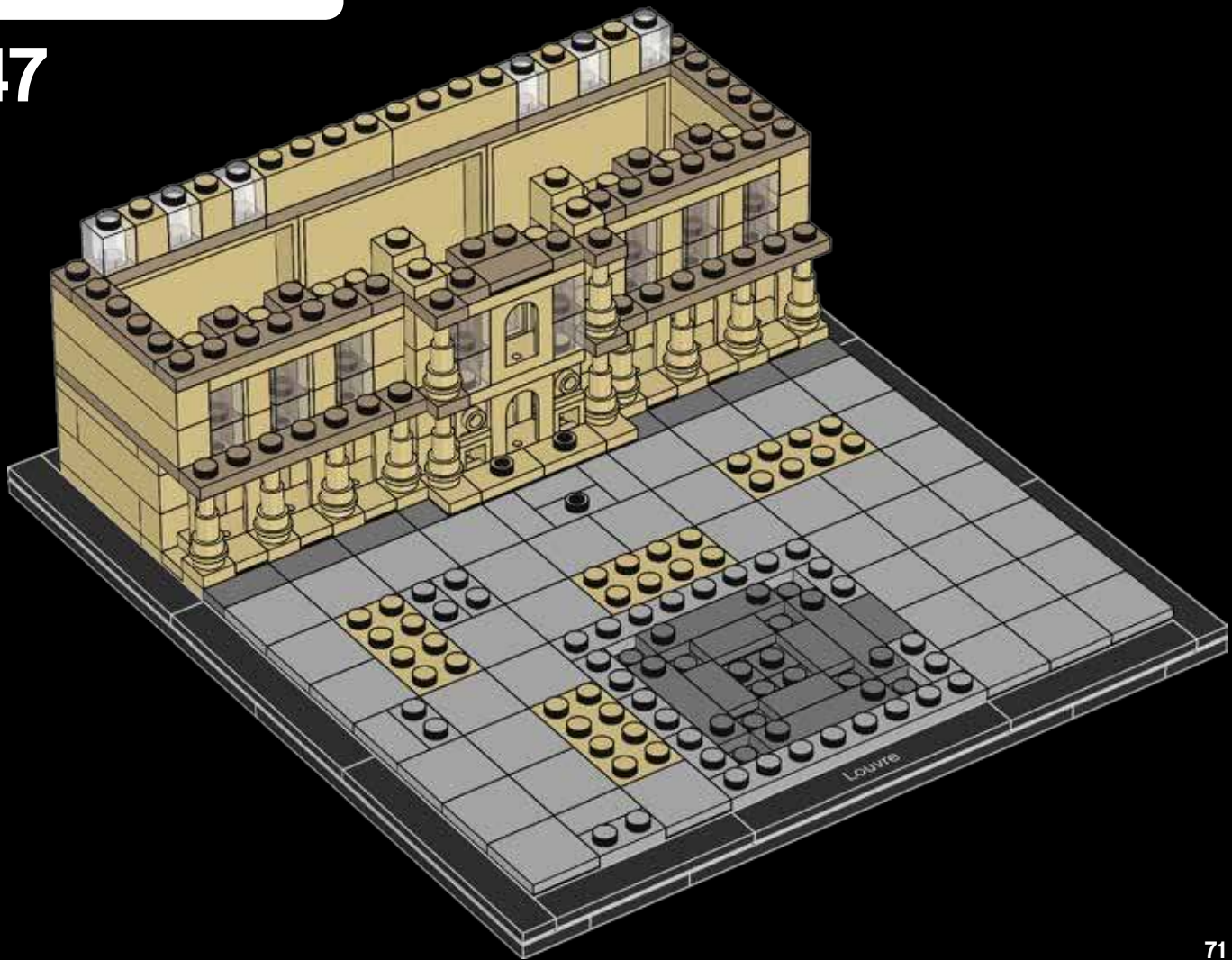



2x



2x

48

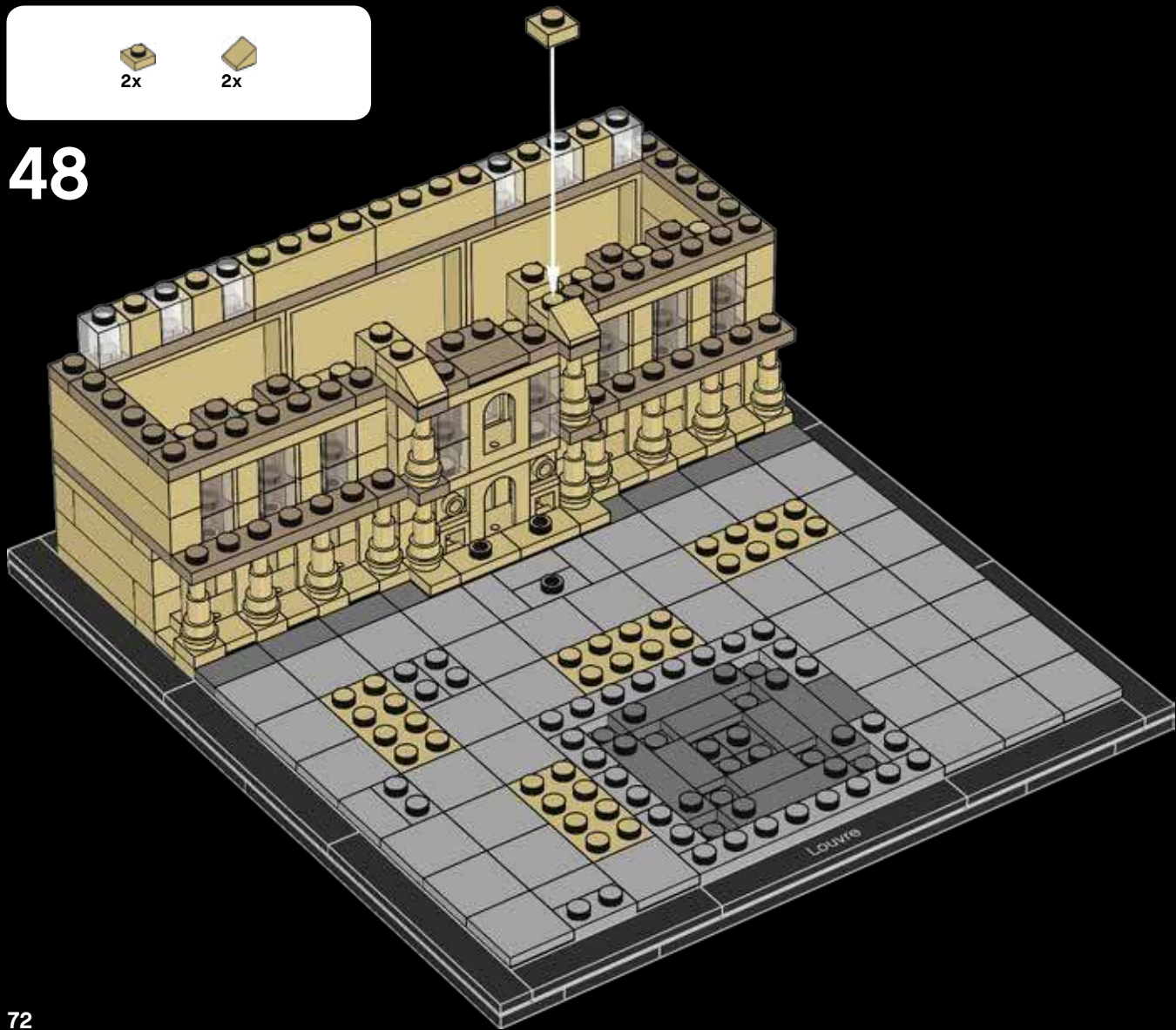



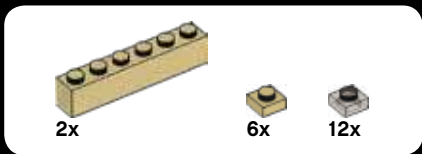

49





2x



2x



4x



2x

# 50

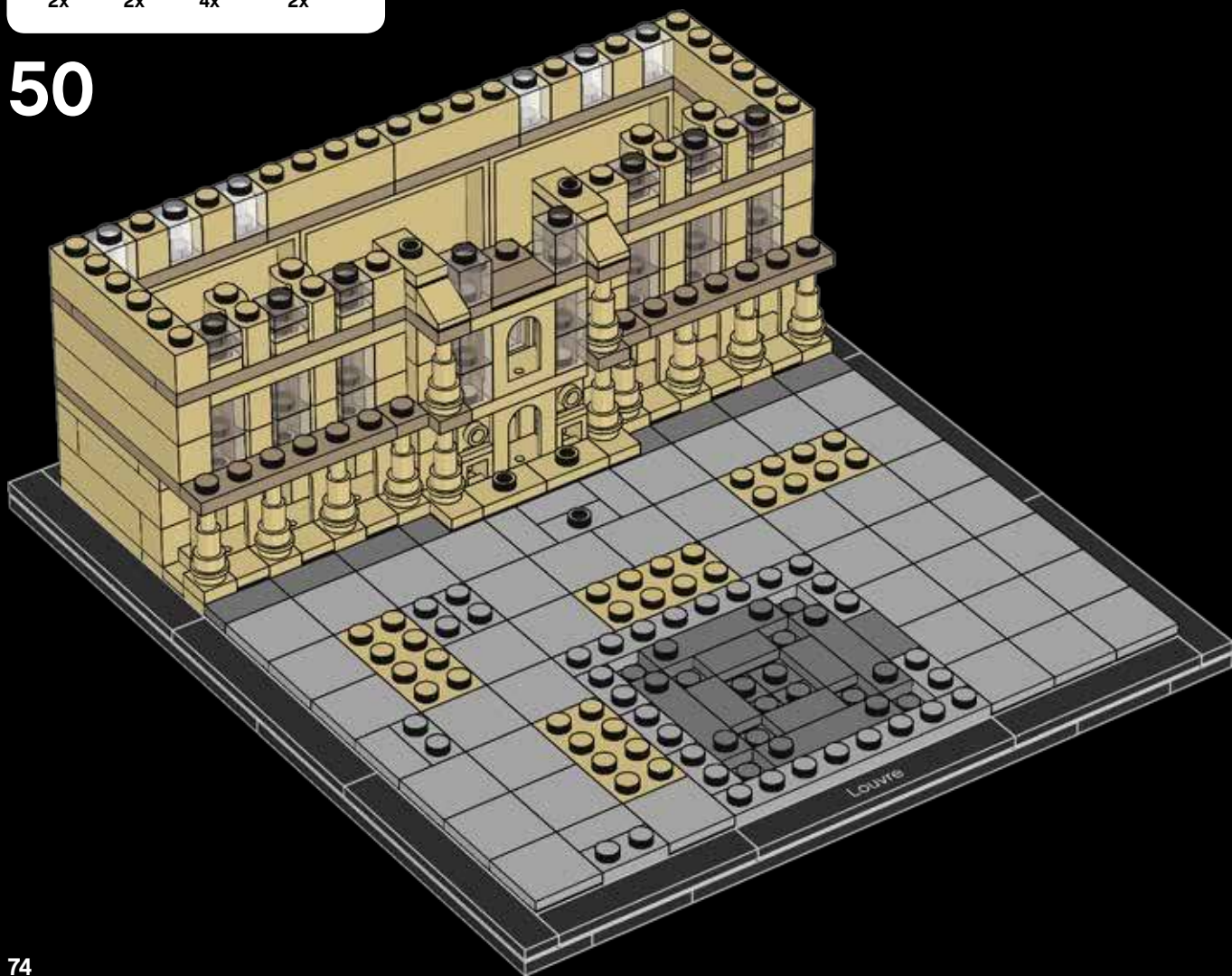



1x



1x



2x



1x

# 51

1

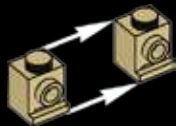

2



3

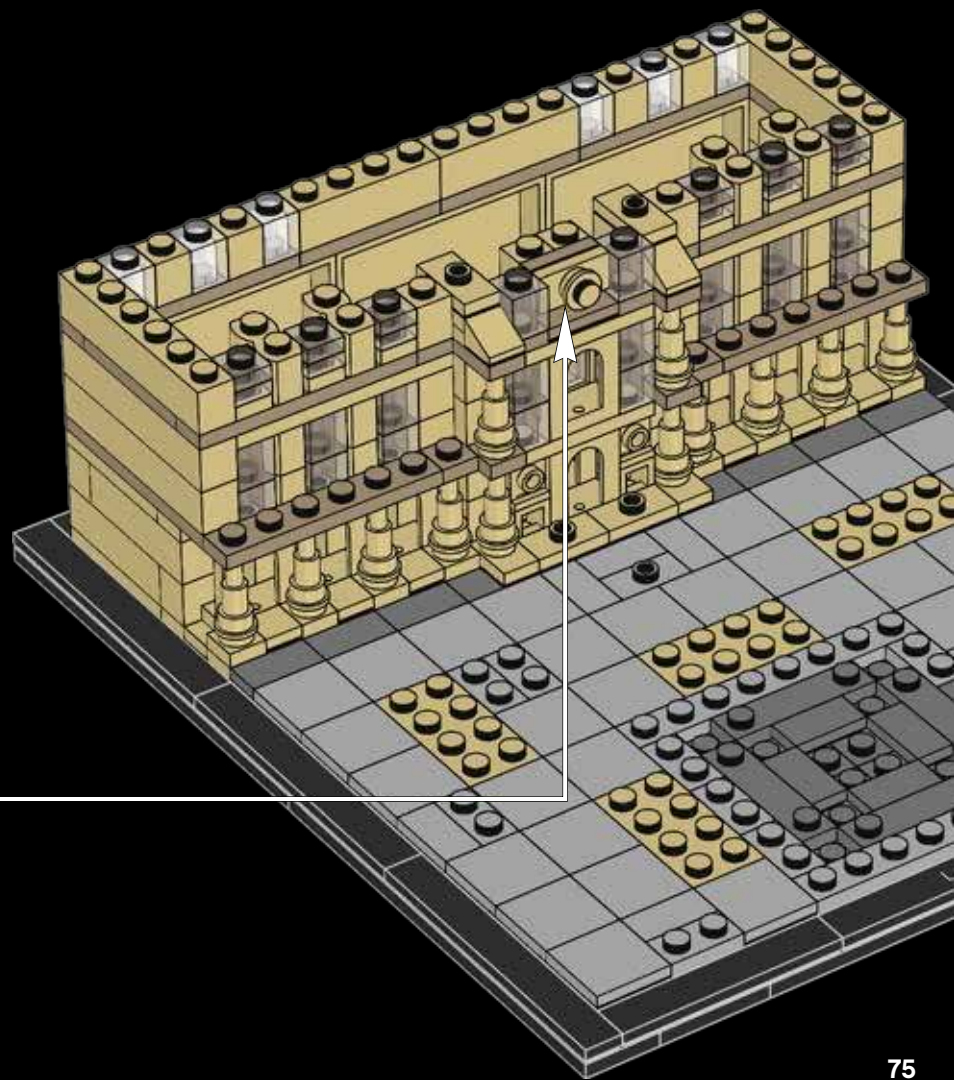
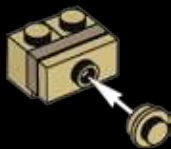

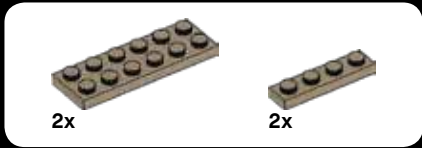

52

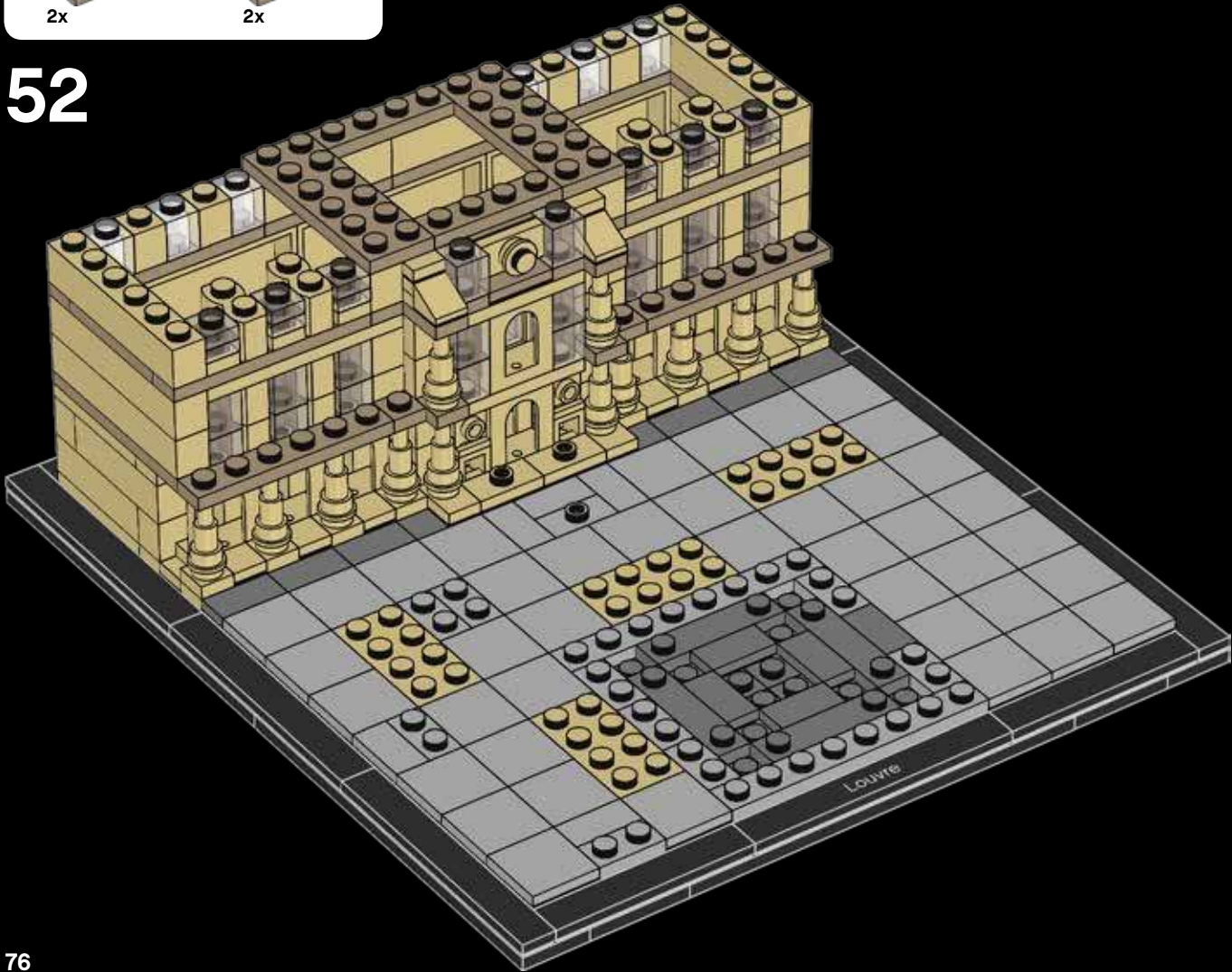



2x



2x

# 53

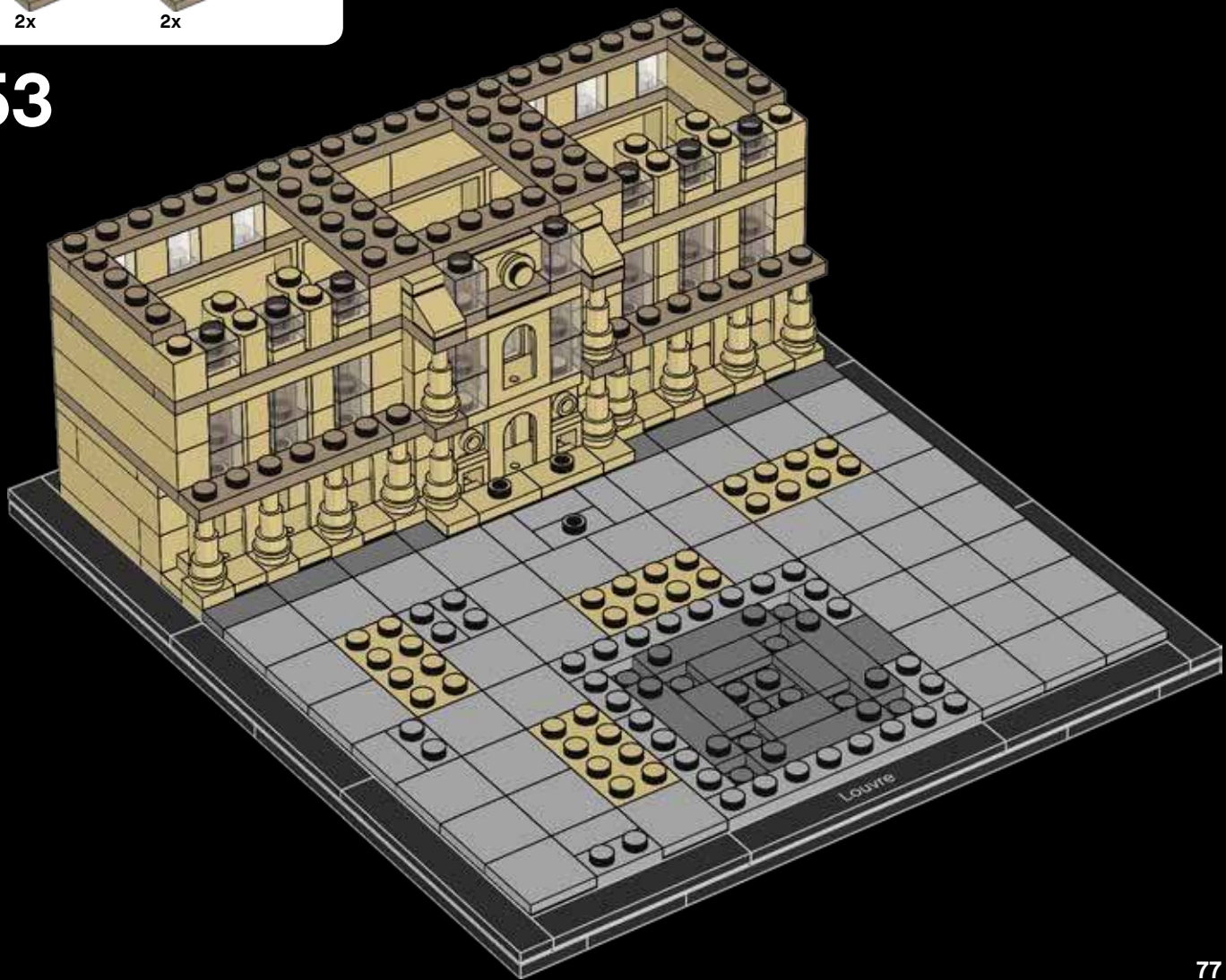



6x



1x

54





4x



4x



4x

# 55

## 1



## 2



## 3



# 2x

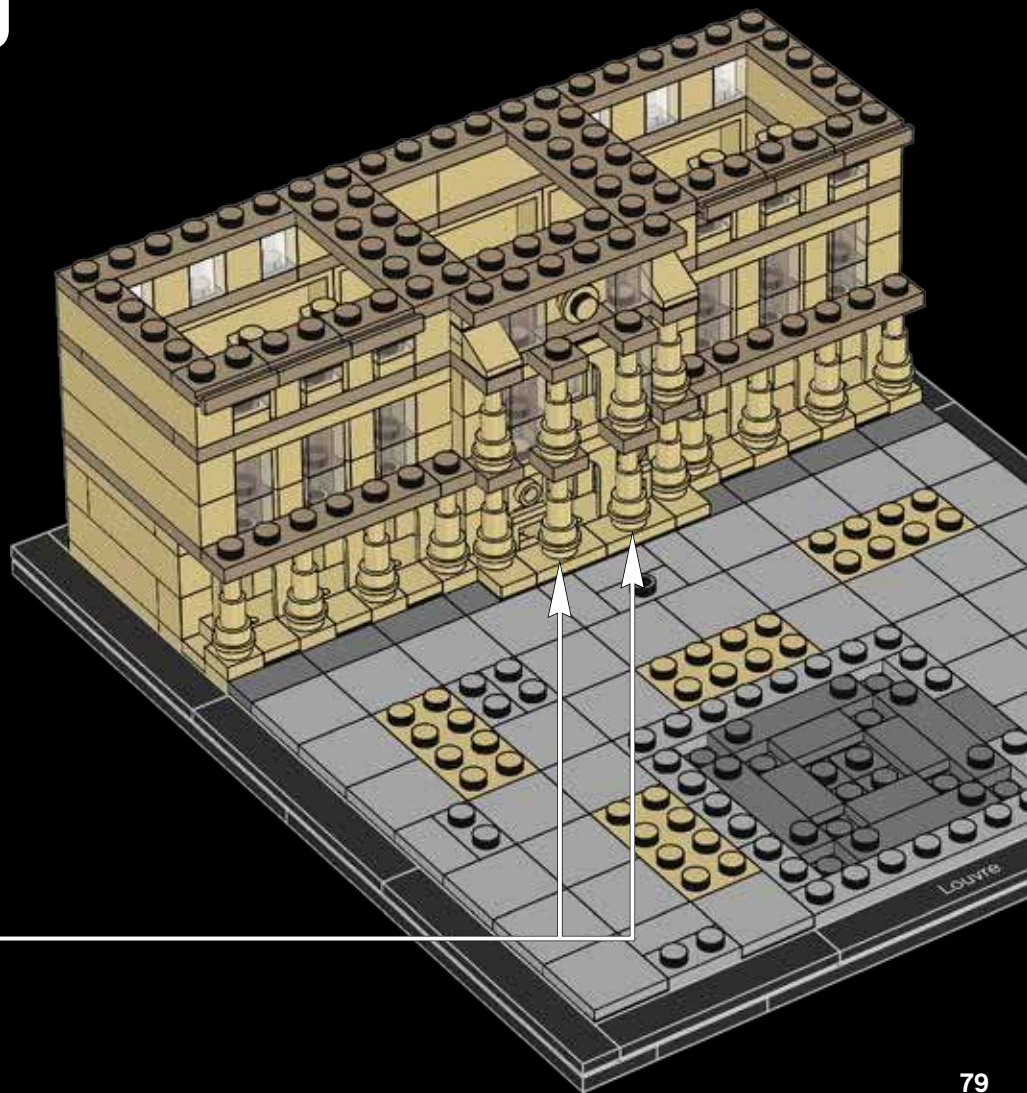



20x

56



10x

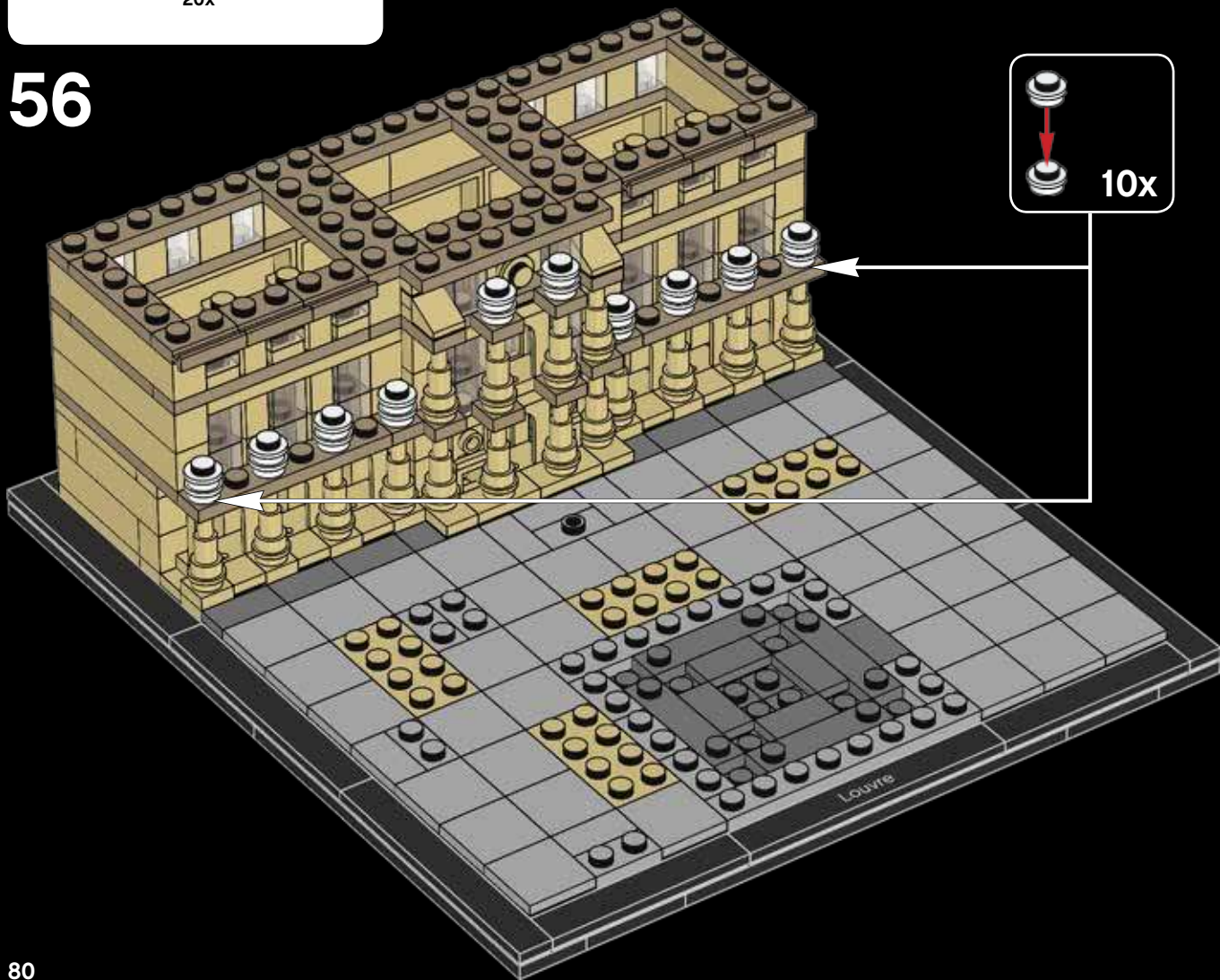





4x



2x

57

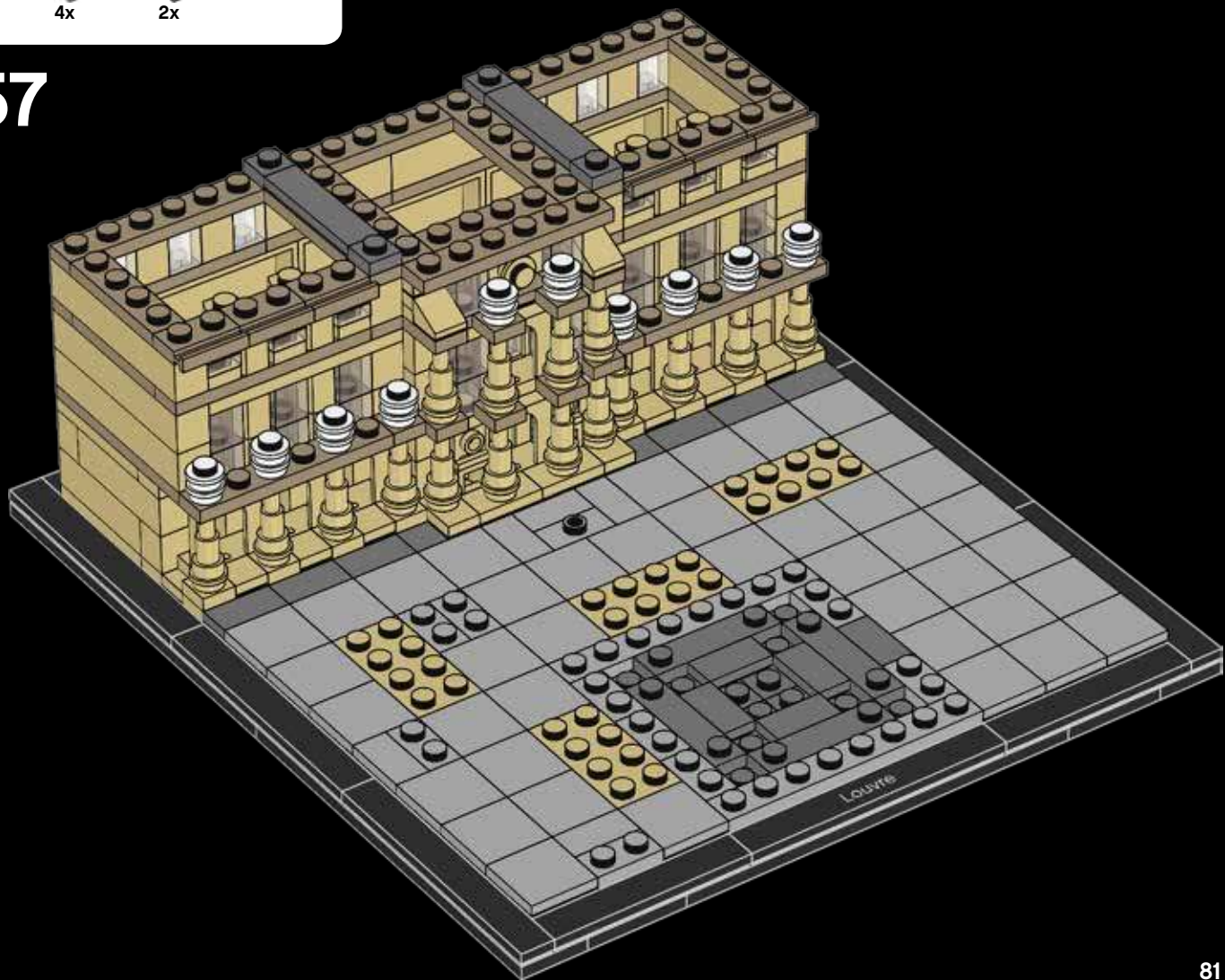



1x



2x

58

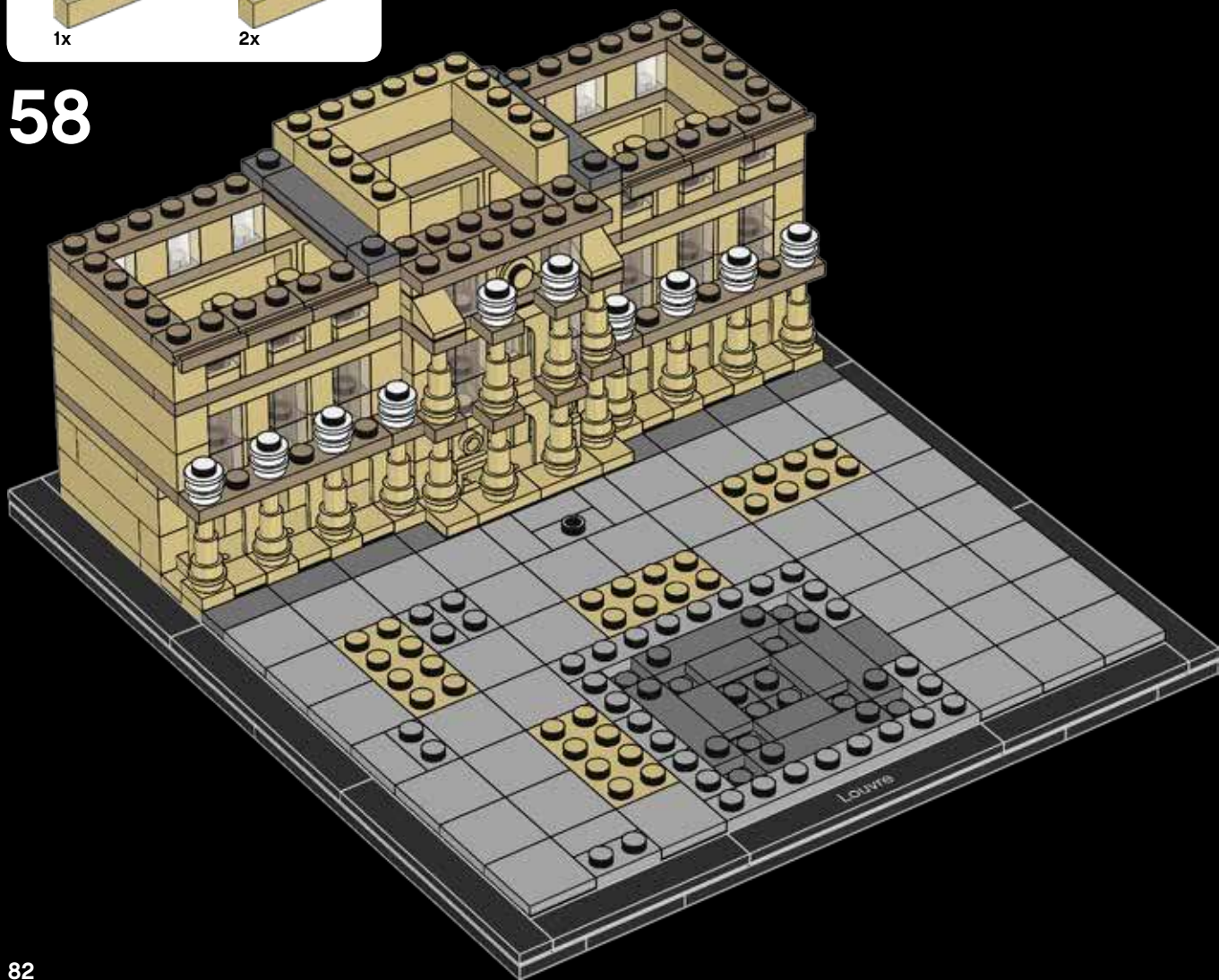

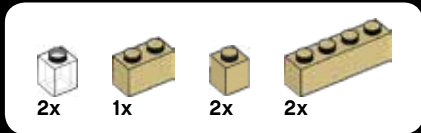

59



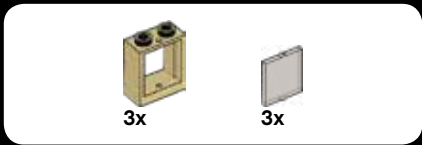

60

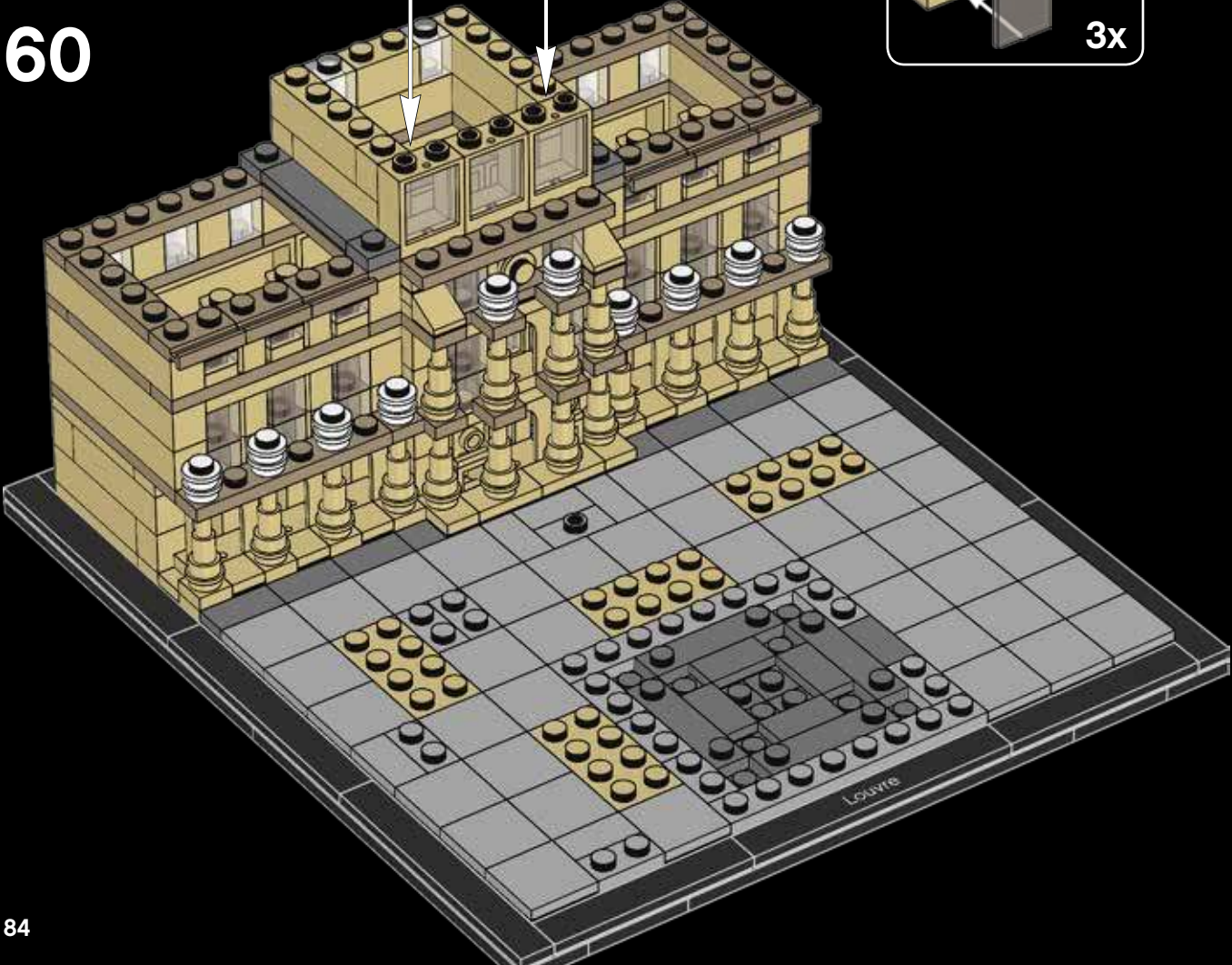
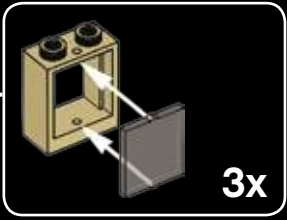



3x

61

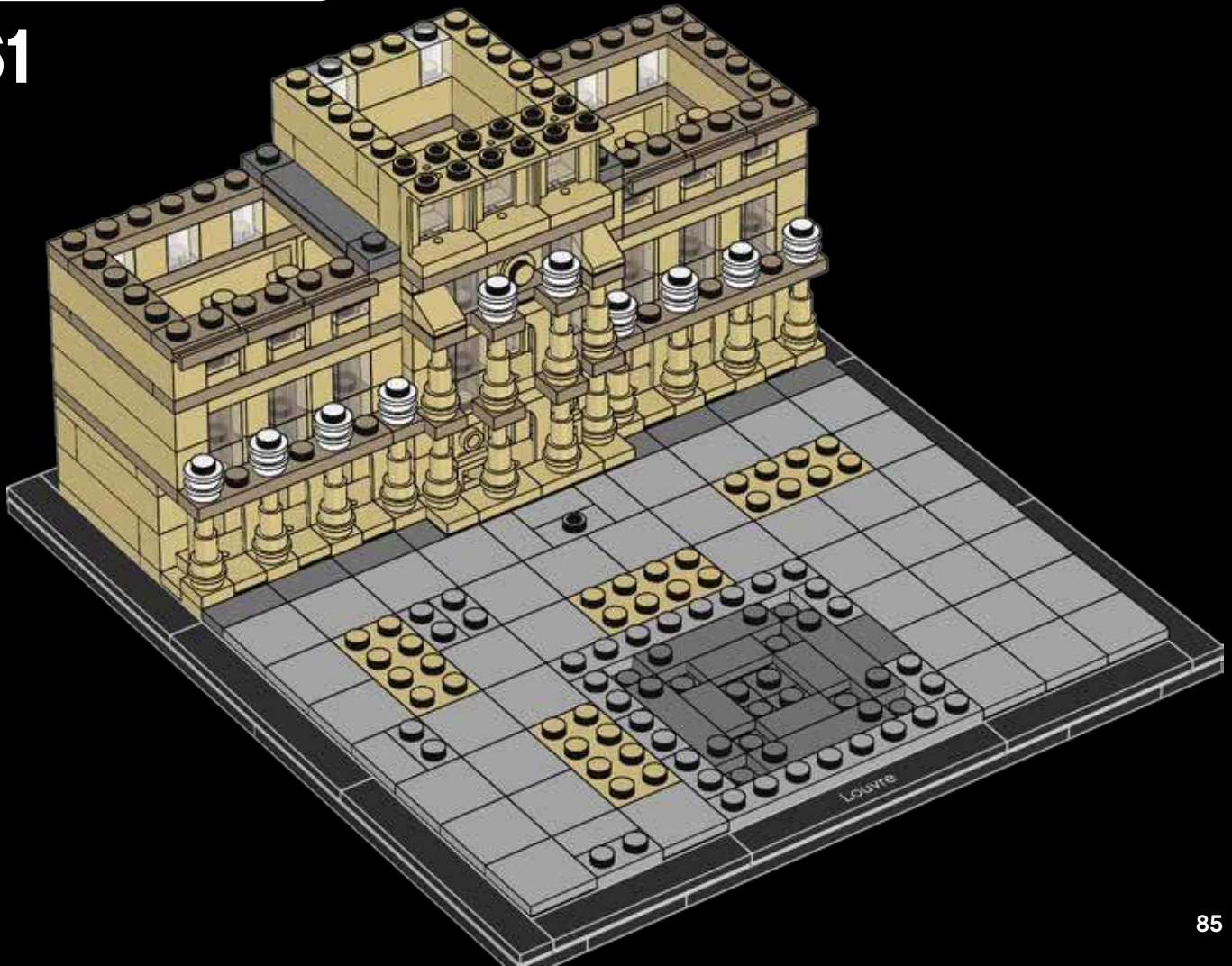

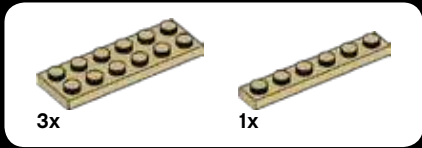

62

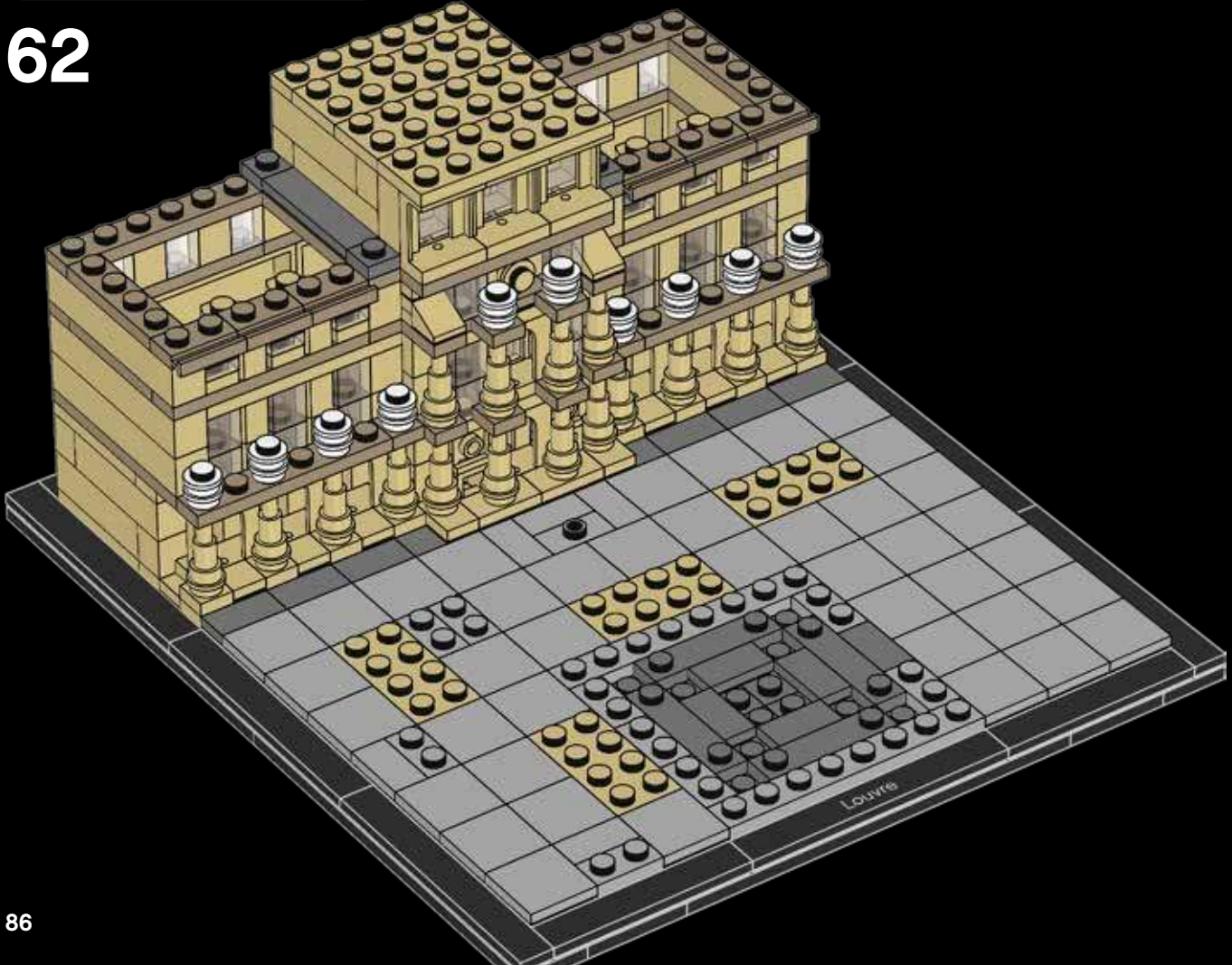



1

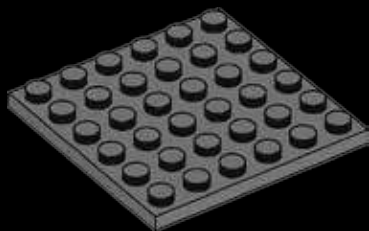

2

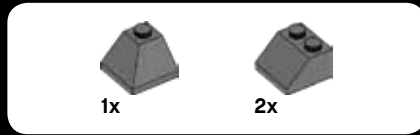
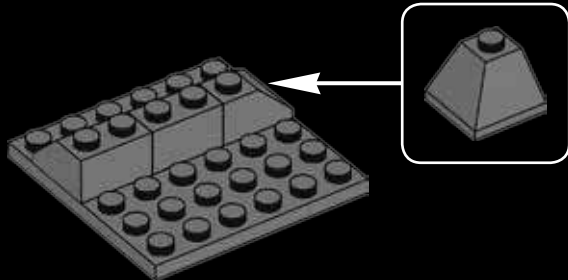

3

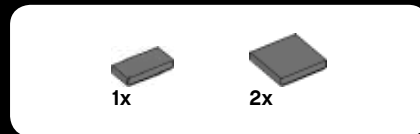
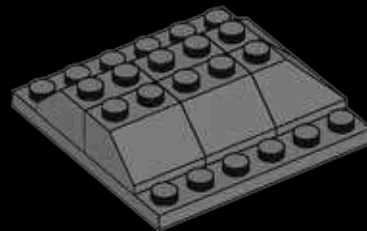

4

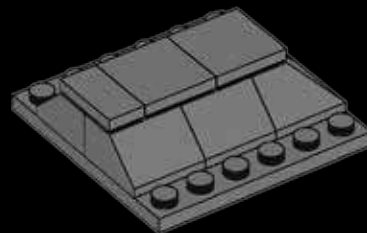

63

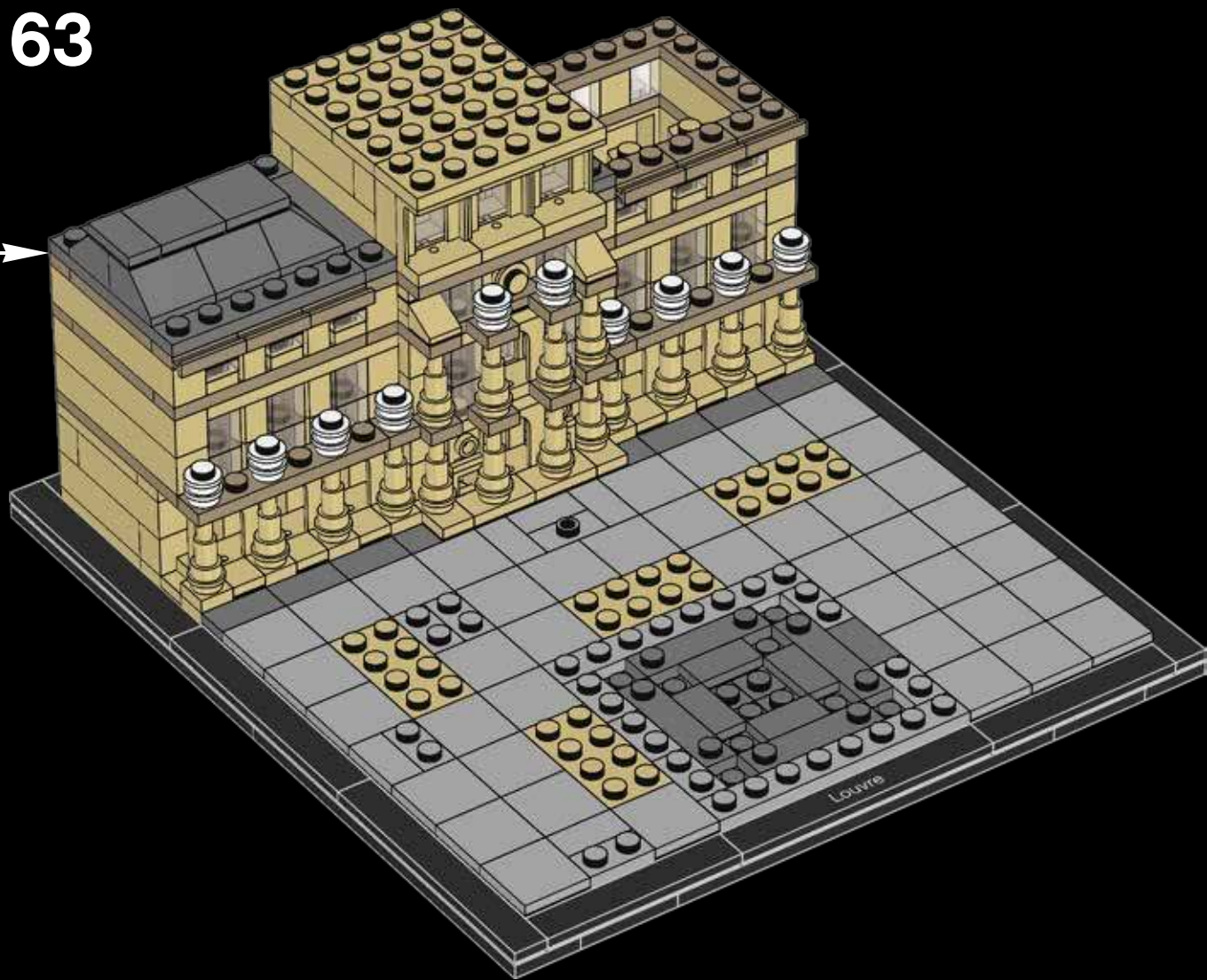



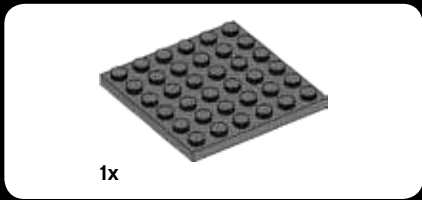

1

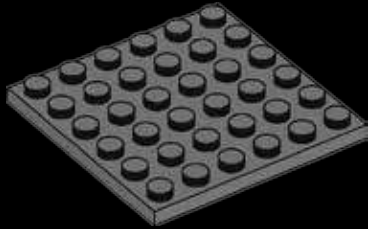

2

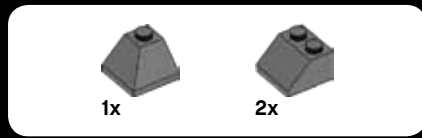
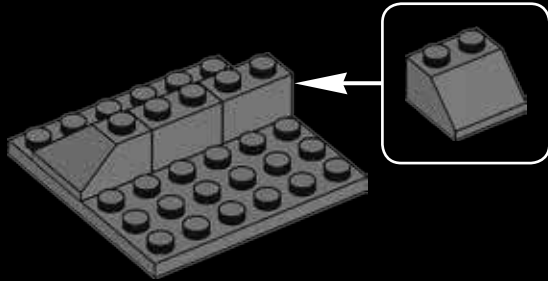

3

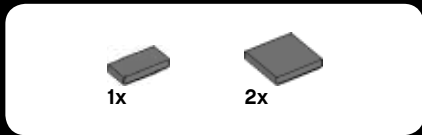
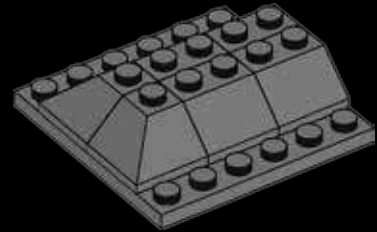

4

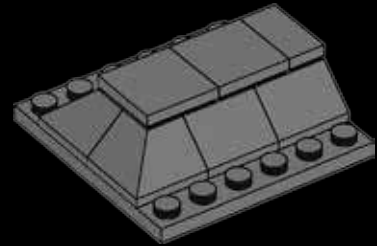

64

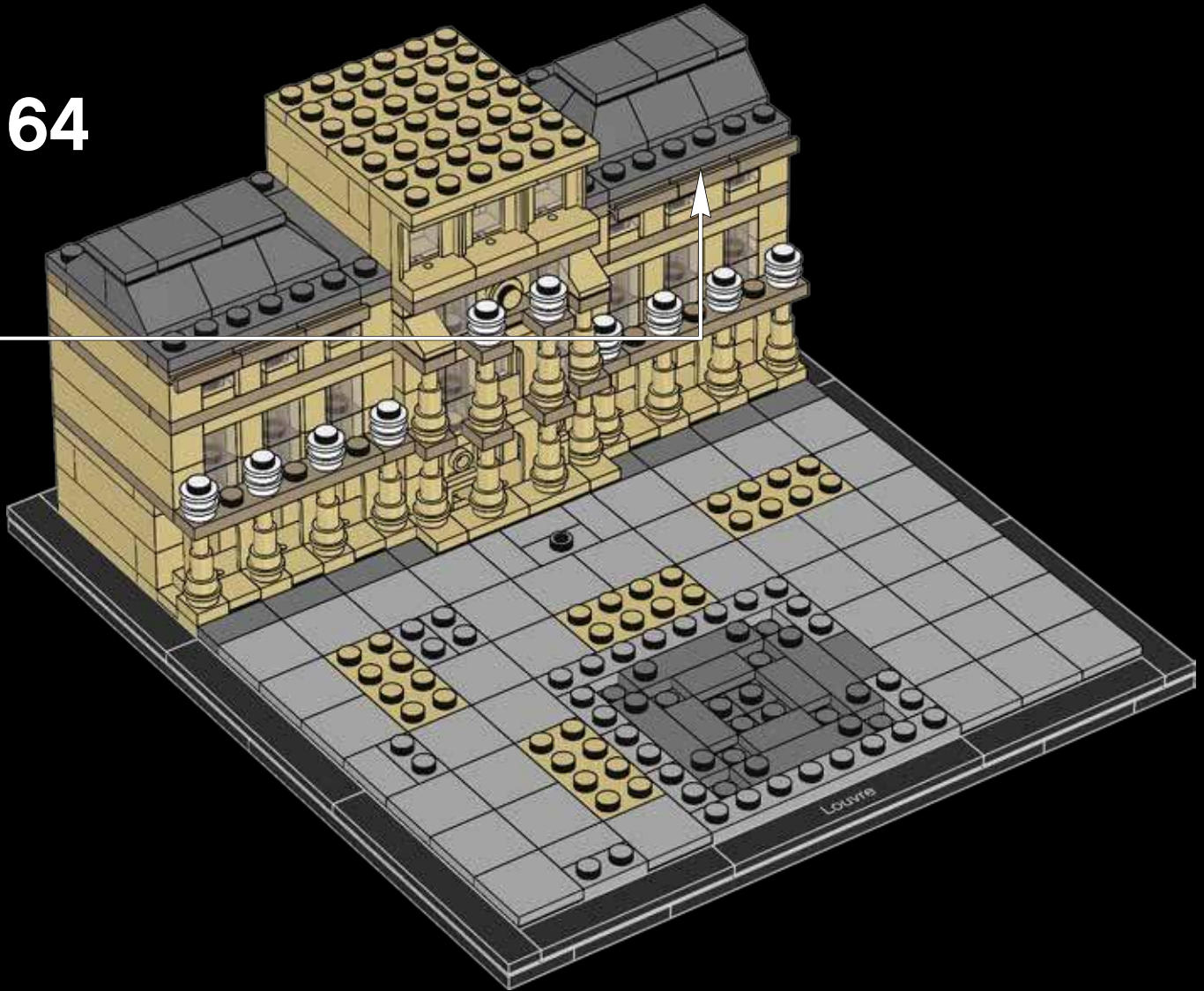



16x

65

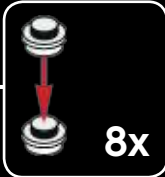
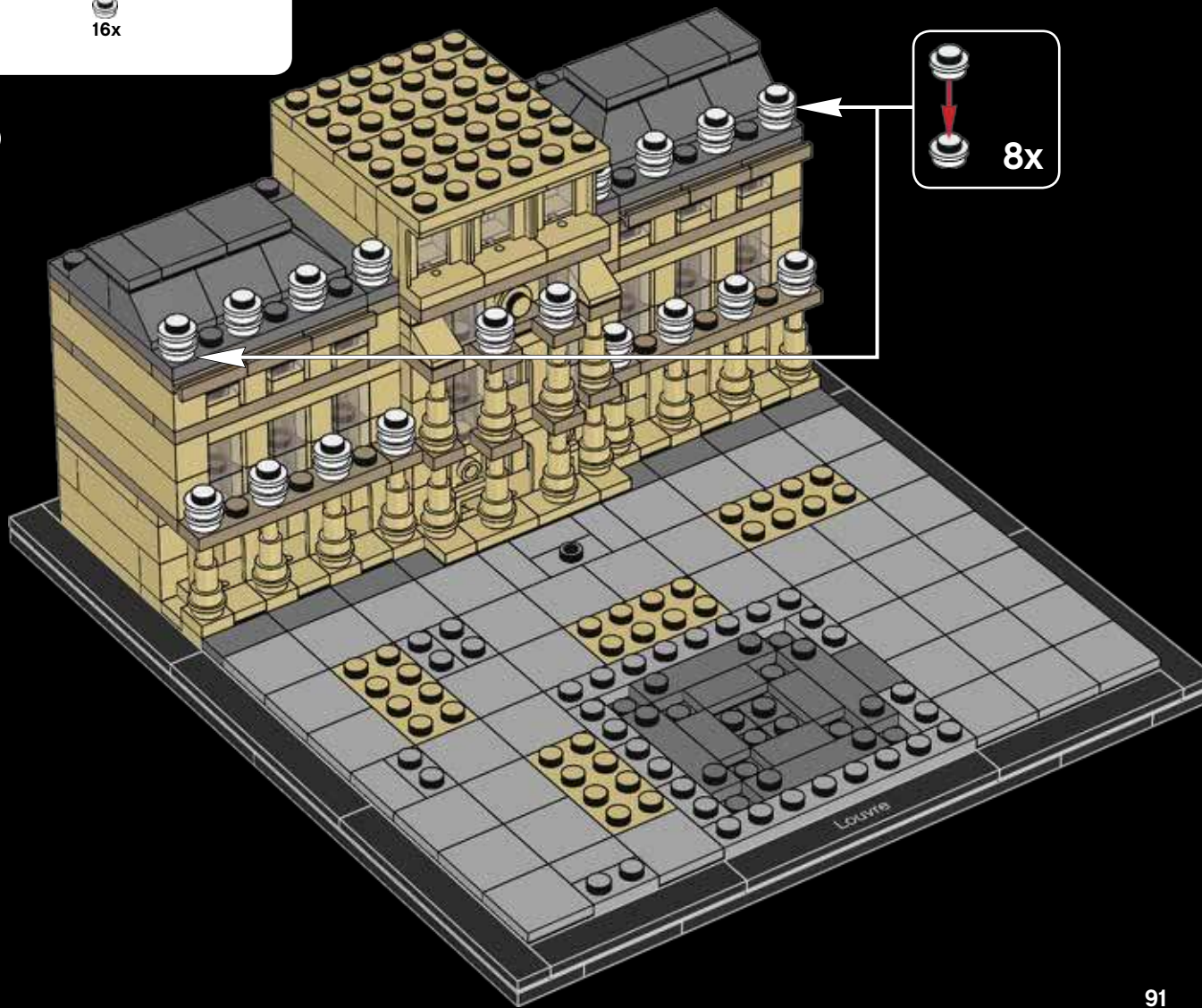

Louvre



1x

66

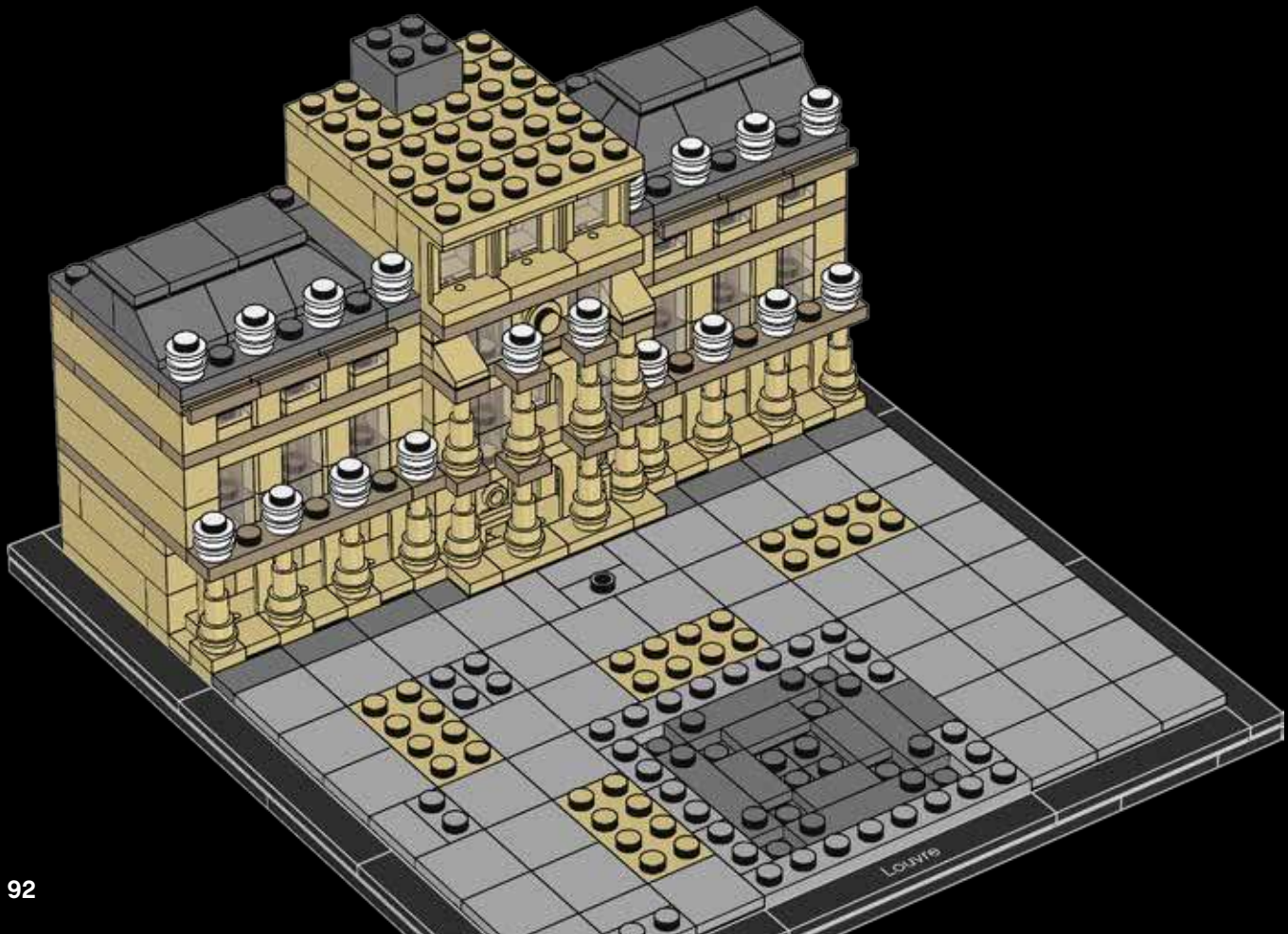

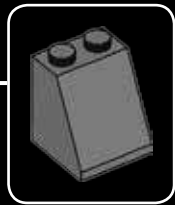
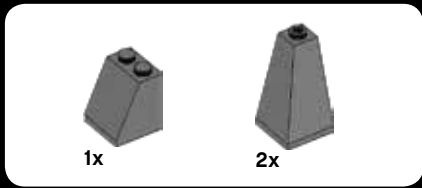

67

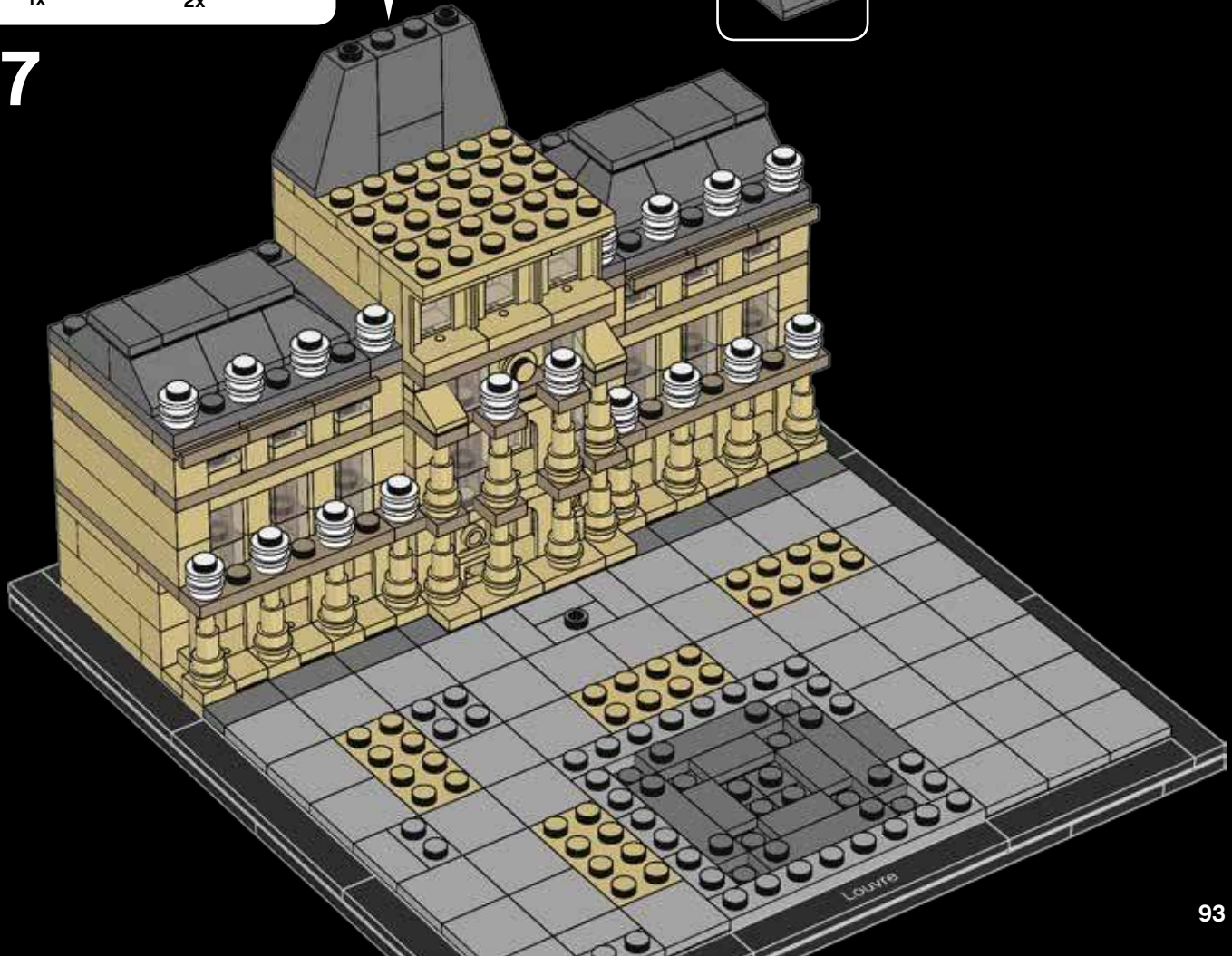



2x

68





4x

69



2x



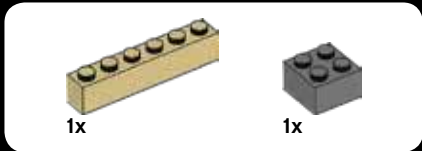

70

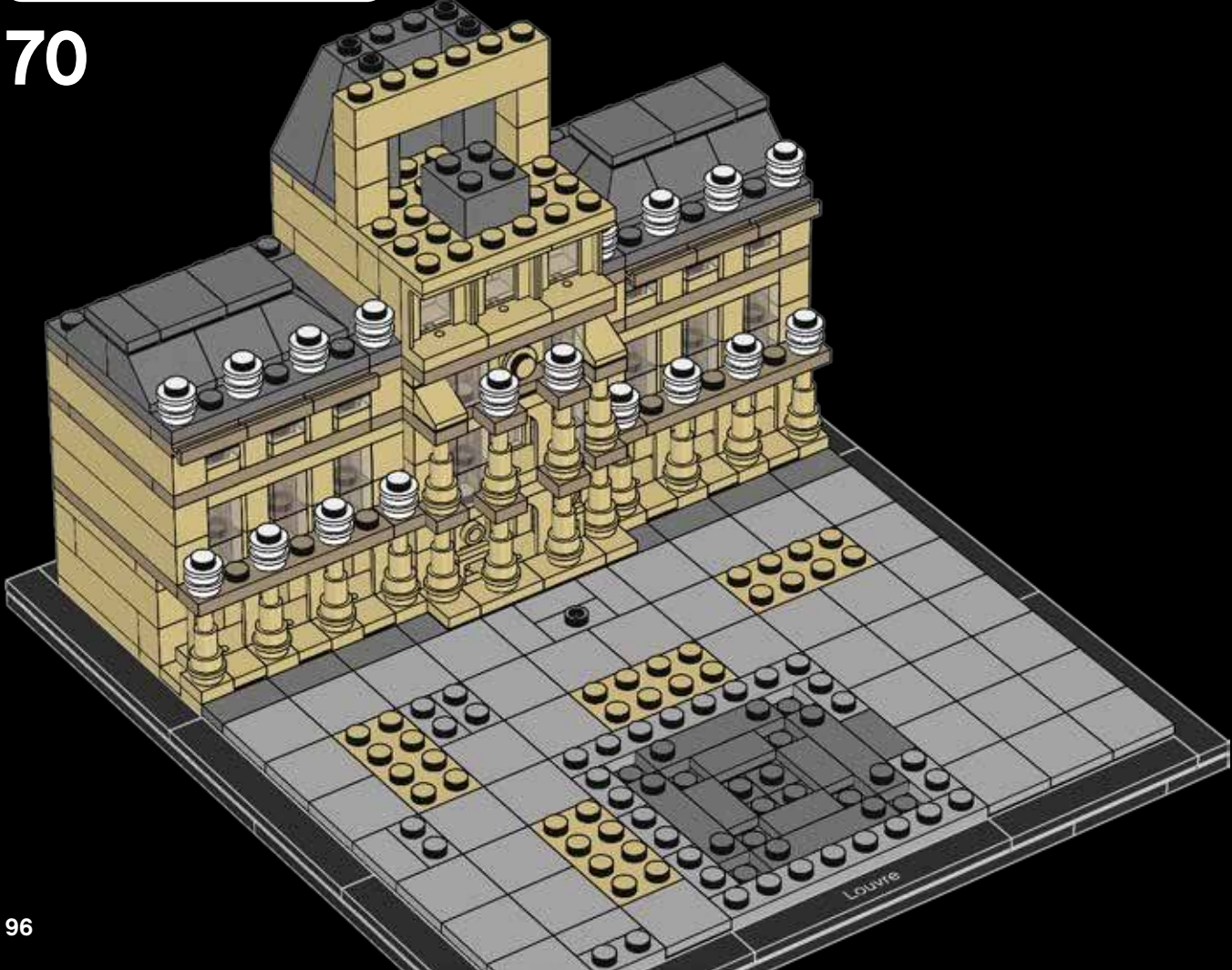





1x



2x

71

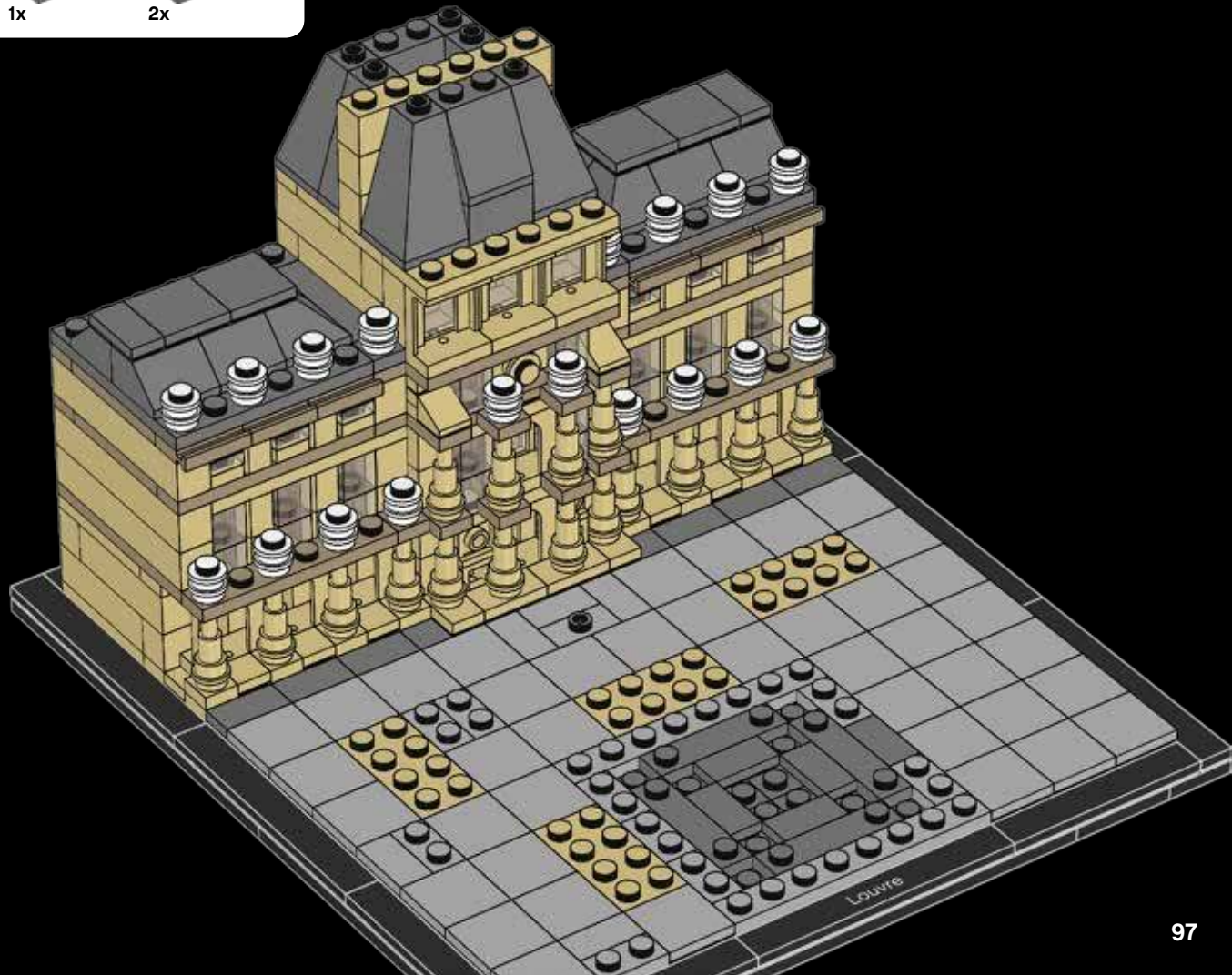



6x



2x

72





6x

73

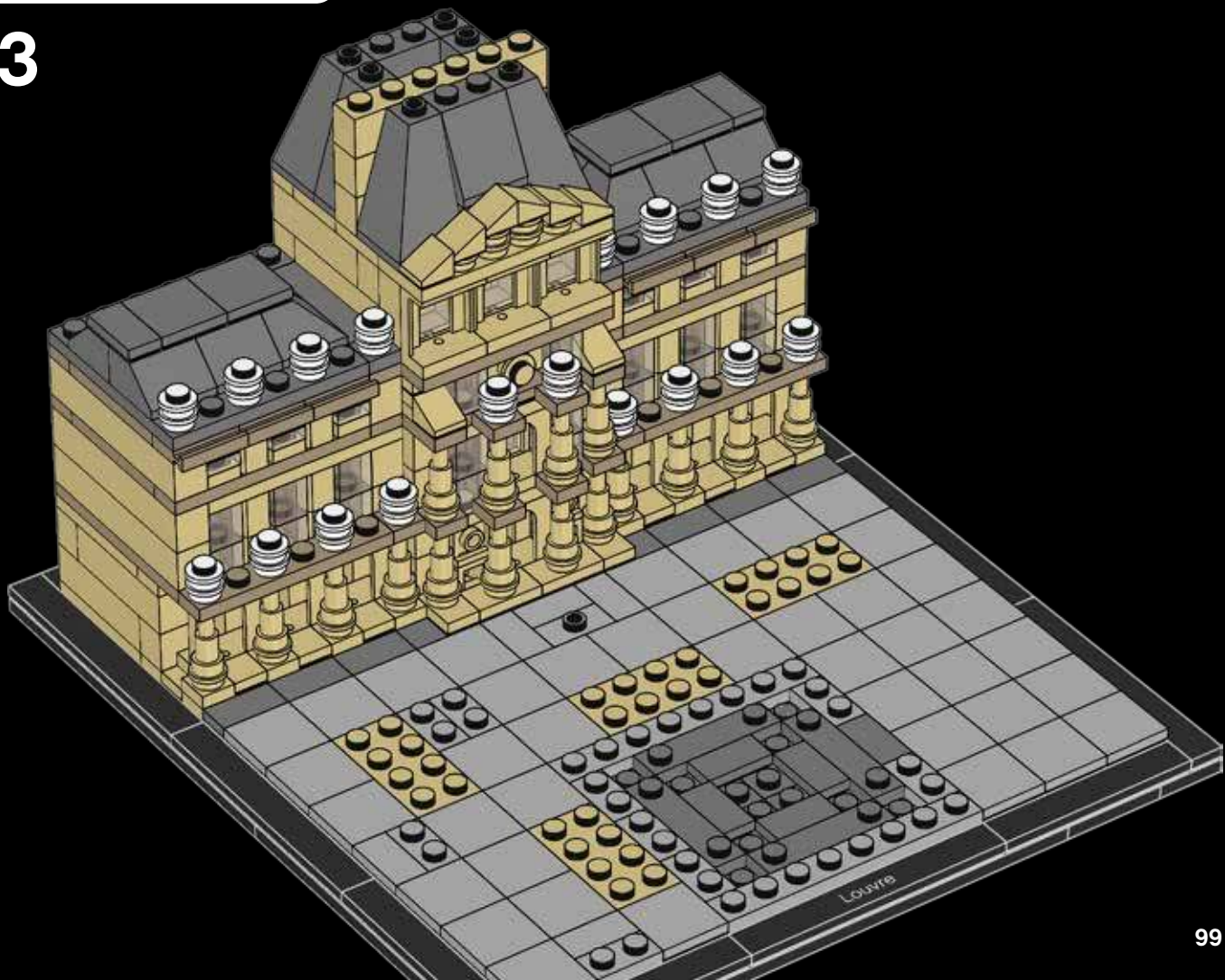



4x

74

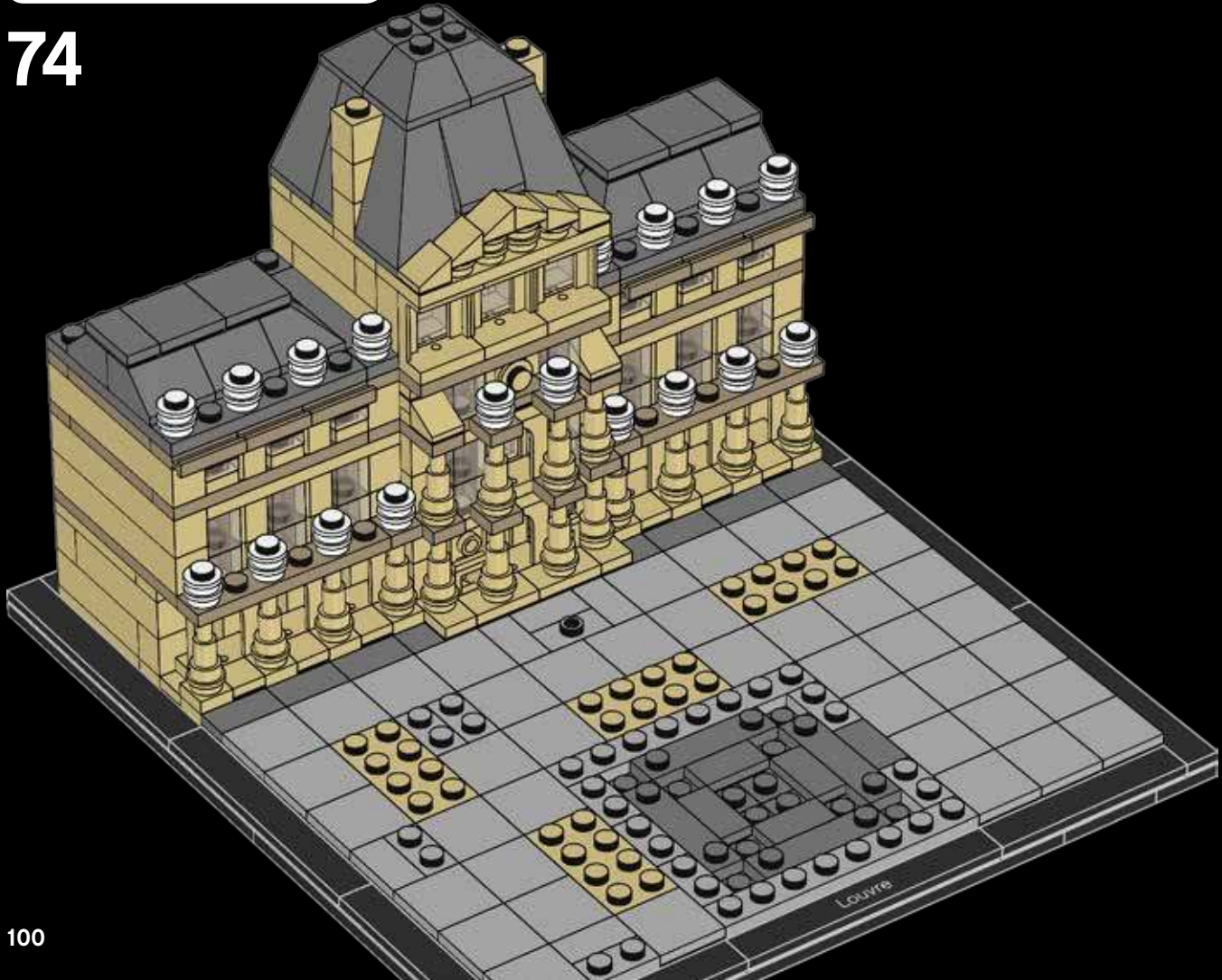



2x



2x



2x

# 75

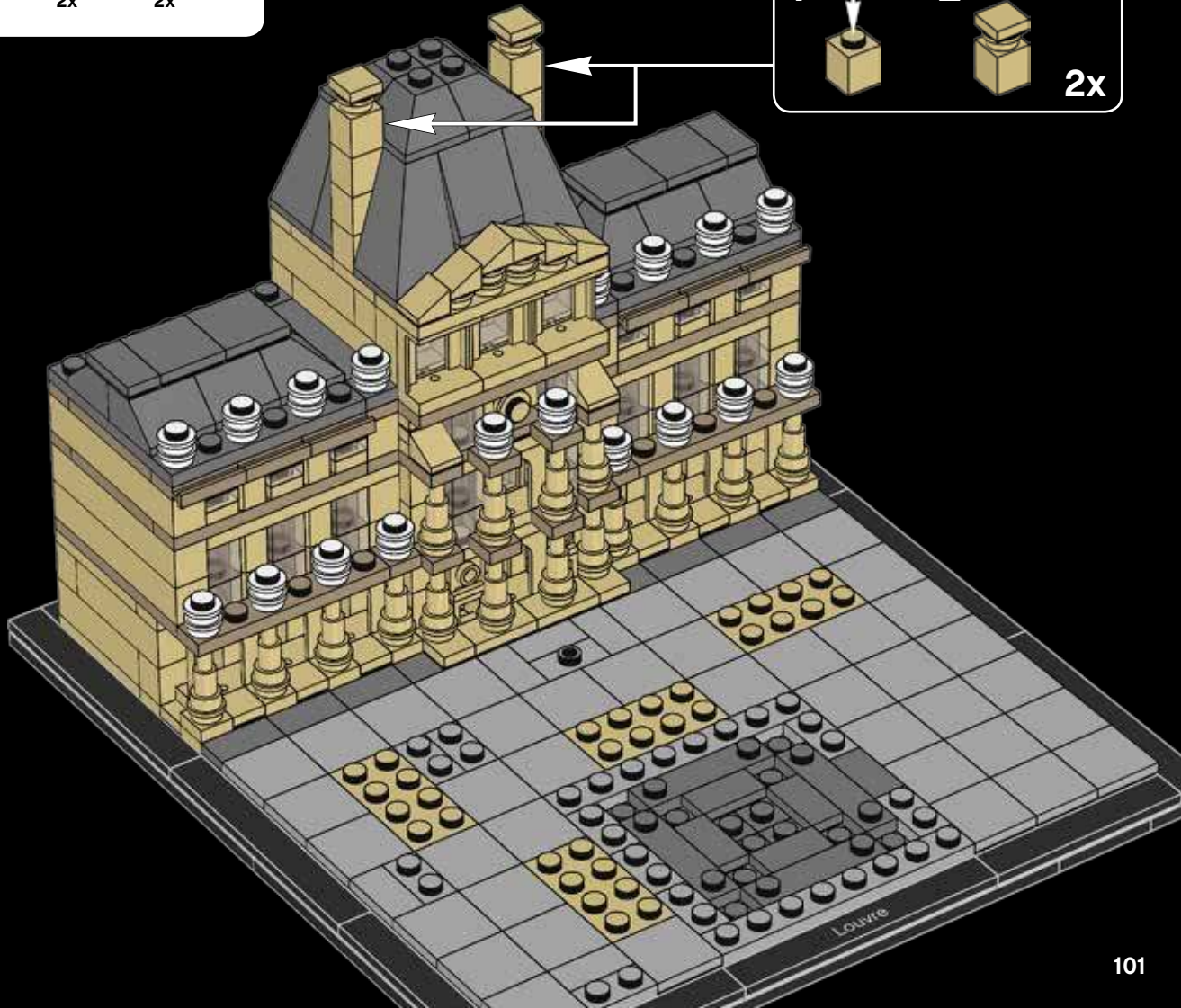
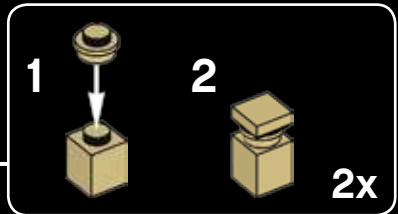



1x



1x

# 76

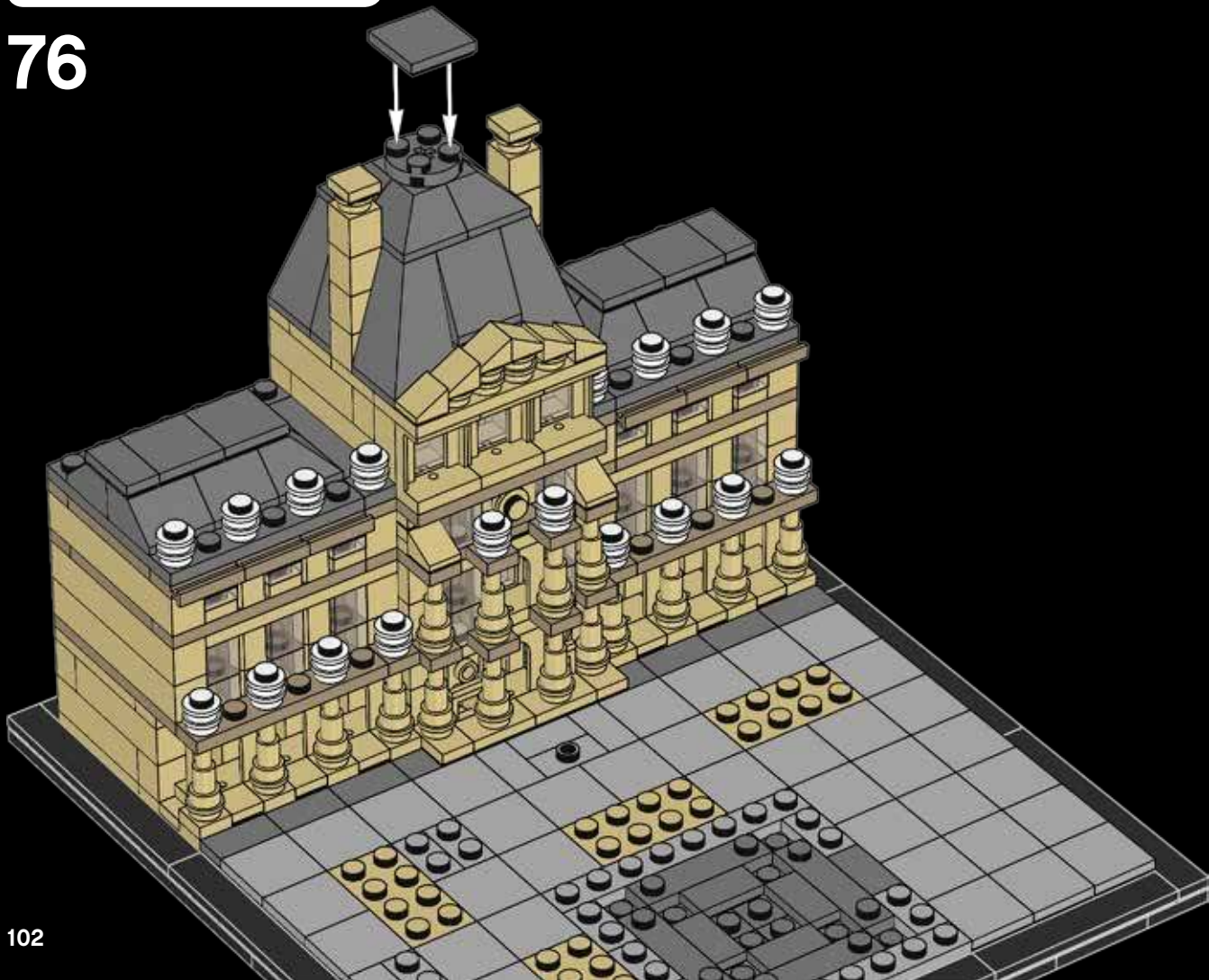



8x

77





9x

78







4x

79





4x

80

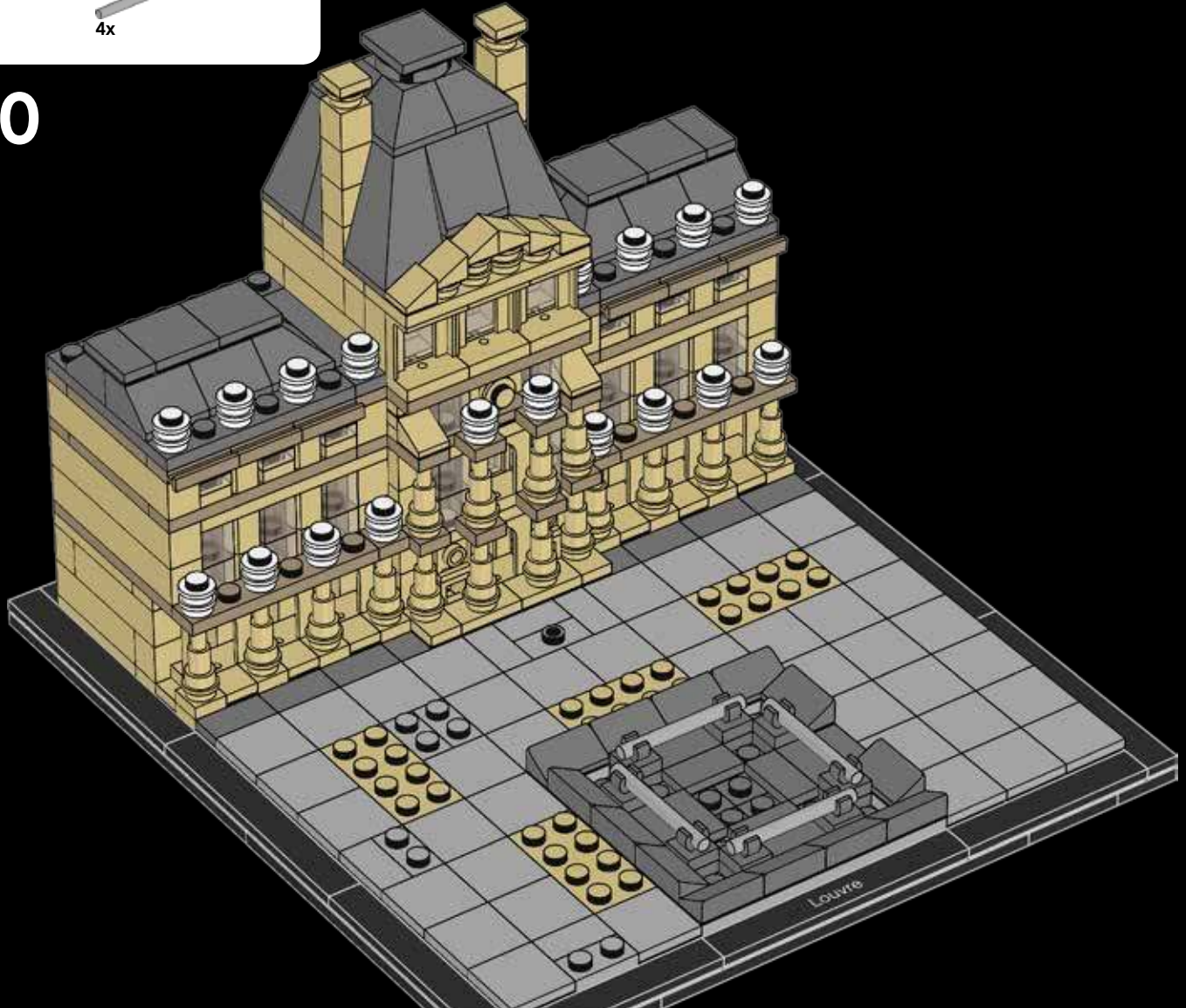



1x



4x



1x

# 81

1



2

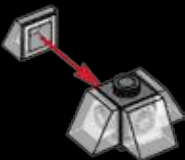

3

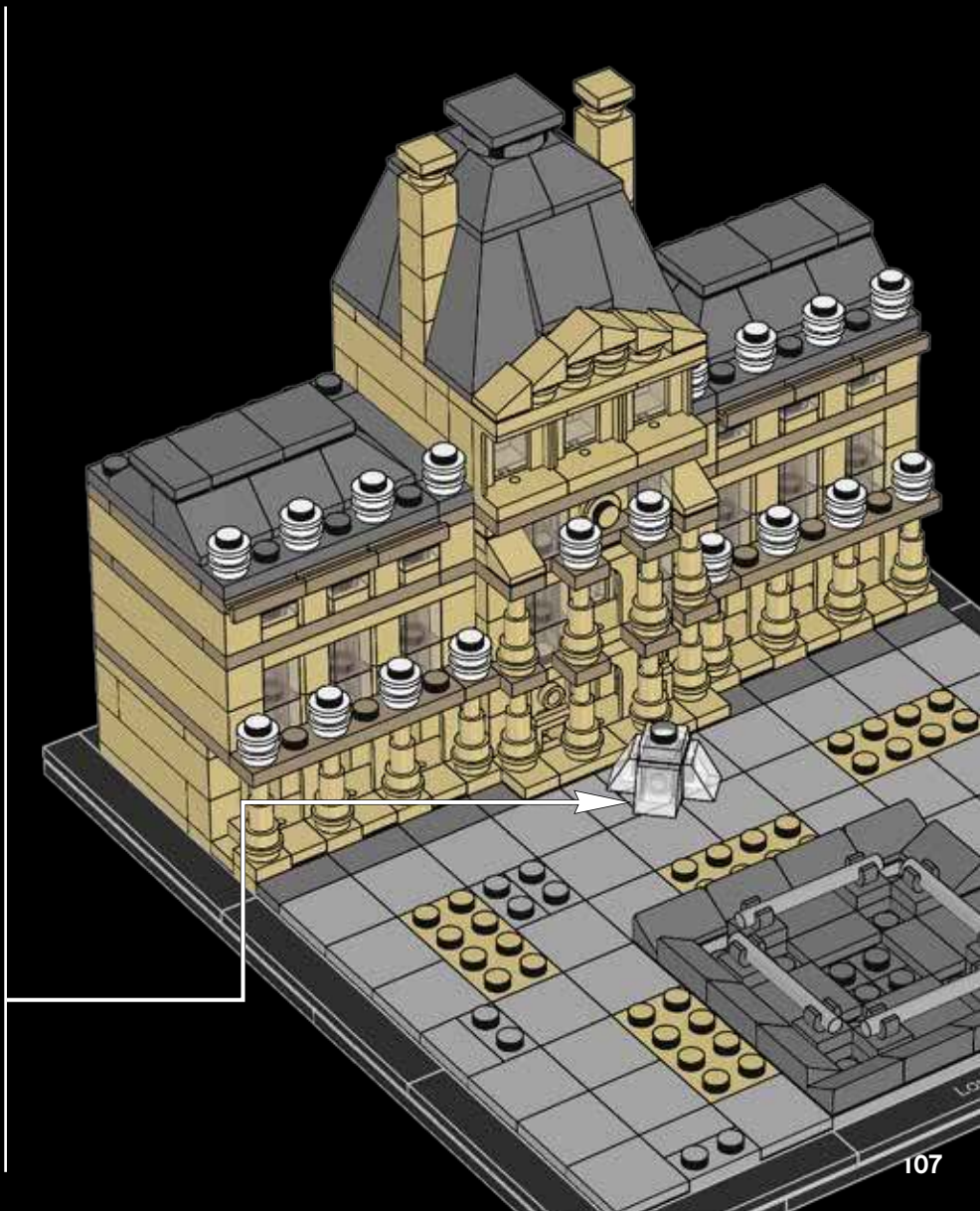



4x



1x

# 82

## 1



## 2





1x

83





6x

84

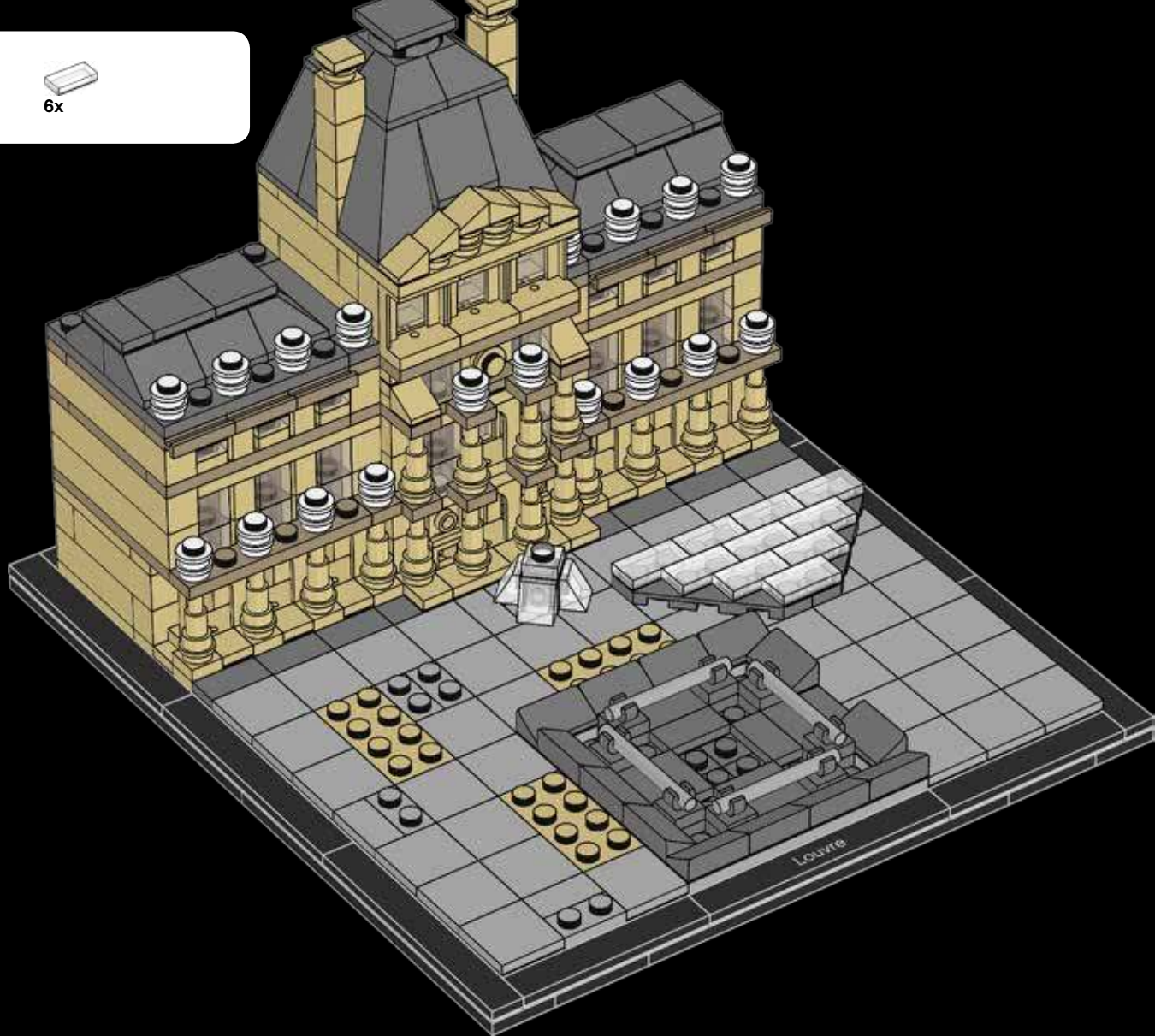



2x



4x



2x

# 85

# 1



# 2



# 2x

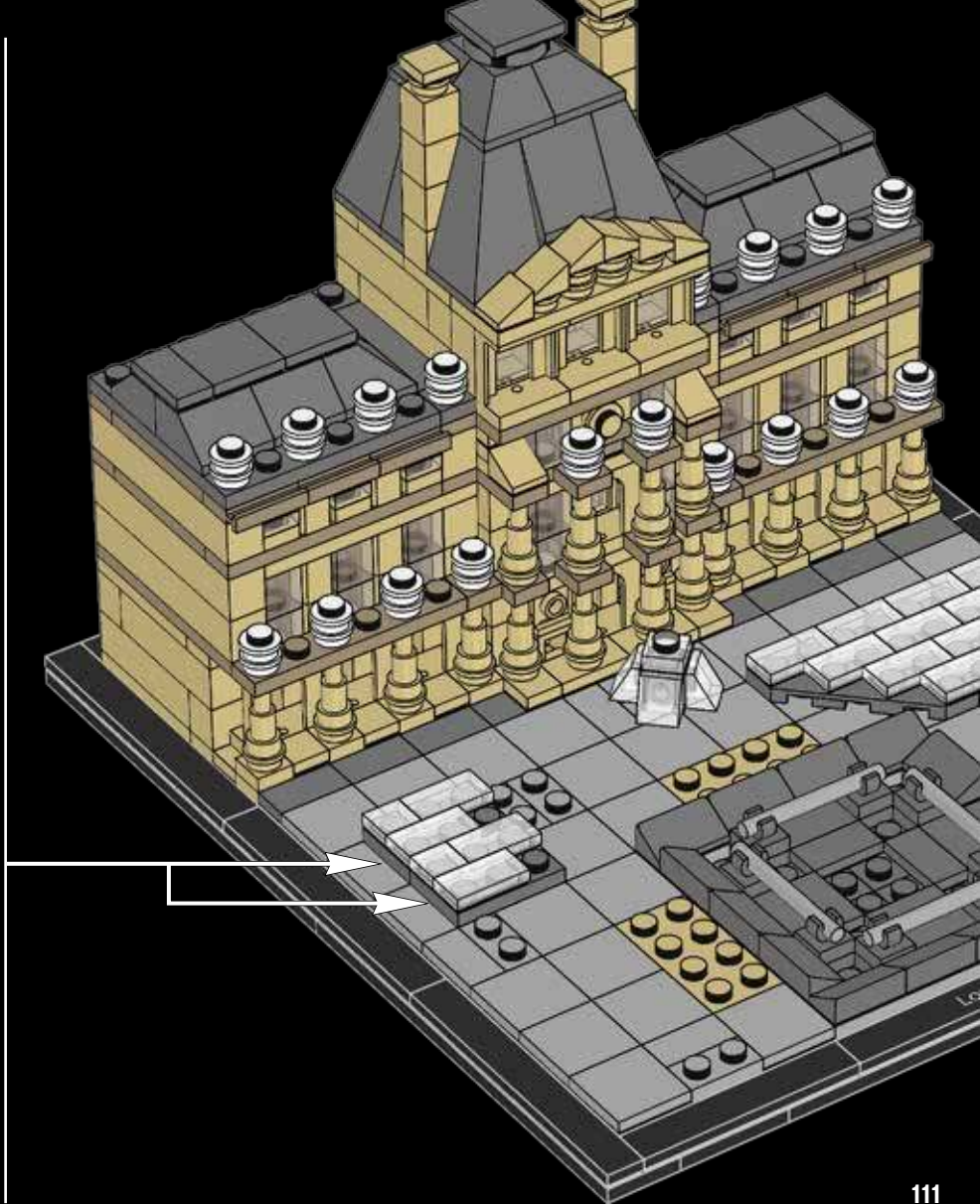



1x

86

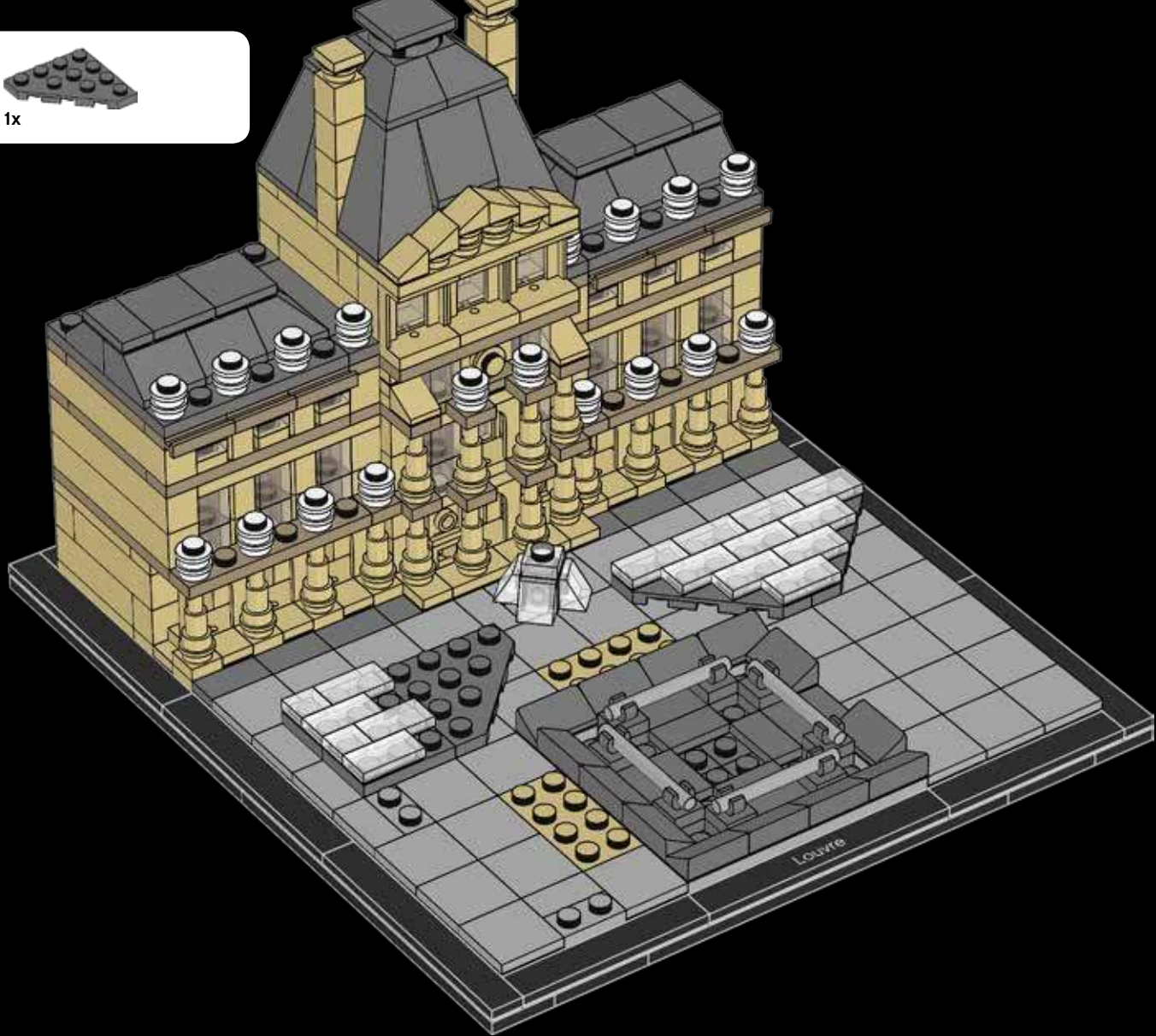





6x

87





2x



2x



1x

# 88

## 1



## 2

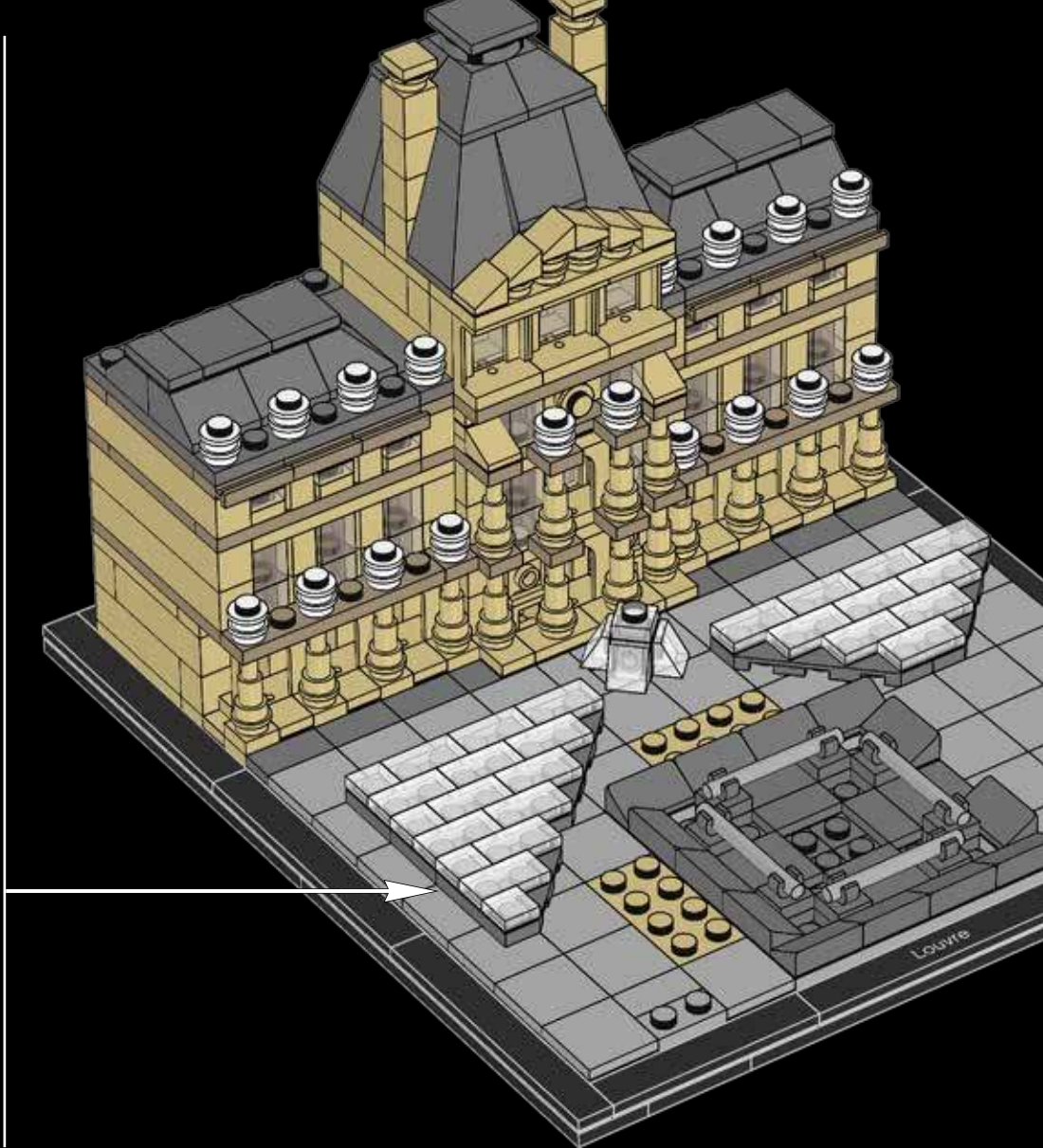



12x



2x

89

1



2



2x

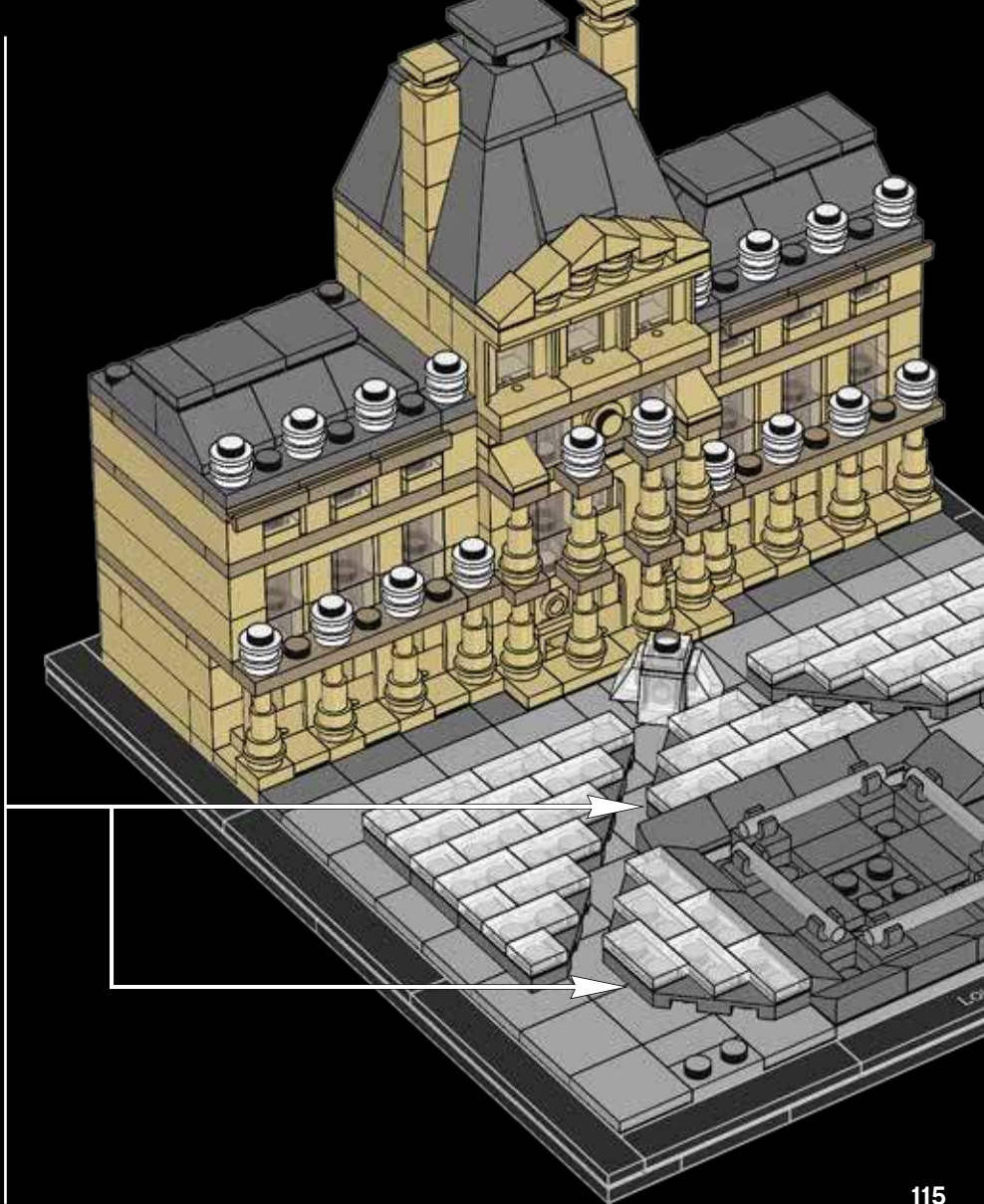



2x



2x



1x

# 90

## 1



## 2

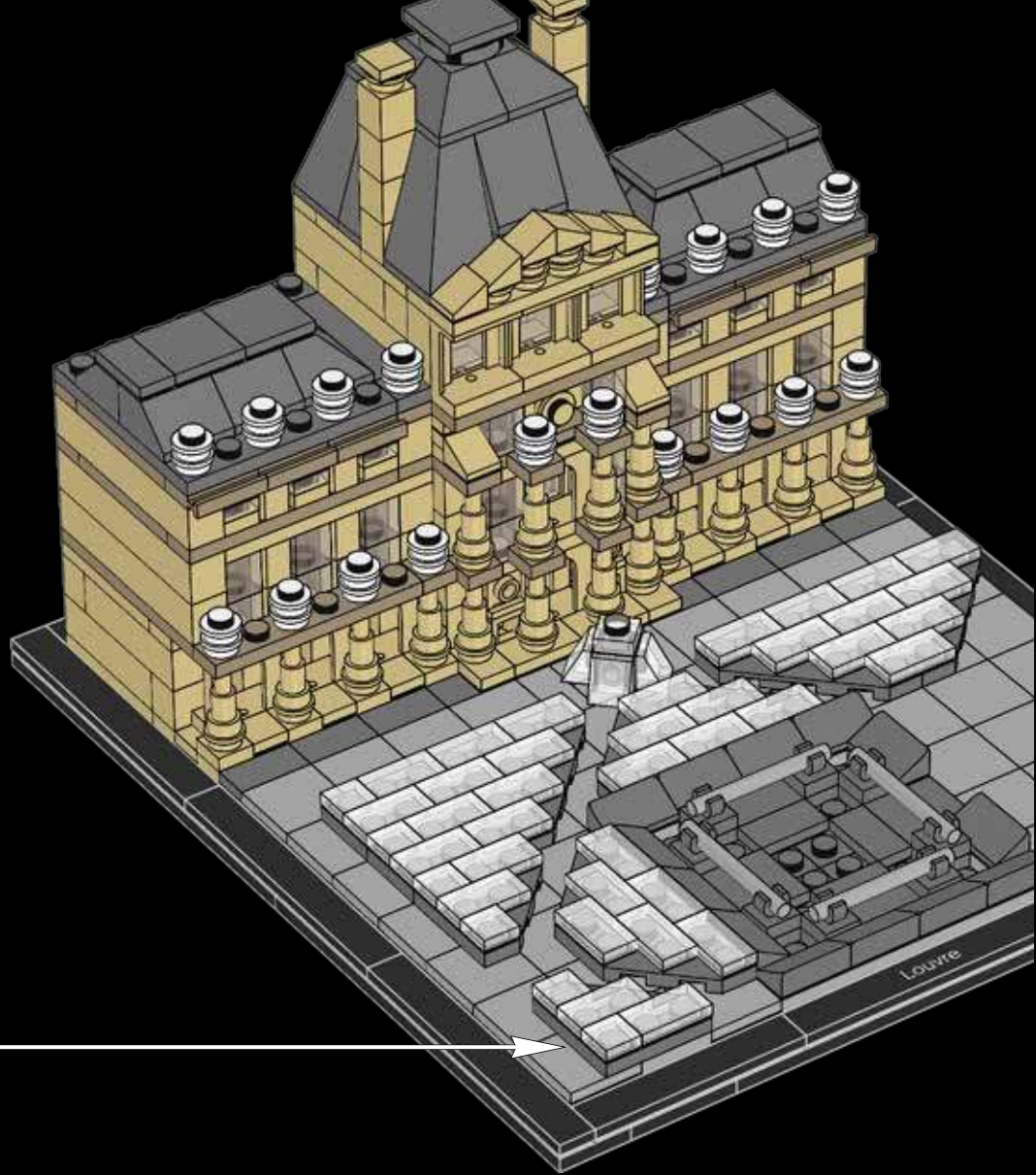



3x

91





2x



2x



2x



8x



8x

# 92

## 1



## 2



## 3



## 4

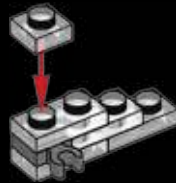

## 5

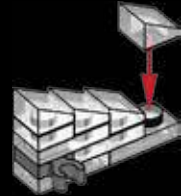

# 2x

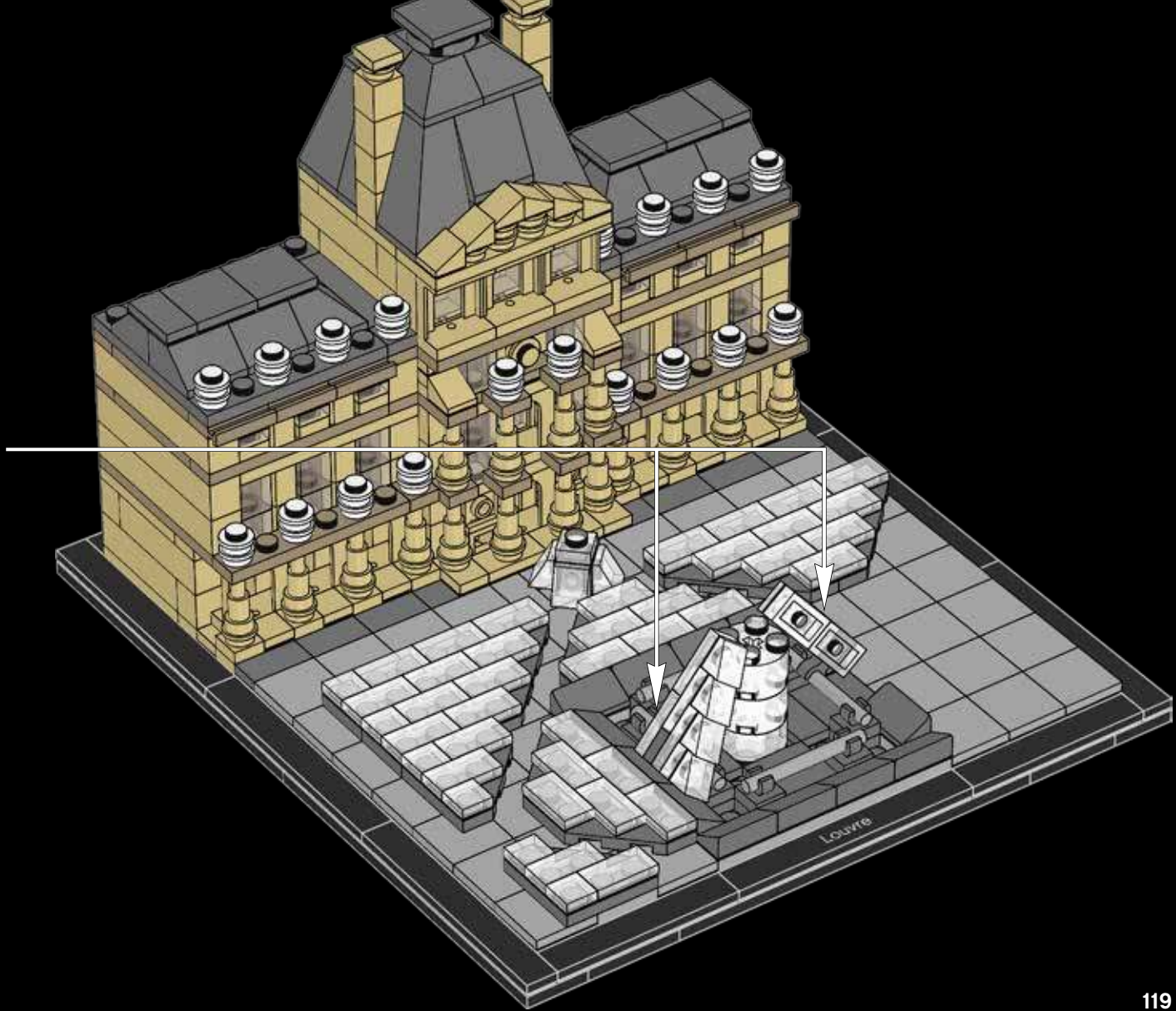

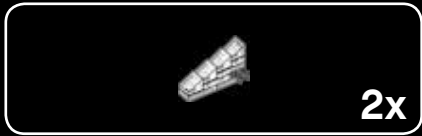

# 93

1



2



3

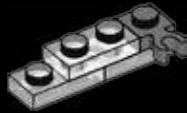

4

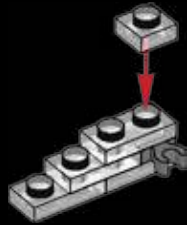

5

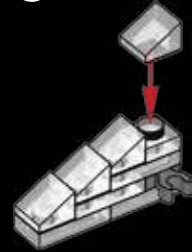

2x



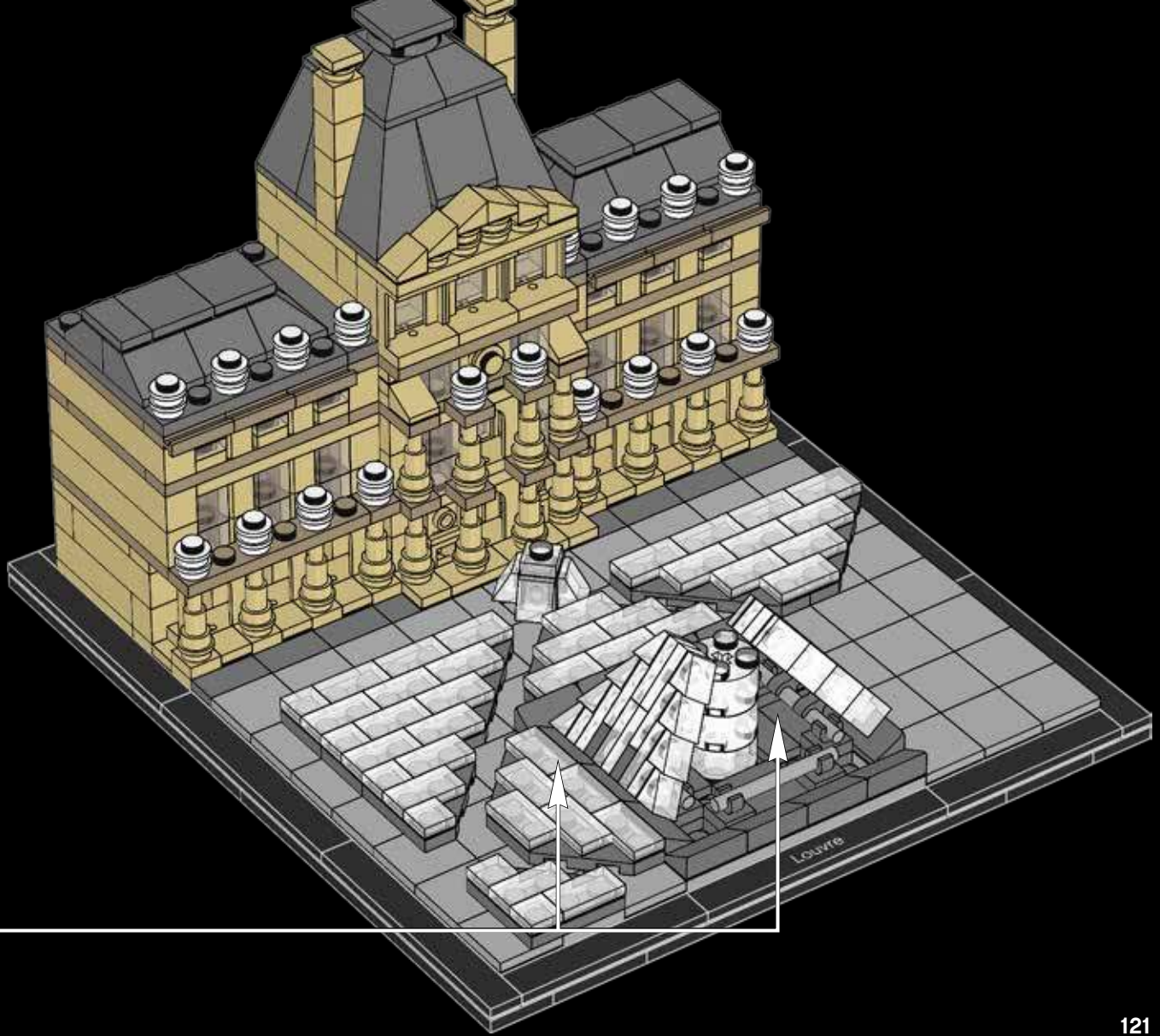



2x



1x



1x

1



1x

2



1x

3



1x



1x

4

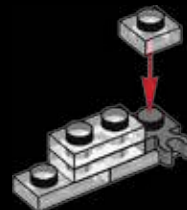



2x

5

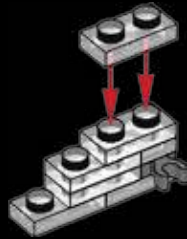

2x

6

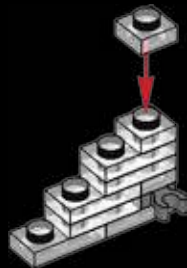

4x

7



2x

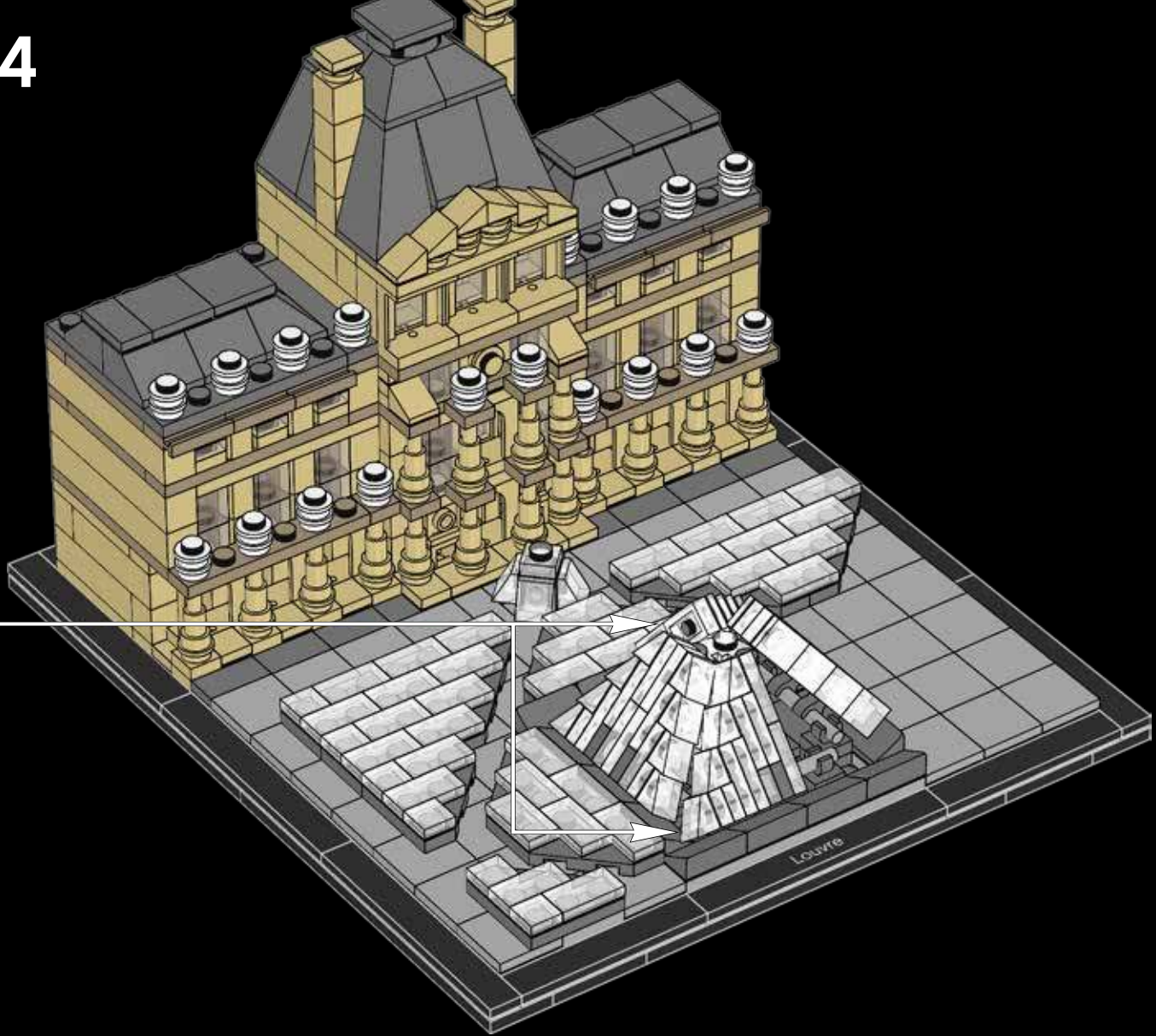



1



2



3

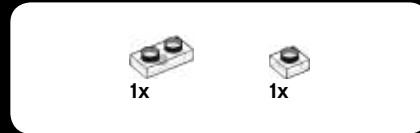

4

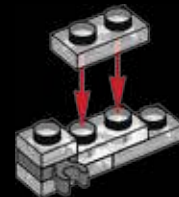



2x

5

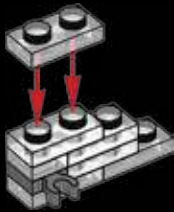

2x

6

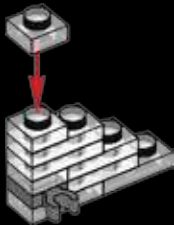

4x

7

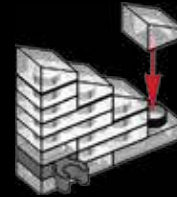

2x

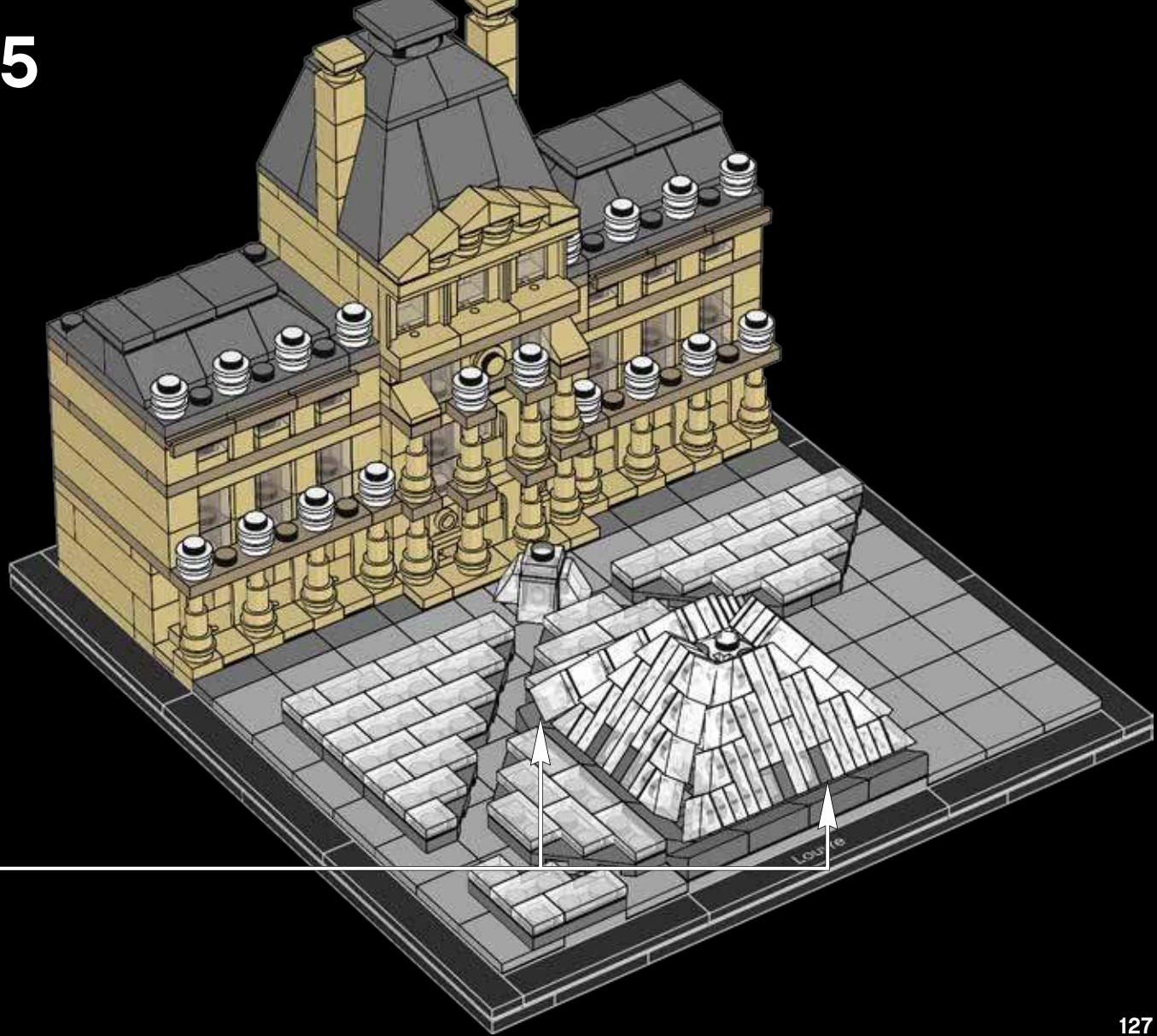



1x



4x



1x



1x

# 96

1



2



3

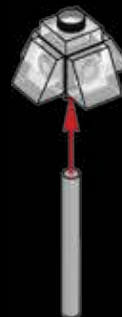



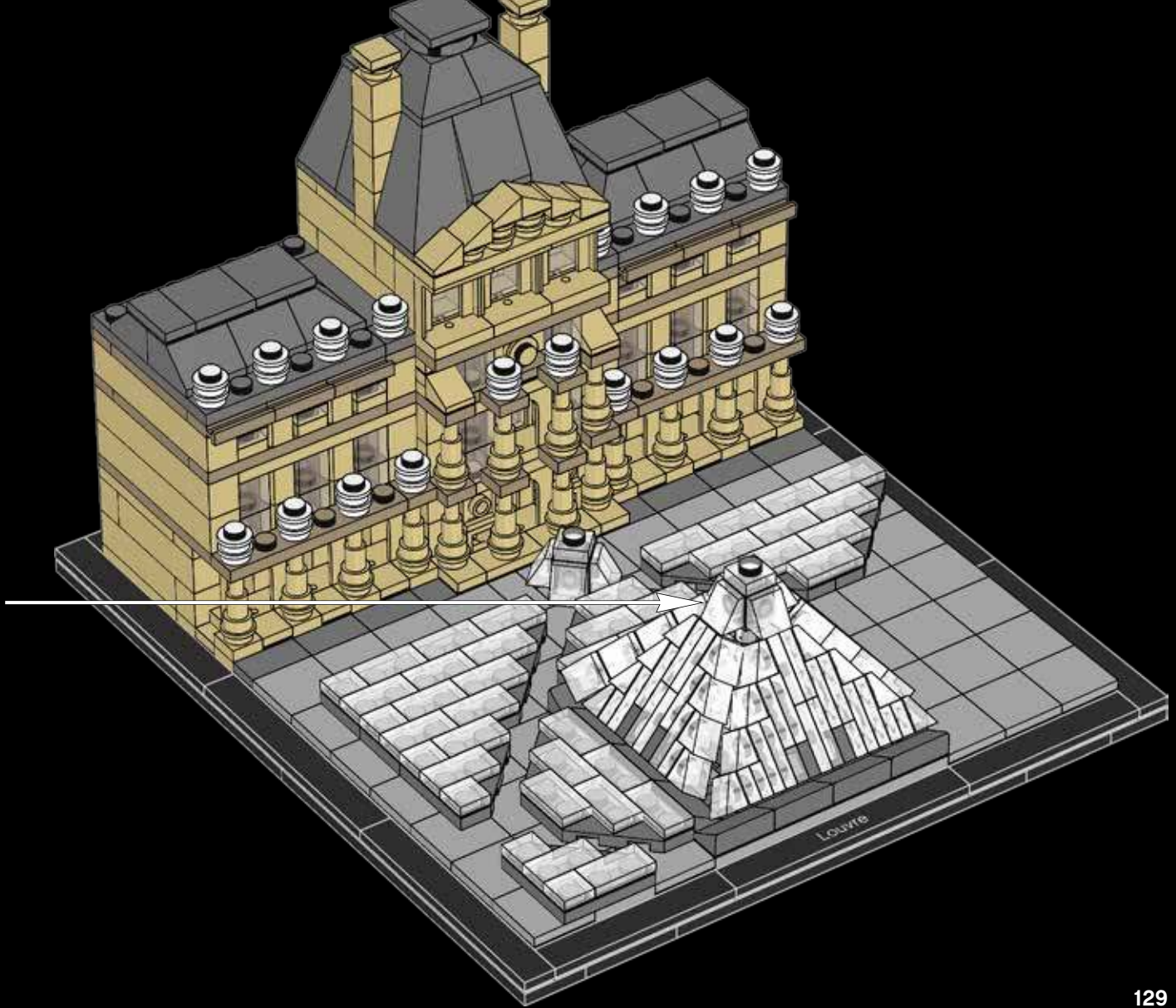

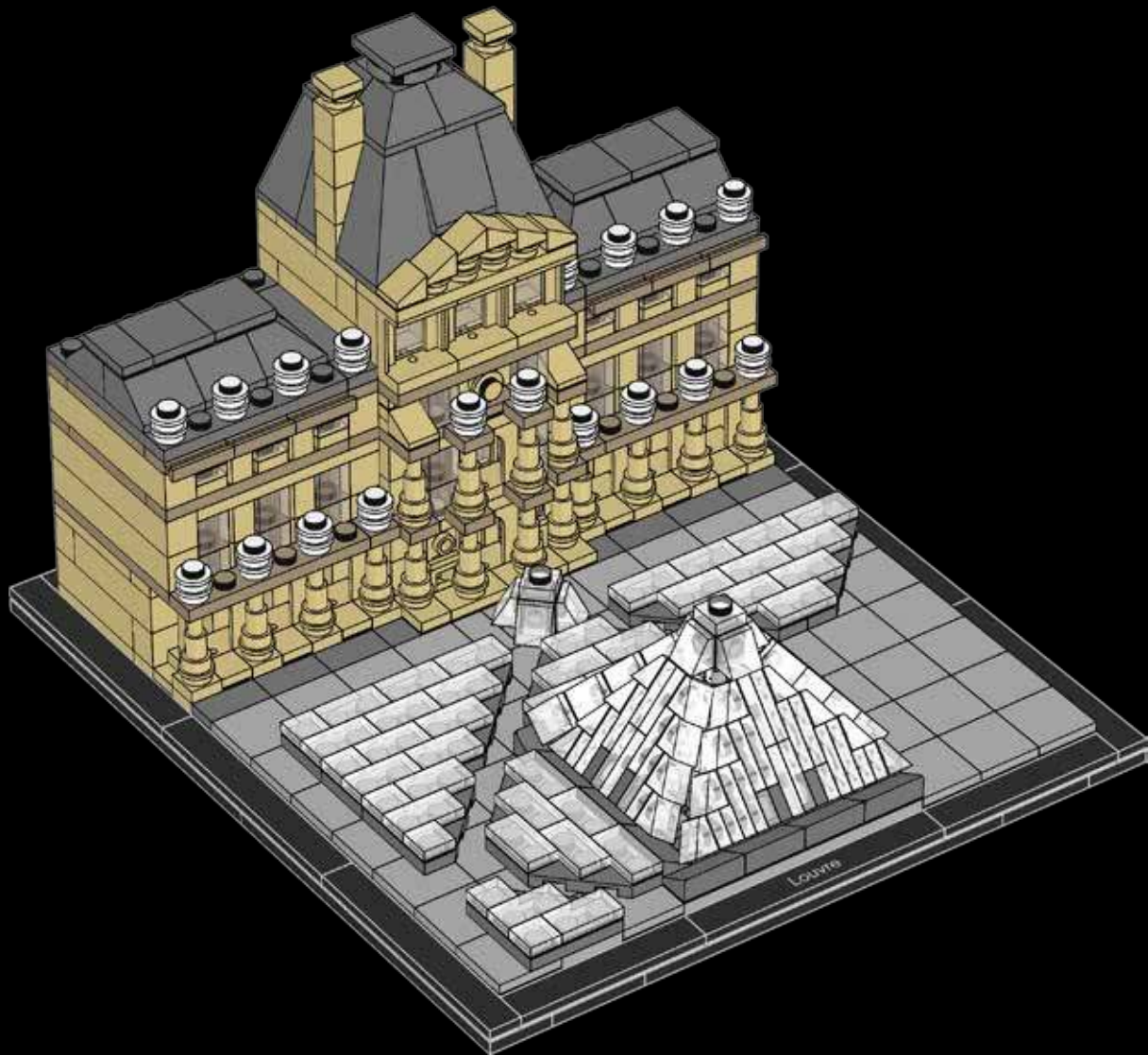



# LEGO® Architecture – then and now

There has always been a natural connection between the LEGO® brick and the world of architecture. Fans who build with LEGO elements instinctively develop an interest in the form and function of the structures they create. At the same time, many architects have discovered that LEGO bricks are the perfect way of physically expressing their creative ideas.

This connection was confirmed in the early 1960s with the launch of the LEGO 'Scale Model' line. It matched the spirit of the age where modern architects were redefining how houses look and people were taking an active interest in the design of their new homes. These sets were designed to be different from the normal, brightly coloured LEGO boxes; they also included a book on architecture as a source of inspiration.

Decades later, architect and LEGO fan Adam Reed Tucker, revived the idea of expressing architecture using LEGO bricks and in partnership with the LEGO Group, launched the LEGO Architecture line that we know today. His first models, and the original sets in the current LEGO Architecture series, were interpretations of famous skyscrapers from his hometown of Chicago. Since then LEGO Architecture has developed and evolved, first with well-known buildings from other

cities in the United States, and now with iconic structures from Europe, the Middle East and Asia.

The introduction of our LEGO Architecture Studio set echoes the ambitions of the earlier LEGO 'Scale Model' line and widens the potential of the LEGO Architecture series. Now you can enjoy building and learning about specific landmark buildings, or create exciting architectural models from your own fantasy. An inspiring 270-page book, featuring a number of renowned architects from around the world, guides you through the principles of architecture and encourages you in your own creative building.



21050  
LEGO Architecture Studio

# LEGO® Architecture – Hier et aujourd'hui

Il y a toujours eu une connexion naturelle entre la brique LEGO® et le monde de l'architecture. Les fans qui construisent avec des éléments LEGO développent instinctivement un intérêt pour la forme et la fonction des structures qu'ils créent. De nombreux architectes ont quant à eux découvert que les briques LEGO sont la façon idéale de matérialiser leurs idées de création.

Cette connexion a été confirmée au début des années 1960 avec le lancement de la gamme « Maquettes à l'échelle » LEGO. Cette gamme correspondait à l'esprit de l'époque, alors que les architectes modernes redéfinissaient les maisons, et que les gens s'intéressaient activement à la conception de leur résidence. Ces ensembles originaux étaient conçus pour être différents des boîtes LEGO habituelles aux couleurs vives, et incluaient aussi un livret d'architecture comme source d'inspiration.

Quelques décennies plus tard, l'architecte et fan de LEGO Adam Reed Tucker a fait revivre l'idée d'exprimer l'architecture en utilisant des briques LEGO. En partenariat avec le Groupe LEGO, il lança la gamme LEGO Architecture que nous connaissons aujourd'hui. Ses premiers modèles, et les ensembles originaux de la gamme LEGO Architecture actuelle, étaient

des interprétations de célèbres gratte-ciel de sa ville natale de Chicago. La gamme LEGO Architecture a depuis évolué et s'est élargie, tout d'abord avec des bâtiments célèbres d'autres villes des États-Unis, puis avec de célèbres monuments d'Europe, du Moyen-Orient et d'Asie.

L'introduction de notre ensemble LEGO Architecture Studio fait écho aux ambitions de la précédente gamme « Maquettes à l'échelle » LEGO et accroît le potentiel de la gamme LEGO Architecture. Vous pouvez maintenant découvrir et construire des monuments célèbres ou créer de passionnants modèles architecturaux nés de votre imagination. Un livret d'inspiration de 270 pages, présentant plusieurs architectes célèbres du monde entier, vous guide parmi les principes de l'architecture et vous encourage dans votre propre construction créatrice.



21050  
LEGO Architecture Studio

Celebrate the world of architecture and collect all the models  
Célébrez le monde de l'architecture et collectionnez tous les modèles

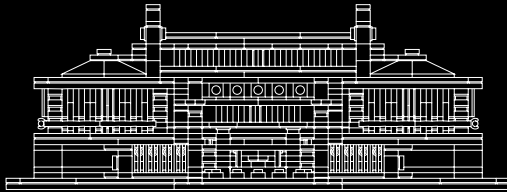

21017  
Imperial Hotel  
Hôtel Imperial

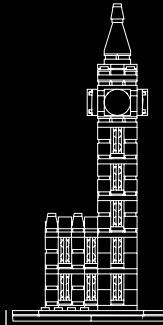

21013  
Big Ben

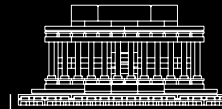

21022  
Lincoln Memorial  
Le monument de Lincoln

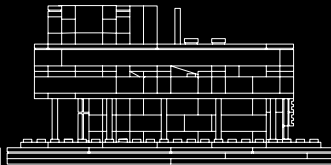

21014  
Villa Savoye

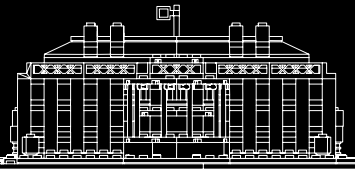

21006  
The White House  
La Maison-Blanche

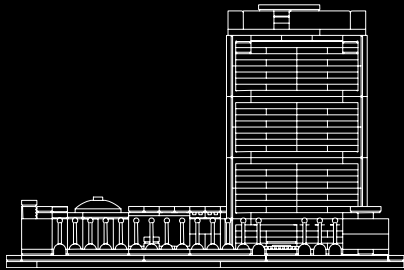

21018  
United Nations Headquarters  
Le siège des Nations Unies



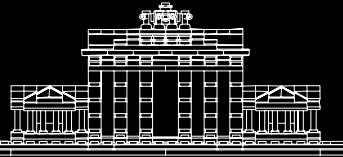

21011  
Brandenburg Gate  
La porte de Brandebourg



21020  
Trevi Fountain  
La fontaine de Trevi

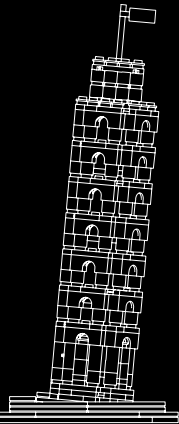

21015  
The Leaning Tower of Pisa  
La tour penchée de Pise

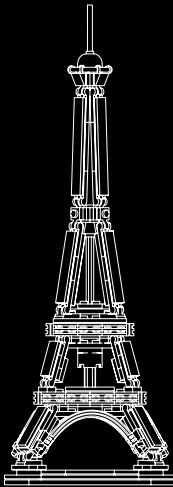

21019  
The Eiffel Tower  
La tour Eiffel



21003  
Seattle Space Needle  
Space Needle de Seattle

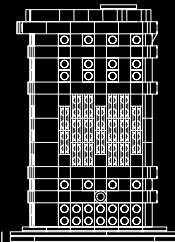

21023  
Flatiron Building  
Le Flatiron Building

# References

*Text credits:*

[www.louvre.fr](http://www.louvre.fr)

*Photography:*

[www.photo.rmn.fr](http://www.photo.rmn.fr)

# Références

*Texte :*

[www.louvre.fr](http://www.louvre.fr)

*Photographie :*

[www.photo.rmn.fr](http://www.photo.rmn.fr)

Customer Service  
Kundenservice  
Service Consommateurs  
Servicio Al Consumidor  
LEGO.com/service or dial



00800 5346 5555 :     

1-800-422-5346 : 