



# INSTALLATION, MAINTENANCE AND USE INSTRUCTIONS FOR FREE-STANDING COOKERS 90x60 cm GIANT OVEN

Model TS95C61LVI	Order No.: 331-10555
Model TS95C61LNE	Order No.: 331-1155
Model TS95C61LX	Order No.: 331-1160
Model TS95C71X	Order No.: 331-1165



Modell TS95C71X  
Order No.: 331-1165

**READ THE INSTRUCTION BOOKLET BEFORE INSTALLING AND USING THE APPLIANCE.**

**The manufacturer will not be responsible for any damage to property or to persons caused by incorrect installation or improper use of the appliance.**

The manufacturer is not responsible for any inaccuracies, due to printing or transcription errors, contained in this booklet. In addition, the appearance of the figures reported is also purely indicative. The manufacturer reserves the right to make changes to its products when considered necessary and useful, without affecting the essential safety and operating characteristics.

## CONTENTS:

INSTALLER TECHNICAL MANUAL .....	pg. 2
Installing the cooker - Installation information .....	pg.3
Ventilation and aeration of rooms .....	pg. 3
Height-adjustable feet and Installing the toe-kick panel and the riser / back frame.....	pg. 3
Installing the system to prevent overturning.....	pg. 3
Gas connection and adaptation to different types of Gas and burner adjustments.....	pg. 4
Electric connection.....	pg. 5-6
APPLIANCE MAINTENANCE Attention: important warning - Replacing parts .....	pg. 6
USE AND MAINTENANCE MANUAL.....	pg. 7
Description of control panel and control types .....	pg. 7
Using burners .....	pg. 7-8
Using the hot plates .....	pg. 8
Using the ceramic hob .....	pg. 8-9
Using the induction hob .....	pg. 9-10
Using the gas oven .....	pg. 11
Using the change-over switch.....	pg. 12
Using the electric thermostat .....	pg. 12
Using the multifunction oven.....	pg. 12-13
Using the natural conventional .....	pg. 14
Using the ventilated electric oven .....	pg. 14-15
Using the gas grill and the conventional electric grill .....	pg. 15-16
Using the ventilated electric grill .....	pg. 15-16
Using the minute minder and the end of cooking timer and the digital clock .....	pg. 16-17
Using the touch clock and the analogic clock .....	pg. 17-18
Using the electronic timer programmer and the 3 keys electronic programmer .....	pg. 18-19
Using the thermometer .....	pg. 19
Using the self-cleaning oven and cleaning the appliance .....	pg. 20
After-sales technical service and spare parts .....	pg. 20
Packaging disposal .....	pg. 28

## THIS APPLIANCE HAS BEEN DESIGNED FOR NON-PROFESSIONAL DOMESTIC USE

### INSTALLER TECHNICAL MANUAL

This appliance is marked according to the European directive 2011/65/EU (RoHS)



This appliance is marked according to the European directive 2012/19/EU on Waste Electrical and Electronic Equipment (WEEE).

This guideline is the frame of a European-wide validity of return and recycling on Waste Electrical and Electronic Equipment.

### WARNING:

- The appliance and its accessible parts become very hot during use. Care must be careful not to touch the heating elements. Children under 8 years old must be kept away if not constantly supervised
- This appliance can be used by persons with reduced physical, sensory or mental capabilities, provided that they are supervised by someone who understand the use instructions and the risks involved.
- Children must not play with the appliance Cleaning and maintenance should not be undertaken by children unsupervised.
- Use only the recommended thermal probe for this oven
- Do not use steam cleaners for cleaning

**ATTENTION:** make sure the appliance is switched off before replacing the bulb to prevent possibility of electric shock

#### For cookers with electric ovens

- The appliance becomes hot during use. Do not touch the heating elements inside the oven

**ATTENTION:** The accessible parts can become very hot during use. Young children must be kept away

#### For glass doors:

- Do not use abrasive cleaning products or metal spatulas with sharp edges to clean the glass of the oven door since this could scratch the surface and the glass could break.

#### For cookers with glass covers

**ATTENTION:** Before opening the appliance's glass cover, carefully remove all liquid residues from the top of it.

**ATTENTION:** Before closing the appliance's glass cover, make sure that the work surface has cooled..

## INSTALLER INFORMATION

The installation, all adjustments, transformations and maintenance listed in this part of the manual must be carried out only by skilled personnel.

Improper installation may cause damage to persons, animals or property, for which the manufacture will not be held responsible.

The appliance safety or automatic adjustment devices may be changed during the service life of the system only by the manufacturer or by the duly authorised supplier.

### INSTALLING THE COOKER

After having removed the various loose parts from the internal and external packing, make sure that the cooker is not damaged. In case of doubt, do not use the appliance and contact skilled personnel.

**Keep all the dangerous packing parts (polystyrene foam, bags, cardboard, staples, etc.) away from children.**

**The appliance can be installed as a freestanding unit, next to a wall at a distance of no less than 20mm (fig.2-Class 1 Installation) or inserted between two walls (fig 1-Class 2 Subclass 1 Installation). A single sidewall that exceeds the height of the work surface is possible. This must be at a minimum distance of 70 mm from the edge of the cooker (fig. 2Class 1 Installation).**

Any walls of the adjacent furniture pieces and the wall behind the cooker must be made with heat-resistant material that can withstand a minimum over temperature of 65 K.

**The appliance can be installed as class 1 and as class 2 subclass 1.**

**WARNING: when the appliance is installed as class 2 subclass 1, the connection to the gas network must only use metal flexible pipes that conform with the national standards in force.**

### IMPORTANT INFORMATION FOR INSTALLING THE APPLIANCE

**The cooker can be installed separately, as a freestanding unit, or between kitchen units or between a kitchen unit and the wall. The device must be installed in accordance with the regulations stated in UNI 7129 and UNI 7131 standards.**

**This appliance is not connected to devices which exhaust combustion products.**

**Special attention must be focused on the prescriptions described below regarding room aeration and ventilation. Any hanging cabinets installed above the work surface must be located at a distance of no less than 700 mm.**

### ROOM VENTILATION

To ensure that the appliance operate correctly, the room where it is installed must be continuously ventilated. The room volume should not be less than 25 m<sup>3</sup> and the quantity of air needed shall be based on the regular combustion of gas and on the ventilation of the room. Natural air will flow through permanent openings in the walls of the room to be ventilated: these openings will be connected with the outside environment and shall have a minimum cross-section defined by the current national standards regarding room ventilation (see Fig. 3).

These openings shall be built so that they cannot be clogged.

Indirect ventilation is also permitted by taking air from the rooms adjacent to the one to be ventilated.

### LOCATION AND AERATION

The gas cooking appliances must always evacuate the combustion products by means of hoods connected to chimneys, flues or directly outside (see Fig. 4). If a hood cannot be installed, it is possible to use a fan installed on a window or directly facing outdoors, to be operated together with the appliance (see Fig. 5), provided that there is strict compliance with the ventilation regulations.

#### HEIGHT-ADJUSTABLE FEET (Fig.6)

**(The feet are packed in the top box)**

The feet should be installed with the cooker close to its final installation position; the feet are not safe to move the cooker long distances. After unpacking the cooker, lift it with your foot, to fit the cooker feet in the bases at the bottom. Slowly lower the cooker so its weight is resting on the feet and on the assembly fixings. We recommend using a lifting device or pallet instead of tilting the cooker (see instruction sheet in the supplied package)..

#### INSTALLING THE TOEKICK PANEL (only available for some models)

After installing the feet, install the cooker skirt as shown in the pictures in Fig. 7 (see instruction sheet in the supplied package).

#### INSTALLING THE RISER / BACK FRAME

see instruction sheet in the supplied package.

#### INSTALLING THE SYSTEM TO PREVENT OVERTURNING

To prevent the appliance from accidentally overturning, the system provided must be installed. Install the system as shown in the figures. Figures 9-10

## APPLIANCE GAS CONNECTION

Before connecting the appliance to the gas network, make sure that the data on the label attached to the food warmer drawer or on the back of the cooker are compatible with what is indicated for the gas distribution network.

A label attached to the last page of this handbook and in the food warmer drawer (or on the back) of the appliance indicates the appliance adjustment conditions: type of gas and operating pressure.

**IMPORTANT:** This appliance must be installed in compliance with current national standards in force and used only in a well-ventilated room.

**WARNING:** It should be recalled that the appliance utilises a threaded 1/2" gas cylindrical male fitting according to UNI-ISO 228-1.

To connect the appliance to the gas network with a flexible rubber hose, a supplemental hose nipple fitting is needed (see Fig. 11) which is supplied with the appliance.

### ADAPTATION TO DIFFERENT TYPES OF GAS

Before performing any maintenance operation, disconnect the appliance from the gas supply and electricity network.

**REPLACING THE NOZZLES TO OPERATE WITH ANOTHER TYPE OF GAS:**

**Follow the instructions below to change the burner nozzles on the work surface:**

- 1) Pull out the plug from the electric outlet to avoid any type of electric contact.
- 2) Remove the grids from the work surface (Fig. 12).
- 3) Remove the burners (Fig. 12).
- 4) Unscrew the nozzles using a 7 mm spanner, and replace them (Fig. 13) with those needed for the new type of gas according to what is indicated in Table 1.

**Follow the instructions below to change the oven burner nozzle:**

- 1) Remove the oven level (Fig. 14-15).
- 2) Loosen the screw **V** and pull out the burner from the support being careful not to damage the ignition plug and the thermocouple (Fig. 16).
- 3) Unscrew the nozzle **R** (Fig. 16) using a 10 mm spanner and replace it with the nozzle needed for the new type of gas according to what is indicated in Table 2.

**Follow the instructions below to change the grill burner nozzle:**

- 1) Loosen the screw at the end of the grill burner and pull out the burner from the support being careful not to damage the ignition plug and the thermocouple (Fig. 17).
- 2) Unscrew the nozzle **R** (Fig. 17) using a 7 mm spanner and replace it with the nozzle needed for the new type of gas according to what is indicated in Table 2.

**WARNING:** After completing the above-mentioned replacements, the technician must adjust the burners, as described in the paragraph below, seal any adjustment and pre-adjustment devices and apply the label on the appliance, to replace the existing one, corresponding to the new gas adjustment. This label is contained in the spare nozzle bag.

**Table 1**

APPLIANCE CATEGORY: II2H3+

Burner	Types of gas	Pressure	Nozzle diameter	Rater capacity				Reduced Capacity		By-pass Diameter
		mbar	1/100 mm.	g/h	l/h	kW	kcal/h	kW	kcal/h	1/100 mm.
Auxiliary	Natural G20	20	72	-	95	1	860	0,48	413	34 reg.
	Butane G30	30	50	73	-	1	860	0,48	413	34
	Propane G31	37	50	71	-	1	860	0,48	413	34
Semi-rapid	Natural G20	20	97	-	167	1,75	1505	0,60	516	36 reg.
	Butane G30	30	65	127	-	1,75	1505	0,60	516	36
	Propane G31	37	65	125	-	1,75	1505	0,60	516	36
Rapid	Natural G20	20	115	-	286	3	2580	1,05	903	52 reg.
	Butane G30	30	85	218	-	3	2580	1,05	903	52
	Propane G31	37	85	214	-	3	2580	1,05	903	52
Ultra rapid 4 kW	Natural G20	20	153	-	405	4,25	3655	1,80	1548	65 reg
	Butane G30	30	102	309	-	4,25	3655	1,80	1548	65
	Propane G31	37	102	303	-	4,25	3655	1,80	1548	65
Ultra rapid Dual 5 kW	Natural G20	20	ext. 155 int. 70	-	476	5	4300	0,48	413	ext. 65 reg. Int. 34 reg.
	Butane G30	30	ext. 96 int. 46	334	-	4,60	3956	0,48	413	ext. 65 Int. 34
	Propane G31	37	ext. 96 int. 46	328	-	4,60	3956	0,48	413	ext. 65 Int. 34
		-	-	-	-	-	-	-	-	-

**Table 2 (model with gas oven and gas grill with single control, or gas oven and electric grill)**

Oven	Natural G20	20	155	-	429	4,50	3870	0	65 reg.
	Butane G30	30	105	327	-	4,50	3870	0	65
	Propane G31	37	105	321	-	4,50	3870	0	65
Grill	Natural G20	20	108	-	191	2	1720	0	-
	Butane G30	30	72	145	-	2	1720	0	-
	Propane G31	37	72	143	-	2	1720	0	-

## BURNER ADJUSTMENT

### 1) Burner "MINIMUM" adjustment:

**Work surface burner adjustment:** follow the instructions below to adjust the work surface burner minimum:

- 1) Light the burner and set the knob to the MINIMUM position (small flame).
- 2) Remove the knob of the valve that is press fit on the rod of that valve.
- 3) If the cooker is not equipped with safety valves on the surface burners, insert a small slotted screwdriver into the hole on the valve rod (Fig. 18) and turn the choke screw to the right or left until the burner flame is adjusted to minimum. If the cooker is equipped with safety valves, the choke valve is not located in the rod hole, but on the valve body (see fig. 19).
- 4) For the gas valve of dual burner the choke valve is located on the valve body (fig.20), the A screw adjust the outer ring, the B screw adjust the inner ring.
- 5) Make sure that the flame does not go out when switching quickly from the MAXIMUM to the MINIMUM position.

**Oven burner adjustment:** follow the instructions below to adjust the minimum:

- 1) Light the burner setting the knob to the MAXIMUM position.
- 2) Close the oven door and operate the oven for at least 10 minutes.
- 3) Set the knob to the MINIMUM position (corresponding to 120°) and then remove it.
- 4) With a slotted screwdriver turn the choking screw (see figure 21) and, while observing the flame at the same time through the cooker porthole, evaluate the consistency of the flame so it remains on when switching quickly from the MINIMUM to the MAXIMUM position.

**Grill burner adjustment:** follow the instructions below to adjust the minimum:

- 1) Light the burner setting the knob to the MAXIMUM position.
- 2) Close the oven door and operate the oven for at least 10 minutes.
- 3) Set the knob to the MINIMUM position (small flame) and then remove it.
- 4) If the cooker is not equipped with safety valves on the surface burners, insert a small slotted screwdriver into the hole on the valve rod (Fig. 18) and turn the choke screw to the right or left, while observing the flame at the same time through the cooker porthole, evaluate the consistency of the flame so it remains on when switching quickly from the MINIMUM to the MAXIMUM position. If the cooker is equipped with safety valves, the choke valve is not located in the rod hole, but on the valve body (see figure 21).

**WARNING: The above-mentioned adjustment should be made only with natural gas burners, while for those operating with liquid gas the screw must be locked at the end in a clockwise direction.**

**WARNING: For the model with single grill burner, the grill burner always operates at maximum and therefore no minimum adjustment is required.**

## APPLIANCE ELECTRIC CONNECTION:

**The electric connection must comply with the current legal standards and regulations.**

Before making the connection, check that:

- The system electrical rating and the current outlets are adequate for the maximum power output of the appliance (see the label applied to the bottom of the casing).
- The outlet or the system is equipped with an efficient ground connection in accordance with the current legal standards and regulations. The company will not be responsible for the non-compliance with these instructions.

**When the connection to the power supply network is made using an outlet:**

-If the power cord is supplied without a plug, apply a standard plug that is suitable for the load indicated on the label. Connect the wires according to the diagram shown in FIG.22 and check that:

**letter L (phase) = brown wire;**

**letter N (neutral) = blue wire;**

**ground symbol = green-yellow wire;**

- The power cord must be positioned so that an overtemperature of 75 K will not be reached at any point.
- Do not use reductions, adapters or splitters since they might cause false contacts and lead to dangerous overheating.

**When the connection is made directly to the electric network:**

- Insert an omnipolar circuit-breaker between the appliance and the network which is sized for the appliance load with a minimum opening between the contacts of 3 mm.
- Remember that the ground wire must not be interrupted by the circuit-breaker.
- As an alternative, the electric connection can also be protected by a high-sensitivity residual current circuit-breaker.
- It is highly recommended to attach the special green-yellow ground wire to an efficient ground system.

**WARNING: If the power cord is replaced, the ground wire (yellow-green) connected to the terminal, should be longer than the other wires by about 2 cm.**

TABLE N°3 : TYPES OF POWER CORDS

Work surface operation	Oven operation	Cross section			
		230V ~	230V 3~	400V 2N~	400V 3N~
Only gas burner	Gas oven / Gas grill	3x0.75mm <sup>2</sup>	-	-	-
	Gas oven / Electric grill	3x1mm <sup>2</sup>	-	-	-
	Ventilated Electric Oven	3x1,5mm <sup>2</sup>	-	-	-
Gas burner + 1 hot plate	Gas oven / Gas grill	3x1mm <sup>2</sup>	-	-	-
	Gas oven / Electric grill	3x1,5mm <sup>2</sup> (M6) 3x2,5mm <sup>2</sup> (M9)	-	-	-
	Ventilated Electric Oven	3x2,5mm <sup>2</sup>	-	-	-
Gas burner + 2 hot plate	Forno elettrico ventilato multi-9	3x2,5mm <sup>2</sup>	4x1,5mm <sup>2</sup>	4x1,5mm <sup>2</sup>	5x1,5mm <sup>2</sup>
	Induction	Forno elettrico ventilato multi-9	3x2,5mm <sup>2</sup>	4x1,5mm <sup>2</sup>	5x1,5mm <sup>2</sup>
Ceran	Forno elettrico ventilato multi-9	3x4mm <sup>2</sup>	4x1,5mm <sup>2</sup>	4x1,5mm <sup>2</sup>	5x1,5mm <sup>2</sup>

**ATTENTION:** By placing the  marking on this product, we declare, on our own responsibility, compliance to all of European safety, health and environmental requirements stated in the legislation for this product.

### THREE-PHASE ELECTRIC CONNECTION

The cookers that can also be connected to three-phase systems normally are factory built for the single-phase 230V connection and are supplied with a power cord. Based on the connection system used, install the power cord type indicated in table No.3. To use the selected connection system change the jumpers on the terminal strip as indicated in the diagram of Fig.23

### APPLIANCE MAINTENANCE ATTENTION: IMPORTANT WARNINGS

#### For cookers resting on a base

ATTENTION: If the cooker rests on a base, take the measures necessary to prevent the cooker from sliding along the support base.

#### For cookers with glass covers

ATTENTION: Before opening the appliance's glass cover, carefully remove all liquid residues from the top of it.

ATTENTION: Before closing the appliance's glass cover, make sure that the work surface has cooled.

#### For cookers with electric ovens

The unit becomes hot during use. Do not touch the heating elements inside the oven.

#### For cookers with electric ovens

ATTENTION: The accessible parts can become hot during use. Keep children away from the appliance.

#### For the food warmer compartment (or drop leaf in our case)

ATTENTION: The internal parts of the food warmer can become hot during use.

#### For glass doors

Do not use abrasive cleaning products or metal spatulas with sharp edges to clean the oven door's glass since this could scratch the surface and the glass could break.

#### Do not use steam cleaners to clean the appliance.

**NOTE:** various parts of the cooker heat up reaching temperatures which seem very high but which are actually fully within safety limits. According to these limits:

1) With the oven on at 200°C for 1 hour, front accessible parts which cannot be grasped, can reach the following temperatures:

- Control panel: Tmax = Room Temperature +60°C
- Glass of the oven door: Tmax = Room temperature+60°C
- Metal part of the oven door: Tmax = Room temperature+45°C

2) With the oven on at 230°C for 1 hour, the parts which can be grasped, can reach the following temperatures:

- Plastic knobs: Tmax = Room temperature+60°C
- Metal oven door handle: Tmax = Room temperature+35°C

where the room temperature is the temperature in °C of the place where the appliance is installed.

### REPLACING PARTS

#### Before performing any maintenance operation, disconnect the appliance from the gas supply and electricity network.

To replace parts such as knobs and burners, just remove them from the seats without disassembling any part of the cooker.

To replace parts such as nozzle supports, valves and electric components follow the procedure described in the burner adjustment paragraph. To replace the valve or the gas thermostat, it is also necessary to disassemble the two rear gas train brackets, loosening the 4 screws (2 per bracket) that attach it to the rest of the cooker and, unscrew the nuts that attach the front burner valves to the control support, after removing all the knobs. To replace the gas or electric thermostat, also disassemble the rear cooker guard, loosening the relative screws, to be able to pull out and reposition the thermostat bulb.

To replace the oven bulb, just unscrew the protection cap that projects out inside the oven.(fig.24)

#### WARNING: Before replacing the bulb, disconnect the appliance from the electric power supply.

**WARNING:** The power cord supplied with the appliance is connected to that appliance with an X type connection (in compliance with standards EN 60335-1, EN 60335-2-6 and subsequent amendments) for which it can be installed without the use of special tools, with the same type of cord as the one installed.

If the power cord becomes worn or damaged, replace it based on the information reported in table 3 .

**WARNING: If the power cord is replaced, the installer shall ensure that the ground cable is longer than the phase cables and also shall comply with the warnings regarding the electric connection.**

## USE AND MAINTENANCE MANUAL

### GAS BURNER DIMENSION

Burner	Dimension (mm)
Auxiliary	Ø 50
Semi-rapid	Ø 70
Rapid	Ø 95
Ultra-rapid	Ø 125
Ultra-rapid dual	Ø 135

### ELECTRIC HOT PLATE DIMENSION

TIPE OF PLATE	DIMENSION
Electric hot plate	Ø 145
Electric hot plate	Ø 180

### CONTROL PANEL DESCRIPTION

On the control panel, small symbols show the function of each knob or key. Here as follows are the several controls that a cooker can have:

the symbol  shows the disposition of burners on the worktop, the full dot identifies the burner in object (in this case the rear burner on the right).

the symbol  shows the running of any oven (gas oven, gas oven with gas grill, gas oven with electric grill and multifunction oven)

the symbol  shows the grill (gas grill, electric grill)

the symbol  shows the electric thermostat for electric fan oven.

the symbol  shows the oven fan working button as to allow the oven to operate with fan assisted gas. The fan operation of the oven prevents the operation of the grill, which therefore cannot be used with the fan in action.

the symbol  shows the minute minder

the symbol  shows the operating key for the rotisserie (only gas oven)

the symbol  shows the ignition key for the oven light (all except the electric fan oven)

the symbol  shows the push-button for burner ignition

the symbol  shows if keys are in position "on" or "off"

### USING BURNERS

A diagram is etched on the control panel above each knob which indicates which burner corresponds to that knob. The burners can be ignited in different ways depending on the type of appliance and its specific characteristics:

- **Manual lighting (it is always possible even when the power is cut off):** Turn the knob counterclockwise that corresponds to the burner selected, setting it to the MAXIMUM position at the etched star (large flame Fig.25) and place a lit match up to the burner.

- **Electric ignition:** Turn the knob counterclockwise that corresponds to the burner selected, setting it to the MAXIMUM position (large flame Fig. 25) and keep on pressing the knob in correspondence of the ignition symbol marked with a star (for cookers equipped with ignition trough knob) or press the ignition button marked with a star and release it as soon as the burner has ignited.

- **Burner ignition equipped with safety device (thermocouple)(Fig.26):** Press and turn the knob counterclockwise that corresponds to the burner selected, setting it to the MAXIMUM position at the etched star (large flame Fig. 25), press the knob and activate one of the above-mentioned ignition devices. Once ignited, keep pressing the knob for about 10 seconds to allow the flame to heat the thermocouple. If the burner goes out after releasing the knob, repeat the entire operation.

Note: It is recommended not to try to ignite a burner if the relative flame cap is not in the correct position.

#### -Use of the dual burner (Fig.27)

This model controls both the central and external crown of the burner with just one valve.

To ignite the central crown press and turn the knob to the maximum delivery position 1 and hold it down until ignition: in this position the internal flame are at maximum.

Turn the knob to position 2 to have the internal crown at the minimum.

Turn the knob to position 3 to have the internal crown ant the external crown at the maximum.

Turn the knob to position 4 to have the internal crown ant the external crown at the minimum.

#### Tips for using burners correctly:

- Use suitable pots for each burner (see tab. 4 and Fig.28).
- When the liquid is boiling, turn the knob to the MINIMUM position (small flame Fig. 25).
- Always use pots with a cover.

<b>BURNER</b>	<b>Recommended POT DIAMETERS (cm.)</b>
Auxiliary	12 – 14
Semi-rapid	14 – 26
Rapid	18 – 26
Ultra-rapid	22 – 26
Ultra-rapid dual	22 – 50

**WARNING: Use flat-bottomed containers**

**WARNING: After cleaning, make sure head “B” and covers “A” are properly placed on their seat as figure 29 and not off-center as in figure 29**

**WARNING: If the power is cut off, the burners can be lit with matches. When cooking foods with oil and fat, which are very flammable, the user should not leave the appliance unattended. If the appliance is equipped with a glass cover, such a cover may break when heated. Turn off all burners before lowering the cover. Do not use sprays near the appliance when it is being used.**

**When using the burners, make sure that the handles of the pots are correctly positioned. Keep children away from the appliance. If equipped with a cover, before being closed, any food deposits should be cleaned off the built-in surface.**

**NOTE: The use of a gas cooking appliance produces heat and humidity in the room where it is installed. Therefore, proper aeration in the room is needed while ensuring that natural ventilation openings remain unobstructed. Intensive and continuous use of the appliance may require additional aeration, for example by opening a window, or more efficient aeration by increasing the power of the mechanical exhauster, if installed.**

### USING HOT PLATES

These plates are controlled by a switch with 6 settings (see Fig.30). The plates are turned on by turning the knob to the desired position. The front panel of the appliance is etched with a mark indicating what plate corresponds to the knob. A light, which is also installed on the control panel turns on, indicating that the plate is on.

#### How to use a hot plate:

When a hot plate is used for the first time or after a long period of inactivity, it is recommended to use it on position 1 for about 30 minutes to eliminate any humidity absorbed by the internal insulating material.

As example, we have included a table with the adjustments needed to ensure proper use of the hot plates.

**WARNING: When a hot plate is used for the first time or after a long period of inactivity, it is necessary to use it on position 1 for about 30 minutes to eliminate any humidity absorbed by the insulating material.**

TABLE N°5

<b>PLATE</b>	<b>POSSIBLE COOKING METHODS</b>
0	Plate off
1	To melt butter, chocolate, etc. - To heat small amounts of liquid
2	To heat larger quantities of liquid - To prepare creams and sauces that required extended cooking
3	To defrost foods, cook at boiling temperature
4	To cook roasts with delicate meat and fish
5	For meat roasts and steaks, for large pieces of boiled meat
6	To boil large quantities of water, for frying.

**To ensure correct use, remember the following:**

- Dry the bottom of the pot before placing it on the plate.
- Use pots with a flat and thick bottom (see Fig. 31).
- Never use pots that are smaller than the plate.
- Turn on the plate only after the pot has been placed on top.
- As soon as a crack appears on the surface of the hot plate, immediately turn off the appliance.
- If the appliance is equipped with a glass cover, it may break when heated.
- Turn off all the plates before closing the cover.
- After use, and to ensure good preservation, the plate should be treated with normal products for electric hot plates that are available in the market so that the surface is always clean; this operation will prevent any corrosion (rust).
- After they are used, the plates remain hot for a long time; therefore, do not place the hands or other objects on the plate to avoid burns.
- When using the burners, make sure that the handles of the pots are correctly positioned. Keep children away from the appliance.
- When cooking foods with oil and fat, which are very flammable, the user should remain near the appliance.

**WARNING: As soon as a crack appears on the surface of the hot plate, immediately turn off the appliance.**

### USING THE CERAMIC HOB

The working table has 5 cooking areas, which differ in power and diameter (Fig.32).

Positions are clearly indicated with screen-printed round areas (see description of the hobs).

The heating process comes inside these areas.

When a worktop hotplate is used for some time, the remaining surface remain hot; a red indicator in the worktop surface light will indicate it.

To obtain best results, the bottom of the hob should be thick and flat.



The diameter of the bottom of the pot (or other container) should be as near as possible the diameter of the burner you are using; using a smaller pot will cause waste of energy due to heat dispersion on the uncovered surface of the plate. The hob surface and the bottom of the pot must be kept clean. Following these recommendations will help you save energy.

**CERAN HOT PLATE (Fig 32)**

TYPE OF PLATE	POWER
A) Ceramic electrical hot plate	left front 700/1700W
B) Ceramic electrical hot plate	left rear 1200W
D) Ceramic electrical hot plate	right rear 1100/2200W
E) Ceramic electrical hot plate	right front 1200W
C) Ceramic electrical hot plate	central 1400/2200W

**Residual heat**

Each cooking zone is equipped with a device which warns of residual heat (H). After any cooking zone is switched off, a red indication light may appear on the display. This warns that the cooking zone concerned is still very hot. (Fig.33)

**How to use the 5 electrical hot plate ceramic hob:**

Each worktop cooking hotplate is controlled by an energy regulator **switch (for 1 or 2 circuit type hotplate)**. These allow you to select different power rates in continuous way from the lower position "0" (plate always "off") to the higher position "3" (plate always "on"; double circuit hotplates control switch (Fig. 34) allow to reach the full power rate of the related double circuit hotplate by turning the related knob in 2<sup>nd</sup> circuit position for 1-2 sec. and the releasing it in pos.3 (Fig. 35)

Directions showing the hotplate and related control knob is indicated on the control panel of the appliance.

A red indication light on the worktop surface will indicate You that some worktop hotplate is turned on.

Once the boiling level has been reached, lower the temperature and let the food simmer.

Experience will guide you in understanding how long to simmer, but obviously this also depends on the food and the kind of pot you are using. Proper use will permit you to save time and energy.

**WARNING:**

**Under no circumstance use aluminium foil or plastic containers to hold the food while cooking on a glass-ceramic hob.**

**WARNING:**

**Do not touch the cooking area as long as the light indicating residual heat on the glass-ceramic hob, is "on"; this indicates that the temperature in the relative area is still high.**

**WARNING:**

**Your glass-ceramic hob is thermal shock resistant and resistant to both heat and cold.**

**If you drop a heavy pot on your hob it will not break.**

**On the contrary, if a hard object, such as the salt shaker or the spice bottle strikes the edge or the corner of the hob, the hob may break.**

**WARNING: never use the glass-ceramic hob as support surface.**

**TYPE OF PAN**

The pans used for cooking must have certain minimum diameters to ensure satisfactory operation.

Pans larger than the cooking zones can also be used, but it is important to ensure that the bottom of the pan does not touch other cooking zones, and that it is always centred over the perimeter of the cooking zone.(fig.36-37)

The pans used must not have crowned (concave or convex) bottom. (fig.38)

**USING THE INDUCTION HOB  
HOB CONTROL KNOB**

These knobs provide control of the ceramic hob's cooking zones.

The zone it controls is shown above each knob. Turn the knob to the right to set the zone's operating power; the settings range from a minimum of 1 to a maximum of 9. (fig. 39)

The working power is shown by a display on the hob.

**Heating accelerator**

Each cooking zone is equipped with a heating accelerator.

This system allows the zone to be operated at peak power for a time proportional to the heating power selected.

To start the heating accelerator, turn the knob to the left, select setting "A" and then release. The letter "A" will appear on the display on the hob.

You now have 3 seconds to select the heating setting of your choice. Once a setting between 1 and 9 has been selected, "A" and the chosen setting will flash in alternation on the display. '

While the heating accelerator is in operation, the heating level can be increased at any time. The "full power" time will be modified accordingly. If the power is reduced by turning the knob anticlockwise, option "A" is automatically deactivated.

**Power Function**

The power function allows the user to operate each heating zone continuously at the maximum power for a time of no more than 10 minutes. This function can be used, for example, to bring a large amount of water to the boil in a hurry, or to turn up the heat under meat.

Turn the knob clockwise and set heating level 9, then use the knob to set the "P" position and release il. "P" appears on the corresponding zone display.

After 10 minutes, the power is reduced automatically, the knob returns to the 9 setting and the "P" disappears.

However, the power function can be turned off at any time by reducing the heating level. .

When the power function is selected for one heating zone (e.g. the left front zone), the power absorbed by the second zone (left rear zone) might be reduced to supply the maximum available energy to the first zone. Consequently, the power function takes priority over the heating accelerator. If a pan is removed from the cooking zone while the power function is on, the function is switched off.

## HOB

### ATTENTION:

Metal items such as cutlery or lids must never be placed on the surface of the hob since they may become hot.

### Cooking zones (fig.40)

The appliance is equipped with 5 cooking zones having different diameters and powers. Their positions are clearly marked by rings, while the heating power is only released in the area shown on the ceramic hob. The 5 cooking zones are of HIGH-LIGHT type and start to heat up a few seconds after they are switched on. The heat level of each zone can be regulated from the minimum to the maximum setting using the knobs on the front panel.

Underneath each cooking zone there is a coil called an *inductor*, supplied with power by an electronic system, which generates a variable magnetic field. When a pan is placed inside this magnetic field, the high frequency currents concentrate directly on the bottom of the pan and produce the heat needed to cook the foods.

The 5 lights between the cooking zones come on when the temperature of one or more cooking zones exceeds 60° C.. The lights go out when the temperature drops to below about 60° C.

Zone number:	Power absorption	
	Normal operation:	With power function:
1	1100W	1400W
2	1100W	1400W
3	1400W	2000W
4	2300W	3000W
5	2300W	3000W
Total power absorption		7400W

When the hob is used for the first time, it should be heated to its maximum temperature for long enough to bum off any oily residues left by the manufacturing process, which might contaminate foods with unpleasant smells.

### TYPES OF PANS

This type of appliance can only operate with pans of special kinds.

The bottom of the pan must be iron or steel/iron to generate the magnetic field necessary for the heating process.

Vessels made from the following materials are not suitable:

- glass;
- porcelain;
- pottery;
- steel, aluminium or copper without magnetic bottom;

To check that a pan is suitable, simply place a magnet close to its bottom:

if the magnet is attracted, the pan is suitable for induction cooking. If no magnet is to hand, put a little water in the pan, place it on a cooking zone and switch it on. If the symbol appears on the display instead of the power, the pan is not suitable.

The pans used for cooking must have certain minimum diameters to ensure satisfactory operation.

Pans larger than the cooking zones can also be used, but it is important to ensure that the bottom of the pan does not touch other cooking zones, and that it is always centred over the perimeter of the cooking zone.(fig.36-37)

Use only vessels specially designed for induction cooking, with thick, completely flat bottom; if these are not available, the pans used must not have crowned (concave or convex) bottom. (fig.38)

### Pan present device

Each cooking zone is equipped with a "pan present" device, which ensures that cooking cannot start unless a suitable pan is present on the cooking zone and properly positioned.

If the user attempts to switch on the cooking zone with the pan not positioned properly or with a pan which is not of suitable material, a few seconds after the zone is switched on the  symbol will appear to warn the user that an error has been made.

### Residual heat

Each cooking zone is equipped with a device which warns of residual heat. After any cooking zone is switched off, a flashing 'H' may appear on the display. This warns that the cooking zone concerned is still very hot. Cooking can be restarted while the 'H' is flashing; proceed as described in point "3".

### Locking-out the hob

When not in use, the hob can be "locked out" to prevent children from accidentally switching it on.

With the cooking zones off, turn the knobs of zones 2 and 4 to the left simultaneously until 5 Ls appear on the power display and then release the knobs.

To deactivate it, repeat the same procedure: the cooking zone displays will all show 0, indicating that the cooking zone lock-out function has been deactivated.

**Attention:** Take care not to spill sugar or sweet mixtures onto the hob during cooking, or to place materials or substances which might melt (plastic or aluminium foil) on it; if this should occur, to avoid damage to the surface, turn the heating off immediately and clean with the scraper supplied while the cooking zone is still warm. If the ceramic hob is not cleaned immediately, residues may form which cannot be removed once the hob has cooled.

### Important!

Keep a close eye on children because they are unlikely to see the residual heat warning lights. The cooking zones are still very

hot for some time after use, even if they are switched off. Make sure that children never touch them.

**WARNING:** Under no circumstance use aluminium foil or plastic containers to hold the food while cooking on a glass-ceramic hob.

**WARNING:** Do not touch the cooking area as long as the light indicating residual heat on the glass-ceramic hob, is “on”; this indicates that the temperature in the relative area is still high.

**WARNING:** Never place pan with bottoms which are not perfectly flat and smooth on the hob

**WARNING:** If you notice a crack in the ceramic hob, disconnect the appliance from the electricity supply and contact a service centre

**WARNING:** Your glass-ceramic hob is thermal shock resistant and resistant to both heat and cold.

If you drop a heavy pot on your hob it will not break.

On the contrary, if a hard object, such as the salt shaker or the spice bottle strikes the edge or the corner of the hob, the hob may break.

**WARNING:** never use the glass-ceramic hob as support surface

### USING THE GAS OVEN

#### GAS OVEN:

All the gas oven cookers are equipped with a thermostat and safety device to adjust the cooking temperature. The oven temperature is set by turning the knob counterclockwise to match the indicator with the temperature selected. The gas oven can be combined with a gas grill or an electric grill. See the specific pages for use information.

#### FAN GAS OVEN:

Operating the fan of the oven by means of the appropriate switch situated on the control panel, the circulation of warm air guarantees a uniform heat distribution. The preheating of the oven can be avoided. However for delicate baking, it is preferable to warm the oven before introducing the baking-pan. The baking system with the fan convection changes in part the various traditional baking notions. When roasting meat it is not necessary to turn the meat any more and for a roast on the spit, it is not indispensable to use the spit-roaster, but is sufficient to put the meat directly on the grate.

With the use of the fan gas oven, the baking temperatures are slightly lower of about 10-15°C compared to those in use with the traditional gas oven. The fan operation of the oven prevents the operation of the grill, which therefore cannot be used with the fan in action.

The oven can also be used in a traditional way, (by not activating the fan) for foods requiring heat from the bottom, e.g. pizza.

**WARNING: If the burner flames are extinguished accidentally, turn off the control knob and do not try to relight the oven until after at least 1 minute.**

TABLE N°6

THERMOSTAT SETTING	TEMPERATURE °C
1	120°C
2	140°C
3	160°C
4	180°C
5	200°C
6	225°C
7	245°C
8	270°C

The oven burner can be ignited in different ways:

- **Manual lighting** (it is always possible even when the power is cut off):

To light the oven, open the oven door and turn the knob so the no. 8 on the scale matches the indicator (fig.41-42). At the same time put a lit match next to the ignition tube that is visible on the oven level (fig.43). Then press the thermostat knob (this makes the gas start to flow) and keep it pressed, after the burner has been completely lit, for 10 seconds. Release the knob and make sure that the burner remains on, otherwise repeat the operation.

- **Electric ignition** (only for the models equipped with this device):

In this case, first open the oven door, then press and turn the knob to the maximum temperature setting Then press the thermostat knob (models with ignition trough knob). Wait about 10 seconds after the burner has been completely lit and then release the knob. Make sure that the burner remains on, otherwise repeat the operation. As for cookers without ignition trough knob, press the thermostat knob and the key with the spark symbol, wait about 10 seconds after the burner has been completely lit and then release the knob. Make sure that the burner remains on, otherwise repeat the operation.

**The ignition device should not be used for more than 15 seconds. If after that period the burner still has not been lit, do not use the device and open the door of the room or wait at least 60 seconds before trying to light the oven again.**

**WARNING: when trying to light the oven, the door must always be open. When using the oven, leave the cooker cover open to prevent it from overheating.**

**NOTICE: when using the oven for the first time it should be operated for 15-30 minutes at a temperature of about 250° without cooking anything inside in order to eliminate any moisture and odours from the internal insulation.**





During normal oven use, after lighting the burner and setting the desired temperature, wait about 15 minutes before putting in any food to preheat the oven. The oven is equipped with 5 guides (Fig.44) at different heights which can be used to insert shelves or the tray. To keep the oven as clean as possible it is recommended to cook meat on the tray or on the shelf that has been inserted inside the tray.

TABLE N°7

GAS OVEN COOKING TABLE			
	TEMP °C	HEIGHT	MINUTES
<b>MEAT</b>			
PORK ROAST	220 (210)	2	60-70
BEEF ROAST (YOUNG STEER)	250 (240)	2	50-60
BEEF ROAST	240 (230)	2	60-70
VEAL ROAST	220 (210)	2	60-70
LAMB ROAST	220 (210)	2	45-55
ROAST BEEF	230 (230)	2	55-65
ROAST HARE	235 (225)	2	40-50
ROAST RABBIT	220 (210)	2	50-60
ROAST TURKEY	235 (225)	2	50-60
ROAST GOOSE	225 (215)	2	60-70
ROAST DUCK	235 (225)	2	45-60
ROAST CHICKEN	235 (225)	2	40-45
<b>FISH</b>			
	200-225 (190-215)	3	15-25
<b>PASTRY</b>			
FRUIT PIE	200 (210)	3	35-40
TEA CAKE	190 (180)	3	50-55
BRIOCHES	175 (165)	3	25-30
SPONGE CAKE	235 (225)	3	20
RING CAKE	190 (180)	3	30-40
SWEET PUFF PASTRIES	220 (210)	3	20
RAISIN LOAF	220 (210)	3	15-20
STRUDEL	180 (170)	3	15-20
SAVOIA COOKIES	190 (180)	3	15
APPLE FRITTERS	220 (210)	3	20
SAZOIARDI SANDWICH	220 (210)	3	20-30
TOAST SANDWICH	250 (240)	2	5
BREAD	220 (210)	3	30
PIZZA	220 (210)	3	20

### USING THE CHANGE-OVER SWITCH (Fig45-46-47) (only for gas ovens with electric grill)

The 2+0 change-over switch used for gas oven models with electric grill

- the symbol  and  is for oven fan and light operation, to use the gas oven or electric grill with fan.
- the symbol  and  is for oven turnspit and light operation;
- the symbol  is for turning on the oven light

### USING THE ELECTRIC THERMOSTAT (Fig.48)(WITH A MULTIFUNCTION OVEN)

The thermostat supplied with the relative models maintains a constant temperature inside the oven at a specific temperature setting ranging from 50°C to 250°C.

Turn the knob clockwise and align the selected temperature indicated on the ring with the index etched on the control panel. Thermostat operation is indicated by an orange light which will turn off when the temperature inside the oven is 10°C greater than the temperature setting, and will turn on when the oven is 10°C less than the temperature setting. The thermostat can control the oven elements only if the relative switch is in one of the possible oven element operating modes: if the switch is in position 0, the thermostat has not effect on the oven elements, which remain off.

### USING THE MULTIFUNCTION OVEN (Fig.49)

#### Before using the ovens for the first time:

- Remove all packaging and accessories from inside the ovens.
- Heat the ovens to 200°C for ½ hour to burn off manufacturing residues.
- The automatic programmer must be set to Manual mode for ordinary cooking.
- The oven will not function when set in Automatic mode. See page 17

#### To use the ovens:

**1** Turn the function selector knob (Fig.49) clockwise to the desired function.

The orange light will illuminate, indicating that the element is on.

**2** Turn the temperature selector knob (Fig.48) clockwise to the desired temperature. The orange light will go out once the oven has reached temperature and is ready for use. It is normal for this light to go on and off during cooking as the elements maintain

the temperature.

**3** To turn the oven off, turn the function selector and temperature knobs anti- clockwise back to •.

Steam may be generated when cooking. As a precaution, always open the door in two stages. First, partially open the door by 100mm for a few seconds to allow the steam to escape, then open the door fully. Keep your face and head away from the door when opening.

Never line the oven interior with foil as this can cause overheating and damage the enamel. Never cook on the oven base. Always place dishes and trays onto an oven shelf. Do not leave the grill pan or other dishes on the oven base as damage to the oven may occur.

**Preheating the oven:**

'Quickstart' provides the most efficient and fastest way to preheat the main oven (left hand oven). It will also ensure your oven cooks evenly. Use 'Quickstart' as follows :

1 Select 'Quickstart' (using the oven function selector) and the required cooking temperature (using the temperature selector). Allow the orange thermostat light to come on and off several times. This allows the temperature to stabilize before introducing food .

2 Select the recurred cooking function and place the food in the oven.

3 When preparing heat sensitive foods such as cakes or meringues using the 'True Fan' function, allow the orange light to come on and off again several times to allow the top element to cool slightly.

'Quickstart' is unsuitable for use as a cooking function It is a quick pre-heat system.

**OVEN FUNCTIONS**

When using any of the functions in the multifunction oven (except grilling and defrosting) it is always recommended that you pre-heat the oven using the Quick start function, before switching over to your desired cooking function.







When using the Fan Assisted or True Fan oven function, it is advisable to reduce the oven temperature by 20°C if following a recipe written for a conventional oven. Check the food often through the latter stages of cooking until you are used to the cooking times and temperatures.



The ovens have a range of cooking functions providing different heat zones. The 'True Fan' function for instance, is most suitable for cakes, desserts and batch baking. The ' Fan Assisted' function gives more browning so is more suitable for roasting meats and vegetables or frozen potato products.

**Example: To cook a turkey:**

When cooking a turkey, the grill pan can be used as a roasting tin Line the pan with a double layer of extra wide foil, allowing enough foil to wrap the turkey loosely. It is important to allow enough space around the sides and top of the oven for the hot air to circulate. Make sure that the foil is not touching the sides or top of the oven. In a 60cm oven a turkey of 9 to 11 kg can be cooked. In a 40cm oven a turkey of 6 – 9 kg can be cooked.

The oven light operates on selection of any oven function

Symbol	Function	What to use it for
	Quickstar	It is recommended that the oven is always pre-heated before use, whatever the cooking temperature. Quick start is not suitable for cooking - once the oven has reached temperature, switch to one of the oven functions below.
	Defrost	Place small frozen items on an oven tray at the lowest shelf position, and set the temperature selector knob to 0°C. Never use heat to defrost as this can pose a health risk. Larger items such as joints, or a whole chicken or turkey, should be defrosted in the refrigerator.
	Conventional oven	Ideal for roasting and for baking items such as bread or rich fruit cakes on a single shelf.
	Lower element	Use at low temperatures for slow-cooking casseroles, custard or for warming plates. Use at high temperatures for cooking sweet and savoury pastry tarts.
	Upper element	Use for browning and reheating dishes such as lasagne, moussaka and cauliflower cheese.
	Conventional grill	Ideal for crumpets, muffins and Welsh rarebit. Use when grilling for less than 15mins. For foods needing a longer time use fan assisted grilling.
	Fan assisted grill	The fan circulates hot air around the food helping to cook it all the way through. Ideal for cooking meat such as sausages and chicken portions. Cooking high water content foods such as bacon and chops with this function helps to reduce condensation. (Recommended: Door closed 200°C, 2nd from top shelf, turn the food over halfway through.
	Fan assisted oven	The fan circulates the hot air around the oven for uniform cooking of larger quantities of food. Use for roasting vegetables, meat and poultry, or baked fish. This function is the best one for cooking frozen potato products and breaded/battered chicken or fish.

	True fan oven	This function is suitable for most recipes and is an efficient way to cook. The temperature is kept uniform throughout the oven and is particularly suitable for baking on several shelves or for batch cooking.
	Pizza	Use for cooking pizza, pastry or flat breads to get a perfectly cooked base.

### Using the grill

The grill pan consists of a wire trivet and enamel tray. Place food on the wire trivet. A lower shelf position can be used to slow cooking down, or the temperature can be reduced. A detachable grill pan handle is supplied for removing the hot tray.

Both the Fan Assisted Grill and Conventional Grill functions are designed to be used with the oven door closed. This ensures efficient preheating and even cooking.

When grilling, always pre-heat the grill element for 5 minutes before introducing food (200°C is recommended for preheating). It is recommended that the grill pan is always removed from the oven when not in use, as air flow around the oven can be impaired. The grill should be used with the oven door closed. Use the Fan Assisted Grill function for thicker pieces of meat and when cooking high water content foods to reduce condensation.

Always use oven gloves when handling the grill pan and turning food. Do not line the grill pan with aluminium foil, this can cause damage to the enamel coating and the grill elements.

At the end of cooking remove the grill pan for cleaning. If high fat content foods have been prepared, leave the grill turned on at a maximum temperature for 5 minutes to clean the grill element.

## USING THE NATURAL CONVENTIONAL ELECTRIC OVEN

When using the oven for the first time it should be operated for a maximum of 30 minutes at a temperature of about 250° to eliminate any odours generated by the internal insulation. During normal oven use, select the desired cooking temperature using the thermostat knob and wait until the orange light turns off before putting in any food. The oven is equipped with 5 guides at different heights (fig.44) which can be used to insert shelves or the tray. To keep the oven as clean as possible it is recommended to cook meat on the tray or on the shelf that has been inserted inside the tray. Table No. 8 below lists the cooking times and the position of the tray for different types of foods. Personal experience will help to determine any variations in the values reported in the table. In any case, it is recommended to follow the instructions of the specific recipe being used.

TABLE N°8

NATURAL CONVENTIONAL ELECTRIC OVEN COOKING TABLE			
	TEMP °C	HEIGHT	MINUTES
<b>MEAT</b>			
PORK ROAST/VEAL ROAST	225	4/5	60-80
BEEF ROAST (YOUNG STEER)	225	4/5	60-80
BEEF ROAST/ROAST TURKEY	250	4/5	50-60
LAMB ROAST	225	4/5	40-50
ROAST BEEF	230	4	50-60
ROAST HARE	250	4/5	40-50
ROAST RABBIT	250	4/5	60-80
ROAST GOOSE	225	4	60-70
ROAST DUCK	250	4	45-60
ROAST CHICKEN	250	4/5	40-45
<b>FISH</b>			
	200-225	3	15-25
<b>PASTRY</b>			
FRUIT PIE	225	3	35-40
TEA CAKE	175-200	3	50-55
BRIOCHES	175-200	3	25-30
SPONGE CAKE	220-250	3	20-30
RING CAKE	180-200	3	30-40
SWEET PUFF PASTRIES/APPLE FRITTERS	200-220	3	15-20
RAISIN LOAF	250	3	25-35
STRUDEL	180	3	20-30
SAVOIA COOKIES	180-200	3	40-50
SAZOIARDI SANDWICH	200-220	3	20-30
TOAST SANDWICH	250	2	5
BREAD	220	4	30
PIZZA	220	4	20

## USING THE VENTILATED ELECTRIC OVEN

When using the oven for the first time it should be operated for a maximum of 30 minutes at a temperature of about 250° to eliminate any odours generated by the internal insulation.

Before cooking, allow the oven to reach the desired temperature setting waiting for the orange light to turn off. This type of oven is equipped with a circular element around which a fan has been installed that creates forced-air circulation in the horizontal direction. Thanks to this type of operation, the ventilated oven can be used for different types of cooking at the same time, without changing the taste of each food. Only some models are equipped with a removable metallic filter applied to the rear screen which collects the fat while a roast is cooking. Therefore, it is recommended to remove this fat periodically, washing the

screen with soapy water and rinsing thoroughly. To remove the metallic filter just apply slight pressure toward the top on the tab indicated by the arrow. Hot-air circulation guarantees a uniform distribution of heat. Pre-heating the oven is not necessary, but for very delicate pastries, it is recommended to heat the oven before inserting the trays.

The ventilated conventional system partially changes the various notions about traditional cooking. Meat no longer needs to be turned while it is cooking and the rotisserie is no longer needed to cook a roast on the spit. Just put the meat directly on the shelf.

TABLE N°9

VENTILATED ELECTRIC OVEN COOKING TABLE			
	TEMP °C	HEIGHT	MINUTES
<b>MEAT</b>			
PORK ROAST	160-170	3	70-100
BEEF ROAST (YOUNG STEER)	170-180	3	65-90
BEEF ROAST	170-190	3	40-60
VEAL ROAST	160-180	3	65-90
LAMB ROAST	140-160	3	100-130
ROAST BEEF	180-190	3	40-45
ROAST HARE	170-180	3	30-40
ROAST RABBIT	160-170	3	80-100
ROAST TURKEY	160-170	3	160-240
ROAST GOOSE	160-180	3	120-160
ROAST DUCK	170-180	3	100-160
ROAST CHICKEN	180	3	70-90
<b>FISH</b>			
	160-180	2/3	
<b>PASTRY</b>			
FRUIT PIE	180-200	3	40-50
TEA CAKE	200-220	3	40-45
BRIOCHES	170-180	3	40-60
SPONGE CAKE	200-230	3	25-35
RING CAKE	160-180	3	35-45
SWEET PUFF PASTRIES	180-200	3	20-30
RAISIN LOAF	230-250	3	30-40
STRUDEL	160	3	25-35
SAVOIA COOKIES	150-180	3	50-60
APPLE FRITTERS	180-200	3	18-25
SAZOIARDI SANDWICH	170-180	3	30-40
TOAST SANDWICH	230-250	2	7
BREAD	200-220	2	40
PIZZA	200-220	3	20

### USING THE GAS GRILL

The gas grill can be combined only with the gas oven. It is controlled with the same gas oven knob, but turning it clockwise instead of counterclockwise (see the gas oven use instructions), matching the symbol with the indicator. The grill burner always operates at maximum and therefore there is no minimum position. In addition, it is equipped with a safety device to prevent the flame from going out. The gas grill can also be ignited in different ways:

- **Manual lighting:** Just completely open the oven door, turn the knob so that the relative symbol matches the indicator, while pressing the knob, and, at the same time, put a lit match next to the burner. Make sure that the burner is completely lit and after about 10 seconds release the knob. Make sure that the burner remains on, otherwise repeat the operation.

- **Electric ignition:** In this case, completely open the oven door, press and turn the knob so that the relative symbol matches the indicator, then press the thermostat knob (models with ignition trough knob). Wait about 10 seconds after the burner has been completely lit and then release the knob. Make sure that the burner remains on, otherwise repeat the operation. As for cookers without ignition trough knob, press the thermostat knob and the key with the spark symbol, wait about 10 seconds after the burner has been completely lit and then release the knob. Make sure that the burner remains on, otherwise repeat the operation.

**WARNING: As with the oven, the grill must be lit with the door completely open.**

The gas grill can be used to grill foods on the oven shelf or using the rotisserie.

**Grilling on the shelf:** In this case, the shelf supplied is placed on level 4 or 5 and the foods to be grilled are placed on top, while the tray is inserted on the lower levels to collect the cooking juices.

Then light the grill burner according to the instructions described above.

**IMPORTANT: grill foods on the shelf always with the door close.**

**WARNING: the accessible parts may become very hot while grilling. Keep children away from the appliance while cooking.**

**Grilling with the rotisserie:** This is used to grill with the rotating skewer. Therefore, insert the skewer holder on the side shelves at level 3. Insert the food on the skewer and insert everything into the oven, inserting the point of the skewer into the spindle that projects out from the rear of the oven and resting the front of the skewer into the skewer holder support (fig.50). After, insert the tray into one of the lower guides, then light the grill burner according to the instructions described above and press the button that starts the rotisserie

**IMPORTANT: grill foods with the rotisserie always with the door close.**

**WARNING: the accessible parts may become very hot while grilling. Keep children away from the appliance while cooking.**

## USING THE CONVENTIONAL ELECTRIC GRILL

The electric grill can be linked to the gas oven or to the electric oven.

Both cases, the grill is operated by the thermostat knob of the oven (see also the working of gas or electric oven). The gas grill as well as the electric one can be used to grill on the oven grill or with the rotisserie.

The power of the electric grill is 2500W.

**Grilling on the shelf:** In this case, the shelf supplied is placed on level 4 or 5 and the foods to be grilled are placed on top, while the tray is inserted on the lower levels to collect the cooking juices. Then turn on the grill element switching the thermostat to the relative position (electric oven version).

**Grilling with the rotisserie:** This is used to grill with the rotating skewer. Therefore, insert the skewer holder on the side shelves at level 3. Insert the food on the skewer and insert everything into the oven, inserting the point of the skewer into the spindle that projects out from the rear of the oven and resting the front of the skewer into the skewer holder support. Then, insert the tray into one of the lower guides and switch the thermostat to the relative position and press the button with the rotisserie symbol (electric oven version).

**WARNING: the accessible parts may become very hot while grilling. Keep children away from the appliance while cooking.**

## USING THE VENTILATED ELECTRIC GRILL

The ventilated electric grill is a special function equipped only on the multifunction oven. Set the 9 + 0 switch to the relative position to activate the grill element (3000W) and the electric fan. Generally, to ensure excellent grilling, place the oven shelf in the middle position while the oven tray should be inserted at the bottom.

**IMPORTANT: When using the ventilated electric grill, set the thermostat knob no higher than 175 °C, which is between the 150 °C and 200 °C setting, to avoid overheating the front of the appliance. In fact, ventilated grilling must be carried out with the door closed.**

### Note:

The cooker is equipped with the cooling fan that starts operation each time the oven knob is on a position different from 0 (zero). The fan circulates the air between the control panel and the oven door and also allows the control panel and the oven door stay at a warm temperature during the appliance operation in any condition.

## USING THE MINUTE-MINDER

The minute-minder advises the user, with an acoustic signal, when food has been cooked, after a certain time period has elapsed. To use the device, wind the minute-minder by turning the knob clockwise one complete turn. Then turn the knob counterclockwise so that the indicator corresponds with the selected cooking time (fig.51).

**WARNING: the acoustic signal does not stop the cooking cycle. The use must turn off the cooking cycle by hand using the relative knobs.**

## USING THE END OF COOKING TIMER (Fig.52)

It allows to select the cooking time manually or timer with automatic shut off of the oven at the end of cooking.

If not cooking time is selected, it is necessary to position the timer knob on the symbol .

To turn off the oven, select the timer knob on the desired cooking time and set the function and the temperature knobs; the end of the countdown will be confirmed with a repeating tone.

NOTE: This function is available for the electric oven only.

## USING THE DIGITAL CLOCK (Fig.53)

### Power on

Display is flashing

### Time of day function

3 button version: press time of day button

2 button version: press both button simultaneous

Set time of day with "+" and "-" buttons.

This function remains activated 7 seconds after the last "+" / "-" operation!

### Change Summertime / Wintertime

Activate time of day function; press the button for 4 seconds until the hours display will flash.

Change the hours only by using the "+" or "-" button. The minutes and hidden seconds will not be affected !

### Set timer

This function will be activated with "+" button. Press "+" button again to increase duration time.

During setting the units are 10 seconds steps or minutes.

During count down the timer has priority in the display. The bell- symbol illuminated. The units are seconds or minutes in the long time section.

The maximum time is 10 h. The format change will happen after 99 minutes and 50 seconds to 1 hour and 40 minutes.

The pot- symbol illuminated.

To show time of day press "time of day" button for 6 seconds.

### Reset timer

Count down to zero with permanent pressing " – " button. (automatic stop at zero )

### Signal



The signal after "time out" will stay 7 minutes if it has not been reset with "time of day" button.  
The following signal will be skipped if time of day is pressed during the last 15 seconds of the timer.

#### Signal frequency

If no function is activated, the signal frequency can be selected by pressing the "-" button.  
Three different frequencies (1,5 ; 2,0 ; 3,0kHz) are selectable.

### **USING THE TOUCH CLOCK (Fig.54)**

#### **Mains frequency detection**

At power on mains frequency is determined. When the timer is connected to 60Hz, the Celsius symbol is flashing during start-up.

#### **Power On**

At power on, the relay contact is opened. The display and AUTO symbol flashes and time of day starts from 0:00. Power on state with flashing daytime remains until time of day is set.

#### **Setting Time of Day**

Press PLUS and MINUS button simultaneously. At Power On, also MODE button is possible.

Time of day can be set with PLUS or MINUS, while the colon between hours and minutes is flashing. Quick setting mode starts when PLUS or MINUS is held for more than 1 second. If daytime setting mode is selected while an automatic program is active, the automatic program is cancelled.

#### **The Buzzer**

The buzzer interval alarm signal sounds if minute minder has reached the end time. The signal can be switched off by pressing any key or by passing the signal duration limit.

#### **Changing the Buzzer frequency**

First press Plus and Minus simultaneously (menu far editing the time) and then Mode for selecting the menu far changing the buzzer frequency. While the text is visible the buzzer signal frequency can be changed by touching Minus repetitively.

Note: If the touch pad is inactive, a visual alarm will only be reset when a valid key combination is pressed far more than 2 seconds.

#### **Clearing Programs and Manual function**

The duration of the minute minder can be cleared by

- a) **"clear Function"**: First select minute minder program, then press PLUS and MINUS button simultaneously. after this clear the display returns from adjustment mode to time of day immediately.
- b) Back counting of duration to zero. The timer remains in adjustment mode.

#### **Minute Minder**

While minute minder mode is selected, the Bell symbol flashes and the display reads the remaining time in hours and minutes, only if the last minute is counting down the remaining seconds are displayed. An active minute minder program is indicated by the statically illuminated Bell symbol. If alarm time has finished, an acoustic interval signal sounds and the Bell symbol flashes. The minute minder program runs independently of other programs.

#### **Key Lock**

After power on reset or when no key is pressed for 7 seconds, the key lock function is activated. Pressing a valid key or key combination for 2 seconds or more will deactivate the key lock.

### **USING THE ANALOG CLOCK (Fig.55)**

For setting up the time displayed by watch pointers push briefly twice the knob till getting the CLOCK icon flashing.

For increasing or decreasing time displayed 1 minute by 1, turn the knob clockwise or counterclockwise, le minutes pointer will increase or decrease 1 minute by minute clockwise or counterclockwise.10 seconds after last set up the electronic timer will exit time set up mode. Minute minder set up will activate a simple alarm when set up time is over.

For setting up an alarm push briefly once the knob till getting ALARM icon flashing. The turn the knob, set up the alarm time and briefly push once the knob to confirm; ALARM icon will stay on for all the set up time. When set up time is over an acoustic buzz will be activated. Push again briefly once the knob for going back to time display.

For cancelling minute minder set up keep the knob pushed until ALARM icon goes off.

### **ELECTRONIC TIMER PROGRAMMER (Fig. 56)**

#### **Setting**

Select a function by pressing the function button and set the required time with the +/- buttons.

#### **+/- buttons**

Pressing the "+" button increases the time set, pressing "-" decreases it. The count-up and countdown speed increases the longer the button is held in the appropriate position

#### **Setting the time of day**

Select the time of day function by pressing the duration and end time button together and set the time of day with the +/- buttons.

Any programme which has been set is cancelled and the outputs switched on

#### **Manual operation**

Press duration and end time button together. The relay contacts will switch on. The "A" symbol will be erased, the pot symbol illuminated. Any programme which has been set is cancelled.

#### **Semi-automatic operation with cooking duration**

Select the cooking duration function and set the required duration with +/- button. "A" and cookpot symbol appear. The relay output becomes active. If time of day = cooking end time the relay output and the cookpot symbol are switched off.

The audible signal sounds. The symbol "A" blinks.

#### **Semi-automatic operation with cooking end time**

Select the cooking end time function and set the required duration with +/- button. "A" and cookpot symbol will appear. The relay output becomes active. If time of day = cooking end time the relay output and the cookpot symbol are switched off. The audible signal sounds and "A" blinks.

**Fully automatic operation**

Select the cooking duration function and set the required duration with +/- button. The "A" symbol appears. The relay is switched on and the cookpot symbol appears. Select the cooking end time function and the earliest possible end time is displayed. Set the required end time with the +/- buttons. The relay and the cookpot symbol are switched off.

The cookpot symbol appears again when time of day = the calculated start time.

After the automatic programme has ended, the symbol "A" blinks.

The audible signal is heard and the cook pot symbol and the relay are switched off.

**Minute minder**

Select the minute minder button and set required time with the +/- buttons. As the time set elapses the bell symbol is displayed. After the time set has elapsed, the audible signal sounds.

**Audible signal**

The audible signal sounds at the end of a minute minder cycle or of a cooking programme for a period of 7 minutes. The signal can be cancelled by pressing any function button. Pressing the "-" button without having previously selected a function the frequency of the signal changes. A selection from 3 possibilities can be made. The selected signal is audible as long as the time the "-" button is pressed.

**Programme start and verification**

A programme which has been set is carried out after setting the time required. The "time to run" can be verified at any time by selecting the appropriate function.

**Setting error identification**

The setting is correct if the time of day is in between the calculated cooking start and end times. If an error has been made, this will be indicated by the audible signal and by the symbol "A" flashing. The faulty setting can be corrected by changing one or both functions.

**Cancelling programme**

A programme can be cancelled by selecting the manual function. After a programme which has been set comes to an end, it is automatically cancelled.

**USING THE 3 KEYS ELECTRONIC PROGRAMMER (Fig.57)**

**The first start up**

The numbers and the A letter on the display are blinking when the oven is switched on for the first time, or after a power cut: the appliance cannot be operated in this condition.



To set the hour and/or to enable the appliance to operate press the M key for at least 2 seconds: the A letter turns off and the numbers now are steady on the display.

The dot (3) starts blinking: press the - or + key to set the hour.

The hour is accepted by the programmer just few second after having released the key.

N.B. the appliance can be correctly used for coking only when you will see on the display the symbol (2).

**The symbols on the display:**

1	A*	Automatic programmer is working. (* in some models there is the writing 'Auto' instead of A).
2		The appliance is ready for manual use (not automatic).
3	.	When blinking, the programmer is in setting hour mode.
4		Timer set.
5	-	Decreasing numbers when setting the timer. Also for choose your desired sound level ( 3 levels available).
6	M	"Mode" kev to access the programming options of the programme.
7	+	Increasing numbers when setting the timer.

**Timer**

The purpose of the timer is just of a sound signal, which can be set for a max time of 23h59min. once elapsed the set time, the (4) symbol turns off and a sound signal is heard; this sound set off automatically in 7min, or you can stop it by pressing any key of the programmer. To set the timer press the M key for 2 seconds, or anyway just to see the (4) symbol blinking. Set the timer by using the + or - keys. Release the + or - key when you have matched your desired time. In a few seconds the current time appears on the display together with the ) symbol. The countdown starts immediately from now on.

**Semi-automatic cooking**

Cooking time: Once having selected a coking function and set the desired temperature, press the M key for a 2 seconds time to access the programming mode. The (4) symbol appears. Release and press again the M key. On the display, the A symbol starts blinking and the " dur " writing appears on the display, then it changes to O' 00. Set the cooking time with the - or + keys. (max available time: 10h). The selected time is automatically processed by the programmer in a few seconds, or you can also touch the M key many times just to see again the current time.

The A and (2) symbols will be on the display. Once the set cooking time is finished, a sound will be heard and the oven automatically switches off. Please see the following paragraphs about how to disable the sound alarm and restarting the oven.

**End of cooking**

once having selected a cooking function and set the desired temperature, touch the M key to access the

programming mode for at least 2 sec. the ) symbol switches on. Release and touch again the M key. On the display the A symbol starts blinking and the writing "dur" appears. Touch again the M key. On the display the writing "End" appears. The last one changes few seconds after with the symbol 0- 00. Set the end of cooking time with the keys - or +. (maximum available time: 10h00m). The selected time is automatically processed by the programmer in a few seconds, or you can also touch the M key many times just to see again the current time. The cooking immediately starts, while on the programmer display the current time is shown again in a few seconds. The A and (2) symbols will be on the display. Once the set end of cooking time is finished, a sound will be heard and the oven automatically switches off. Please see the following paragraphs about how to disable the sound alarm and restarting the oven.

#### **Automatic cooking**

Set a cooking time following the instructions on the cooking time paragraph, then set the end of cooking time following the instructions on the previous paragraph. (Max available end of cooking time 24h). The oven automatically switches on at a determined time which is the difference between the end of cooking time and the cooking time.

During the waiting time before cooking, which goes from the oven start to the heating, on the display appears the A symbol to show that an automatic program is on and the current time. The oven on is marked by the (2) symbol. Once the set end of cooking time is finished, a sound will be heard and the oven automatically switches off.

Please see the following paragraphs about how to disable the alarm and restarting the oven.

**How to disable the sound alarm:** To disable the sound just touch one of the keys.

#### **Operating again the oven**

Once a semi-automatic or automatic cooking has expired, on the display appear the current time and the blinking A symbol. In this condition, the heating elements and the light bulb of the oven are disabled. To enable again the oven, just touch and keep the M key up to see the symbol (2) on the display and the A symbol disappears.

#### **OTHER FUNCTIONS**

##### **How to delete a cooking time (semi-automatic or Automatic)**

To delete a semi-automatic or automatic cooking program, with the A symbol on, touch together the - and + keys for at least 2 seconds or anyway up to see the (2) and the disabling of A symbol.

##### **How to delete the countdown timer**

To delete the counting of the timer, which symbol is ) t touch the M key for at least 2 seconds or anyway up to see the ) symbol blinking. Touch together the - and + keys.

##### **Checking the function settings**

The set or remaining time of every cooking function of the programmer can be recalled to the display by entering in program mode with the M key. Touch and keep the M key for almost 2 seconds or anyway up to see the (4) symbol. The remaining time appears on the display, or a series of zero numbers if the timer is disabled. Touch again the M key. On the display appears the "dur" writing, then alternately the remaining time or a series of zero number (disable timer).

By touching again the M key, the end of cooking time appears together with the "End" writing.

##### **How to change the current time or the sound level**

With the programmer in standard mode, the (2) symbol is on, touch together the - and + keys for at least 2 seconds or anyway up to see the dot (3) blinking.

**To update the hour on the display:** touch the + or - keys.

**To change the sound level:** touch the M key. On the display appears the writing: Ton.. followed by a number. Select with the - key your favourite sound level.

Note: number 1 is referred to the highest sound level. The available levels are 3.

**Attention:** Power cut causes the loss of any program, even the clock; that means the programmer will have to be set again.

## **USING THE THERMOMETER (Fig.58)**

The cooker is fitted with a device to measure the temperature in the middle of the oven. This lets you check the temperature inside the oven and adjust food cooking temperatures more accurately.

#### **ELECTRIC OVEN**

When you turn on the oven, the orange light comes on to indicate that the heating elements are working: The thermometer dial will start to move towards the set temperature. The orange light will keep coming on and off, indicating that the heating elements are working to maintain the temperature inside the oven. The light may go off for a few minutes before the thermometer has reached the temperature required. This is normal, because operation of the heating elements is regulated so that heat is distributed properly inside the oven. Heat is optimally distributed inside the oven when the thermometer dial has stopped. If the oven temperature drops or goes up, the thermometer dial will follow these variations in the same way. When the oven is turned off, the temperature on the thermometer will slowly drop until it reaches room temperature.

NOTE: The temperatures on the knob are indicative. Follow the thermometer temperature for cooking.

#### **GAS OVEN**

When the oven is turned on, the burner will start working at the maximum and the thermometer dial will start to move towards the set temperature. The flame may die down before the thermometer has reached the temperature required. This is because burner power is reduced so that heat can be evenly distributed inside the oven. Heat is optimally distributed inside the oven when the thermometer dial has stopped. When the oven is turned off, the temperature on the thermometer will slowly drop until it reaches room temperature.

NOTE: The Thermostat Position and Oven Temperature correspondence in table no. 5 is indicative and depends on various factors such as the type of gas and supply pressure. Follow the thermometer temperature for cooking.

NOTE: it is normal to record different temperatures from those indicated on the panel thermometer, when you measure the temperature in the middle of the oven using a different thermometer. The temperature indicated by the thermometer is the mean temperature inside the oven and does not indicate the temperature of any single point.

## USING THE SELF-CLEANING OVEN

On models which have this device, the self-cleaning oven differs from normal ovens because the inner surfaces are coated with a special micro-porous enamel that absorbs and eliminates grease residues during cooking. If liquid grease is released, self-cleaning is not sufficient, so wipe the grease stains with a damp sponge and then heat the oven to the maximum temperature, wait for it to cool down and wipe again with a damp sponge.

## CLEANING THE APPLIANCE

**Before cleaning the appliance, it should be disconnected from the power supply and turn off the main gas feeder valve.**

### **Cleaning the work surface:**

Periodically clean the burner heads, the enamelled steel grids, the enamelled covers and the flame caps using warm soapy water. Then those parts should be rinsed and thoroughly dried.

**Any liquid that overflows from pots must always be removed using a rag.**

**If it becomes difficult to open or close a valve, do not force it, but immediately request the assistance of the technical service personnel.**

### **Cleaning the enamelled parts:**

To maintain the original features of the enamelled parts they should be cleaned frequently with soapy water. Never use abrasive powders. Do not leave acidic or alkaline substances on the enamelled parts (vinegar, lemon juice, salt, tomato sauce, etc.) and do not wash the enamelled parts while they are still hot.

### **Cleaning the STAINLESS steel parts:**

Clean the parts with soapy water and then dry them with a soft cloth. The shine is maintained by periodically using special products that generally are found in the market. Never use abrasive powders.

### **Cleaning the burner flame caps:**

Since the flame caps are resting on the burner, to clean them just remove them from their seat and wash them with soapy water. After they have been thoroughly dried and having checked that the holes are not clogged, they can be replaced in their proper position.

### **Cleaning the inside of the oven glass:**

Cleaning the interior of the crystals of the oven:

Feature of the oven is the ability to remove the inner glass in order to make the internal cleanliness of crystals. This operation is to be performed in a cold oven and with a damp cloth, taking care not to use abrasive detergents. For the removal of internal glass lock the hinges by inserting the nail that came in the hinges (Fig 59-60) then remove the inner glass as (Fig.61—62-63-64-65-66).

To reassemble the door to perform tasks in the opposite direction as (fig.67-68-69-70).

### **Cleaning the inside of the oven:**

To facilitate intensive cleaning of the oven is practical to dismantle the door by following the instructions listed below. Insert the nail that came in the hinges (Fig. 59-60). Bring the half-open door in place and working with your hands pull the door towards you until the same has not been dropped from the attack. To replace the oven door proceed in reverse order. Also the grids side are easily-removable by unscrewing the rings that secure it to the oven.

## AFTER-SALES TECHNICAL SERVICE AND SPARE PARTS

Before leaving the factory, this appliance was tested and calibrated by skilled and qualified personnel.

Any repairs or calibration that may become necessary after leaving the factory should be performed by skilled personnel. For this reason we advise the customer to contact the Dealer that sold the appliance or the nearest Service Centre, providing them with information about the type of appliance and the type of problem that has occurred. If defective parts must be replaced, it is recommended to replace them with original spare parts that are available only in our technical Service Centres and authorised dealers.

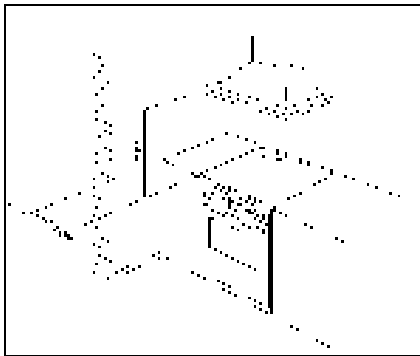

Fig.1

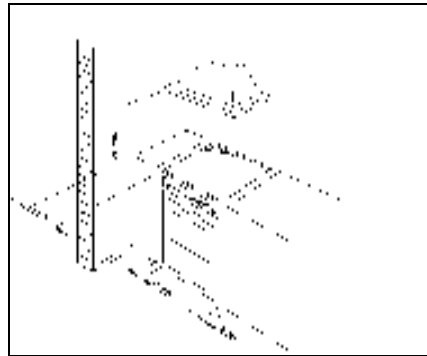

Fig.2

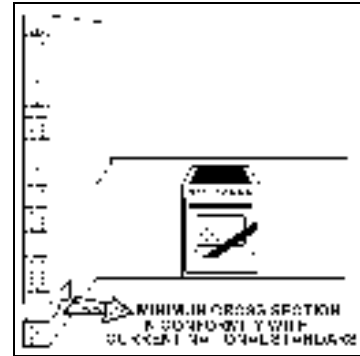

Fig.3

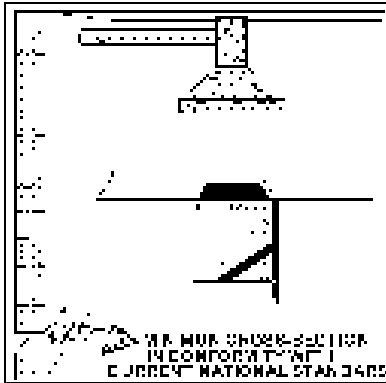

Fig.4

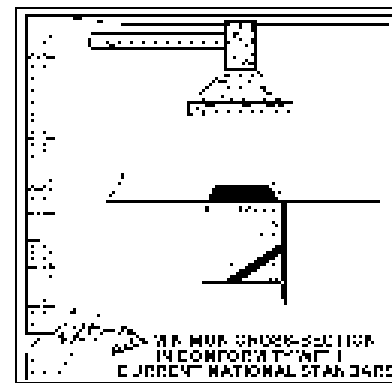

Fig.5

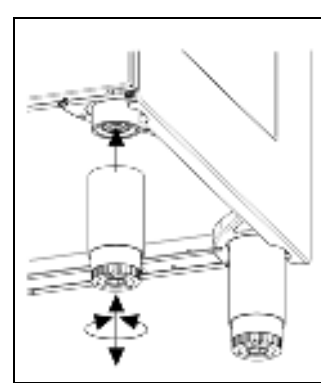

Fig.6

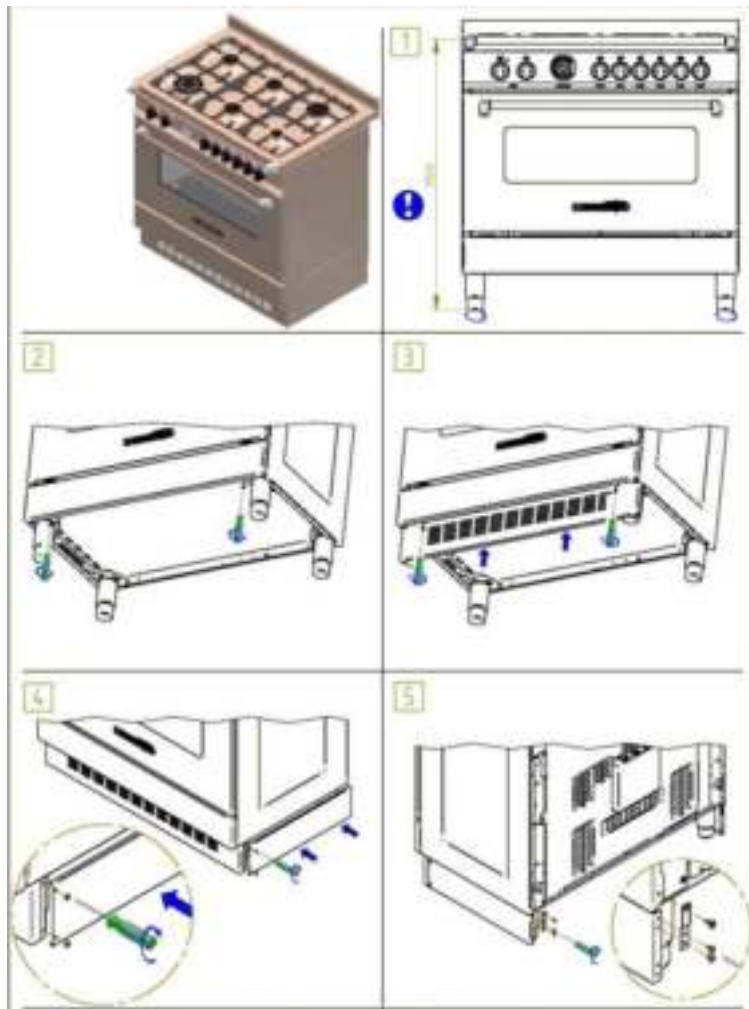

Fig.7

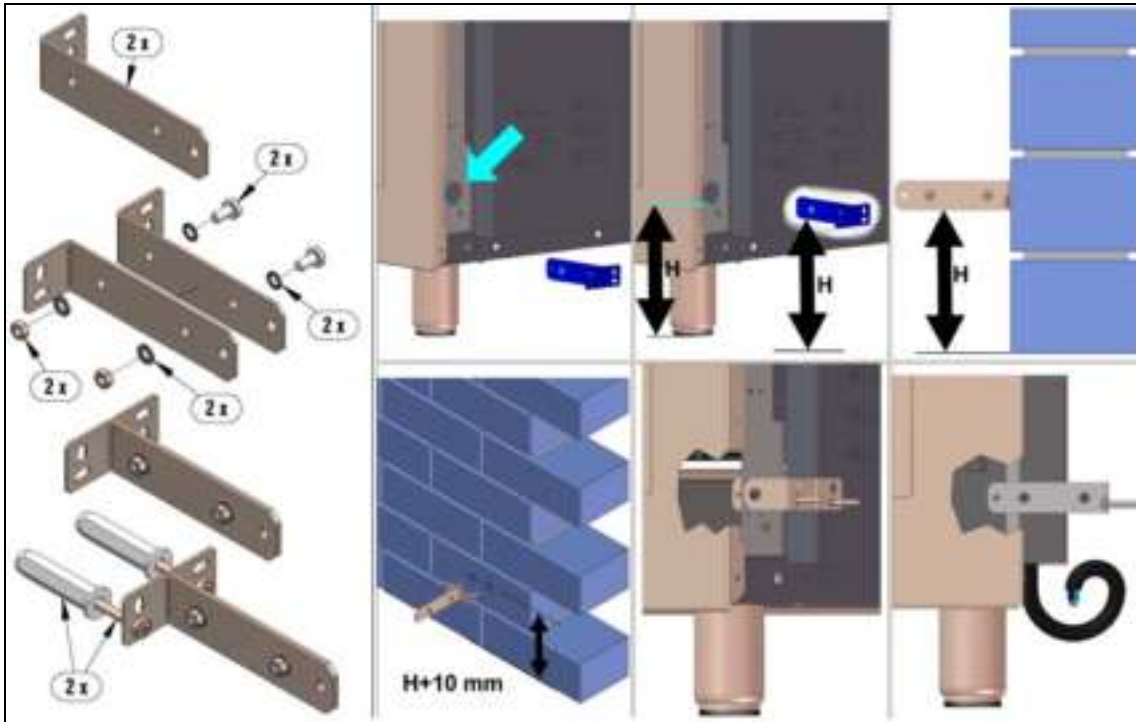

Fig.9

Fig.10

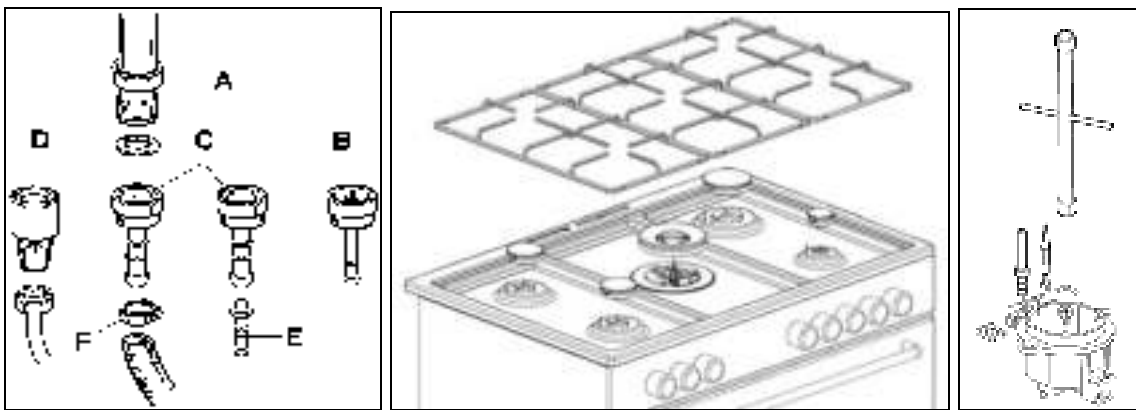

Fig.11

Fig.12

Fig.13



Fig.14



Fig.15

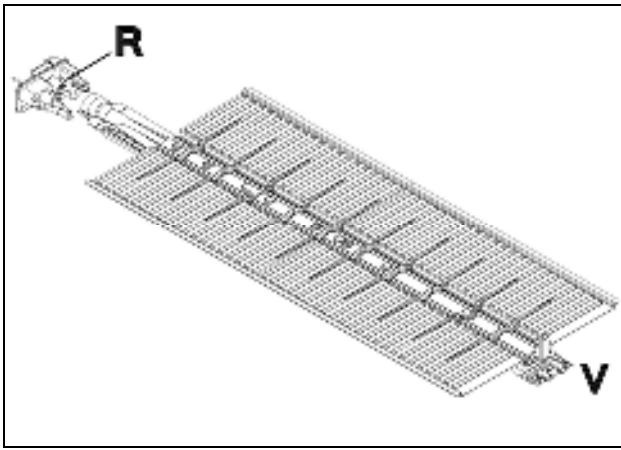

Fig.16

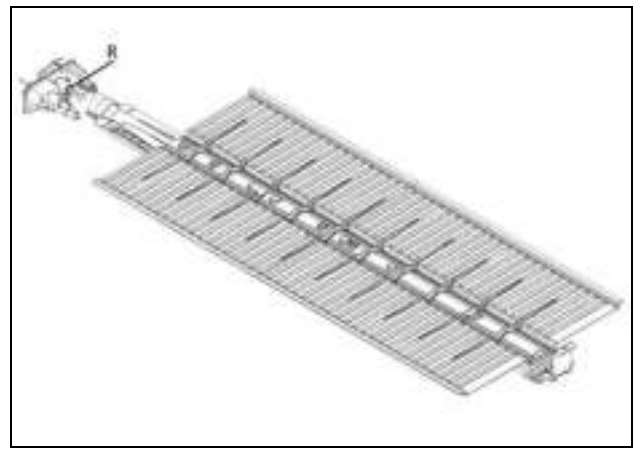

Fig.17

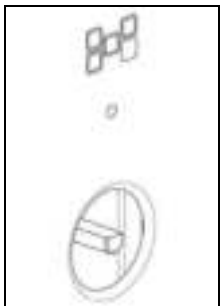

Fig.18

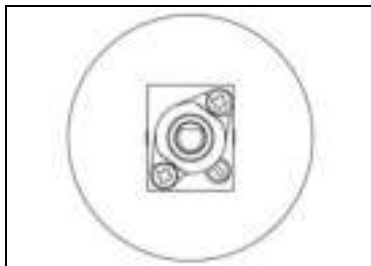

Fig.19



Fig.20

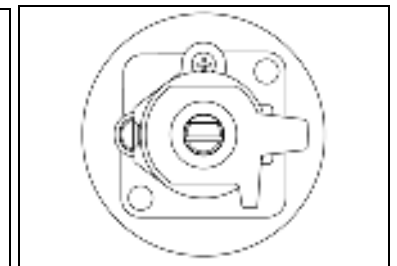

Fig.21

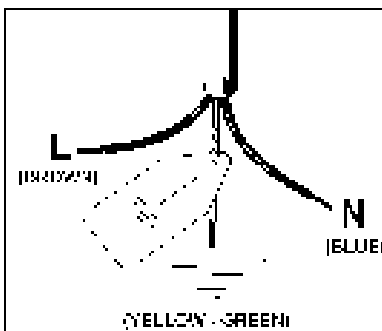

Fig.22

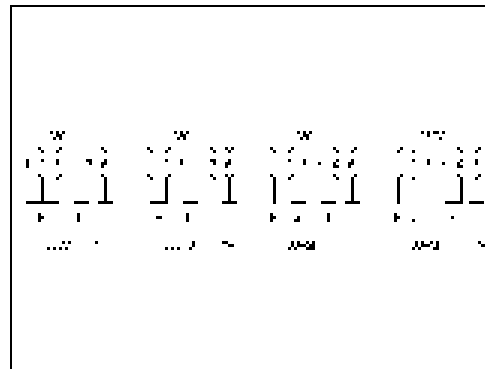

Fig.23

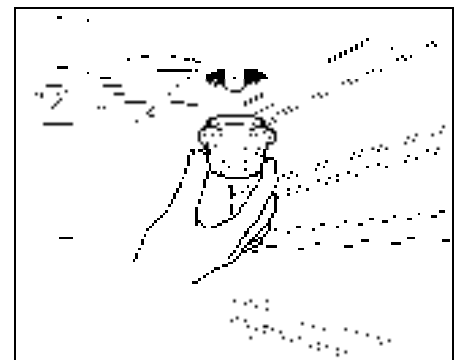

Fig.24

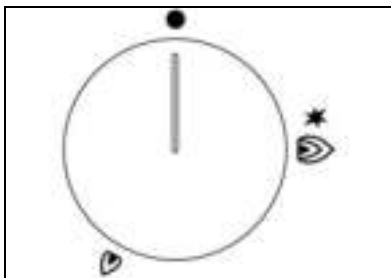

Fig.25

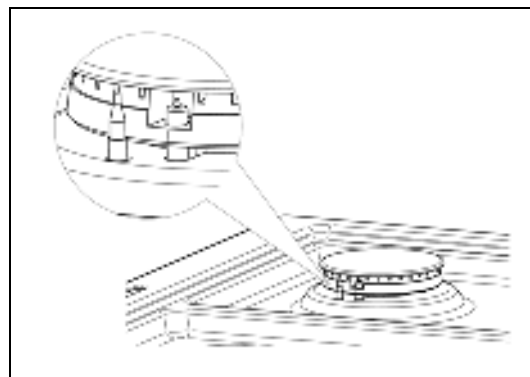

Fig.26

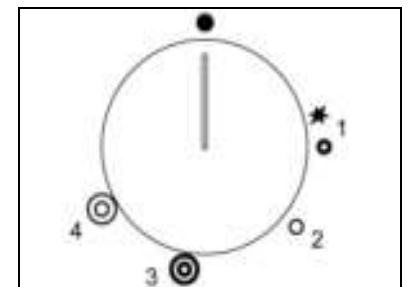

Fig.27

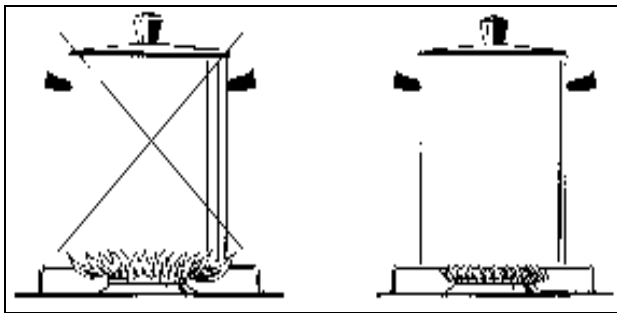

Fig.28

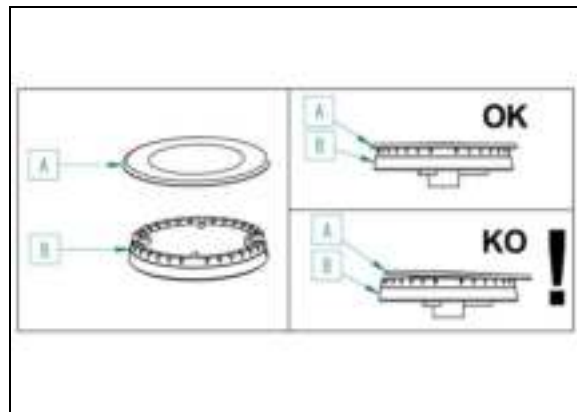

Fig.29

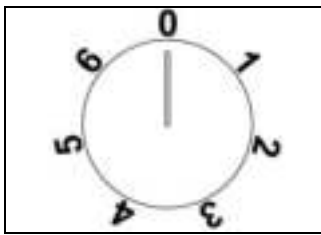

Fig.30

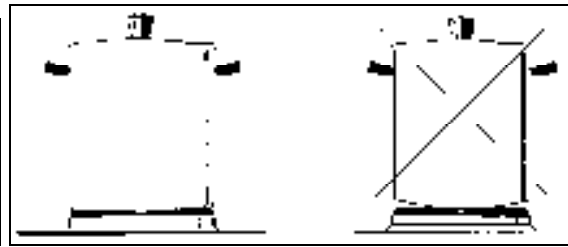

Fig.31

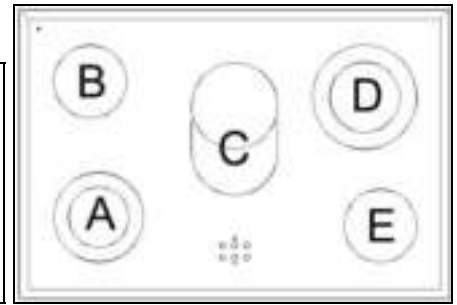

Fig.32

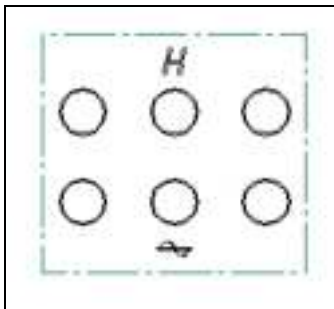

Fig.33

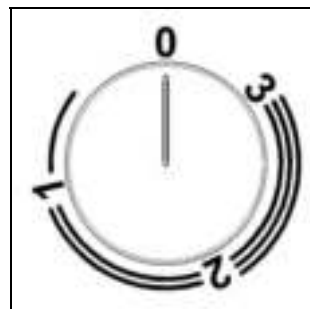

Fig.34

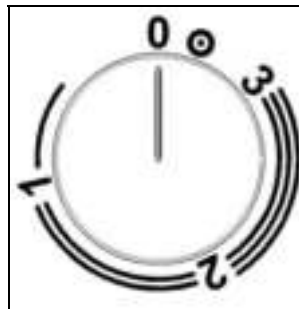

Fig.35

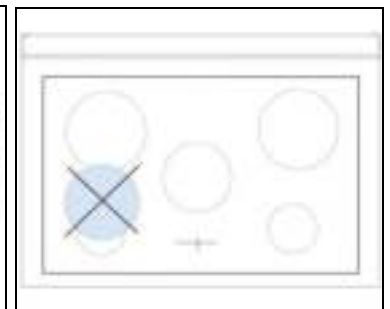

Fig.36

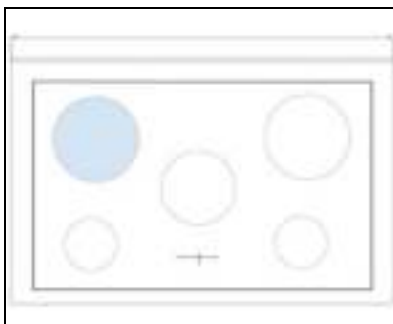

Fig.37

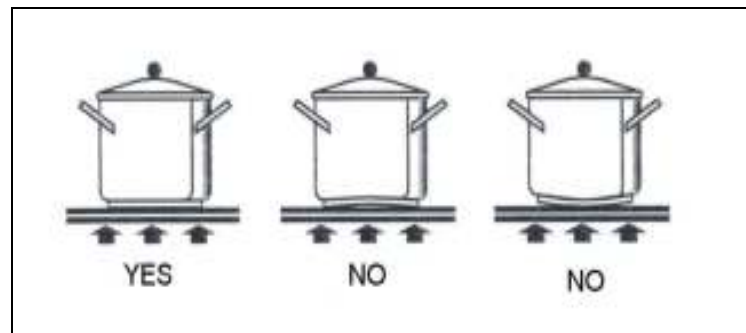

Fig.38

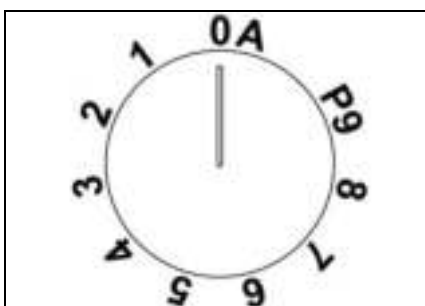

Fig.39

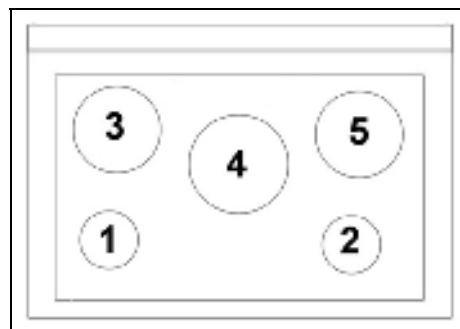

Fig.40



Fig.41



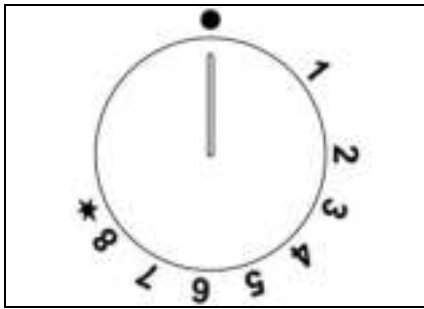

Fig.42

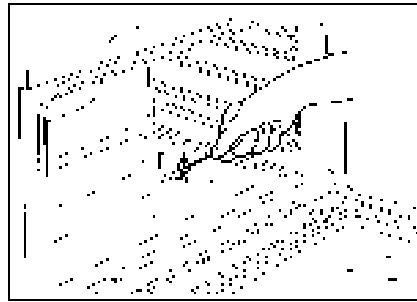

Fig.43

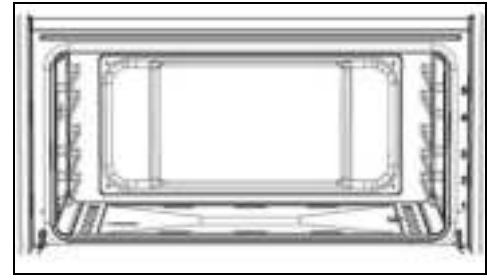

Fig.44

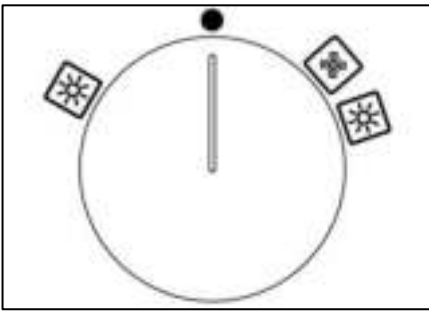

Fig 45

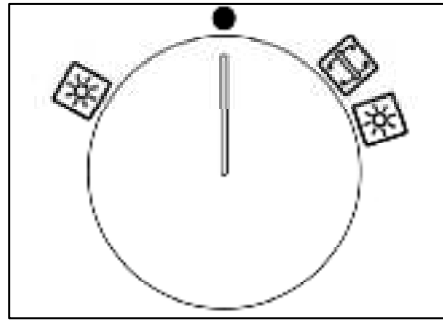

Fig 46

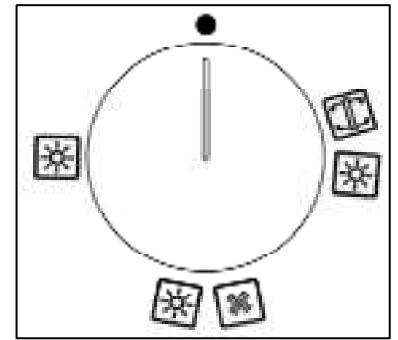

Fig 47

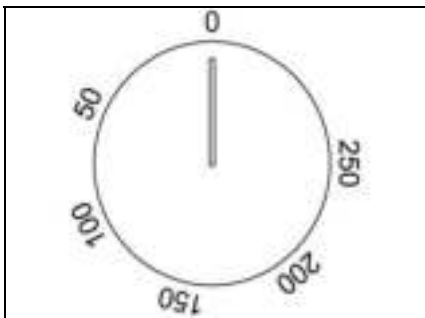

Fig 48

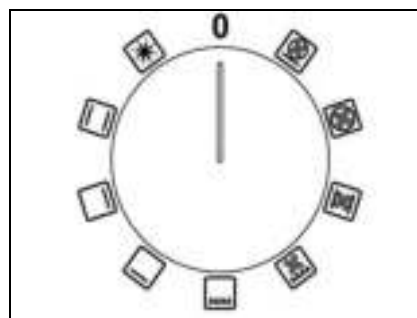

Fig 49

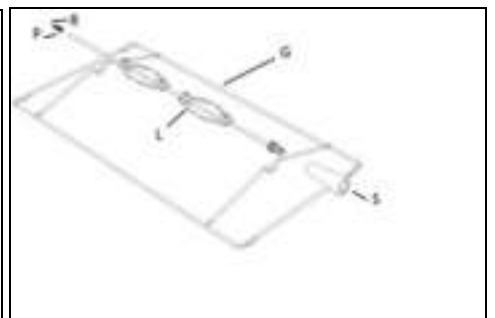

Fig.50

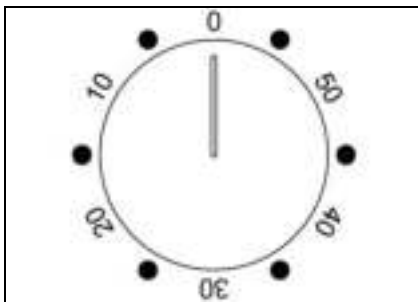

Fig 51

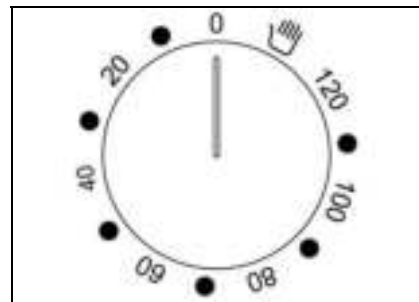

Fig 52

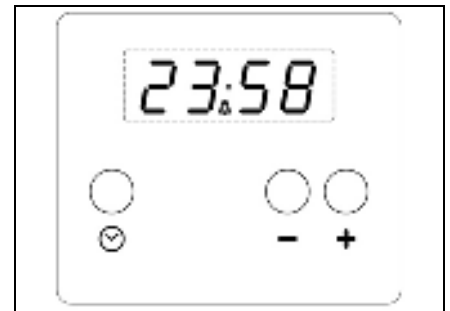

Fig.53



Fig.54

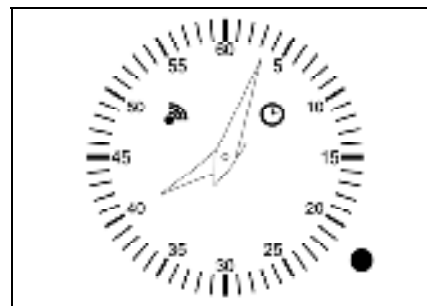

Fig.55



Fig.56



Fig.57

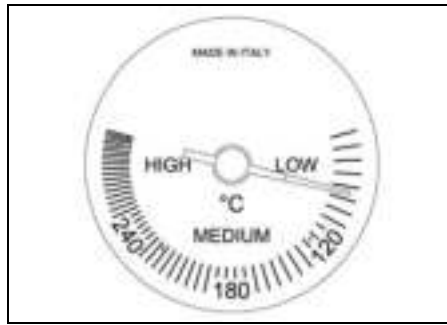

Fig.58

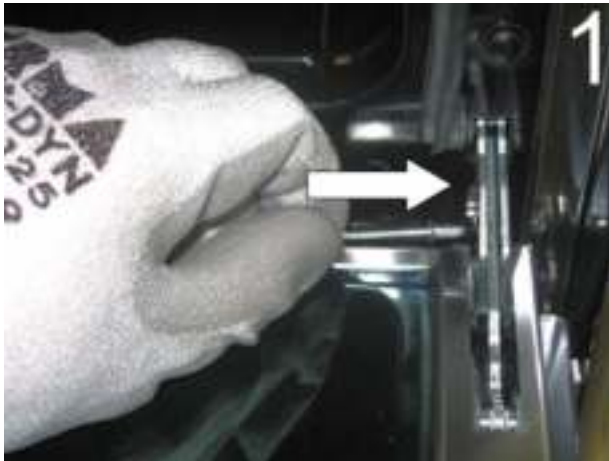

Fig.59



Fig.60



Fig.61



Fig.62



Fig.63



Fig.64



Fig.65



Fig.66



Fig.67

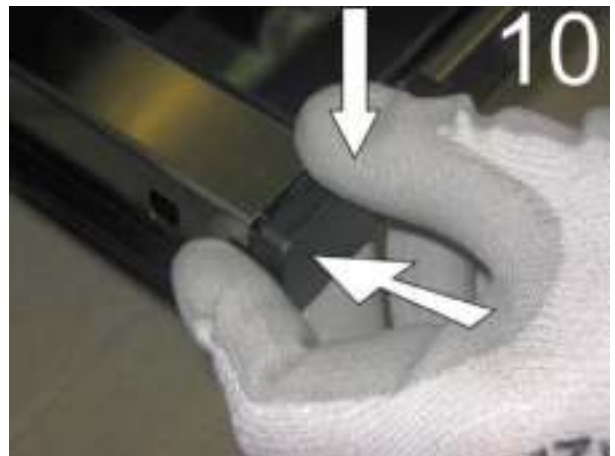

Fig.68



Fig.69

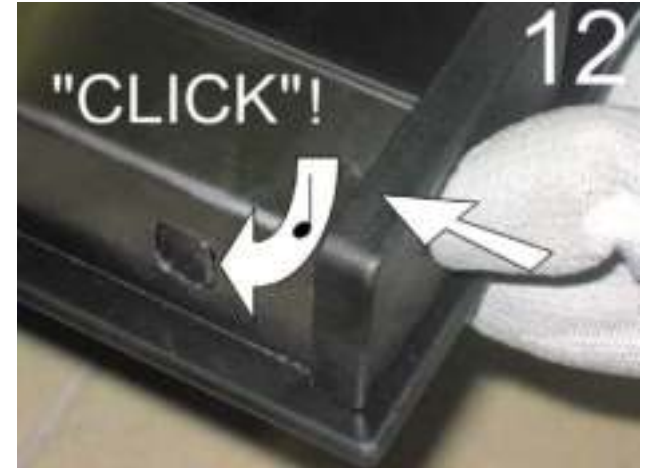

Fig.70

## DEVICE DISPOSAL



Once the appliance has been used up, dispose of it properly at a collection point for electrical appliances. Electrical appliances do not belong in household waste.

Your responsible administration will inform you about the addresses and opening hours of collection points. This is the only way to ensure that old appliances are properly disposed of and recycled. Thank you very much!



Hergestellt in Italien. für / Made in Italy for

**HÄNDLER:**

SARO Gastro-Products GmbH  
Sandbahn 6, 46446 Emmerich am Rhein, Germany  
Tel. +49(0)2822 9258-0  
Fax +49(0)2822 18192  
E-Mail [info@saro.de](mailto:info@saro.de)  
Web: [www.saro.de](http://www.saro.de)

3100132