



SISTEMAS PORTACARGAS
Y ACCESORIOS
ROOF-RACK SYSTEMS
& ACCESSORIES

CRUZBER S.A.
ES-A14018311
P.I. Las Salinas II
ES-14960 Rute
www.cruzber.com



DIN EN 62079:2001
ISO/PAS 11154:2006

Código/Code:

921-001

Lote /Lot: ▶ *ver tabla!*
see table!

Artículo/Item:

Barras de acero
Steel load carriers

Modelo/Model:

OT
30x20x1,2 G

2008-r1



Código de Homologación CEE /
EEC Type Approval Number:

e9*74 / 483*87 / 354*3017*00

Instrucción de montaje

Contenido embalaje

Assembly instructions

Package content

Instruction de montage

Contenu d'emballage

Montageanleitung

Packungsinhalt

Instruções de montagem

Contéudo embalagem

Instrukcja montażu



Zawartość opakowania

Upute za montažu

Sadržaj pakiranja



Szerelési utasítások

Doboz tartalom

<p>Peso producto Products weight</p>  <p>▶ <i>ver tabla!</i> <i>see table!</i></p>		<p>Carga máxima en techo* Maximum roof-load</p>  <p>max. 50 kg</p>
---	--	--

* **Ver información al usuario / See user information!**

Estas barras tienen que usarse con kits de fijación CRUZ!
This load carriers must be used with CRUZ fixation kits!

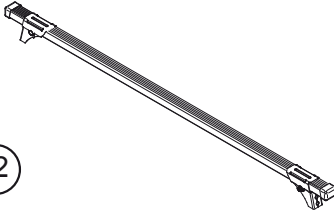
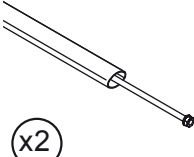
<p>x1</p>  <p>Instrucción montaje Fitting instruction</p>	<p>x1</p>  <p>Información usuario User instructions</p>	<p>x2</p> 
<p>x2</p> 		

Código Code	Modelo barra Bar model	Largo Length	Tensora Tensile bar	 kg	Lote Lot
921-000	OT-105 (823-203)	105 cm	81,5 cm (825-204)	3,64 kg	02/07
921-001	OT-115 (823-213)	115 cm	95 cm (825-214)	3,96 kg	02/07



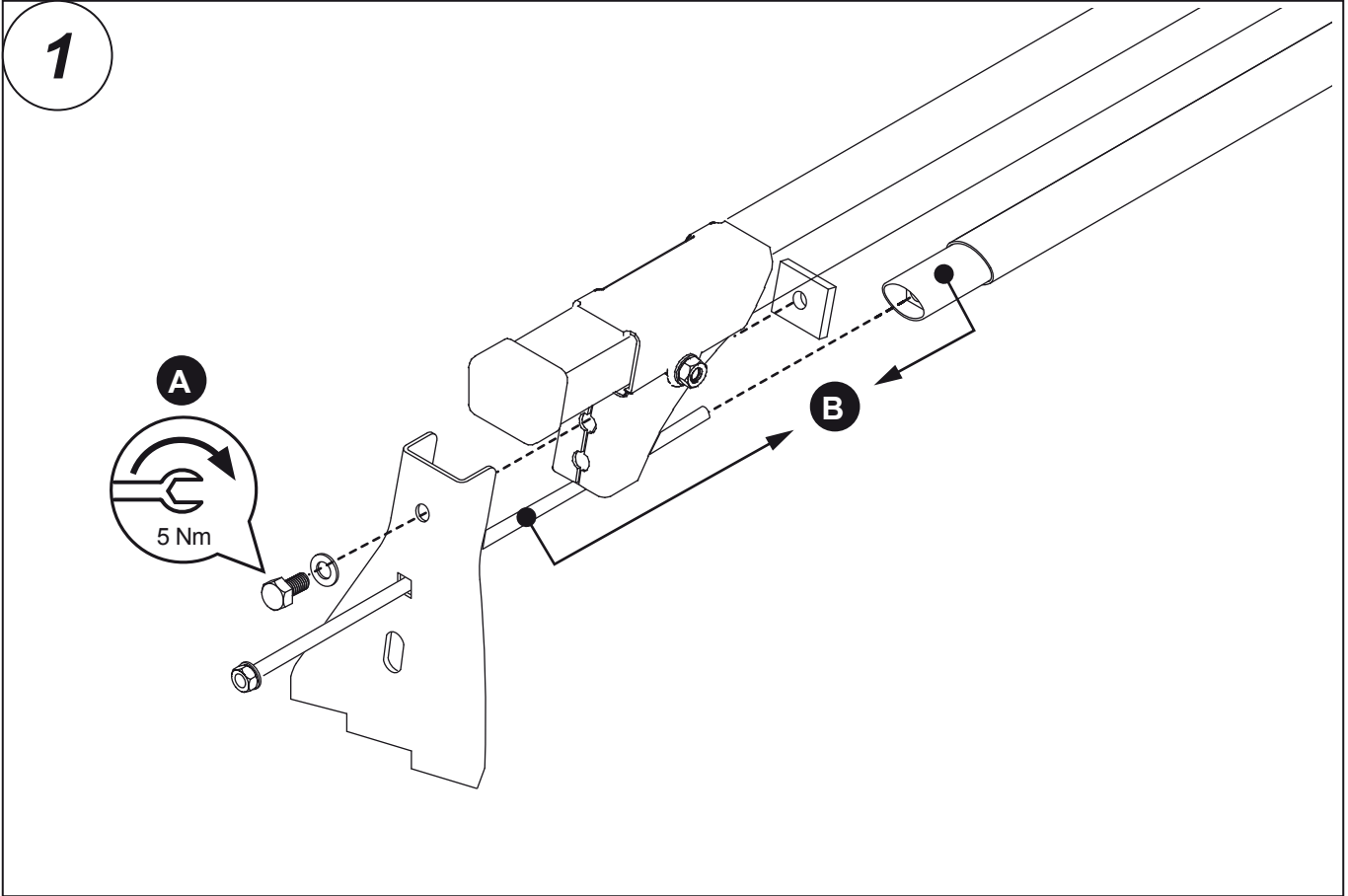

2

► *Siga la instrucción de montaje del kit de fijación.*
 ► *Follow fixation kit instruction.*

