

K'nex®

FOR AGES / ÂGÉS DE / Para Edades

7-14

34043

Dragon Revenge
Roller Coaster Building Set
Vengeance du Dragon
Montagnes Russes Jeu de construction
Venganza del Dragón
Montaña Rusa Juego De Construcción



WARNING:

CHOKING HAZARD – Small parts.
Not for children under 3 years.



ATTENTION :

RISQUE D'ÉTOUFFEMENT – Pièces de petite taille.
Ne convient pas aux enfants de moins de 3 ans.



ADVERTENCIA:

PELIGRO DE ASFIXIA – Piezas pequeñas.
No para niños menores de 3 años.

Keep this important information for future reference

 **WARNING:** CHOKING HAZARD – Small parts. Not for children under 3 years.

WARNING: This product contains a Button or Coin Cell Battery. A swallowed Button or Coin Cell Battery can cause internal chemical burns in as little as two hours and lead to death. Dispose of used batteries immediately. Keep new and used batteries away from children. If you think batteries might have been swallowed or placed inside any part of the body, seek immediate medical attention.

CAUTION: Keep hands, face, hair and clothing away from all moving parts.

CAUTION: Be careful not to tip the model over. Model should be placed on a flat and hard surface.

Do not obstruct track with objects or any part of your body.

Battery Information

How to Insert and Remove Batteries

MOTOR

Insert 2 fresh AA batteries* (LR6) into the compartment with the correct polarity (+/-) as shown here.

* Not included



LIGHT-UP CAR

The light-up car comes with 3 batteries already installed. To replace the batteries, use a small Philips screwdriver to loosen the screws, then remove the battery door. Insert 3 new batteries (LR41, AG3) into the battery compartment with the correct polarity (+/-) as shown here..



CAUTION: To Avoid Battery Leakage

- Insert batteries with correct polarity (+/-) as shown.
- Do not mix different types of batteries.
- Do not mix alkaline, standard (carbon-zinc) or rechargeable batteries.
- Do not mix new and used batteries. Only batteries of the same or equivalent type recommended should be used.
- Remove exhausted batteries from the toy; do not short-circuit supply terminals.
- Remove all batteries if the toy will not be used for a long period of time.

Important Tips

- Alkaline batteries are recommended.
- Rechargeable batteries are not recommended.
- Remove rechargeable batteries before recharging; they must be charged only under adult supervision.
- Non-rechargeable batteries must not be recharged.
- Keep components free of dust; do not immerse or use in water.
- Do not dispose of batteries in a fire; they could leak or explode and cause injury.

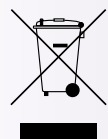

The wheellie bin indicates this product cannot be disposed of with household waste due to presence of hazardous substances.

To protect human health and environment, check your local authority for recycling advice and facilities (2012/19/EU, Europe only).

Gardez précieusement cette notice pour vous y référer ultérieurement

 **ATTENTION :** RISQUE D'ÉTOUFFEMENT – Pièces de petite taille. Ne convient pas aux enfants de moins de 3 ans.

ATTENTION : Ce produit contient une pile bouton ou à pile bouton. Une pile bouton ou une pile bouton avalées peut provoquer des brûlures chimiques internes en à peine deux heures et entraîner la mort. Jeter les piles usagées immédiatement. Gardez les piles neuves et usagées hors de la portée des enfants. Si vous pensez que les piles ont peut-être été avalées ou placées à l'intérieur d'une partie du corps, consultez immédiatement un médecin.

ATTENTION : Gardez les cheveux, les doigts, la figure et les vêtements à l'écart de toutes les pièces mobiles.

ATTENTION : Faire attention de ne pas renverser le modèle. Le modèle devrait être placé sur une surface plate et dure.

Ne pas bloquer les rails avec des objets ou la corps.

Informations sur les Piles

Comment mettre et retirer des piles

MOTEUR

Insérer 2 piles AA (LR6)* neuves dans le compartiment en respectant la polarité (+/-). * Non fournies

VOITURE ILLUMINÉE

La voiture lumineuse est livrée avec 3 piles déjà installées. Pour remplacer les piles, utiliser un petit tournevis Philips pour desserrer la vis, puis retirer la porte de la pile. Insérer 3 nouvelles piles (LR41, AG3) dans le compartiment de batterie avec la polarité correcte (+/-).

ATTENTION : Pour éviter la fuite des piles

- Insérez les piles en respectant la polarité (+/-) comme indiqué.
- Ne pas mélanger différents types de piles.
- Ne pas mélanger des piles alcalines avec des piles standard (carbone-zinc), ou des piles rechargeables.
- Ne pas mélanger des piles neuves avec des piles usées. Il convient d'utiliser uniquement des piles du type recommandé ou d'un type équivalent.
- Retirer toujours les piles faibles ou mortes du produit ; ne pas faire court-circuiter les terminaux.
- Retirez toutes les piles si le jouet ne sera pas utilisé pendant une longue période de temps.

Conseils Importants

- Les piles alcalines sont recommandées.
- Les piles rechargeables ne sont pas recommandées.
- Retirer les piles rechargeables du jouet avant de les recharger; elles doivent être chargées exclusivement en présence d'un adulte.
- Les piles qui ne sont pas rechargeables ne doivent pas être rechargées.
- Veiller à ce que les éléments restent à l'abri de la poussière ; ne pas les plonger ni les utiliser dans l'eau.
- Ne pas jeter les piles dans le feu ; elles risqueraient de fuir ou d'exploser et d'entraîner des blessures.

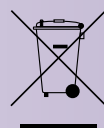

Le symbole "poubelle à roulettes" indique que ce produit ne peut pas être éliminé avec vos déchets ménagers en raison de la présence de substances dangereuses.

Afin de protéger votre santé et l'environnement, renseignez-vous auprès de vos autorités locales afin d'obtenir des conseils sur le recyclage et la localisation des installations adaptées (2012/19/EU, Europe uniquement).

Start Building

Each K'NEX piece has its own shape and color. Try to position your model in the same direction as the instructions. Faded colors show you this section is already built.

Démarre ta Construction

Chaque K'NEX pièce a sa propre forme et sa propre couleur. Pour te faciliter la tâche, oriente le modèle dans le même sens que les instructions. Les pièces ayant une couleur estompée sont celles déjà assemblées.

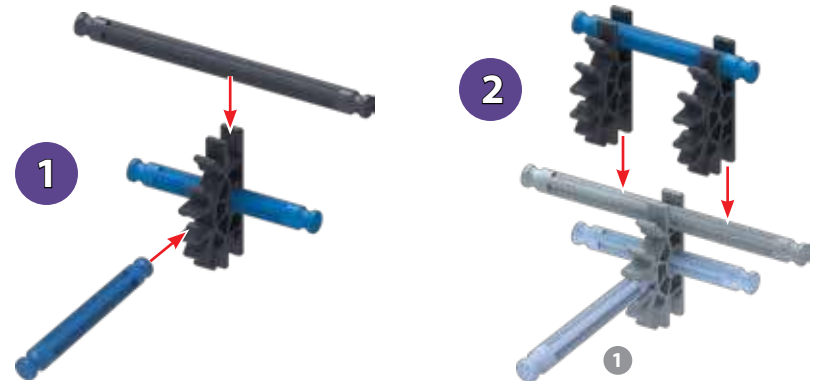

Connectors

Push these special connectors together tightly until you hear a "click".

Connecteurs

Pousse connecteurs spéciaux fort jusqu'à entendre un « clic ».

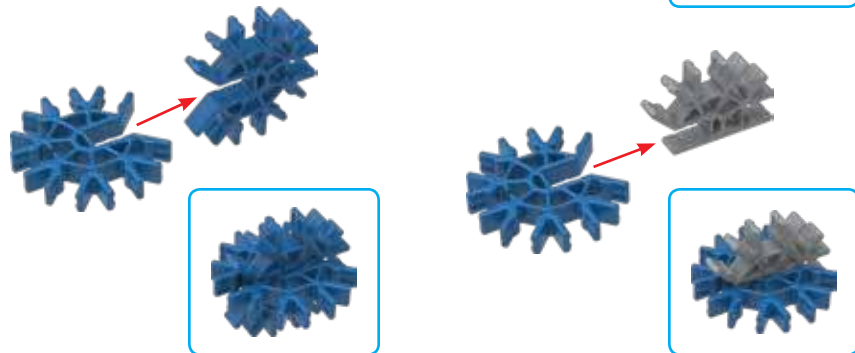
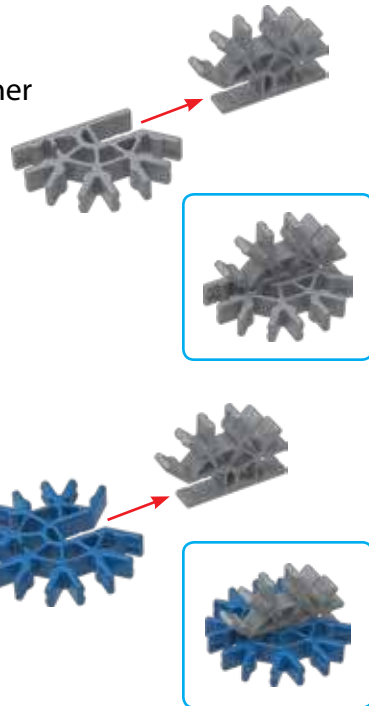

Spacers

Be sure to use the correct color and number of spacers shown.



Séparateurs

Assurez-vous d'utiliser la couleur et le nombre corrects d'entretoises.

Chain

Be sure to attach all the chain links in the same direction.



Chaîne

Assure-toi de fixer tous les maillons de la chaîne dans le même sens.

FCC Statements:

WARNING: Changes or modifications to this unit not expressly approved by the party responsible for the compliance could void the user's right to operate the equipment. This device complies with Part 15 of the FCC rules.

Operation is subject to the following conditions:

1. This device may not cause harmful interference and
 2. This device must accept any interference received, including interference that may cause undesired operation.
- This model is tested to comply with FCC standards- FOR HOME AND OFFICE USE ONLY. This equipment has been tested and found to comply with the limits for a Class B digital device, pursuant to Part 15 of the FCC rules. These limits are designed to provide reasonable protection against harmful interference in a residential installation. This equipment generates, uses and can radiate radio frequency energy, and, if not installed and used in accordance with the instructions, may cause harmful interference to radio communications. However, there is no guarantee that interference will not occur in a particular installation. If this equipment does cause harmful interference to radio or television reception, which can be determined by turning the the equipment off and on, the user is encouraged to try to correct the interference by one or more of following measures: (1) Reorient or redirect the receiving antenna. (2) Increase the separation between the equipment and receiver. (3) Connect the equipment into an outlet on a circuit different from that to which the receiver is connected. (4) Consult the dealer or an experienced radio/TV technician. This Class B digital apparatus complies with Canadian ICES-003.

Déclaration de la FCC :

AVERTISSEMENT : Tout changement ou toute modification non approuvée par le parti responsable de la conformité pourraient annuler le droit de l'utilisateur à faire fonctionner l'appareil. Cet appareil conforme à la Partie 15 de la réglementation de la FCC.

Son fonctionnement est soumis aux deux conditions suivantes:

1. Ce système ne saurait entraîner de brouillage préjudiciable.
2. Ce système doit accepter toute interférence reçue, y compris des interférences susceptibles d'entraîner un fonctionnement indésirable.

Ce modèle est testé afin d'être conforme aux normes FCC – POUR UN USAGE PERSONNEL OU PROFESSIONNEL SEULEMENT. Cet équipement a été testé et est conforme aux limites d'un appareil numérique de classe B, en vertu de la partie 15 de la réglementation de la FCC. Ces limites sont déterminées en vue de fournir une protection raisonnable contre un brouillage préjudiciable dans une installation résidentielle. Cet équipement génère, utilise et est en mesure d'irradier de l'énergie radiofréquence, et s'il n'est pas installé ou utilisé conformément au mode d'emploi, risque d'entraîner un brouillage préjudiciable pour les communications radio. Il n'y a toutefois aucune garantie qu'un brouillage ne surviendra pas pour une installation particulière. Si cet équipement entraîne un brouillage préjudiciable à une réception radio ou de télévision, ce qui peut être déterminé en l'éteignant et en le rallumant, il est recommandé d'essayer de remédier au brouillage en prenant l'une ou plusieurs des mesures suivantes : (1) Réorienter ou changer de place l'antenne, de réception. (2) Augmenter l'écart entre l'équipement et le récepteur. (3) Brancher l'équipement dans une prise sur un circuit qui soit différent de celui nécessaire au récepteur. (4) Consulter le fournisseur ou encore un technicien qualifié en matière de radio/TV. Cet appareil numérique de classe B est conforme aux normes canadiennes NMB-003.

Parts List

Before you start building, be sure to compare the parts in your set with the parts list here. If anything is missing, call or write to us using the information on the back cover. We are here to help you!

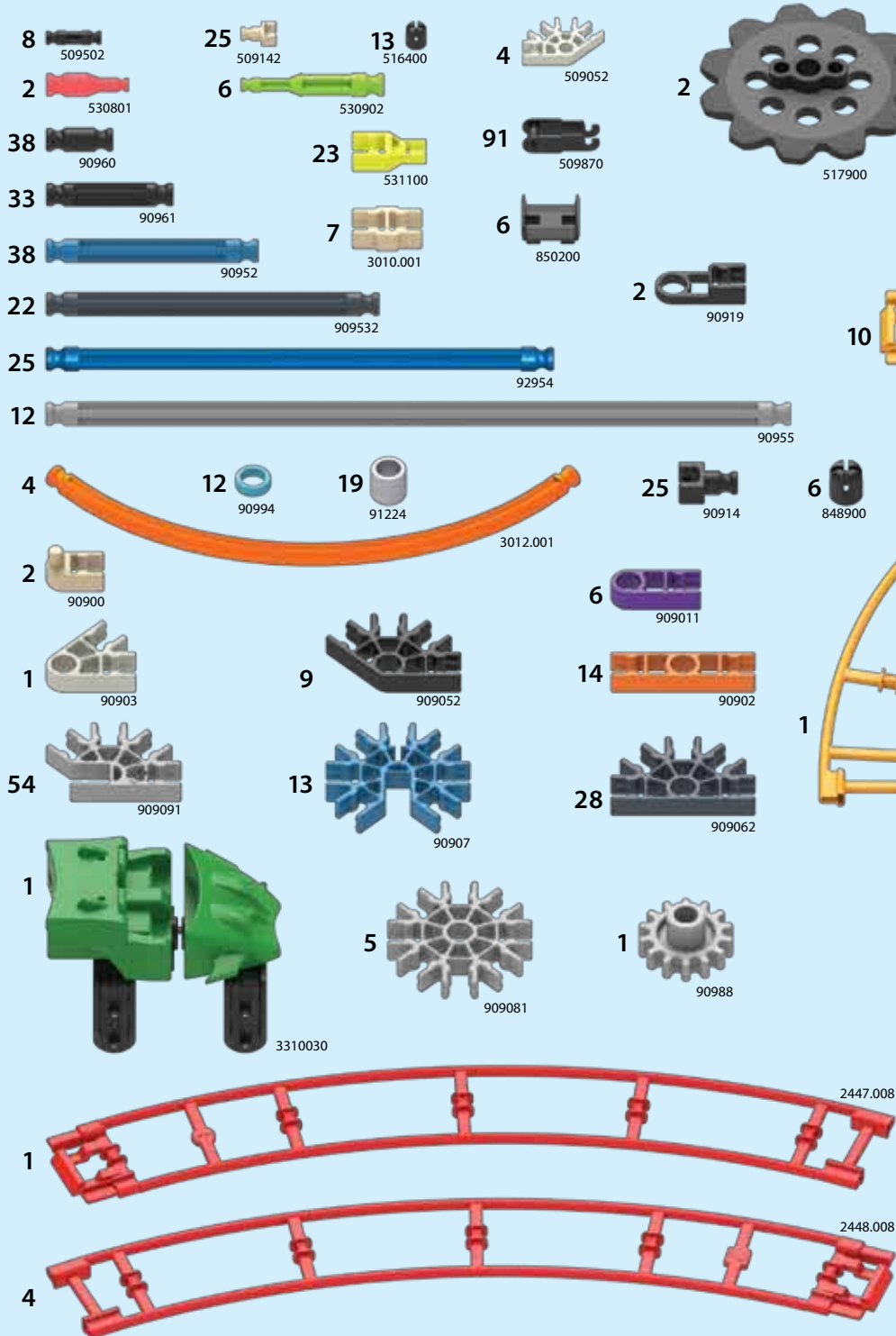

Liste des Pièces

Avant de commencer à construire, assure-toi de comparer les pièces dans ta boîte à la liste de pièces fournie ici. S'il manque quelque chose, téléphone-nous ou écris-nous en te servant des informations figurant au verso de la notice. Nous sommes là pour t'aider !

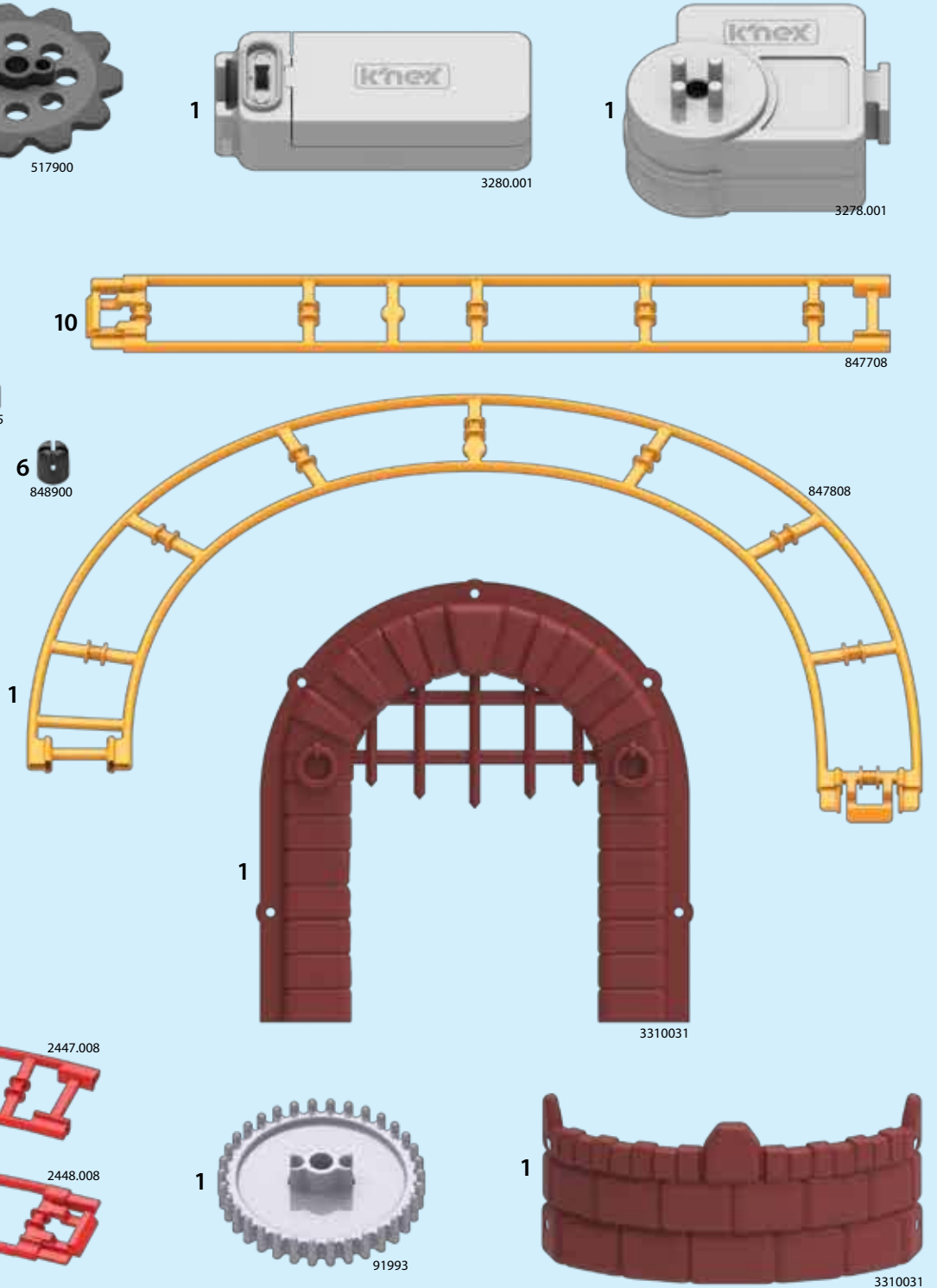

k'nex

Dragon Revenge Roller Coaster

Vengeance du Dragon Montagnes Russes



TIP: While you're building make sure you face your model in the same direction as the pictures show in the instructions.

CONSEIL : Essaye de situer ton modèle dans le même sens que les instructions durant le montage.

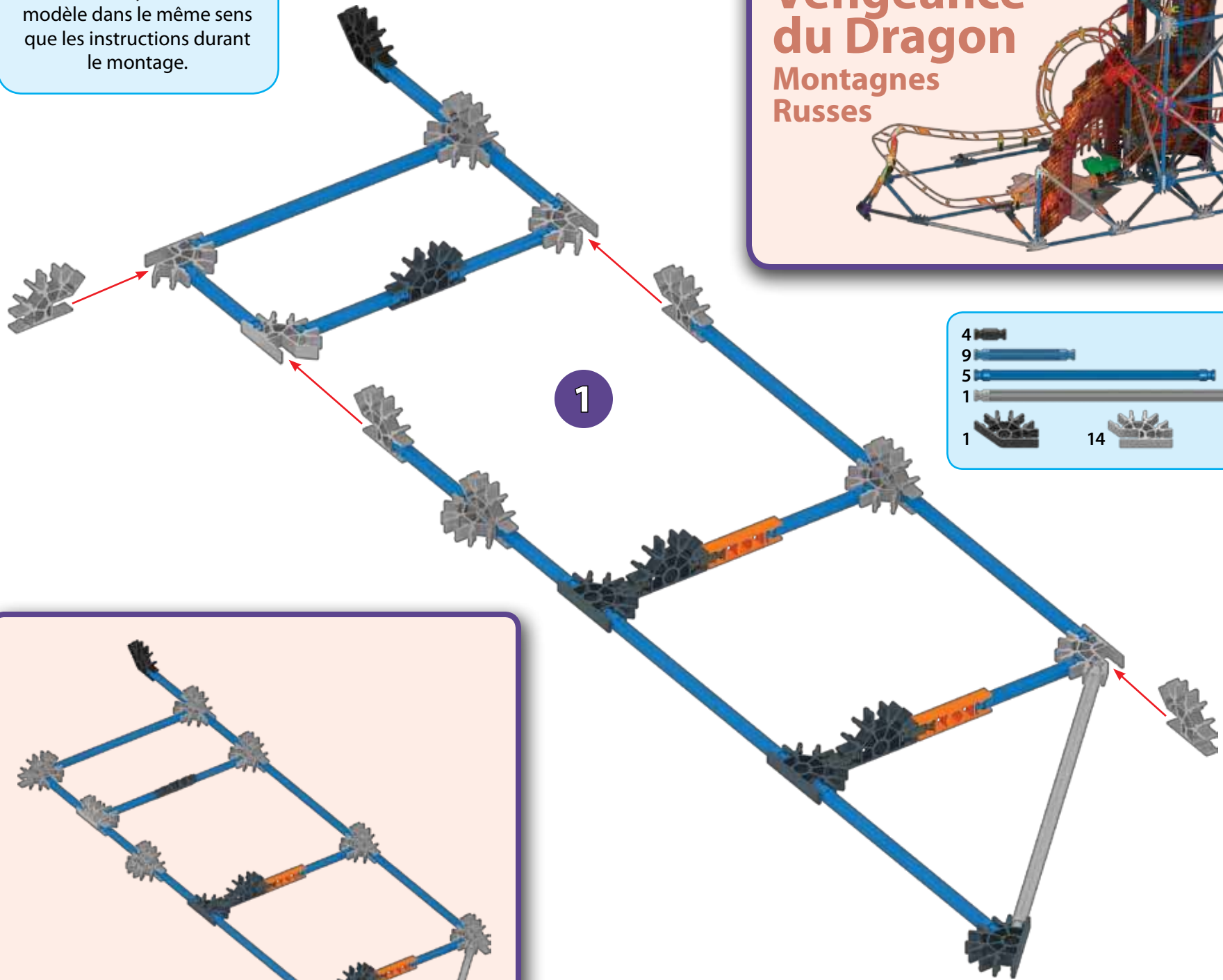

- | | | | |
|---|--|----|--|
| 4 | | 2 | |
| 9 | | | |
| 5 | | | |
| 1 | | | |
| 1 | | 14 | |
| | | 6 | |

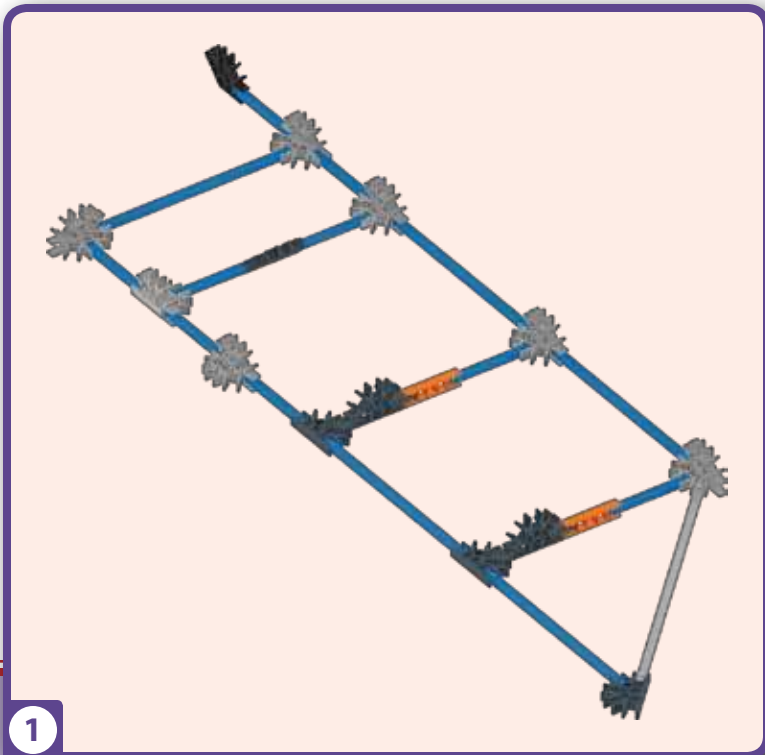

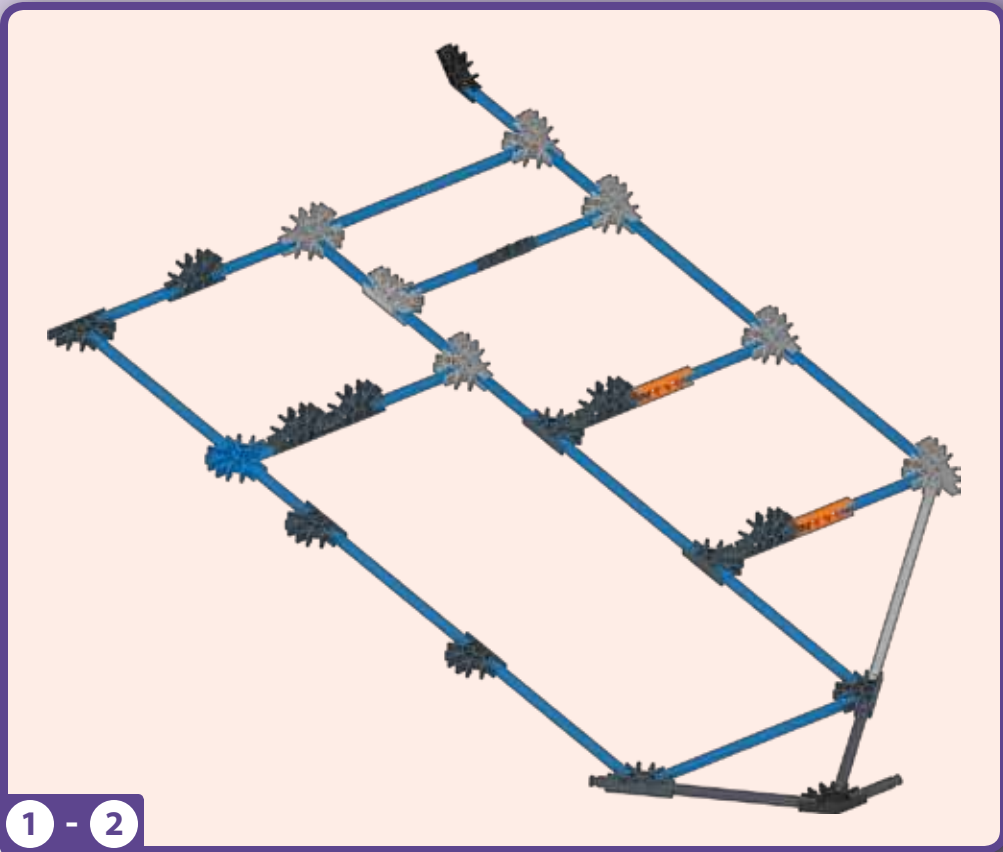

- 3
- 1
- 4
- 2
- 4
- 1
- 1
- 7

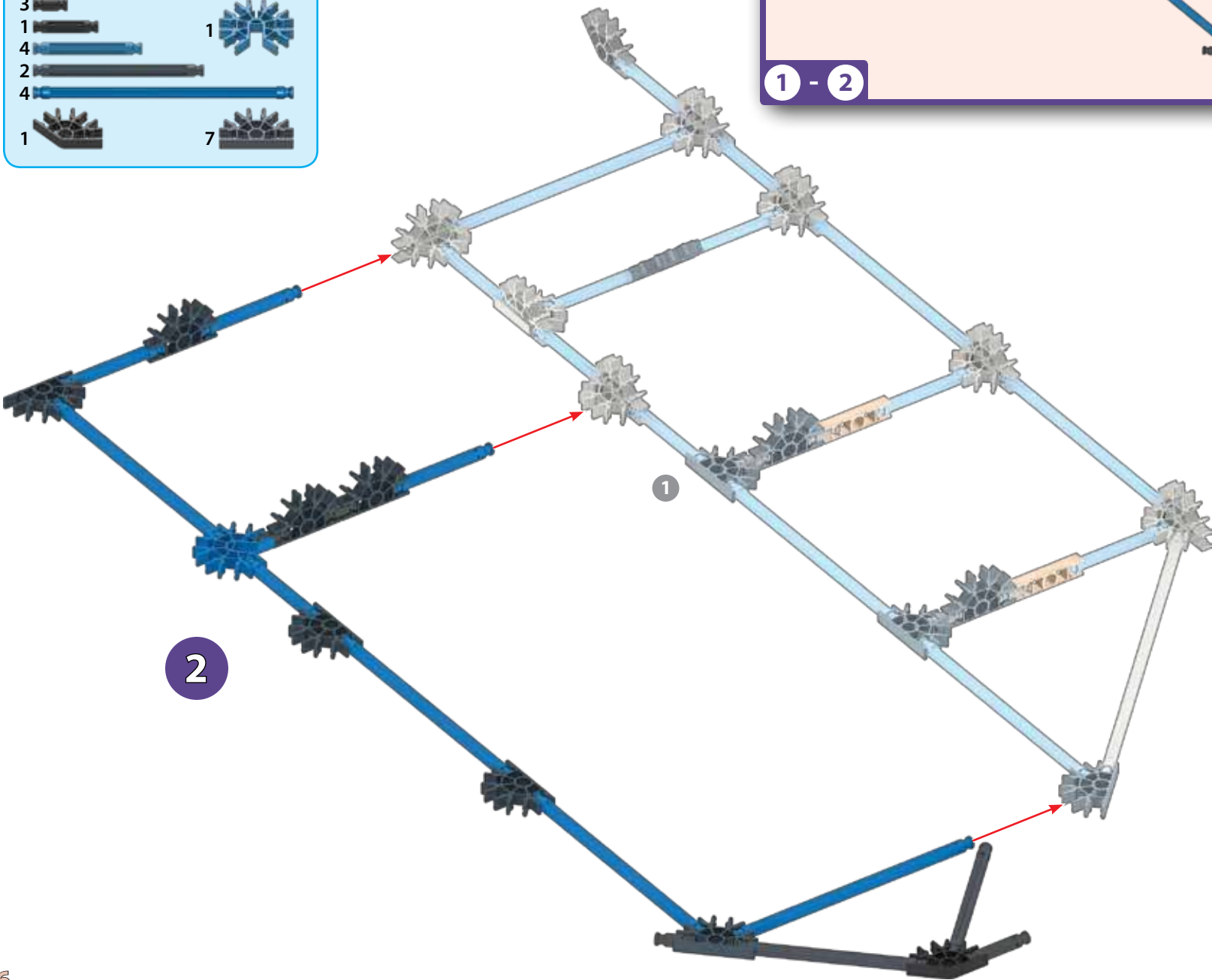

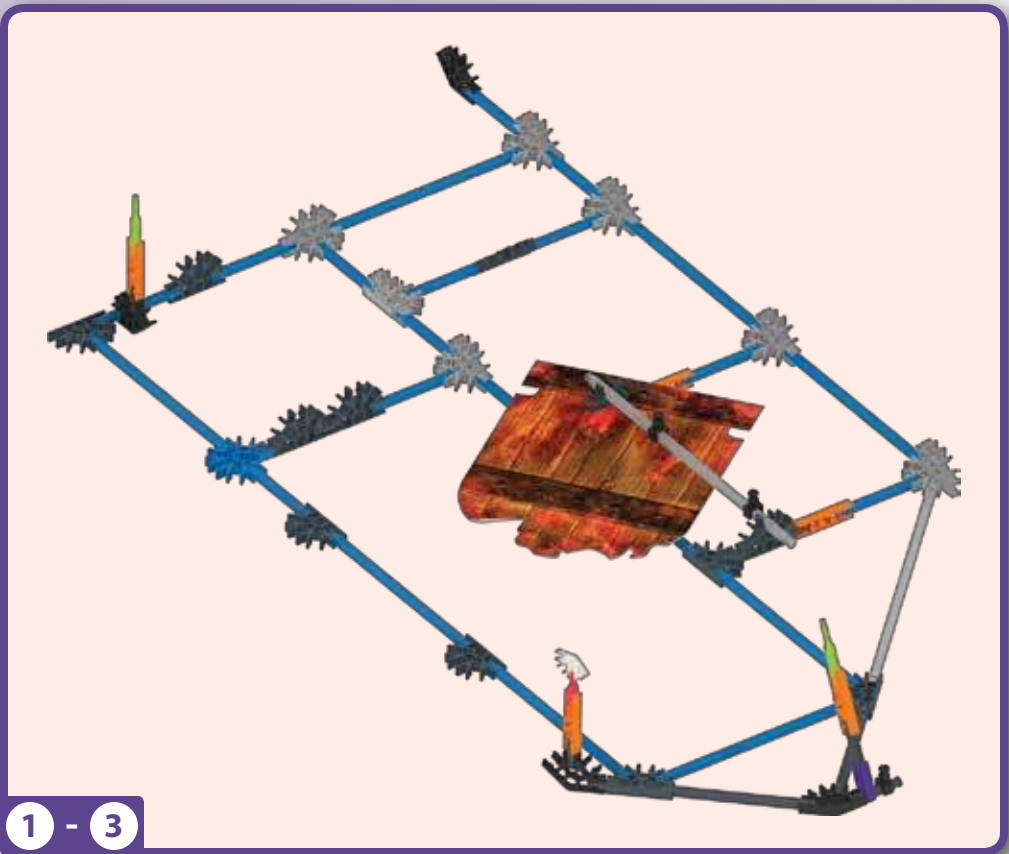

1 - 3

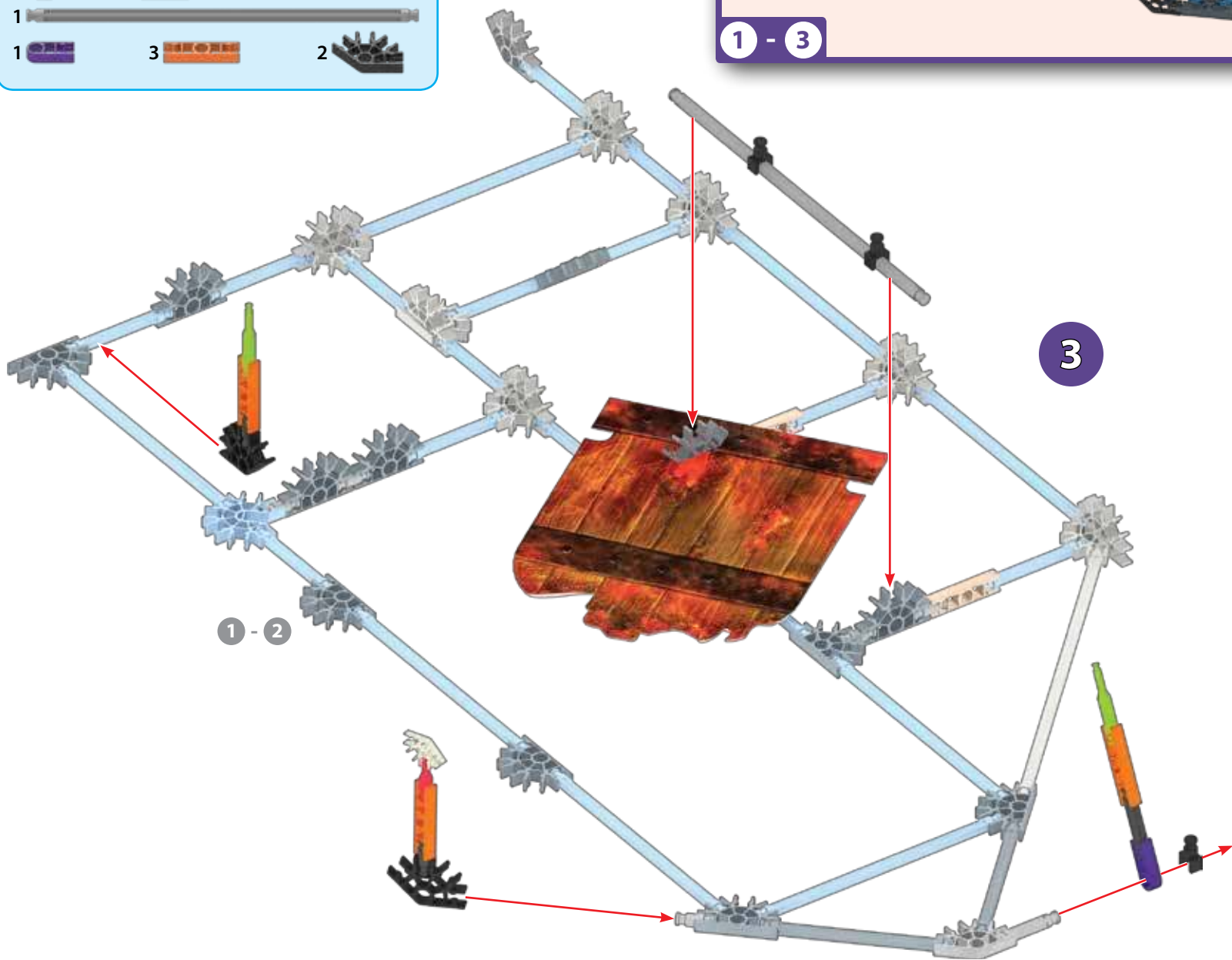
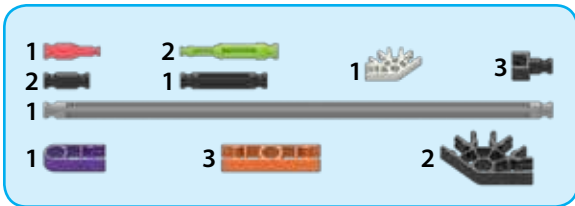

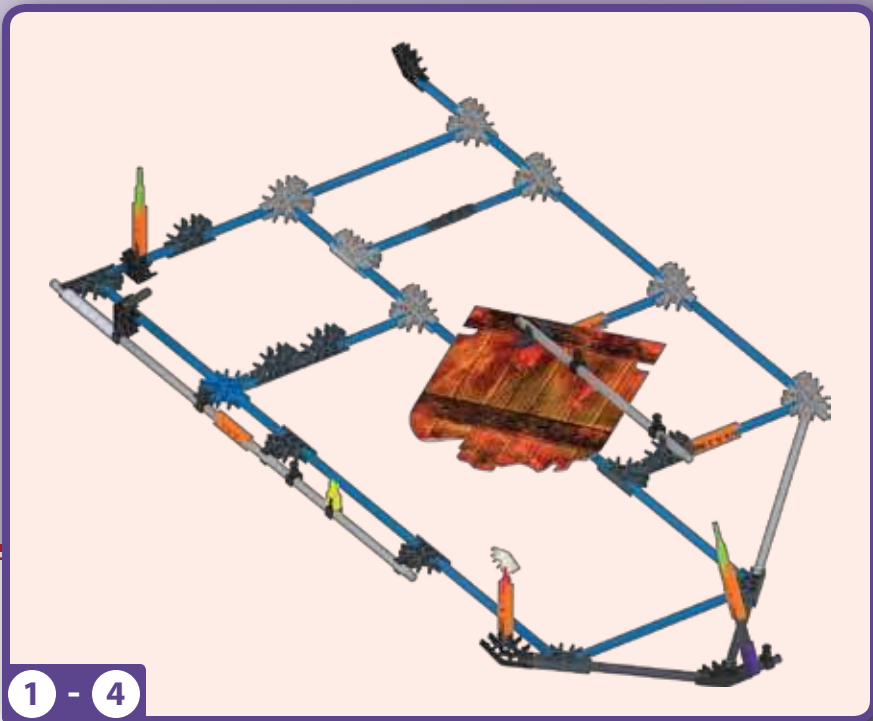

- | | | | | | |
|---|--|---|--|---|--|
| 1 | | 6 | | 1 | |
| 2 | | | | | |
| 8 | | 1 | | 1 | |

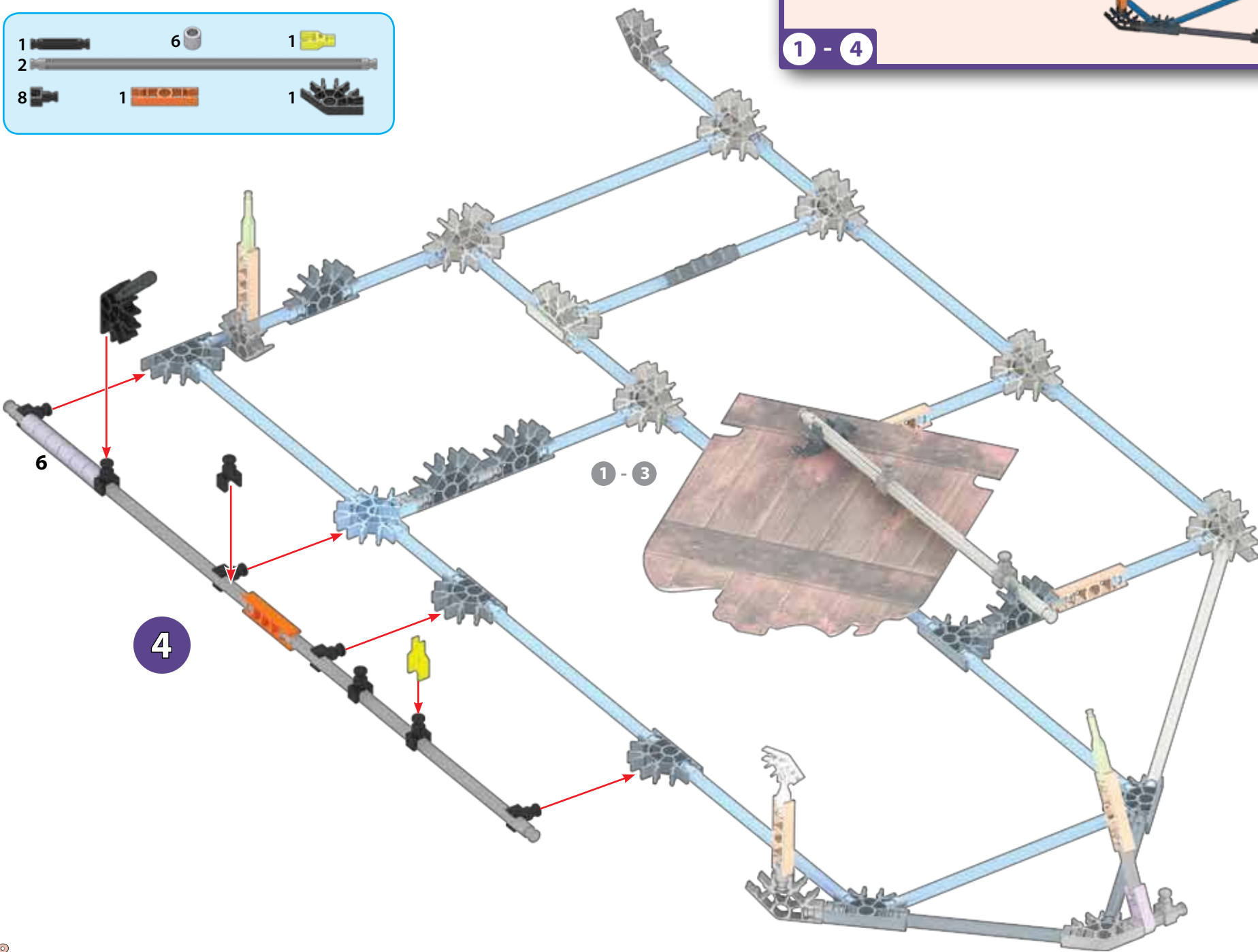

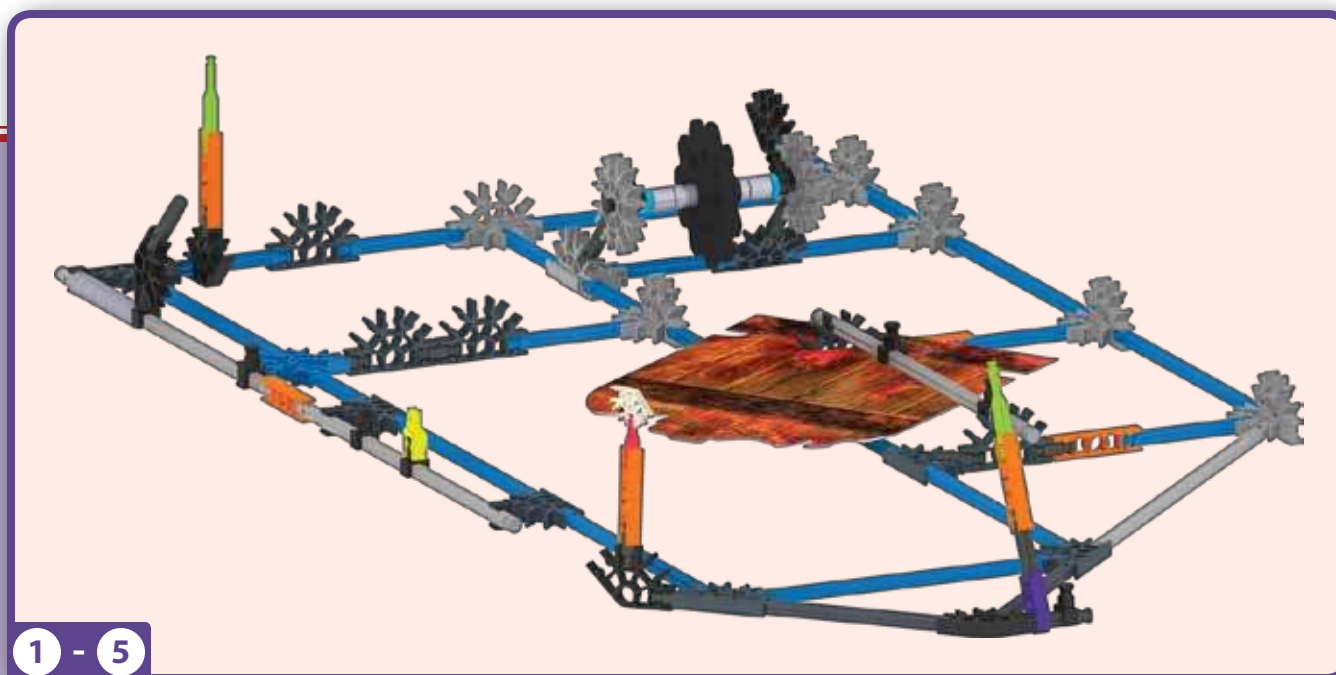
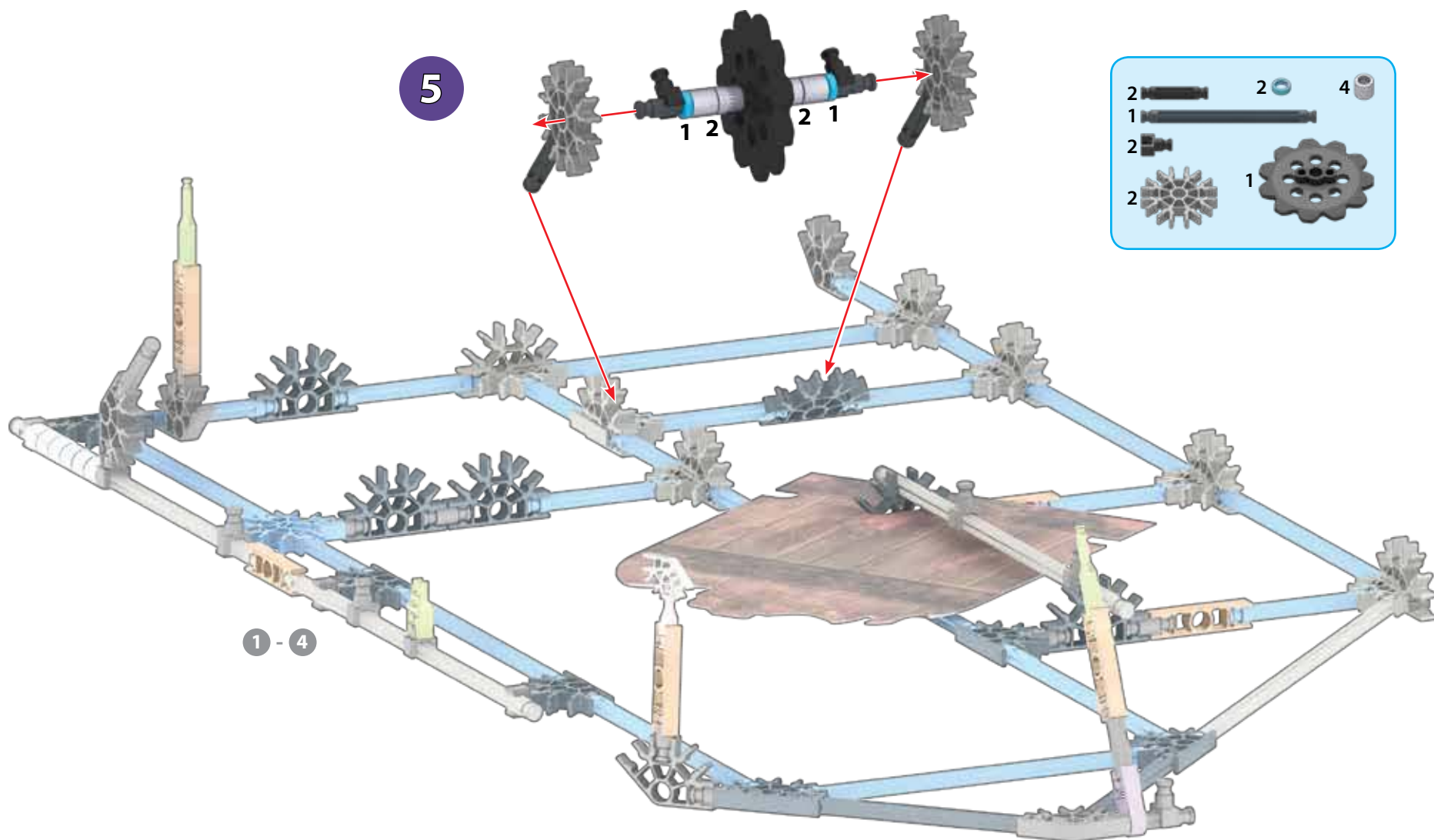

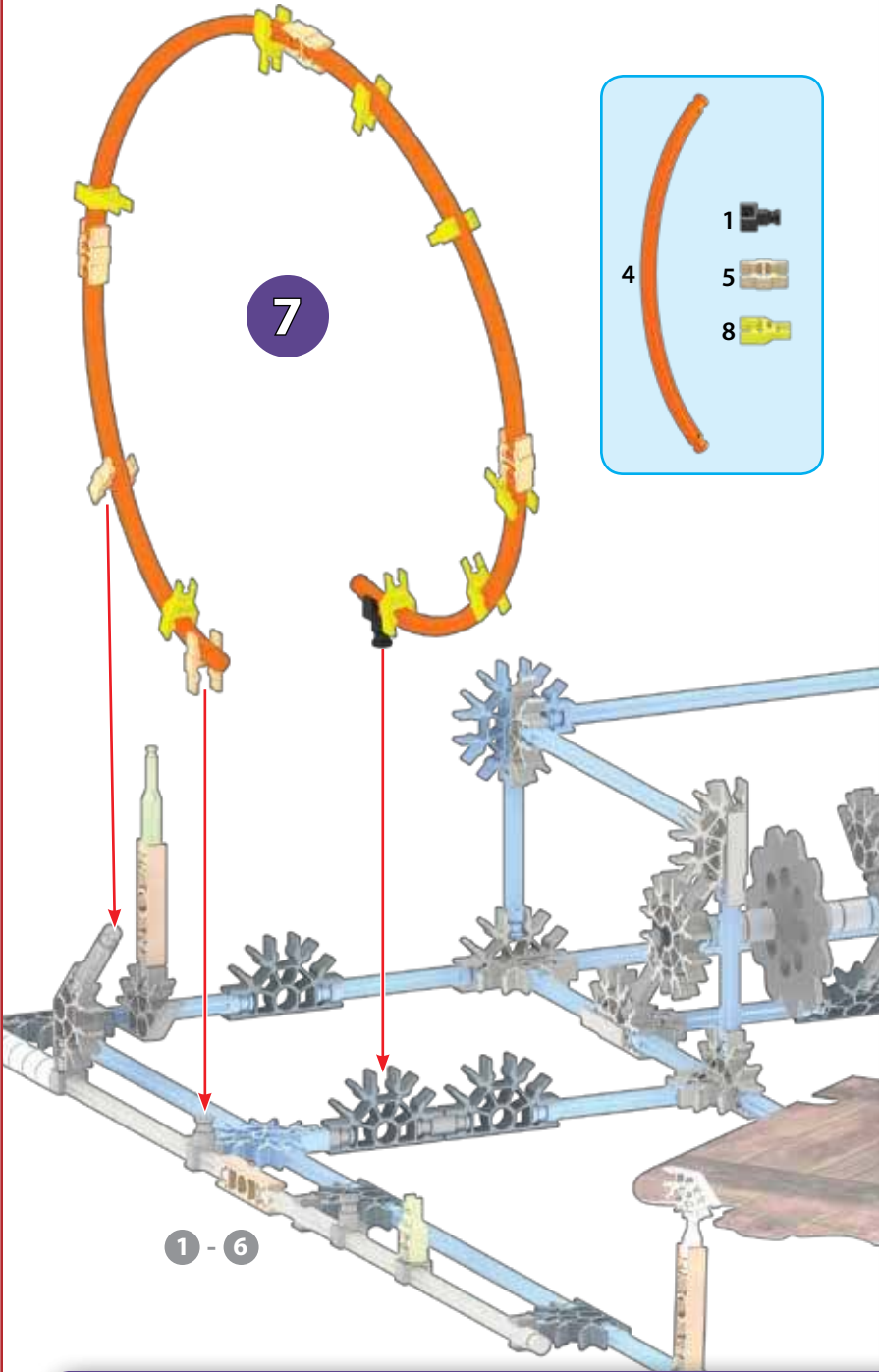
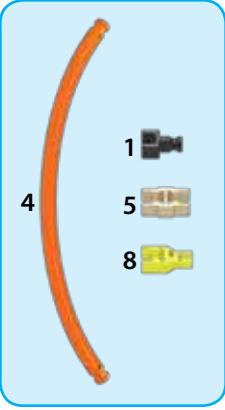
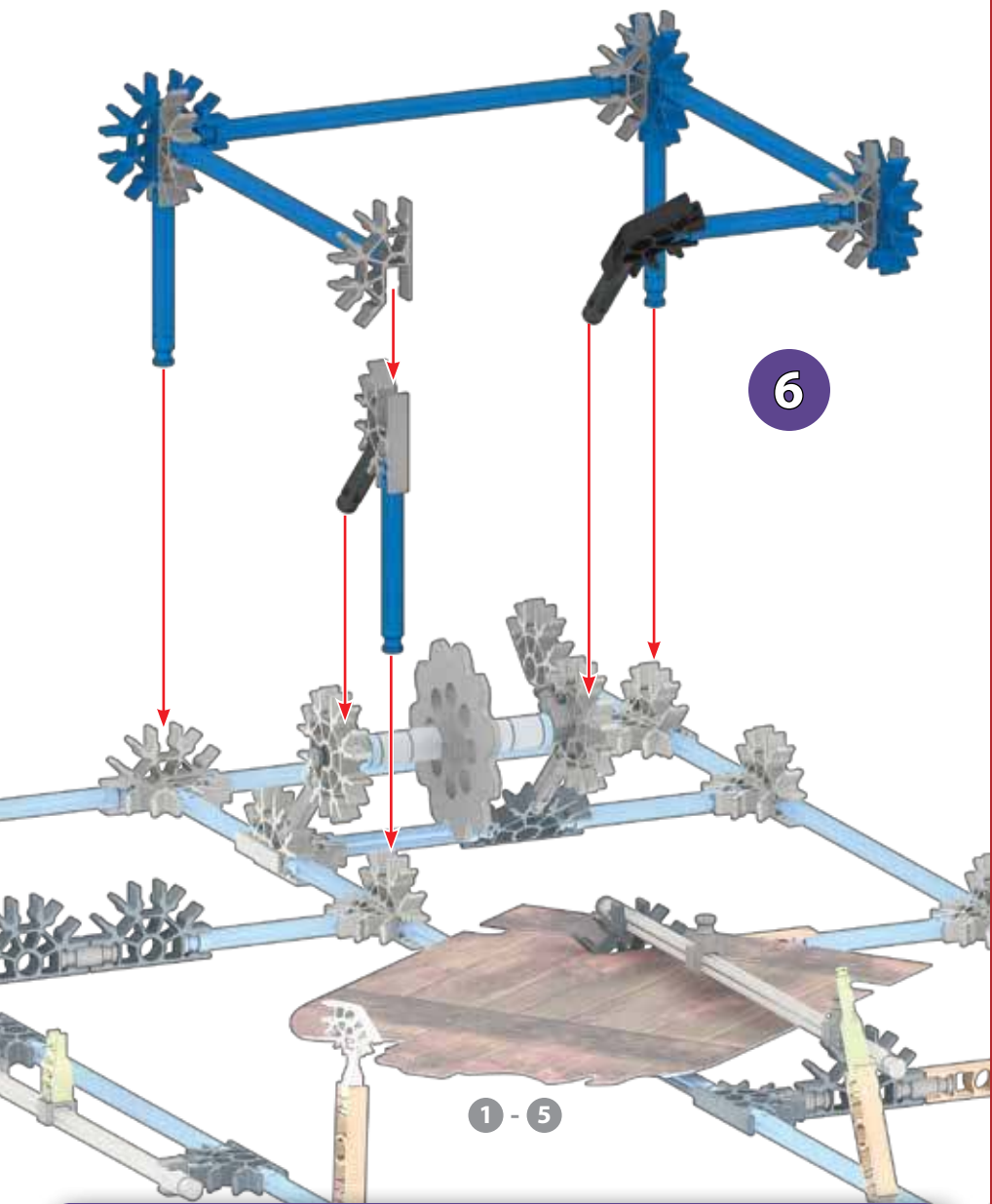

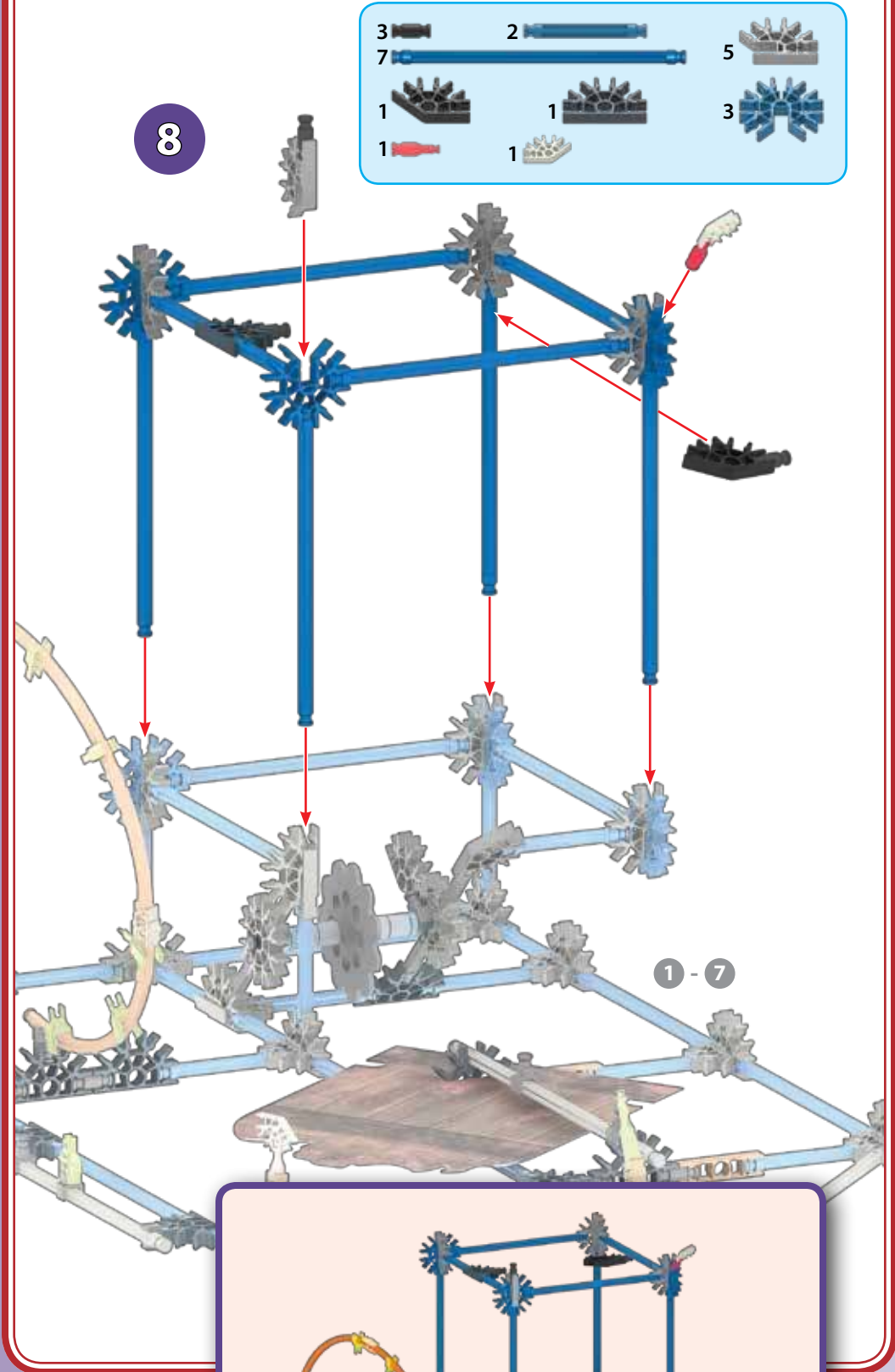

1 - 8

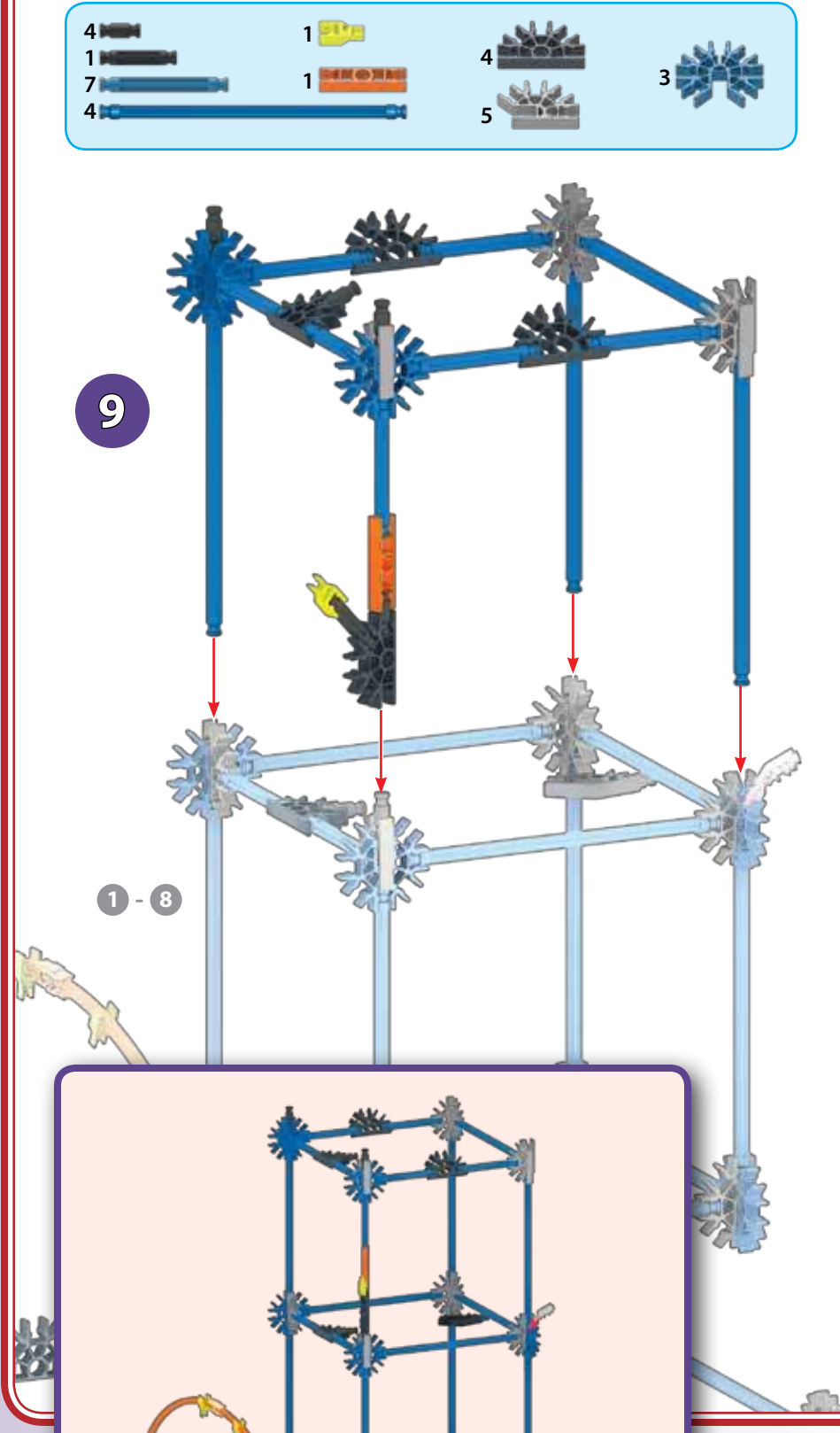

1 - 9

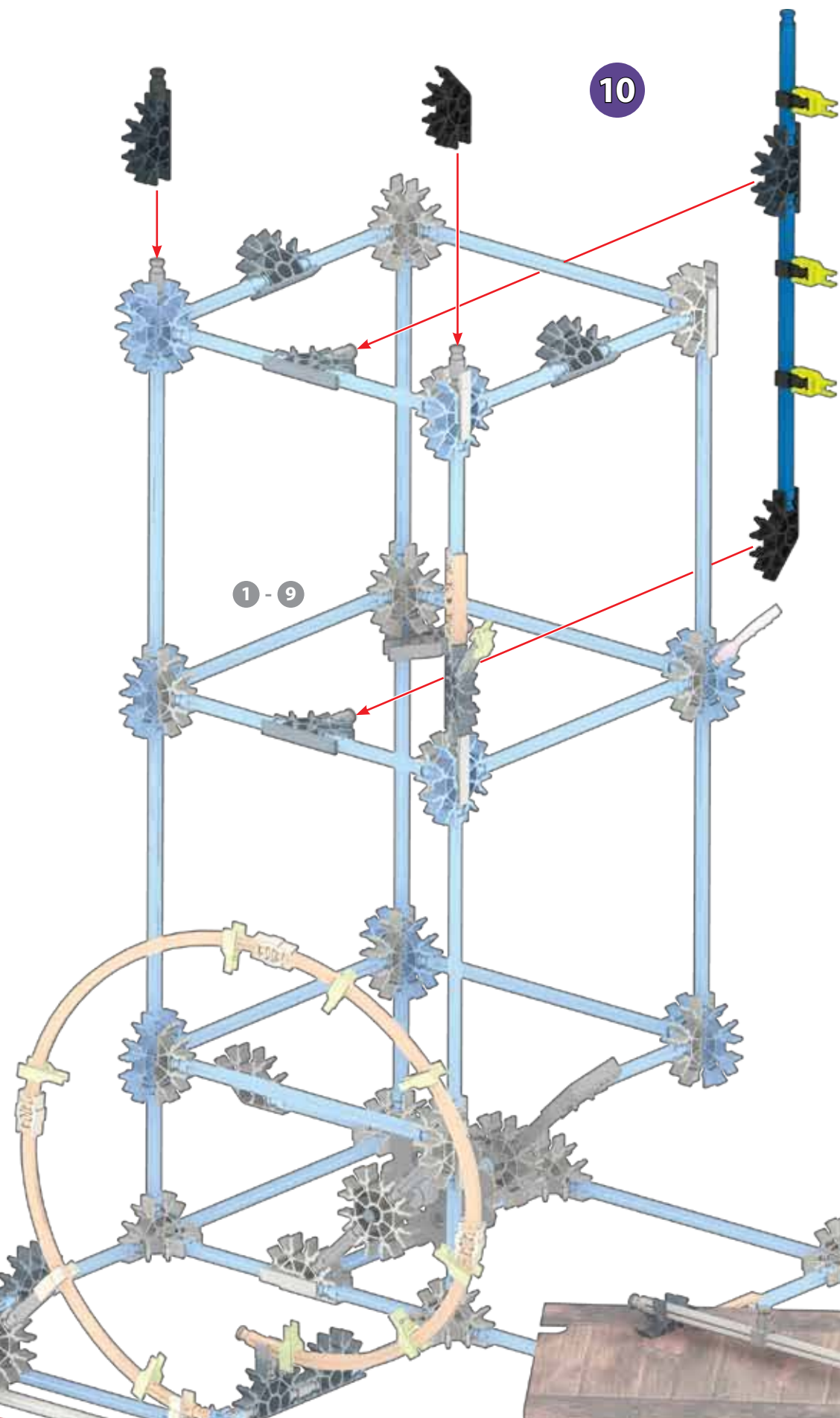

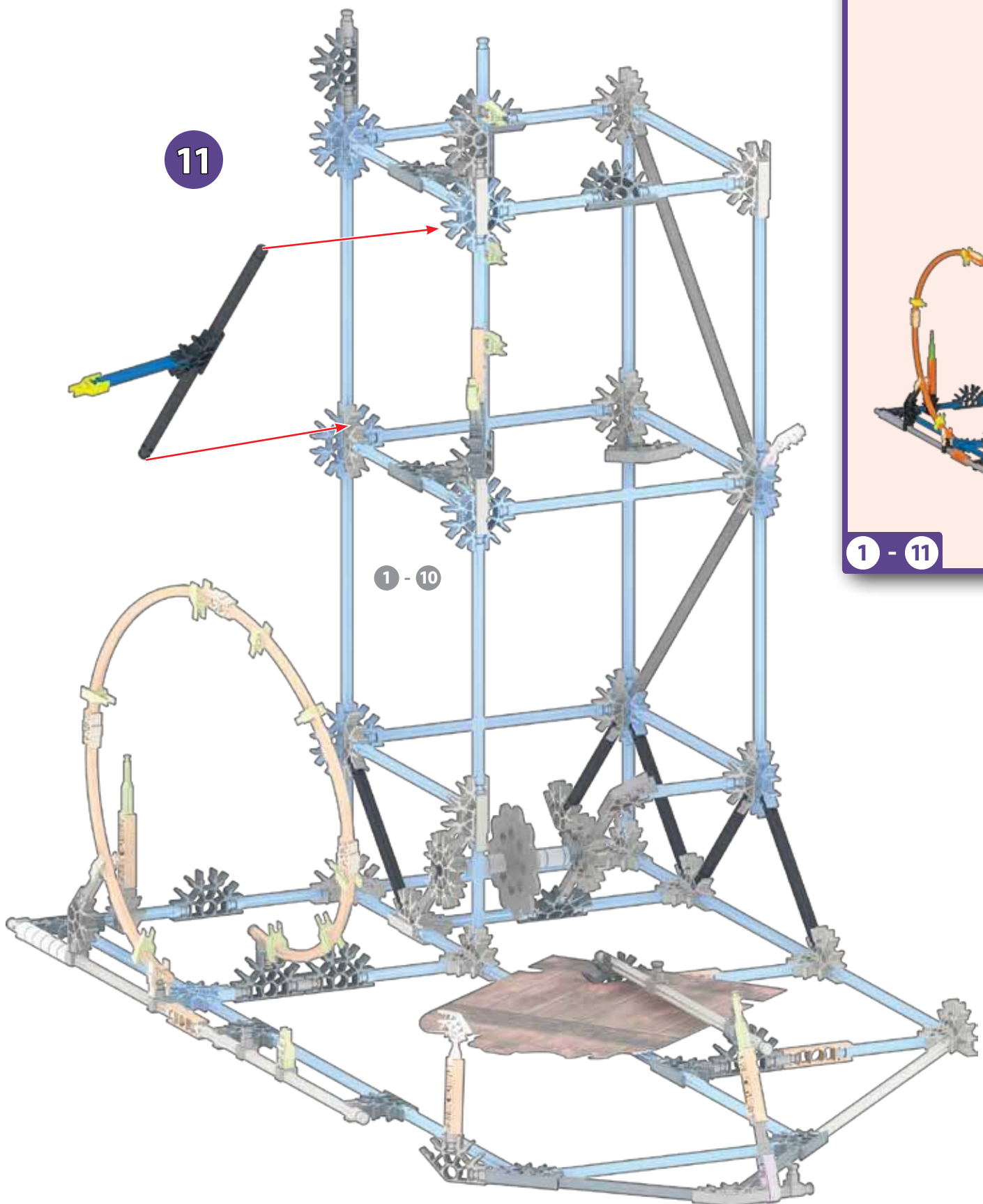
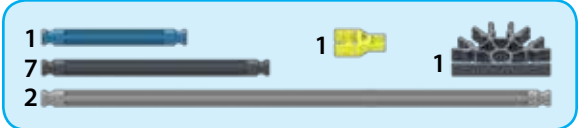

- 2 
- 4 

12

1 - 11

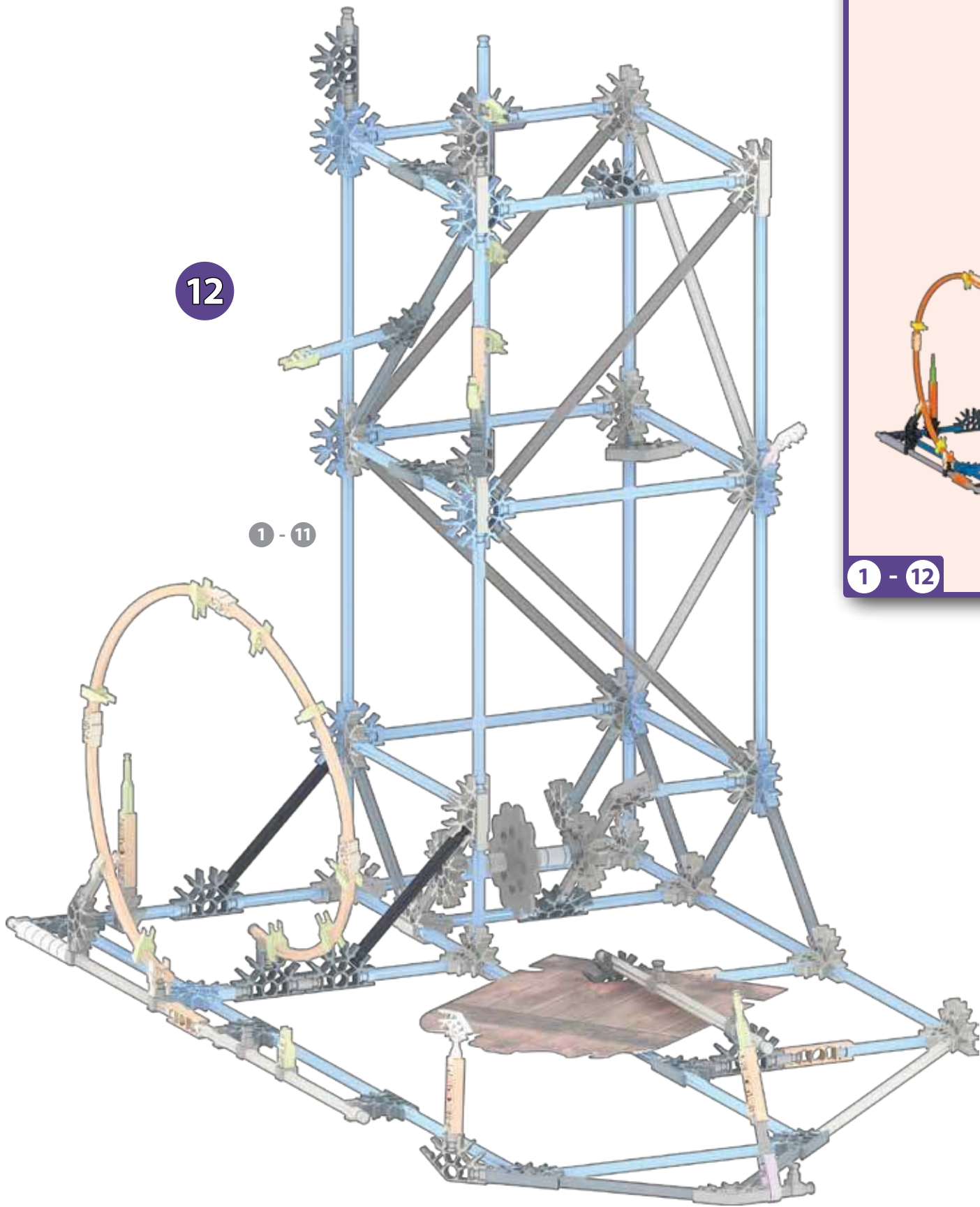

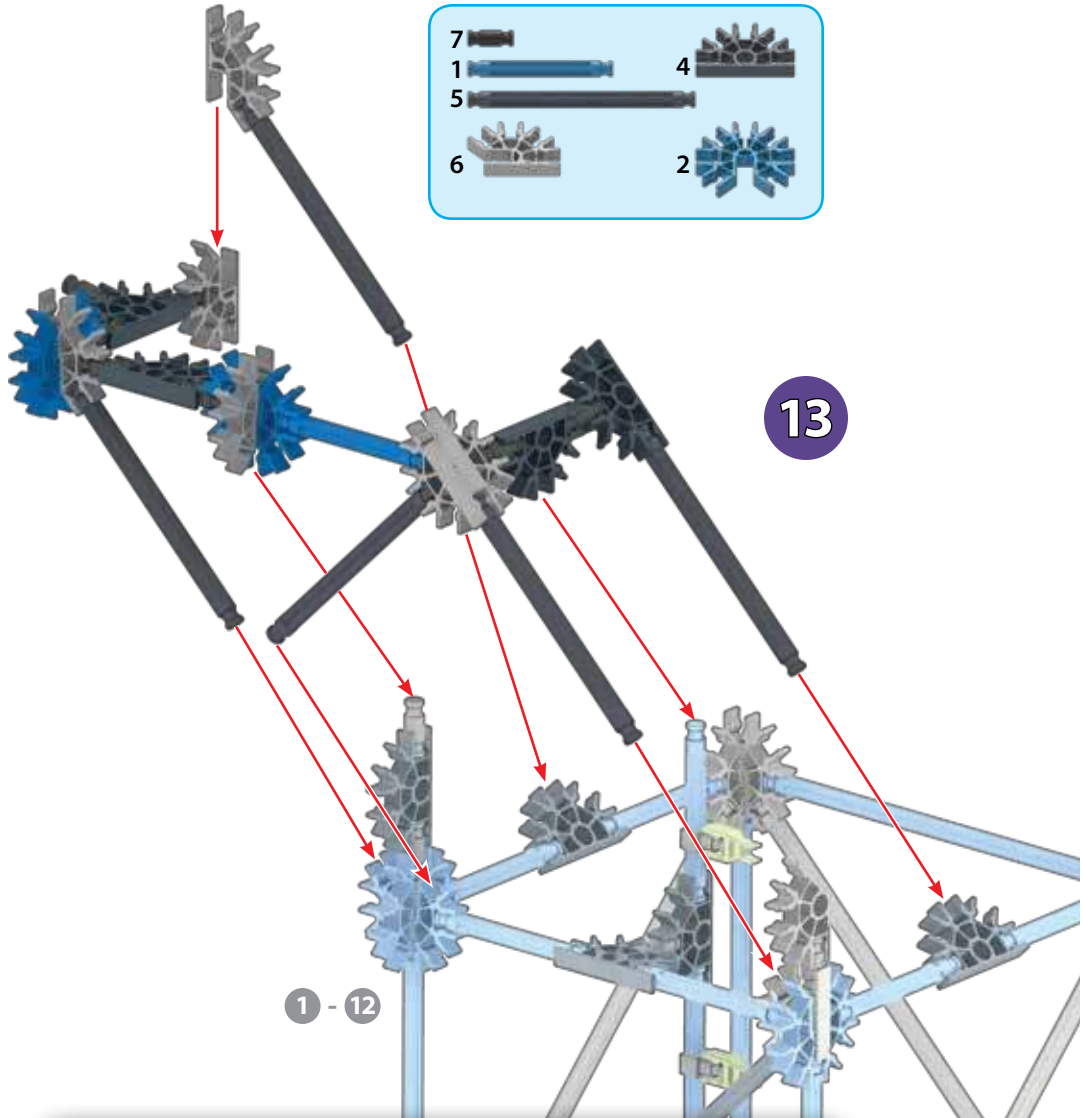
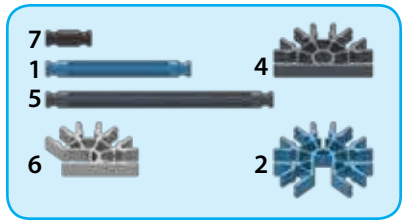

13

1 - 12

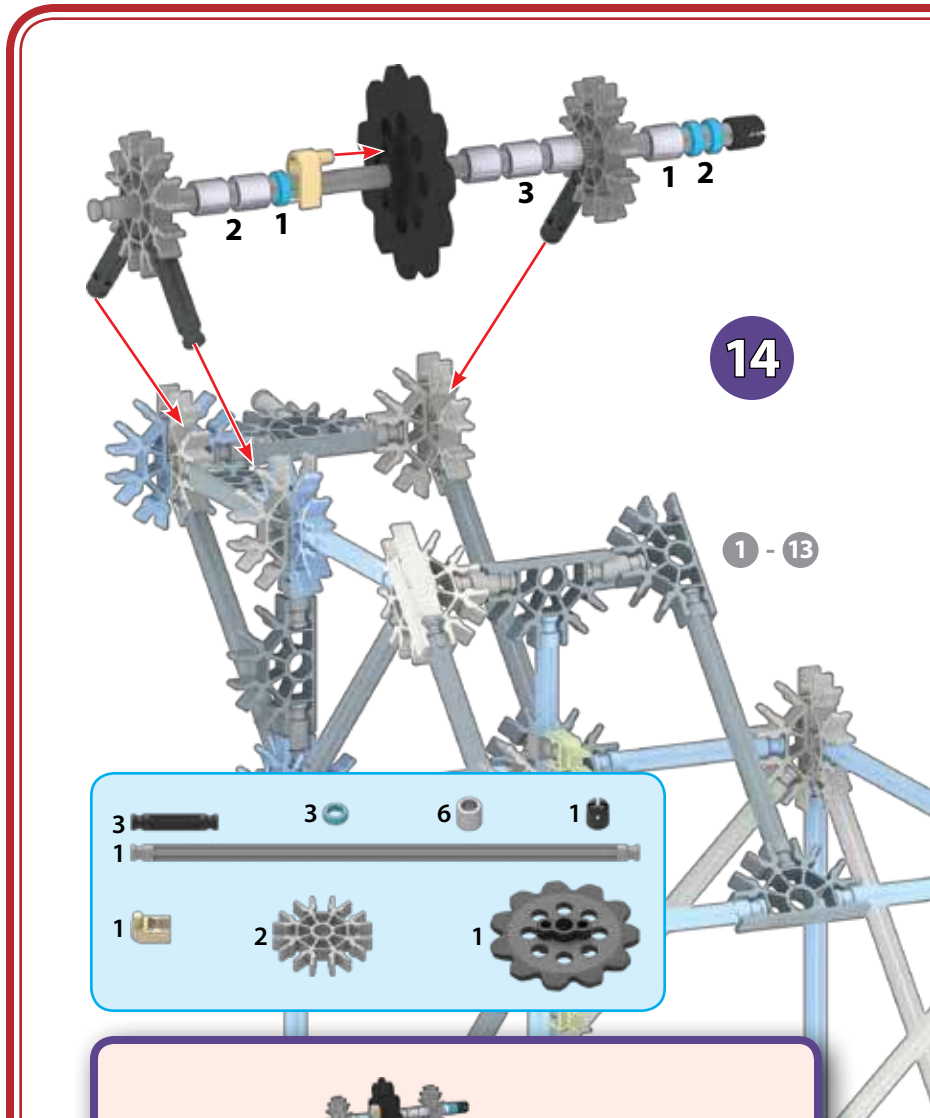

14

1 - 13



1 - 13

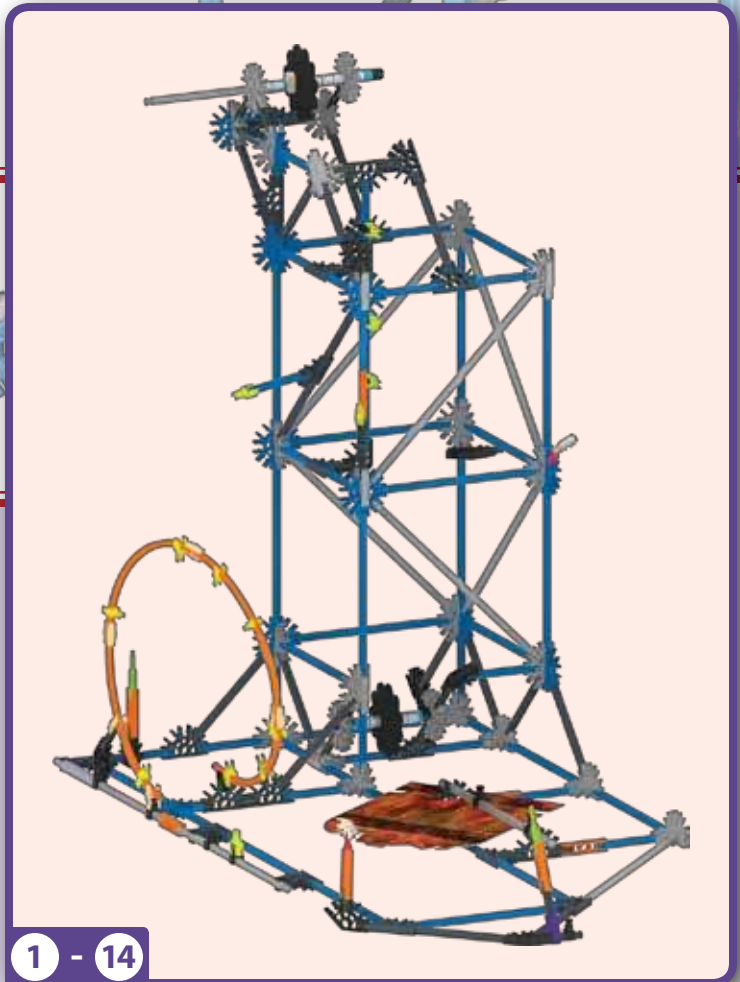

1 - 14

15

- 1 Yellow pin
- 3 Black axle
- 3 Black axle
- 5 Blue axle
- 2 Black axle
- 3 Grey axle
- 2 Grey axle
- 1 Blue gear

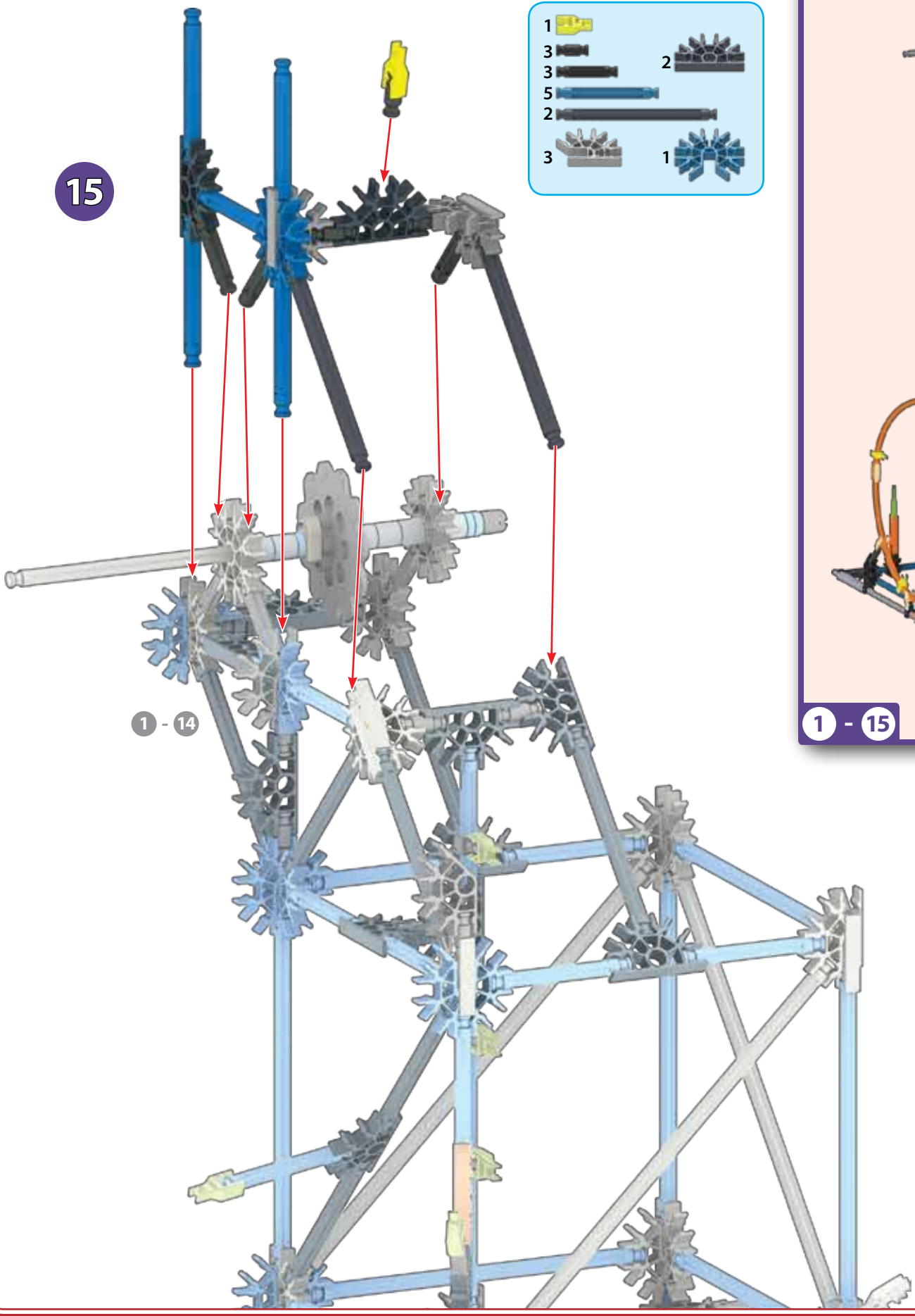

1 - 15

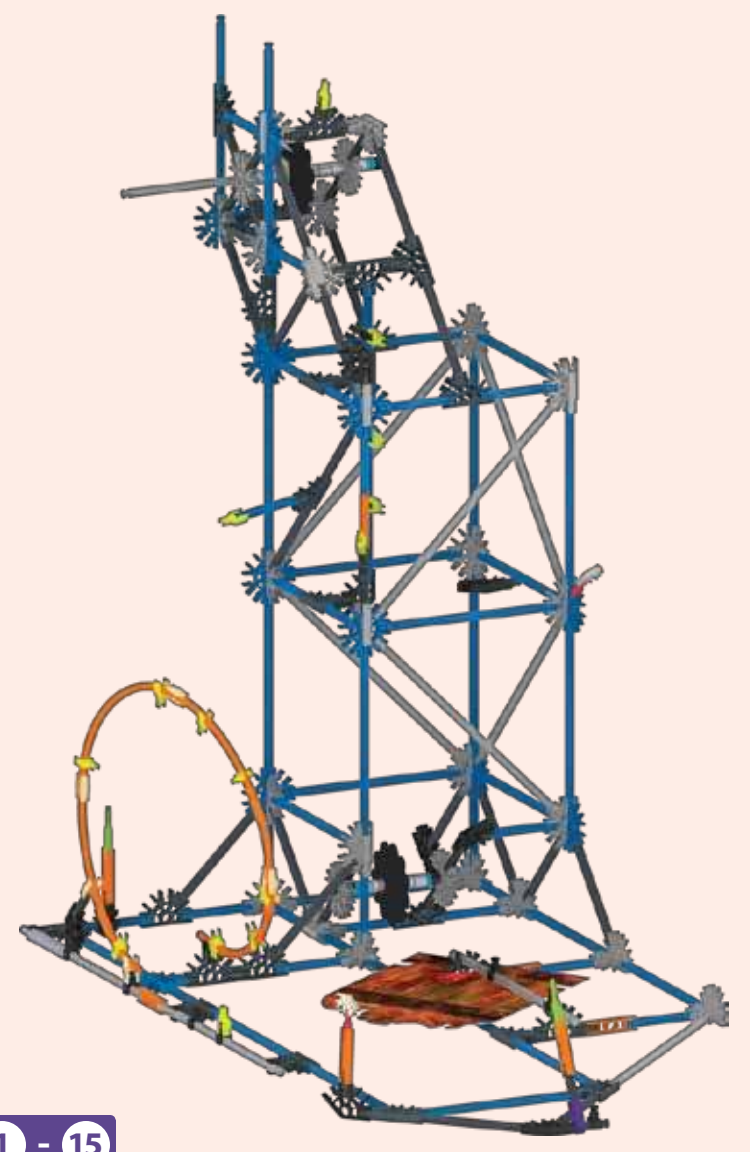

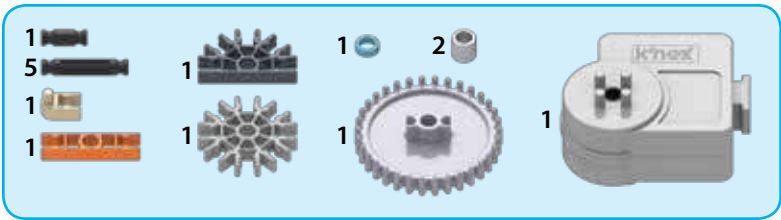

16

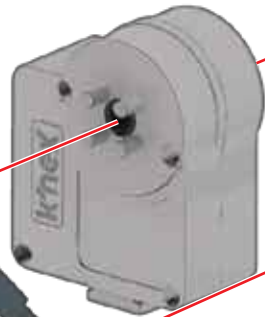
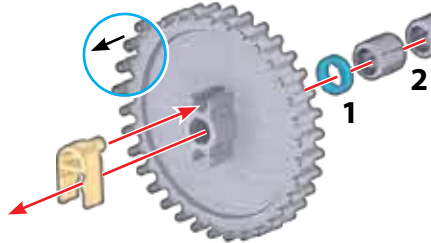

1 - 15

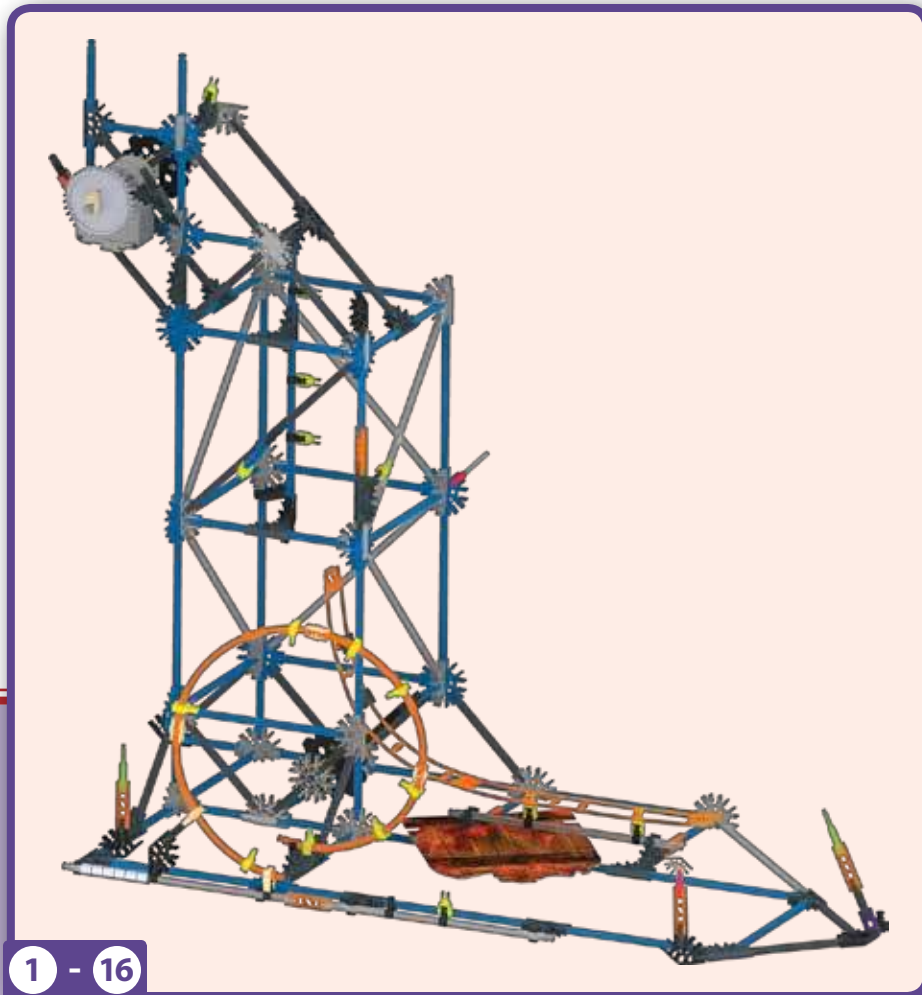
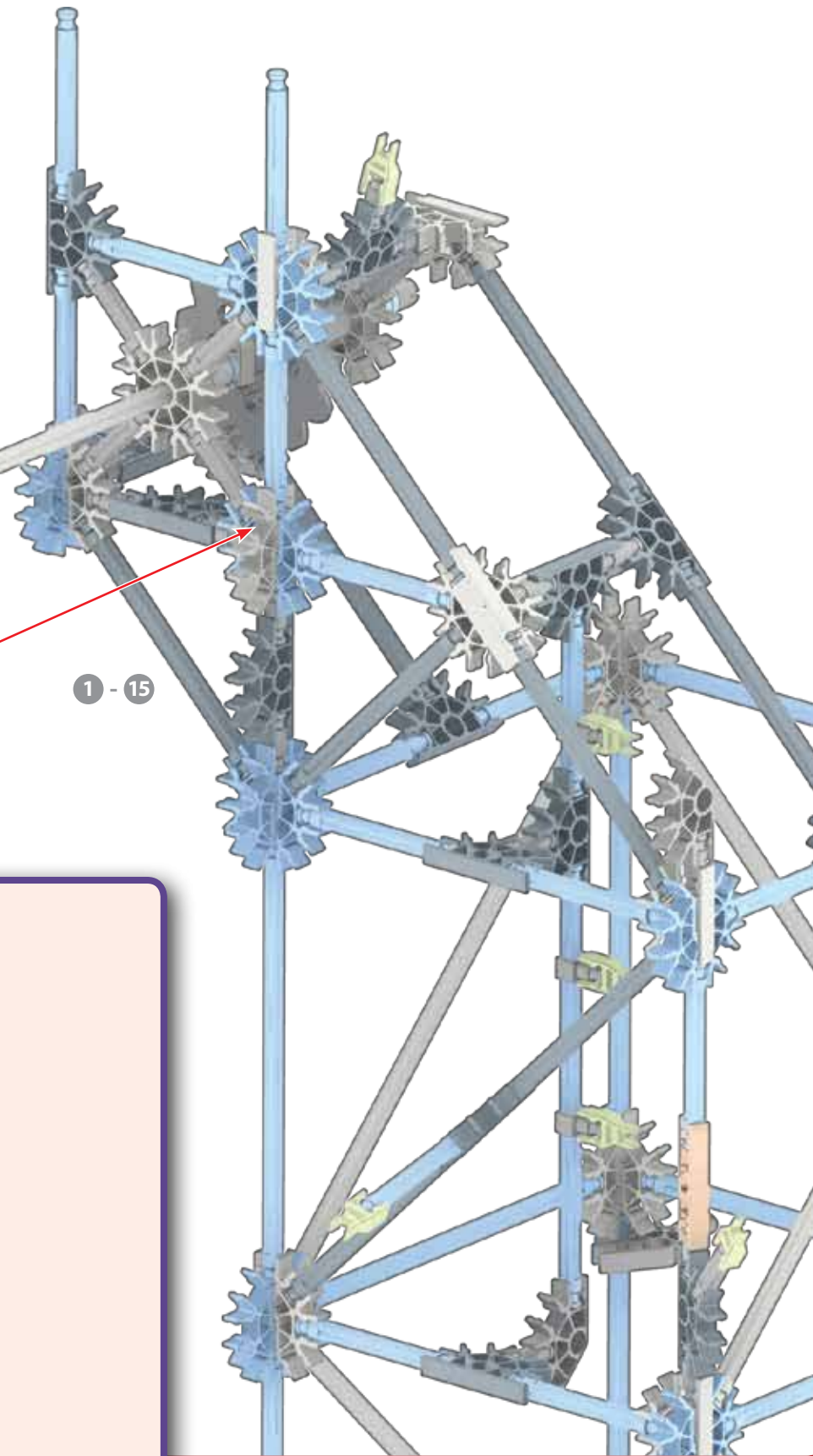

1 - 16

17

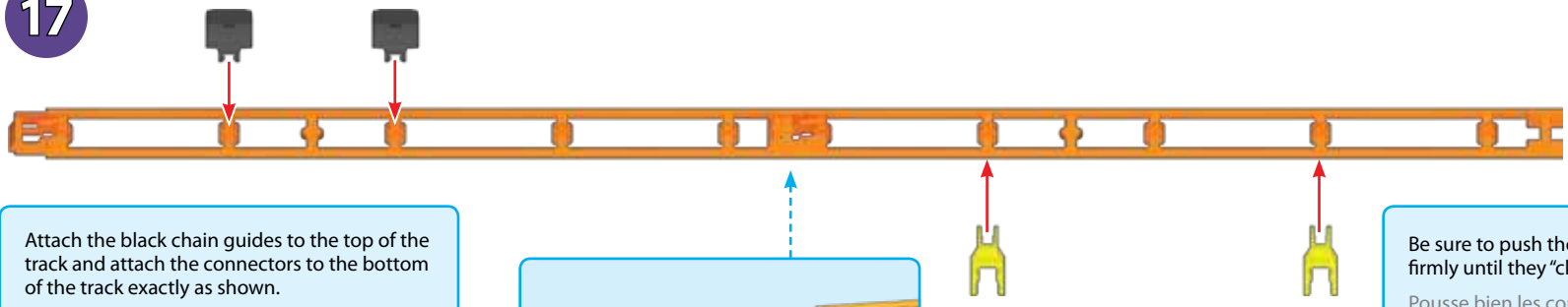

Attach the black chain guides to the top of the track and attach the connectors to the bottom of the track exactly as shown.

Fixe les guides de chaîne à la partie supérieure du circuit. Fixe les connecteurs à la partie inférieure du circuit exactement comme l'indique le schéma.

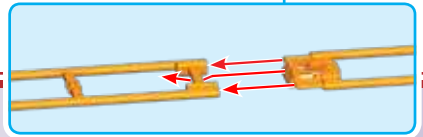

Be sure to push the connectors on firmly until they "click".

Pousse bien les connecteurs jusqu'à ce qu'ils « clizquent ».

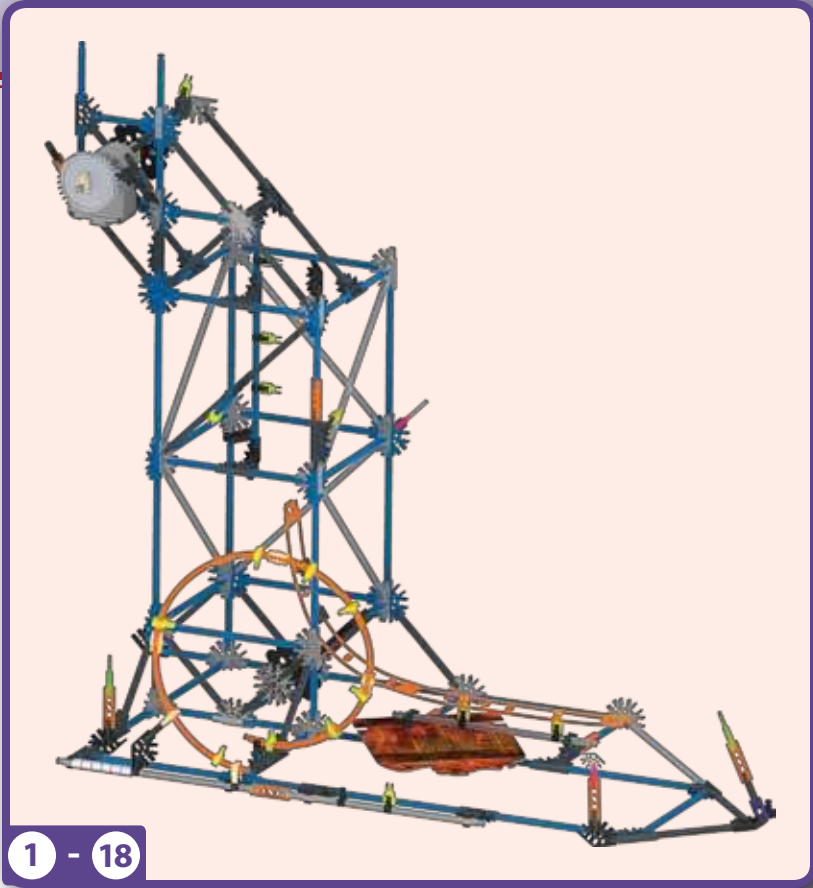
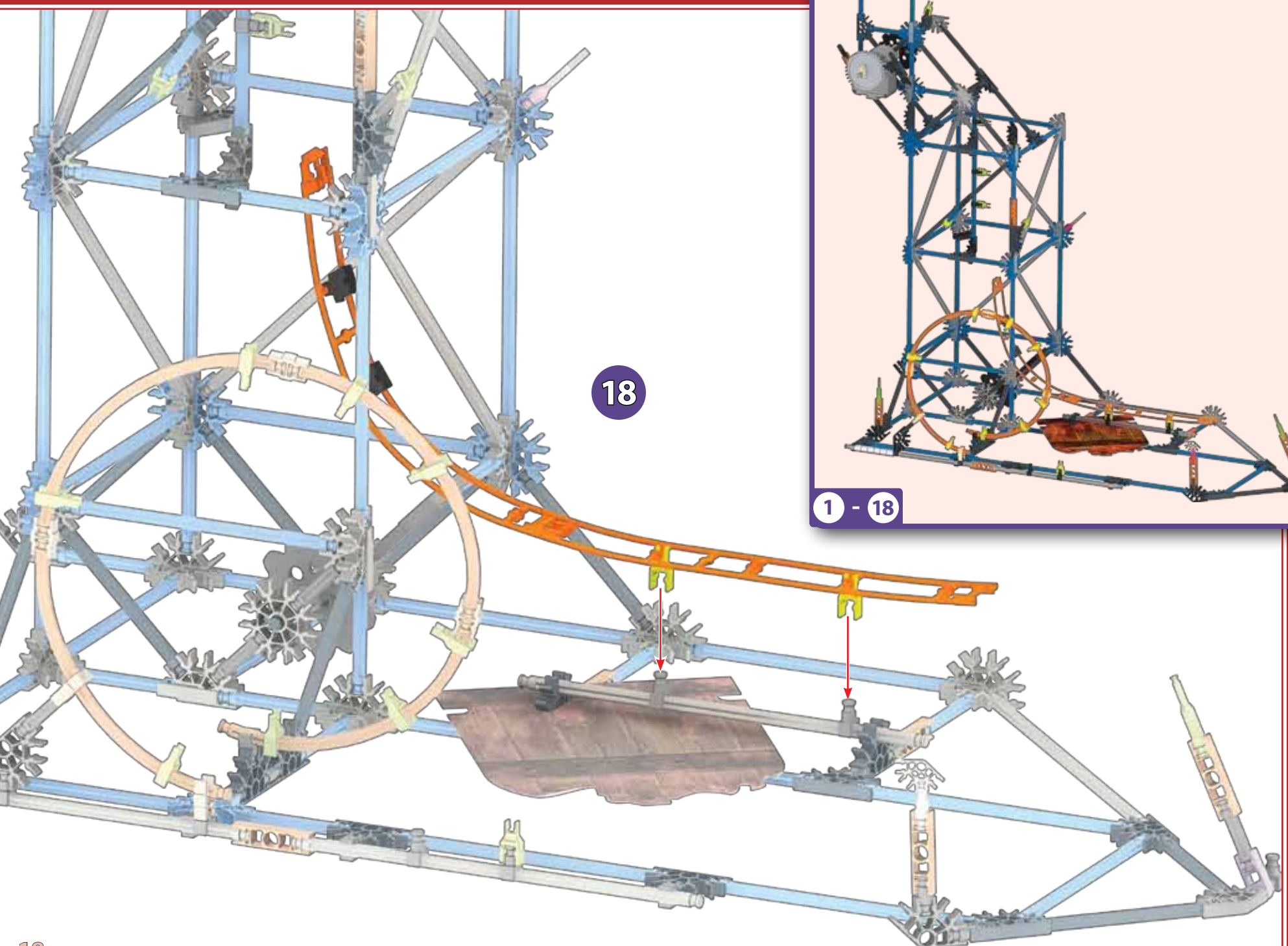

19

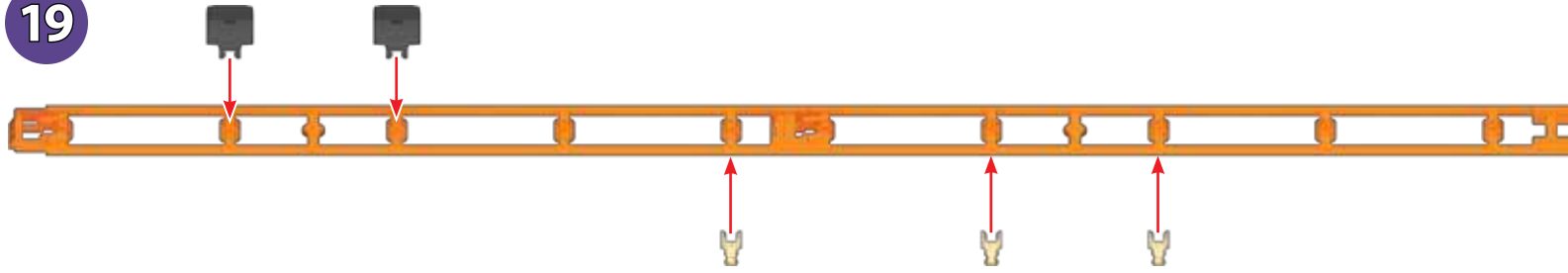

20

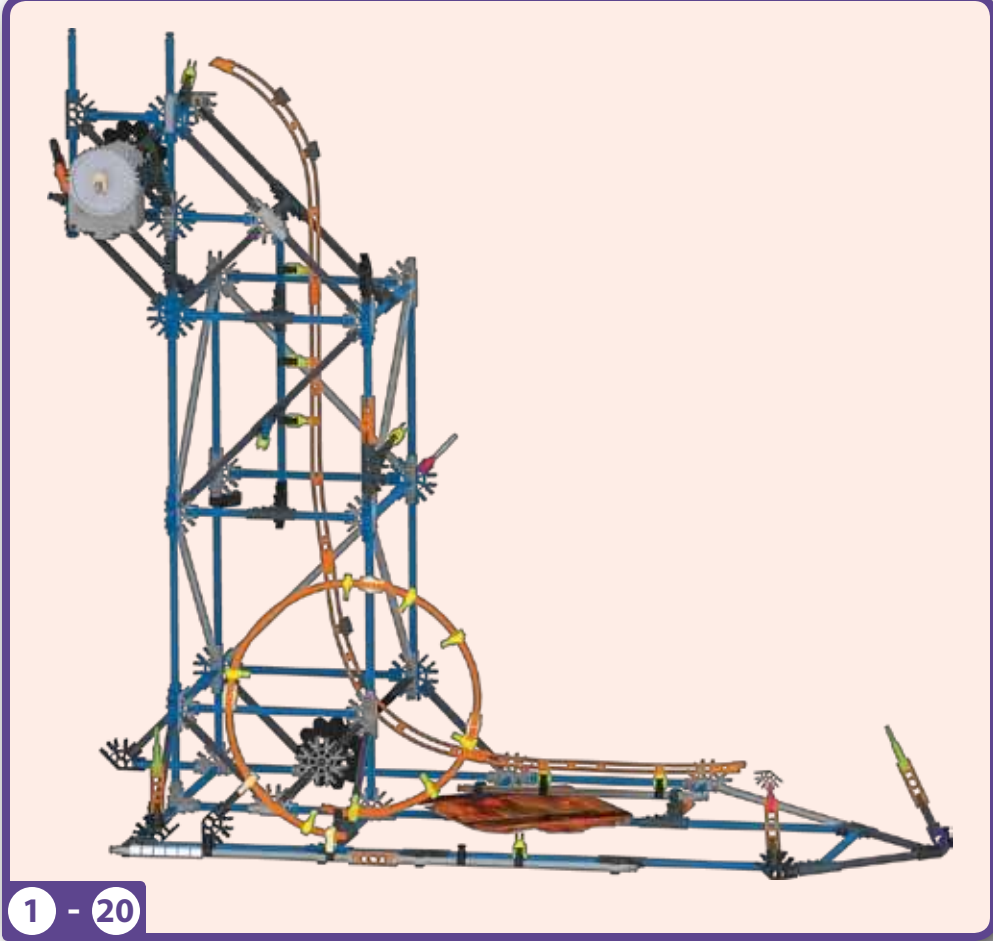
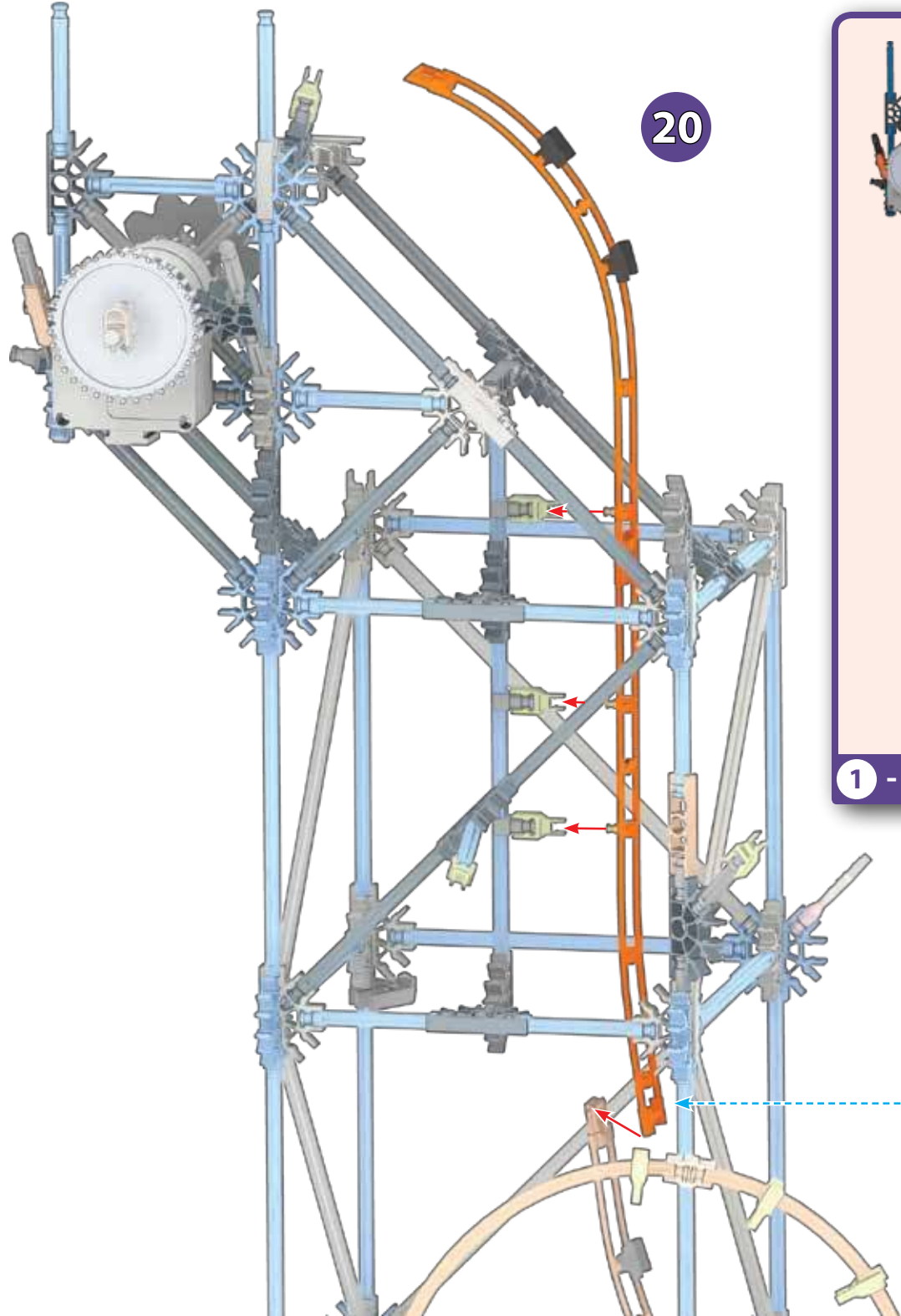

Always join this end of the track to the previous track piece first, then connect the rest of the track to the tower.

Toujours joindre à cette extrémité de la voie à la pièce de la piste précédente, puis connecter le reste de la piste à la tour.

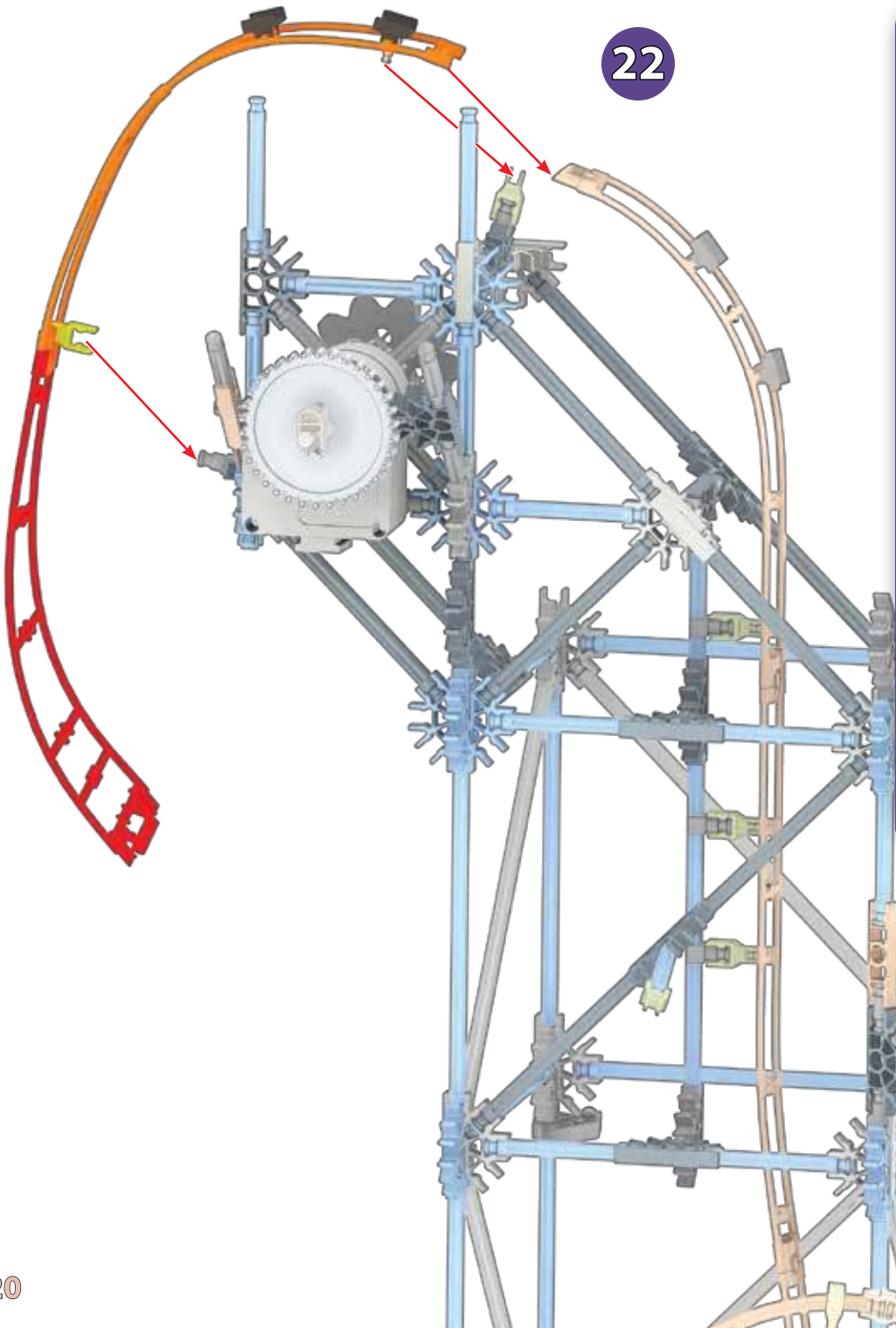
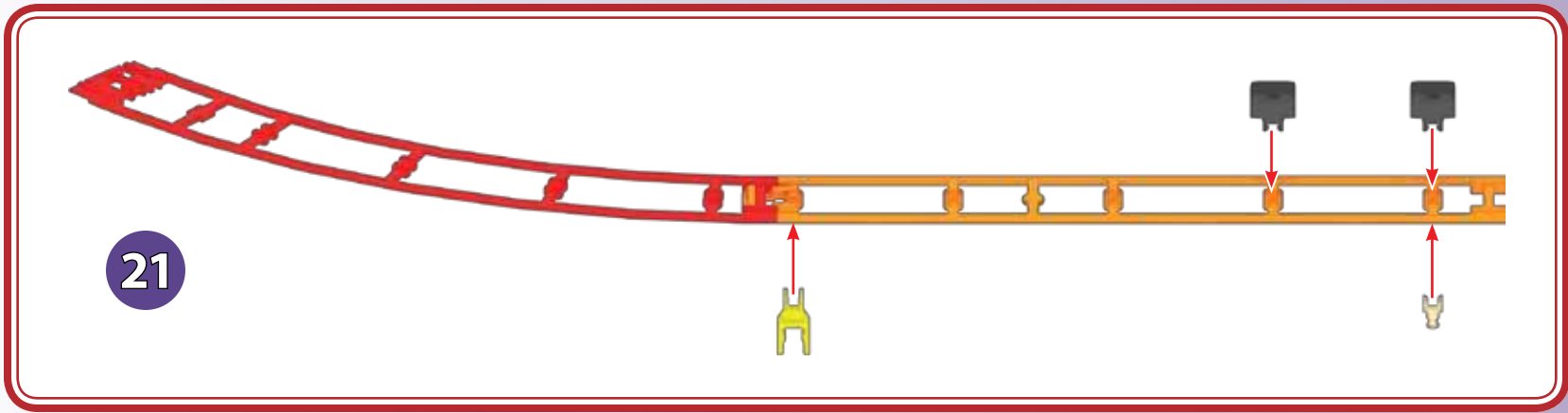

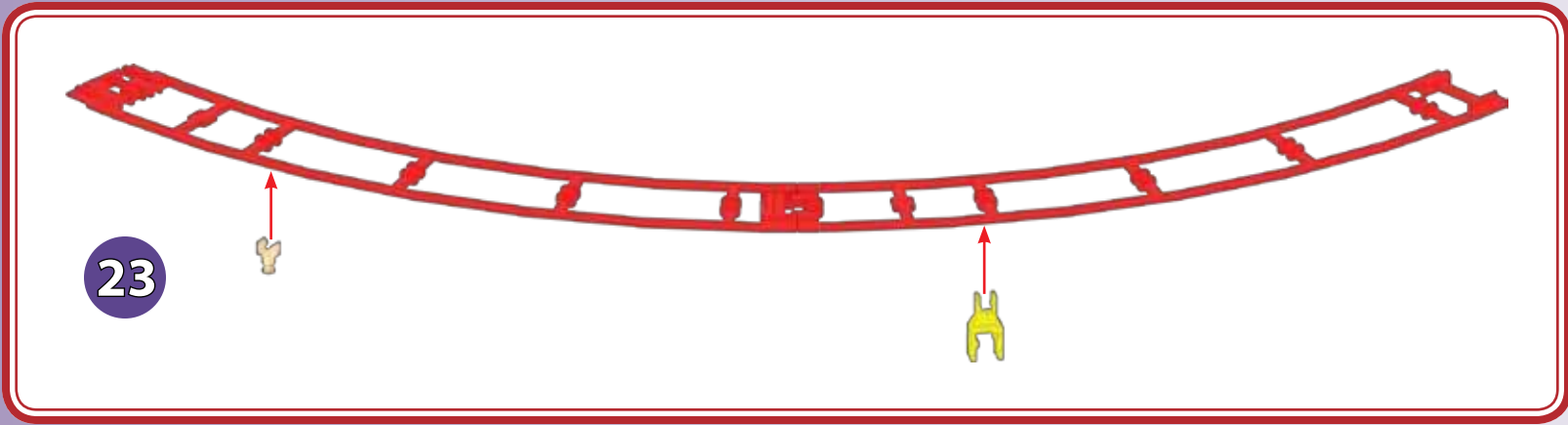

23



1 - 24

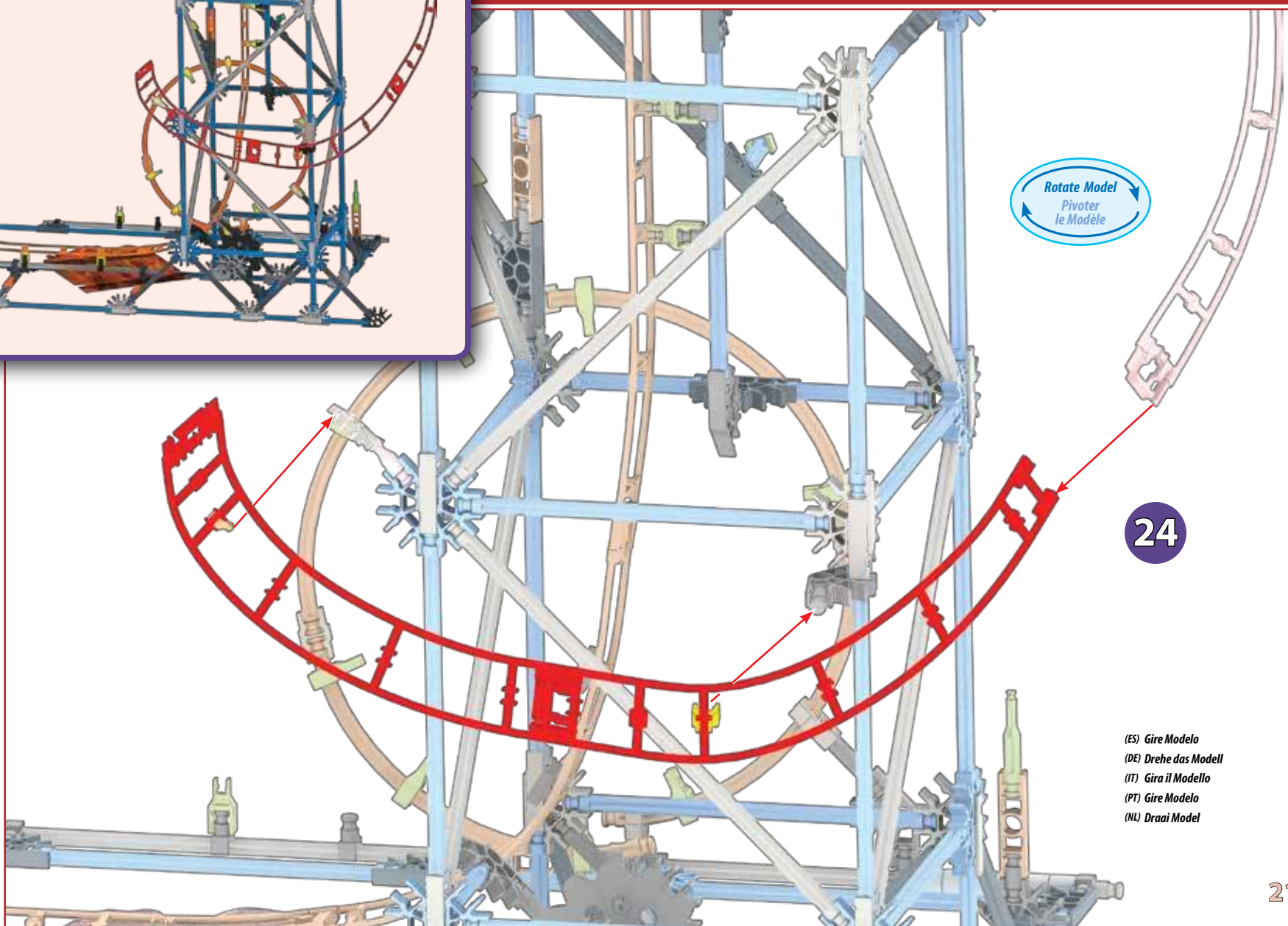

Rotate Model
Pivoter
le Modèle

24

(ES) Gire Modelo
(DE) Drehe das Modell
(IT) Gira il Modello
(PT) Gire Modelo
(NL) Draai Model

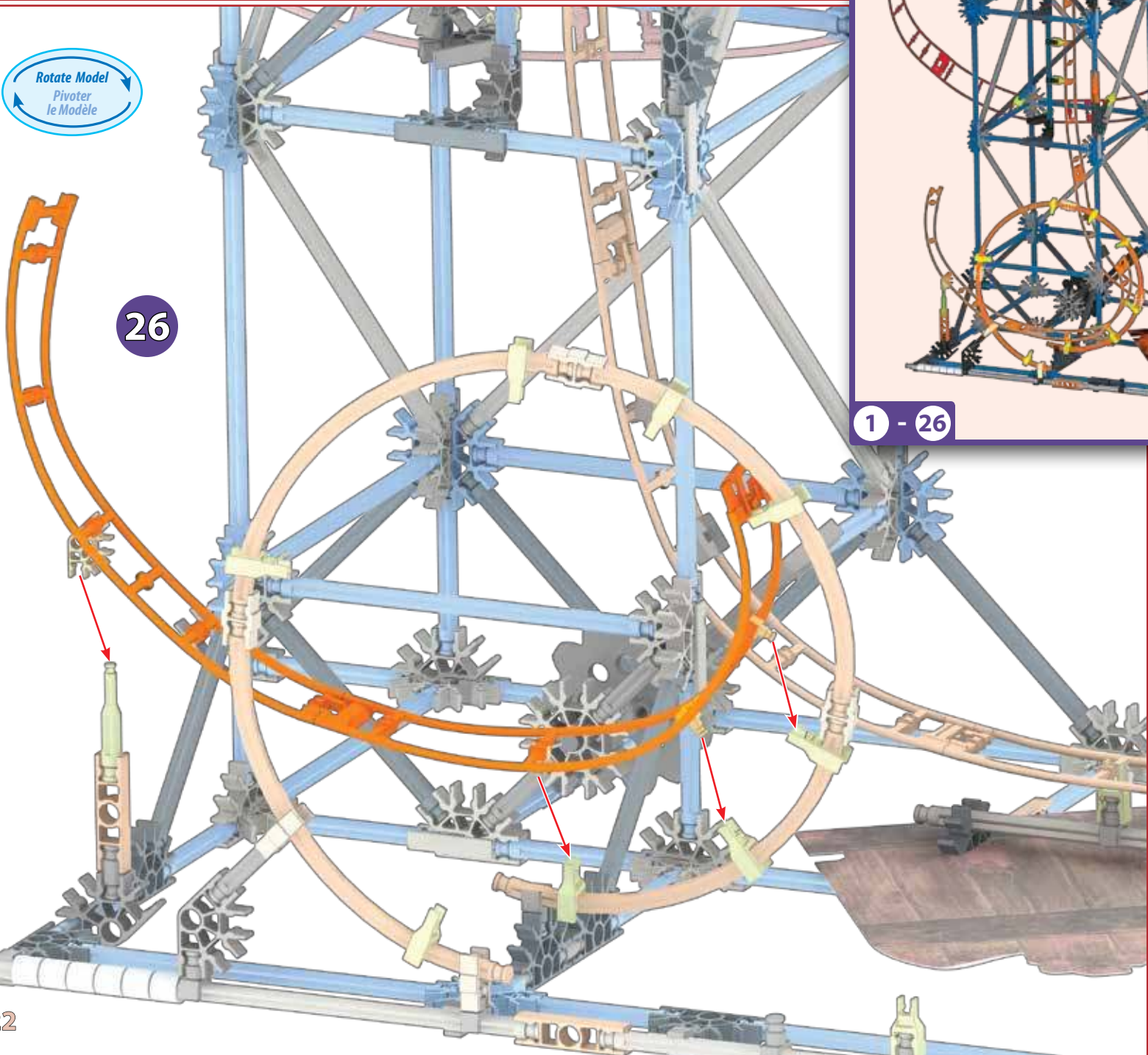
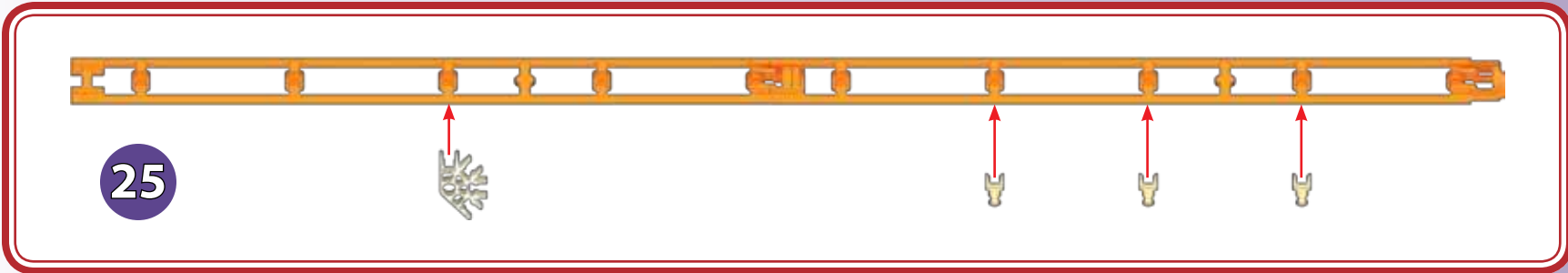

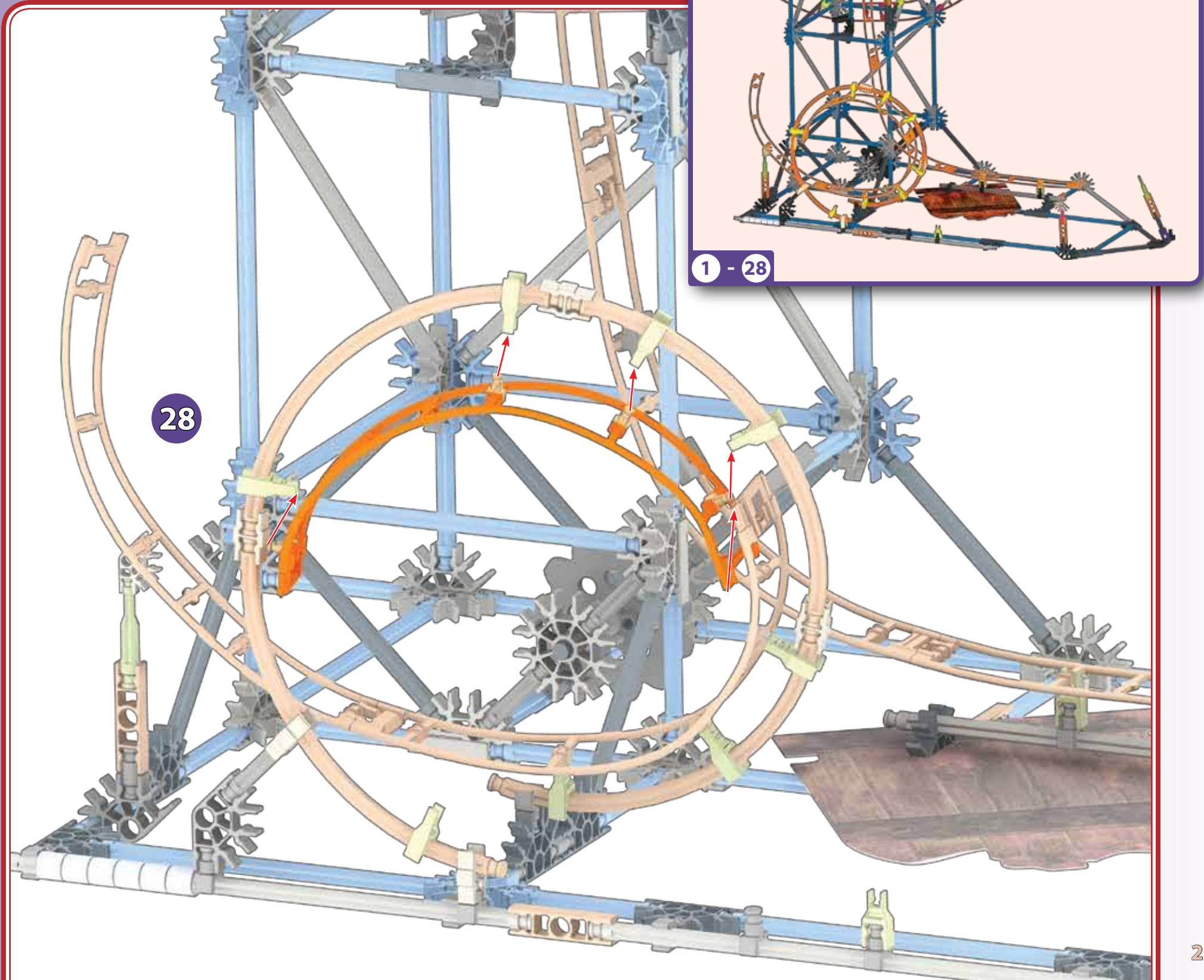
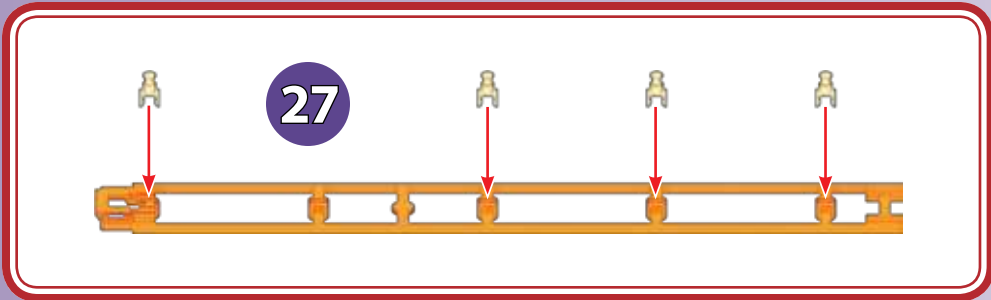

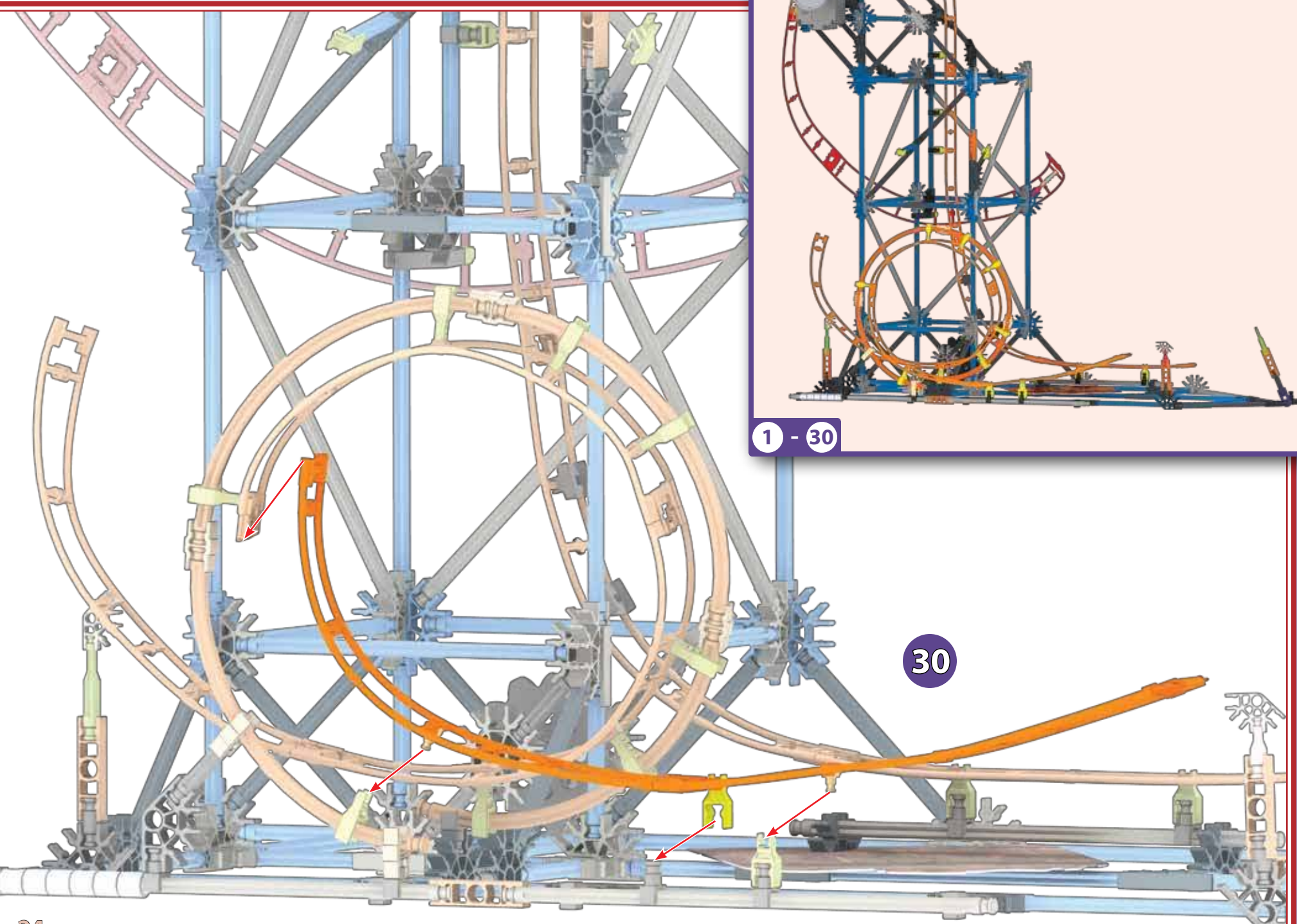
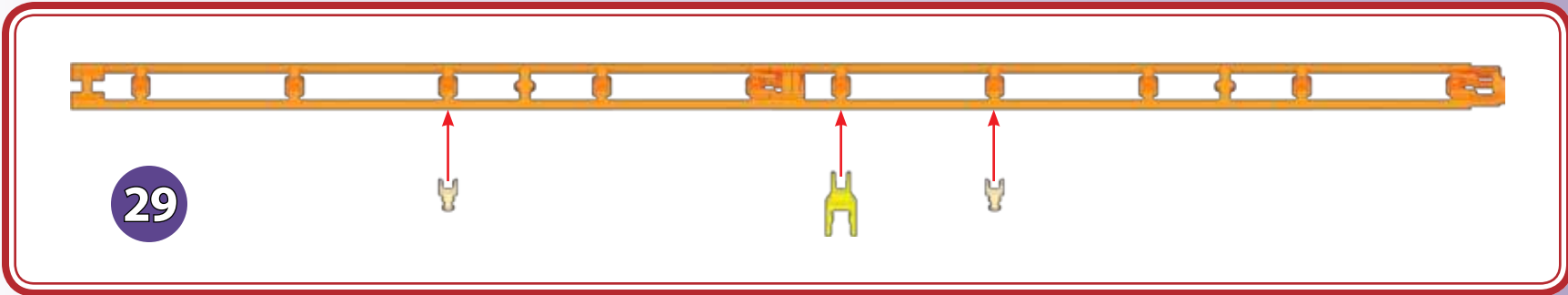

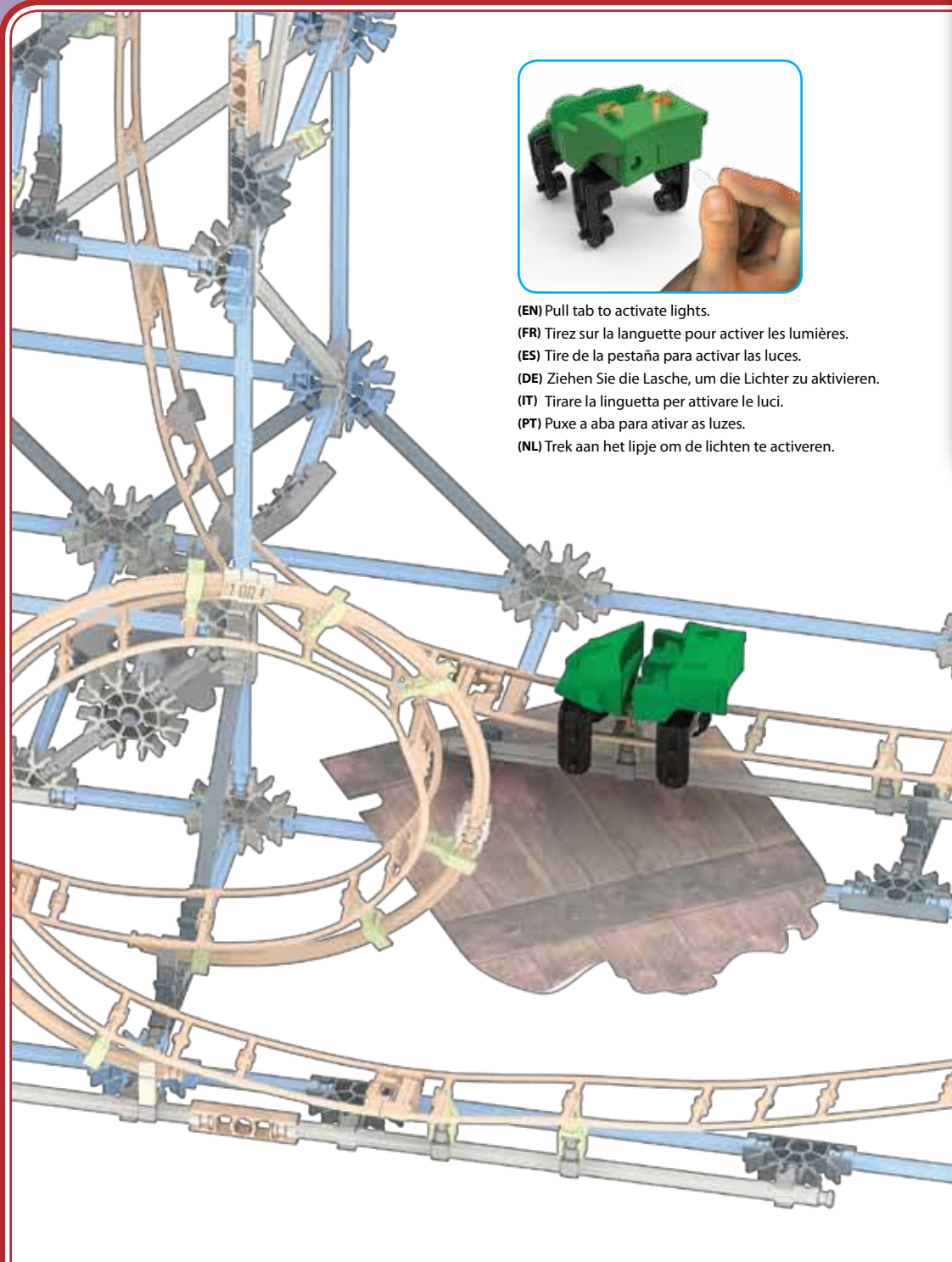
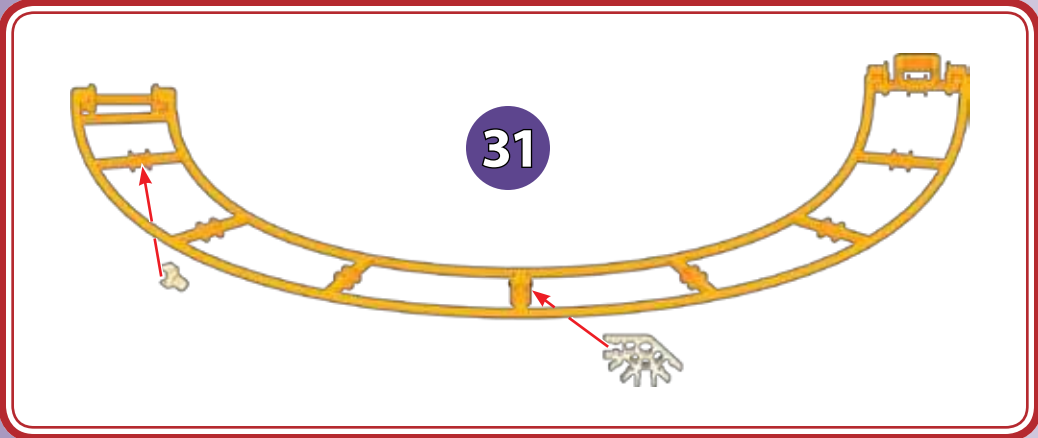

- (EN) Pull tab to activate lights.
- (FR) Tirez sur la languette pour activer les lumières.
- (ES) Tire de la pestaña para activar las luces.
- (DE) Ziehen Sie die Lasche, um die Lichter zu aktivieren.
- (IT) Tirare la linguetta per attivare le luci.
- (PT) Puxe a aba para ativar as luzes.
- (NL) Trek aan het lipje om de lichten te activeren.



1 - 32

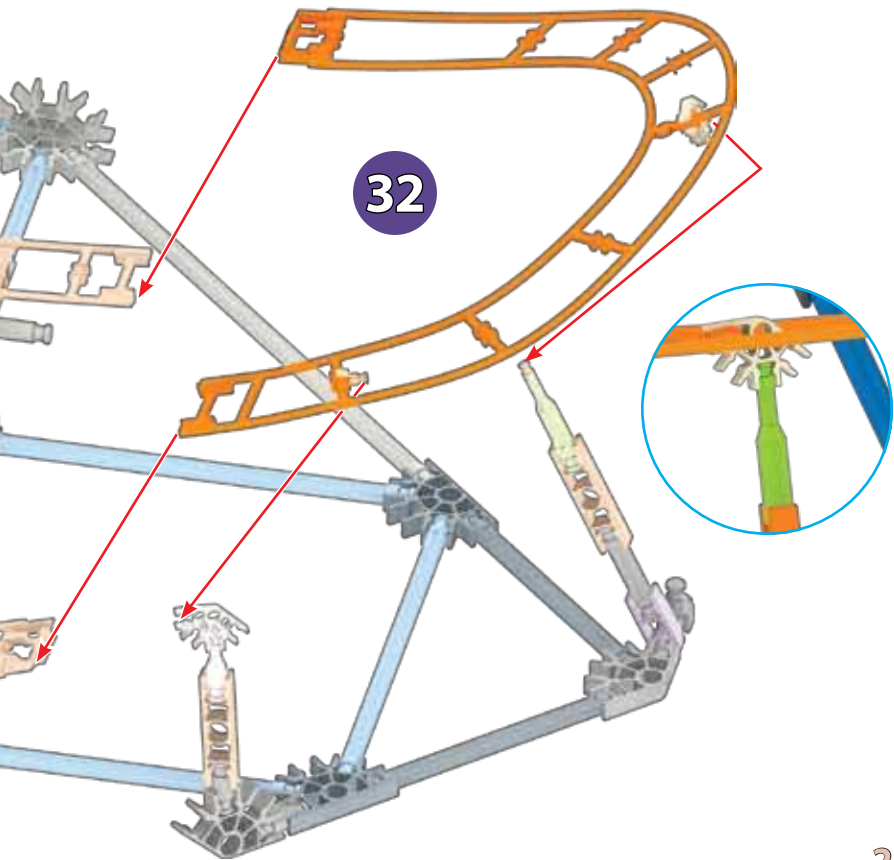



IMPORTANT: Attach all the chain links in the same direction.

IMPORTANT : Assure-toi de fixer tous les maillons de la chaîne dans le même sens.

33



x10

x8

34



x11

x1

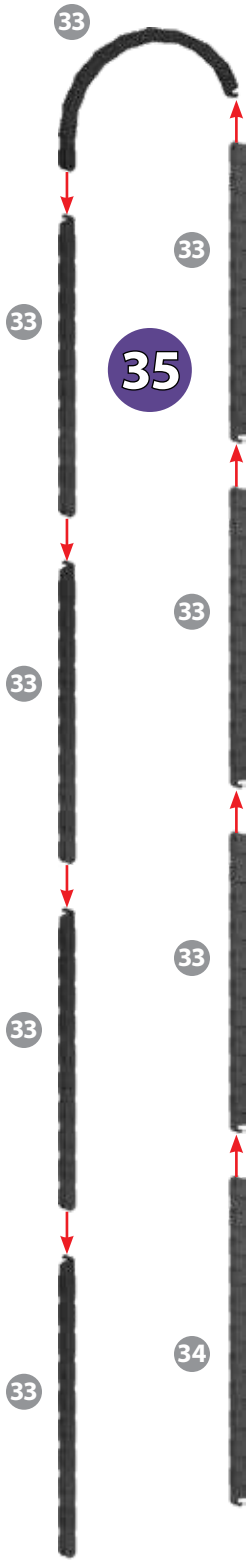

36

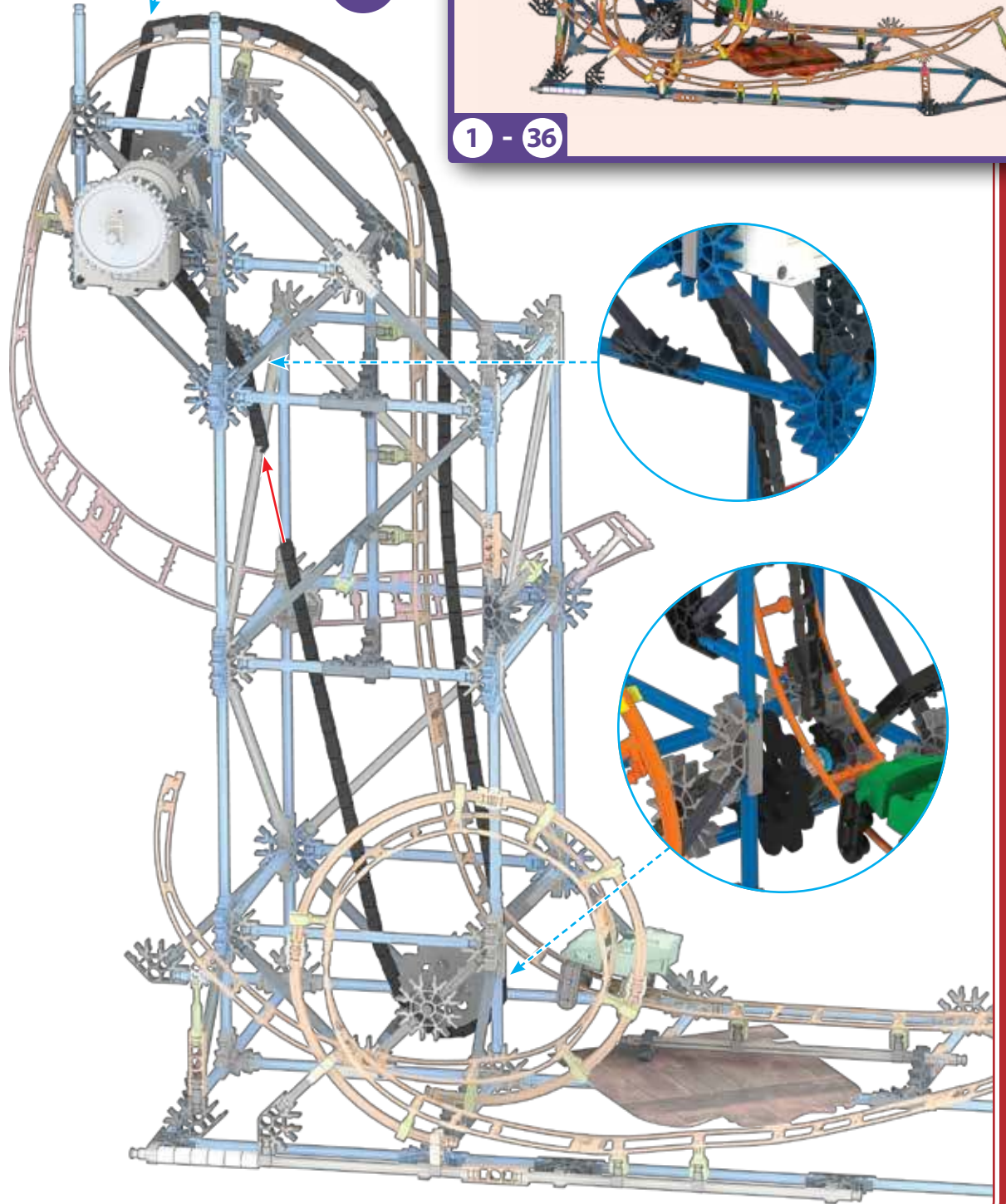

1 - 36

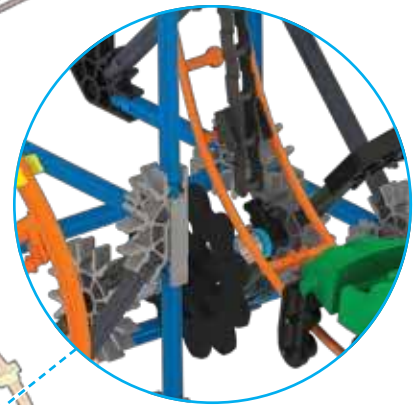
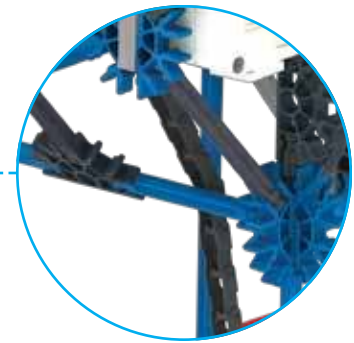



1 - 37

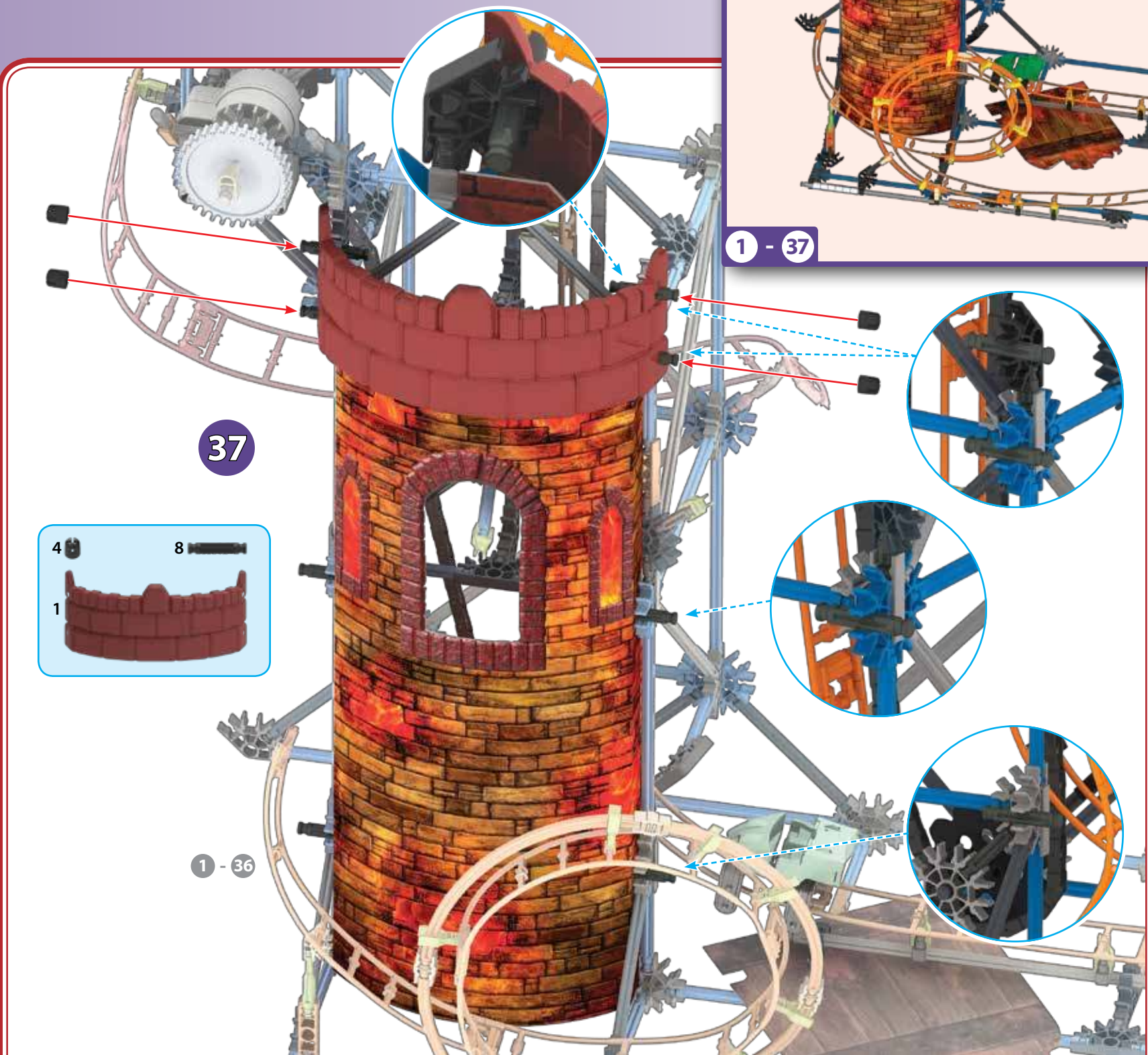

37

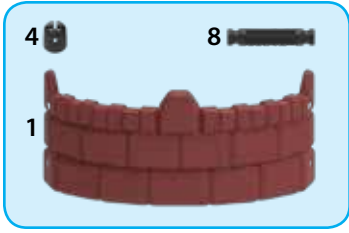

1 - 36

38



39

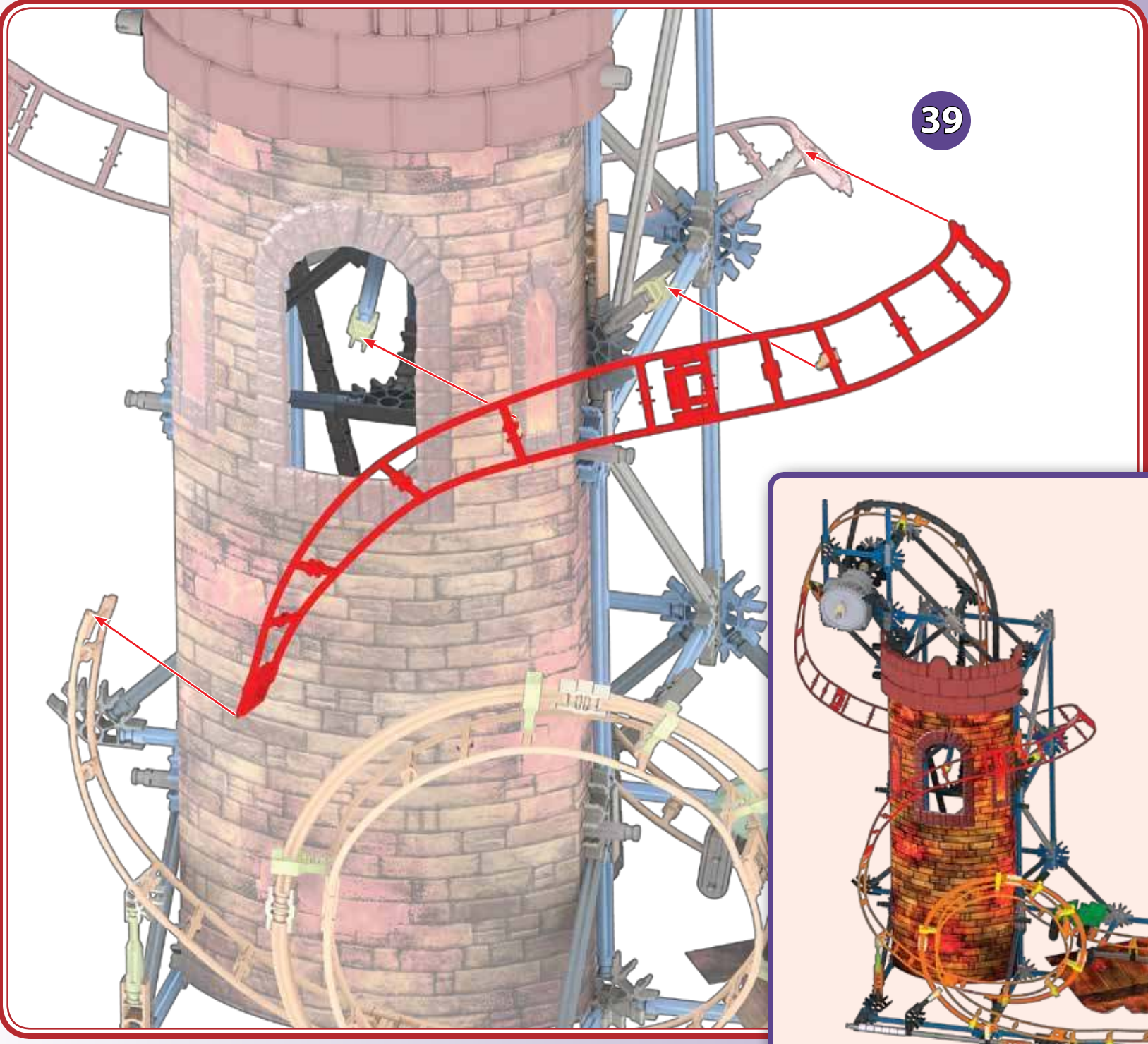

1 - 39

- 2 
- 2 
- 2 
- 4 
- 4 
- 4 

40

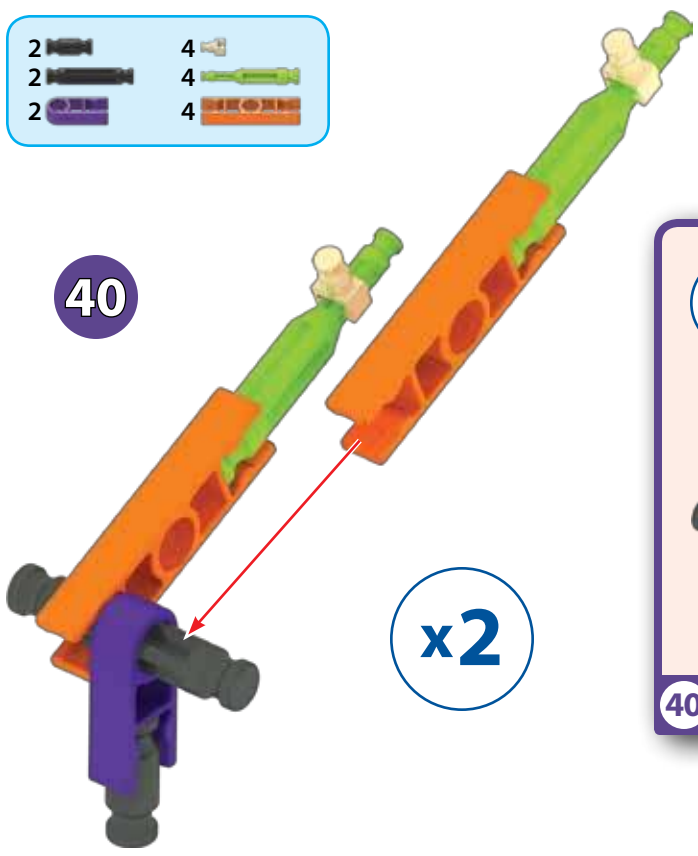

x2



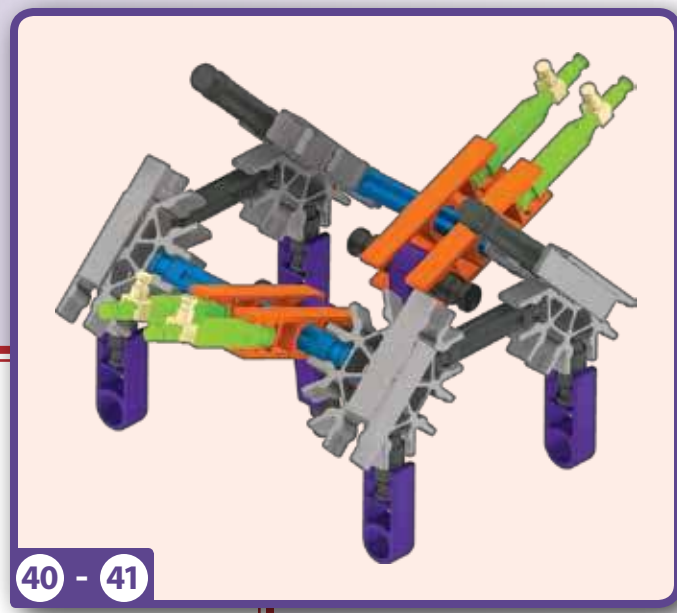
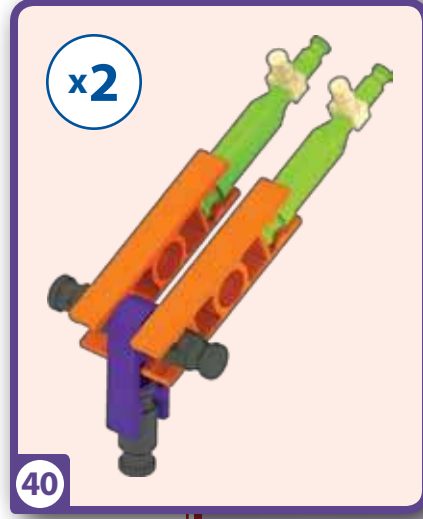

x2

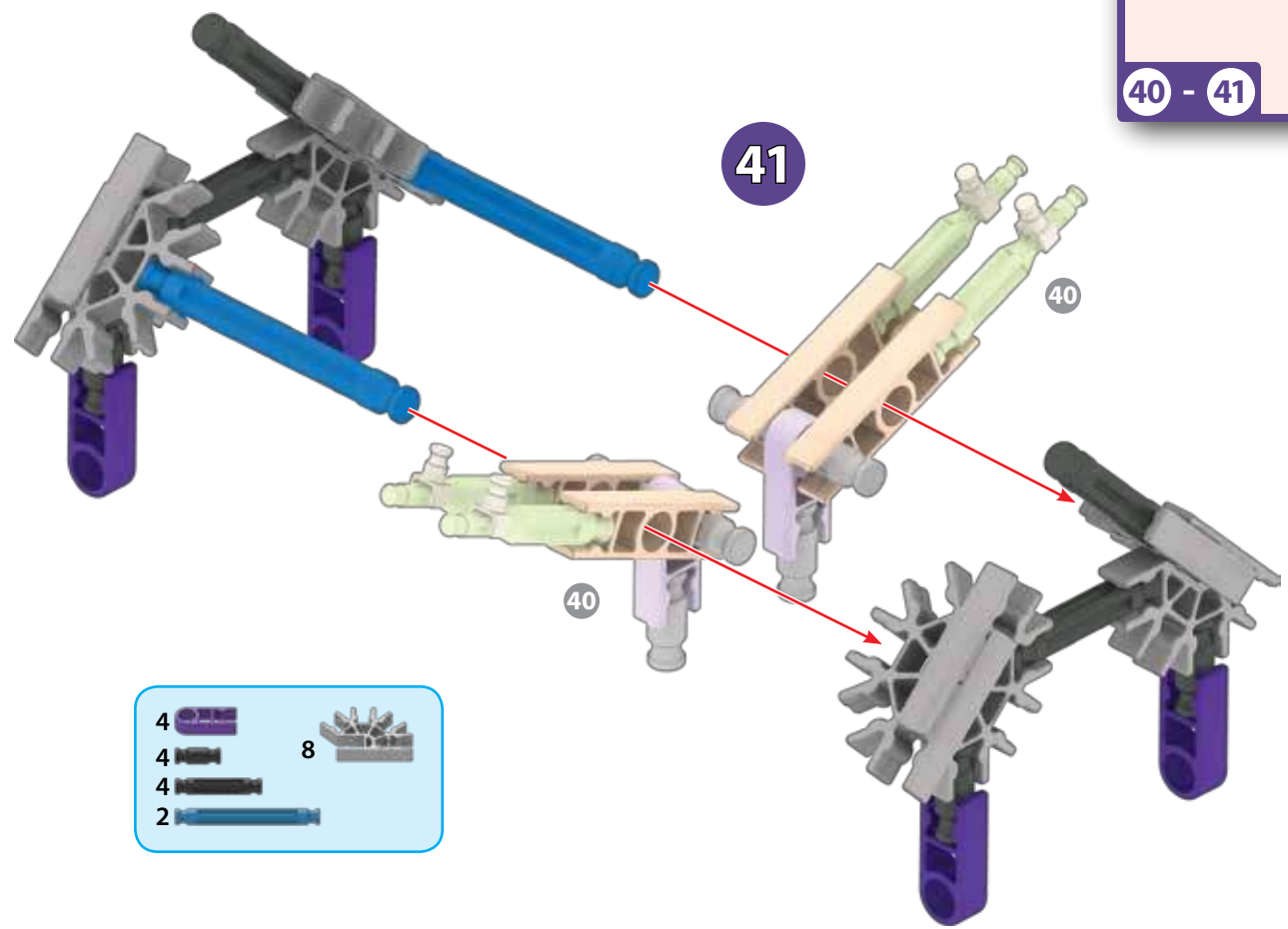

40 - 41

41



- 4 
- 4 
- 4 
- 2 
- 8 





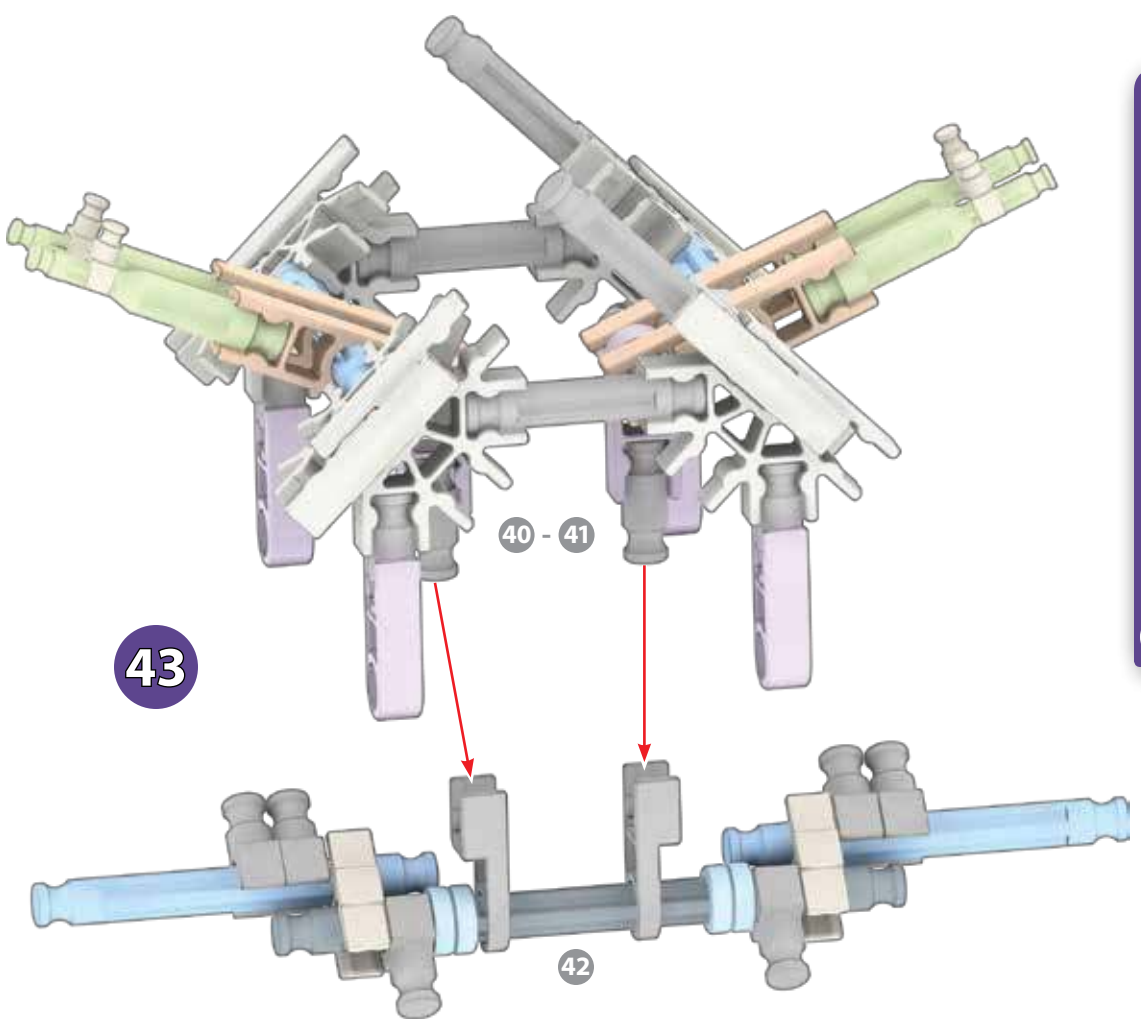
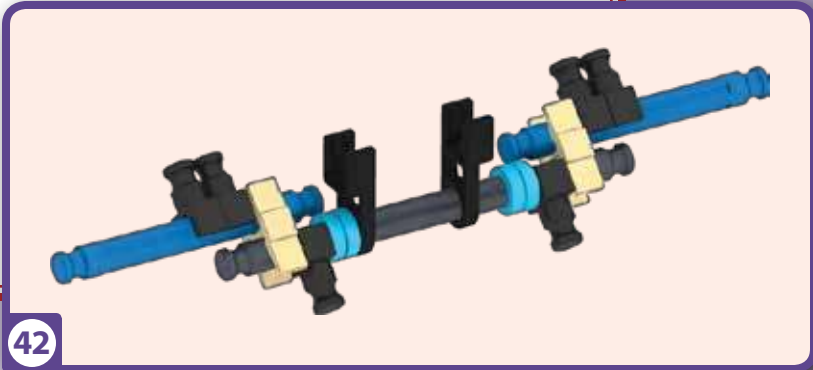
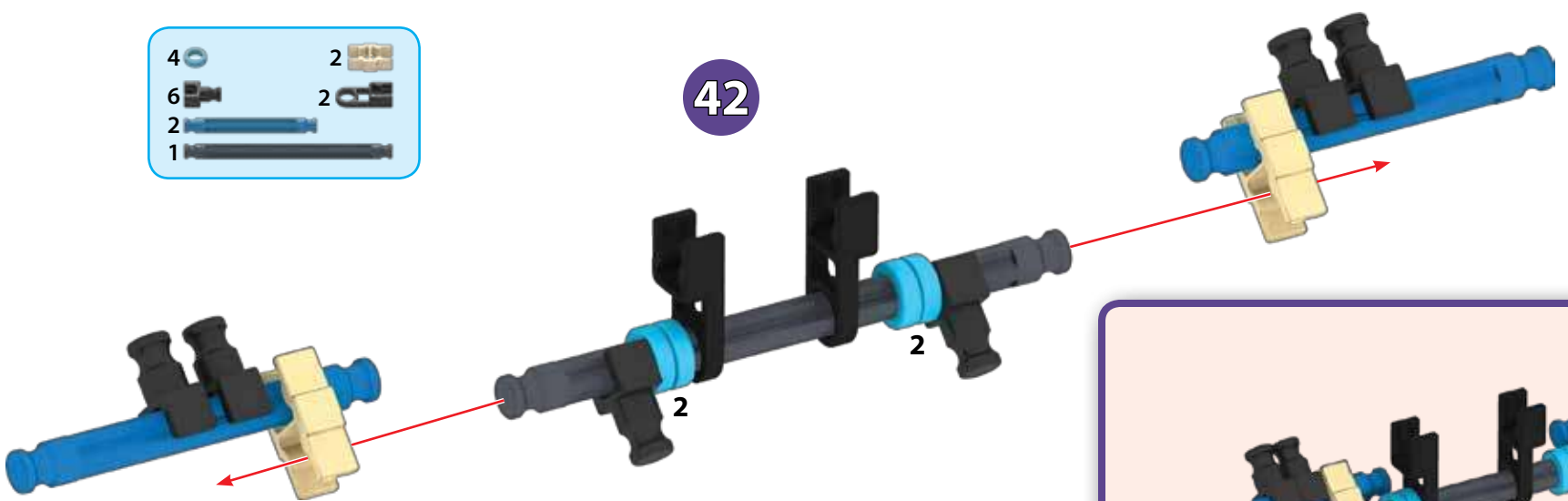

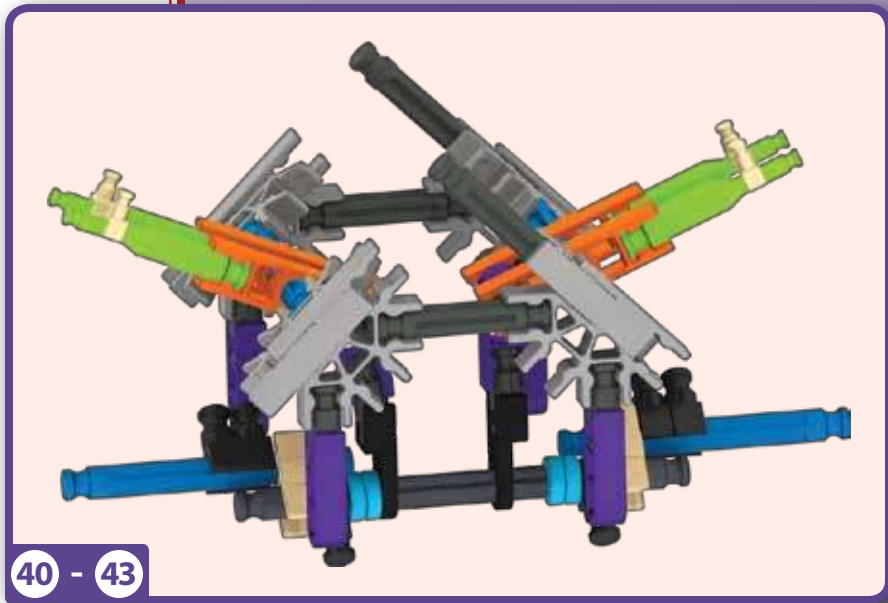

- 4  2 
- 6  2 
- 2  1 
- 1 

42



43



- 2  1  1 
- 4  2  2 
- 1  8 

44

40 - 43

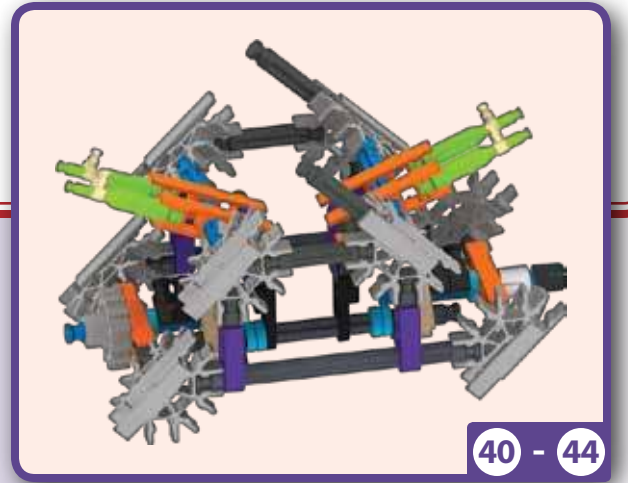
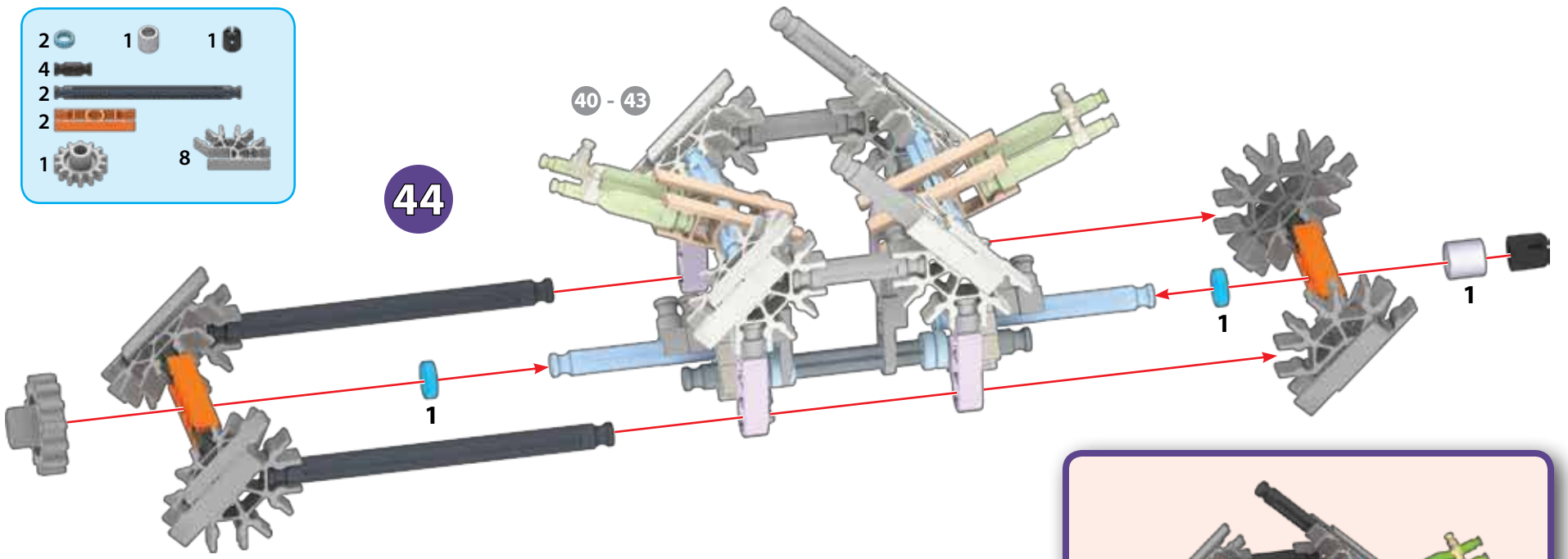

40 - 44

Rotate Model
Pivoter le Modèle

45

40 - 44

1 - 39

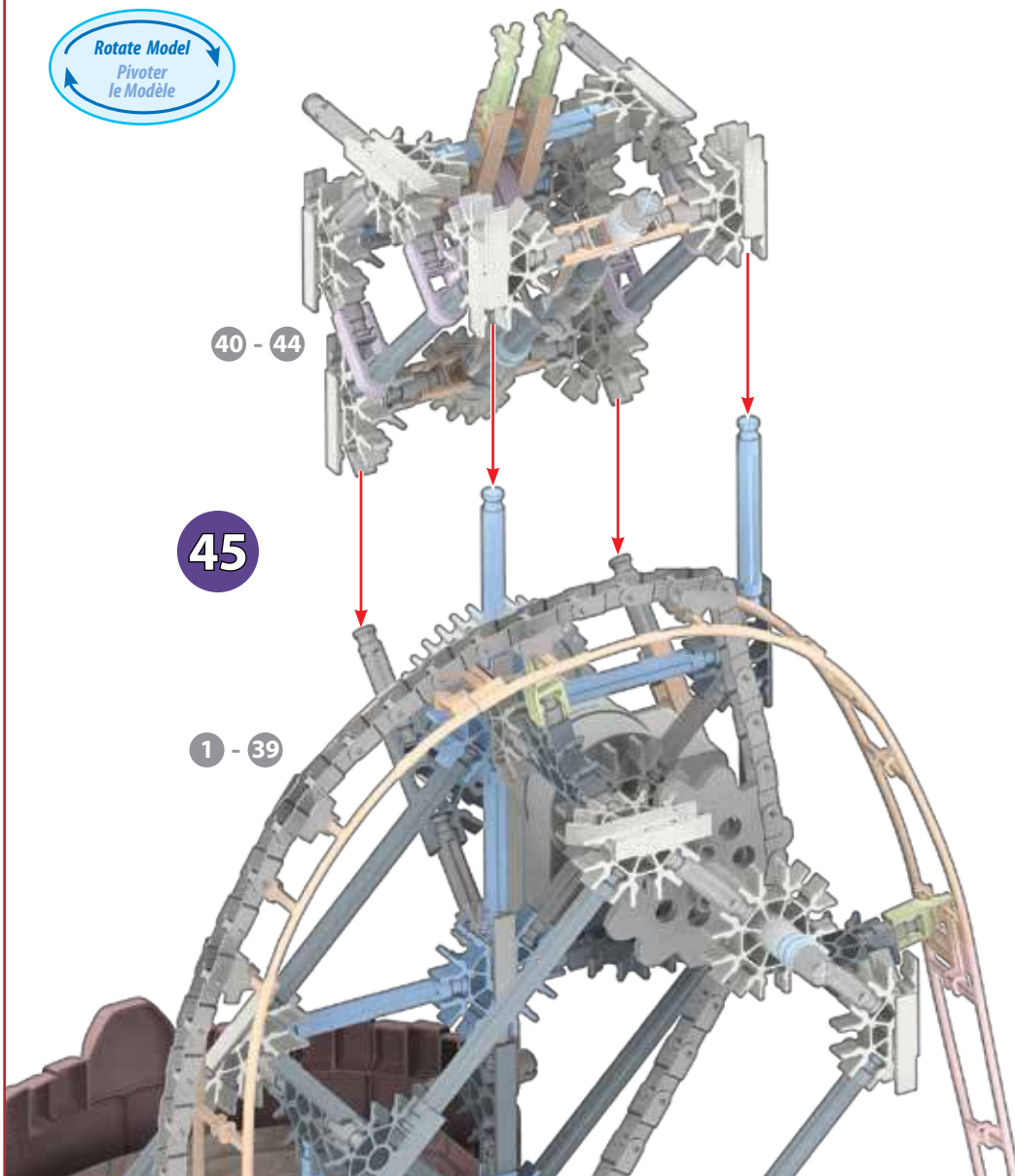

1 - 45

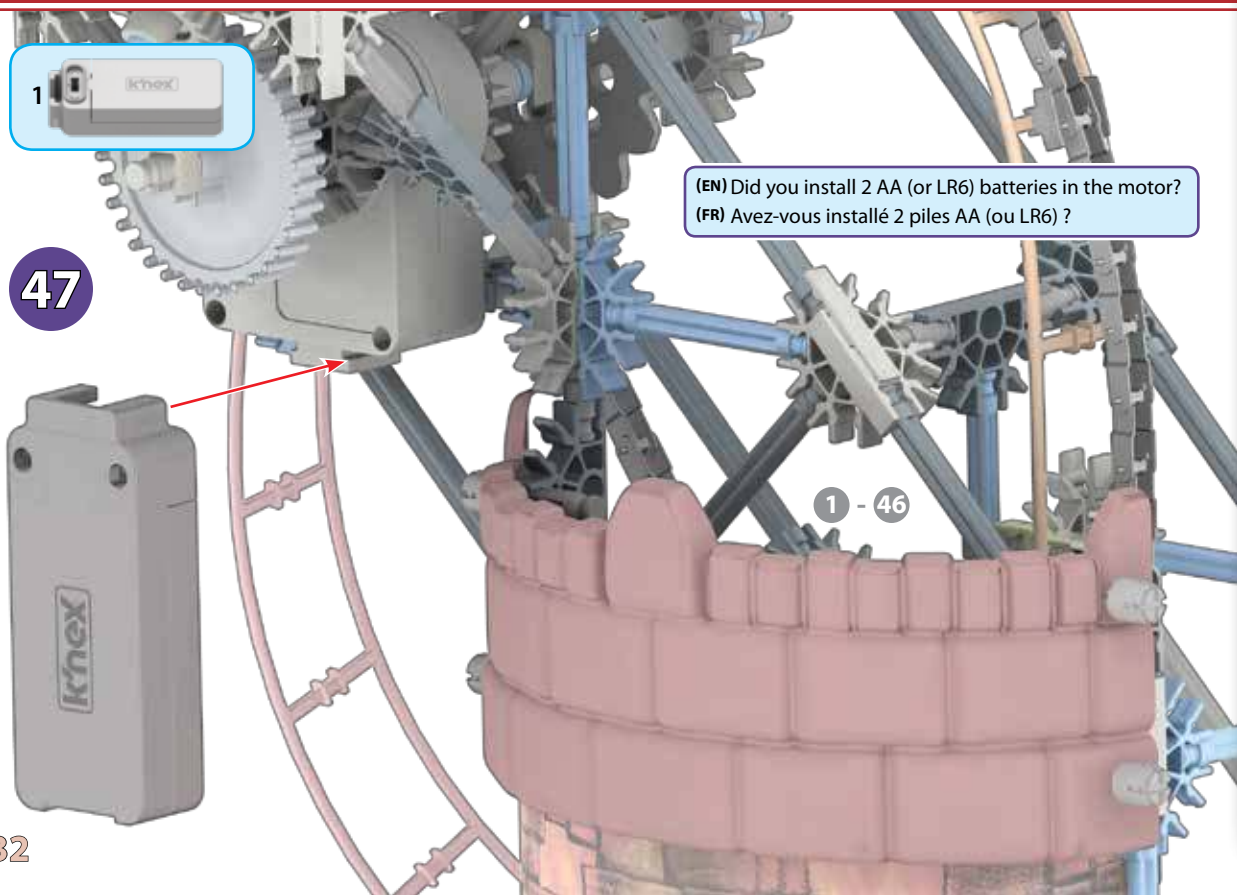

48

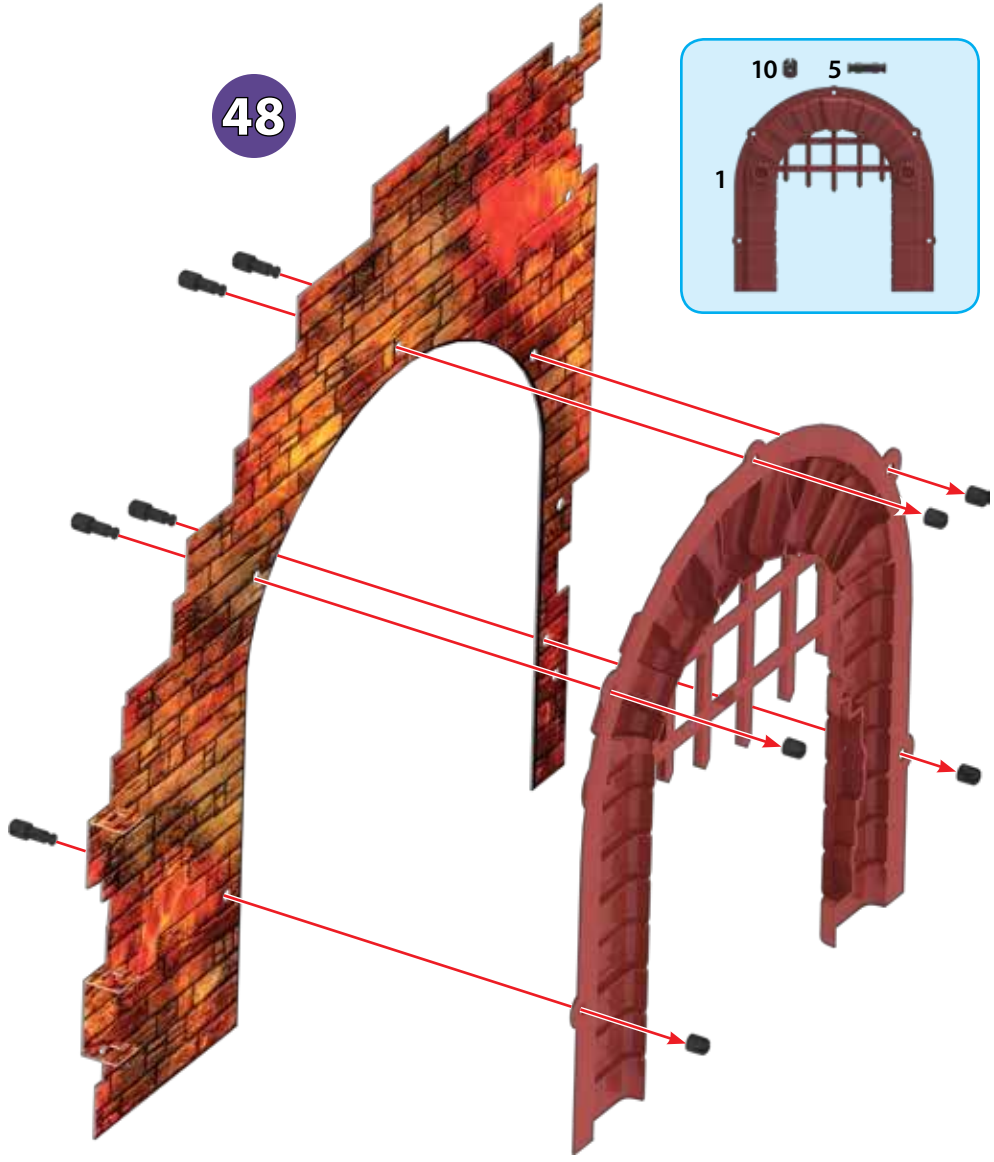
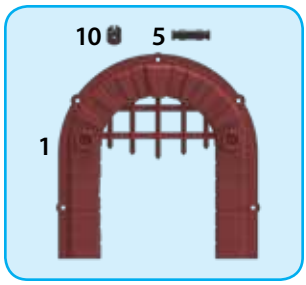

49

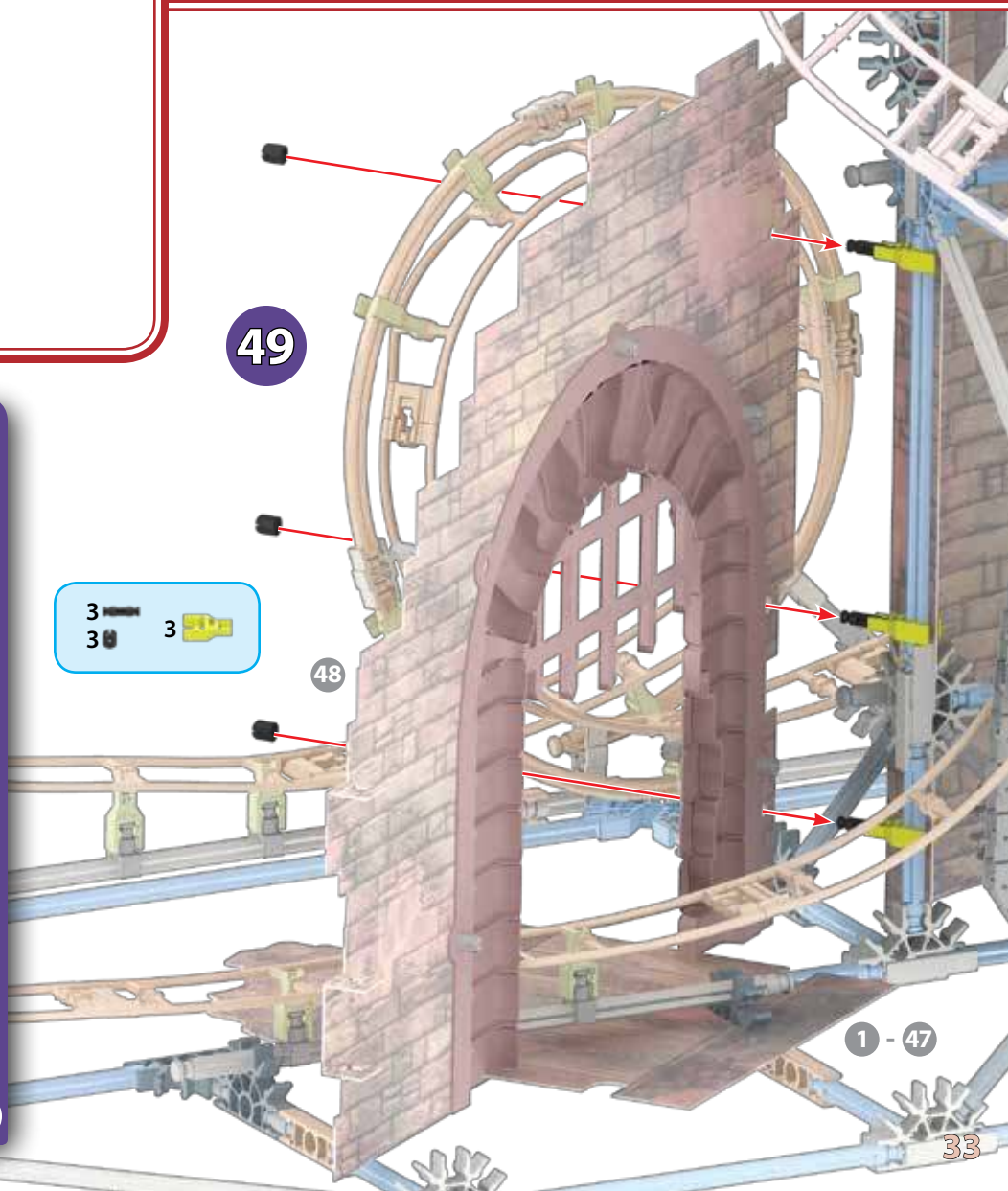
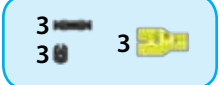

k'nex

Dragon Revenge Roller Coaster

Vengeance du Dragon Montagnes Russes



1 - 50

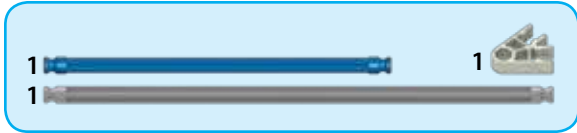

Rotate Model
Pivoter
le Modèle

50



1 - 49

(**ES**) **Español**

(Página 2)

Guarde esta información importante para futuras referencias

⚠ ADVERTENCIA: PELIGRO DE ASFIXIA – Piezas pequeñas. No para niños menores de 3 años. **⚠ ADVERTENCIA:** Este producto contiene un botón o batería de celda de moneda. Un botón ingerido o una batería de celda de moneda puede causar quemaduras químicas internas en tan solo dos horas y causar la muerte. Deseche las baterías usadas inmediatamente. Mantenga las pilas nuevas y usadas fuera del alcance de los niños. Si cree que las baterías podrían haber sido ingeridas o colocadas dentro de cualquier parte del cuerpo, busque atención médica de inmediato.

PRECAUCIÓN: Mantén el cablelo, los dedos, la cara y la ropa alejada de las piezas móviles.

PRECAUCIÓN: Tenga cuidado de no inclinar el modelo. El modelo debe colocarse sobre una superficie plana y dura.

No obstruyas la pista con objetos o cualquier parte de tu cuerpo.

Información de la batería
Cómo insertar y quitar las pilas

MOTOR

Insertar 2 AA (LR6) baterías* frescas en el compartimiento de batería con la polaridad correcta (+/-). * No se incluyen

COCHE

El luz trae 3 pilas, ya instaladas en tu modelo. Para reemplazar las baterías, retire el tornillo. Inserte 3 botones de células (1.55v) (LR41 o AG3) con la polaridad correcta (+/-) como se muestra.

PRECAUCIÓN: Para evitar fugas en las pilas

- Inserte las pilas de acuerdo con los esquemas de polaridad (+/-).
- No mezcle diferentes tipos de pilas.
- No mezcle pilas alcalinas, estándar (carbón-zinc) o recargables.
- No mezcle pilas viejas con nuevas. Se debe usar solamente pilas del mismo tipo, o las que se recomienden como equivalentes.
- Siempre retire las pilas débiles o gastadas del producto; no forme cortocircuito en los puntos de intercambio.
- Retire todas las pilas si el juguete no se usará por mucho tiempo.

Consejos importantes

- Se recomiendan las pilas alcalinas.
- No se recomiendan las pilas recargables.
- Retire las pilas recargables del juguete antes de cargarlas; éstas deben ser cargadas solamente bajo la supervisión de un adulto.
- No se debe recargar las pilas que no son recargables.
- Mantenga los componentes sin polvo; no sumerja ni use en agua.
- No deseche las pilas en el fuego ya que pueden tener fugas, explotar y causar lesiones personales.

⚠

El contenedor de basura indica que este producto no puede desecharse con la basura doméstica debido a la presencia de sustancias peligrosas.

Para proteger la salud humana y el medio ambiente consultar con la agencia local para el consejo y las facilidades de reciclaje (2012/19/EU, solo Europa).

(Página 3)

Básicos de Construcción

Empieza a construir

Cada K'NEX pieza tiene su propia forma y color. Mientras construyes, trata de colocar tu modelo en la misma dirección que se muestra en las instrucciones. Los colores desteñidos muestran que esta sección ya está construida.

Conectores

Usted puede deslizar estos conectores especiales juntos. Empuje firmemente hasta que oiga un “clic”.

Espaciadores

Asegúrese de usar el color correcto y el número de espaciadores que se muestra en las instrucciones.

Cadena

Asegurate de fijar todos los elementos de la cadena en la misma dirección.

(Página 4)

Lista de Piezas

Antes de empezar con la construcción, asegúrate de comparar las piezas en tu conjunto con la lista de las piezas aquí. Si faltan algunas, llámanos o escríbenos siguiendo las instrucciones en la página trasera. Estamos aquí para ayudarte.

(Página 5)

CONSEJOS: Mientras construyes, trata de colocar tu modelo en la misma dirección que se muestra en las instrucciones.

(Página 18)

Sujeta las guías de cadena al lado superior de la pista. Sujeta los conectores en el lado inferior de la pista, exactamente como se muestra. Empuja los conectores hacia adentro hasta que oigas un “clic”.

(Página 19)

Siempre unírese a este extremo de la pista a la pieza primera pista anterior, a continuación, conecte el resto de la pista a la torre.

(Página 26)

¡IMPORTANTE: Asegúrate de fijar todos los elementos de la cadena en la misma dirección.

(Página 32)

¡Instalaste 2 pilas AA (o LR6) en el motor?

(**DE**) **Deutsch**

(Seite 2)

Informationen für später aufbewahren

⚠

ACHTUNG: ERSTICKUNGSGEFAHR – Kleinteile. Nicht geeignet für Kinder unter 3 Jahren. **⚠ ACHTUNG:** Dieses Produkt enthält eine Knopf- oder Knopfzellenbatterie. Ein verschluckter Knopf oder eine Knopfzellenbatterie kann in nur zwei Stunden zu inneren Verbrennungen führen und zum Tod führen. Entsorgen Sie gebrauchte Batterien sofort. Halten Sie neue und gebrauchte Batterien von Kindern fern. Wenn Sie der Meinung sind, dass Batterien verschluckt wurden oder sich in einem Teil des Körpers befinden, suchen Sie sofort einen Arzt auf.

VORSICHT: Haare, Finger, Gesicht und Kleidungsstücke nicht mit beweglichen Teilen in Berührung kommen lassen.

VORSICHT: Sei vorsichtig, das Modell nicht zu betreiben. Das Modell sollte auf eine flache und harte Oberfläche gestellt werden.

Die Schienen dürfen nicht blockiert oder mit dem Körper verdeckt werden.

Informationen zu den Batterien

Anweisungen zum Einlegen und Entfernen der Batterien

MOTOR

Insérer 2 piles AA (LR6)* neues dans le compartiment en respectant a polarité (+/-). * Nicht enthalten

WAGEN

Die Schraube(n) mit einem kleinen Kreuzschraubenzieher lösen. Danach den Deckel des Batteriefachs entfernen und 3 neue Batterien Typ (LR41, AG3) entsprechend der gekennzeichneten Polarität in jedes Fach einlegen.

VORSICHT: Um ein Auslaufen der Batterien zu vermeiden

- Beim Einlegen der Batterien auf die korrekte Polarität (+/-), wie dargestellt, achten.
- Keine Batterien unterschiedlichen Typs mischen.
- Keine alkaline Batterien, Standard-Batterien (Kohle-Zink) od wiederaufladbare Batterien mischen.
- Keine alten und neuen Batterien mischen. Nur Batterien des gleichen Typs oder empfohlenen äquivalenten Typs verwenden.
- Leere oder verbrauchte Batterien aus dem Spielzeug entfernen; darauf achten, dass die Pole der Batterie nicht kurzgeschlossen werden.
- Wenn das Spielzeug längere Zeit nicht verwendet werden soll, alle Batterien entfernen.

Wichtige Tipps

- Alkaline Batterien werden empfohlen.
- Wiederaufladbare Batterien sind nicht empfohlen.
- Bei Verwendung von wiederaufladbaren Batterien müssen diese aus dem Spielzeug entfernt werden, bevor sie wieder aufgeladen werden; das Wiederaufladen darf nur unter Aufsicht eines Erwachsenen stattfinden.
- Nichtwiederaufladbare Batterien dürfen nicht wieder aufgeladen werden.
- Die Komponenten von Staub freihalten; nicht in Wasser tauchen.
- Zu entsorgende Batterien nicht ins Feuer werfen; sie können auslaufen oder explodieren und Körperverletzungen verursachen.

⚠

Der Abfallbehälter zeigt an, dass dieses Produkt aufgrund von Gefahrstoffen nicht im normalen Hausmüll entsorgt werden kann. Zum Schutz von Gesundheit und Umwelt kontaktieren bitte deine lokale Behörden für Recyclingtipps und –einrichtungen (2012/19/EU, nur Europa).

(Seite 3)

Grundlegende Bauanleitungen für K'NEX

Los geht’s mit dem Bauen

Jedes K'NEX Teil hat seine eigene Form und Farbe. Versuche, dein Modell beim Zusammenbauen so zu orientieren, dass es in die gleiche Richtung weist, wie es in den Anleitungen beschrieben und gezeigt wird. Blassé Farben weisen darauf hin, dass dieser Streckenabschnitt bereits zusammengebaut ist.

Verbindungsstücke

Verbindungsstücke haben besonders lange Schlitzte. Achte beim Aneinanderfügen dieser Teile darauf, dass du ein Klickgeräusch hörst.

Abstandsstücke

Achte darauf, die richtige Farbe und Anzahl von Abstandsstücken wie in der Anleitung gezeigt zu verwenden.

Kette

Achte darauf, alle Kettenglieder in der gleichen Richtung zu verbinden.

(Seite 5)

Teileliste

Bevor du mit dem Bauen anfängst, solltest du prüfen ob die Teile in deinem Bausatz mit denen auf dieser Teilleiste übereinstimmen. Falls etwas fehlt, rufe uns an oder schreibe uns (siehe Rückseite). Wir sind für dich da!

(Seite 5)

TIPP: Versuche, dein Modell beim Zusammenbauen so zu orientieren, dass es in die gleiche Richtung weist, wie es in den Anleitungen beschrieben und gezeigt wird.

(Seite 18)

Maak de kettinggidsen vast bovenaan het spoor. Maak de koppelstukken vast aan de onderkant van het spoor precies zoals afgebeeld.

Druk de koppelstukken goed erin tot ze “klikken”.

(Seite 19)

Immer beitreten dieses Ende der Strecke zum vorherigen Track Stück zuerst, dann treten der Rest der Strecke auf den Turn.

(Seite 26)

WICHTIGE: Achte darauf, alle Kettenglieder in der gleichen Richtung zu verbinden.

(Seite 32)

Hast du 2 AA (oder LR6) Batterien in den Motor eingelegt?

(**IT**) **Italiano**

(Página 2)

Conservare queste importanti informazioni per riferimento futuro

⚠

AVVISO: PERICOLO DI SOFFOCARE – Pezzi piccoli. Non adatto per bambini sotto 3 anni. **AVVISO:** Questo prodotto contiene una batteria a bottone o a bottone. Una batteria pulsante o a moneta ingerita può causare ustioni chimiche interne in appena due ore e portare a morte. Smaltire immediatamente le batterie usate. Tenere le batterie nuove e usate lontano dalla portata dei bambini. Se si ritiene che le batterie potrebbero essere state ingerite o posizionate all'interno di una parte del corpo, rivolgersi immediatamente a un medico.

ATTENZIONE: Tenere i capelli, le dita, il viso e i vestiti lontano da tutte le parti in movimento. **ATTENZIONE:** Fare attenzione a non inclinare il modello sopra. Modello deve essere collocato su una superficie piana e dura.

Non ostruire la pista con gli oggetti o qualsiasi parte del vostro corpo.

Informazioni sulle batterie

Come inserire e rimuovere le batterie

MOTORE

Inserire 2 AA (o LR6) batterie* fresche nello scompartimento di batteria con la polarità corretta (+/-). * Non incluse

MACCHINA

Usare un piccolo giravite a stella per allentare la vite e quindi rimuovere lo sportello delle batterie. Inserire 3 batterie a bottone nuove (LR41, AG3) nell'alloggiamento delle batterie con la polarità corretta (+/-).

ATTENZIONE: Come evitare perdite delle batterie

- Inserire le batterie con la polarità corretta (+/-) come illustrato.
- Non mischiare tipi diversi di batterie.
- Non mischiare alcaline, standard (carbonio-zinco) e ricaricabili.
- Non mischiare insieme batterie nuove e vecchie. Usare sempre batterie raccomandate dello stesso tipo o di tipo equivalente.
- Rimuovere sempre batterie quasi scariche o completamente scariche dal prodotto; non causare corto circuito ai terminali di alimentazione.
- Non gettare le batterie nel fuoco, poiché potrebbero perdere o esplodere e causare lesioni.

Consigli importanti

- Si raccomanda l'uso di batterie alcaline.
- Non si raccomanda l'uso di batterie ricaricabili.
- Rimuovere le batterie ricaricabili dal giocattolo prima della carica: devono essere caricate solo sotto la supervisione di un adulto.
- Le batterie non ricaricabili non devono essere ricaricate.
- Mantenerne i componenti privi di polvere; non immergere o usare in acqua.
- Rimuovere tutte le batterie se il giocattolo non verrà usato per un lungo periodo di tempo.

⚠

Il bidone della spazzatura indica che questo prodotto non si può buttare via con i rifiuti domestici a causa della presenza di sostanze pericolose.

Per proteggere la salute umana e l'ambiente, devi controllare con la tua autorità locale per consigli e impianti di riciclaggio (2012/19/EU, solo in Europa).

(Página 3)

Istruzioni di base per costruire con K'NEX

Comincia a costruire

Ogni K'NEX pezzo ha una sua forma e un suo colore. Cerca di tenere il modello nella stessa direzione della figura e in tal modo sarà più semplice allegare i pezzi nei posti giusti. I colori spenti ti dicono che questa sezione è già stata costruita.

Connettori

È molto importante posizionare i connettori in una specifica direzione. Spingi con forza fino ad udire un clic.

Spaziatori

Accertati che usate il colore corretto e il numero di spaziatori mostrati nel’ istruzioni.

Catena

Accertati di attaccare tutti i collegamenti della catena nella stessa direzione.

(Página 4)

Elenco delle parti

Prima di cominciare a costruire, accertati di confrontare le parti che sono nel tuo set con l'elenco delle parti qui. Se ne manca una chiamaci o scrivi usando le informazioni che sono nella retrocopertina. Noi siamo qui per aiutariti!

(Página 5)

SUGGERIMENTI: Orienta il tuo modello nella stessa direzione indicata nelle istruzioni.

(Página 18)

Attaca le guide a catena sulla parte superiore della rotaia. Collega i connettori sulla base della rotaia esattamente come illustrato.

Premi i connettori saldamente fino a che si fissano con uno scatto.

(Página 19)

Sempre participare a questo fine della traccia per traccia del pezzo precedente, poi collegare il resto della pista alla torre.

(Página 26)

¡IMPORTANTI: Accertati di attaccare tutti i collegamenti della catena nella stessa direzione.

(Página 32)

Hai installato 2 batterie AA (o LR6) nel motore?

(**PT**) **Português**

(Página 2)

Manter esta informação importante para referência futura

⚠

AVISO: PERIGO DE SUFOCAÇÃO – Peças pequenas. Não se destina a crianças com menos de 3 anos de idade.

AVISO: Este produto contém um botão o uma bateria de célula tipo moeda. Um botão o bateria de célula tipo moeda engolidos podem causar quemaduras químicas internas em apenas duas horas e levar a morte. Descarte as baterias usadas imediatamente. Mantenha as baterias novas e usadas longe das crianças. Se você acha que as baterias podem ter sido engolidas ou colocadas dentro de qualquer parte do corpo, procure imediatamente atendimento médico.

UIDADO: Mantém o cabelo, os dedos, a cara e a roupa afastados de todas as peças móveis.

CUIDADO: Tenha cuidado para não derrubar o modelo. O modelo deve ser colocado sobre uma superfície plana e dura.

Não obstruir a trilha com objetos ou qualquer parte de seu corpo.

Informações sobre as pilhas

Como introduzir e remover baterias

MOTOR

Usar uma chave de fenda principal pequena de Phillips para afrouxar o parafuso e para remover a tampa de bateria. Introduzir 2 AA (ou LR6) baterias* frescas no compartimento de bateria com a polaridade correta (+/-). * Não estão incluídas

CARRO

Use uma pequena chave de parafusos de cabeça Phillips para soltar o parafuso e retirar a porta do compartimento da pilha. Introduza 3 pilhas de célula tipo relógio novas (LR41, AG3) em cada divisória, posicionadas com a polaridade correta (+/-).

UIDADO: Para evitar fugas das pilhas

- Introduza as pilhas com a polaridade correta (+/-), conforme se mostra.
- Não misture tipos diferentes de pilhas.
- Não misture pilhas alcalinas, padrão (carbono-zinco) ou pilhas recarregáveis.
- Não combine pilhas usadas com pilhas novas. Apenas pilhas do mesmo tipo ou equivalentes ao tipo recomendado.
- Retire sempre as pilhas fracas ou gastas do produto; não provoque um curto-circuito nos terminais de alimentação.
- Retire todas as pilhas do brinquedo se não tencionar usá-lo durante um longo período de tempo.

Conselhos importantes

- Recomenda se o uso de pilhas alcalinas.
- Não se recomenda o uso de pilhas recarregáveis.
- Retire as pilhas recarregáveis do brinquedo antes de as carregar; estas pilhas devem ser recarregadas apenas sob vigilância de adultos.
- As pilhas não recarregáveis não devem ser carregadas.
- Mantenha os componentes livres de poeira; não mergulhe em água nem use água.
- Não elimine as pilhas queimando-as; estas podem apresentar fumaça ou explodir causando lesões.

⚠

O caixote do lixo indica que este produto não pode ser descartado junto com o lixo doméstico devido à presença de substâncias perigosas.

Para proteger a saúde humana e o meio ambiente verifique a sua autoridade local para reciclagem conselho e instalações (2012/19/EU, somente na Europa).

(Página 3)

Pontos básicos para a construção K'NEX
Inicia a construção

Cada K'NEX peça tem a sua própria forma definida e cor. Enquanto estás a montar as peças, tenta manter o teu modelo na mesma direcção, conforme mostrado na ilustração, para assim conectar as peças correctamente. As cores desbotadas indicam que esta secção já está construído.

Conectores

Empurre estes conectores especiais juntos firmemente até ouvir um “clique”.

Espaçadores

Instala certos pontos no teu modelo que necessitam a colocação de espaçadores. Certifique-se de contar com cuidado.

Correte

Assegura-te que prendes todos os elos da corrente seguindo a mesma direcção.

(Página 4)

Lista de peças

Antes de iniciaras a construção, certifica-te de que comparas as peças do teu conjunto com a lista das peças aqui. Se faltar alguma peça telefona ou escreve-nos usando as informações indicadas na contracapa. Estamos aqui para te ajudar!

(Página 5)

SUGESTÕES: Tenta fazer com que o teu modelo esteja virado exactamente na mesma direcção indicada nas instruções.

(Página 18)

Prende as Guias de Corrente ao topo da Pista. Liga os conectores à base da Pista exactamente como demonstrado.

Faz avançar os conectores firmemente até “encaixarem” com um estalido.

(Página 19)

Sempre aderir a este final da trilha para a peça faixa anterior primeiro, e depois conectar o restante da trilha para a torre.

(Página 26)

¡IMPORTANTES: Assegura-te que prendes todos os elos da corrente seguindo a mesma direcção.

(Página 32)

Foram instaladas as pilhas 2 AA (ou LR6) no motor?

(**NL**) **Nederlands**

(Bladzijde 2)

Bewaar deze belangrijke informatie, zodat u deze in de toekomst opnieuw kunt raadplegen

⚠

WAARSCHUWING: VERSTIKKINGSGEVAAR - Kleine onderdelen. Niet geschikt voor kinderen jonger dan 3 jaar.

WAARSCHUWING: Dit product bevat een knoopcel- of knoopcelbatterij. Een ingeslikte knop of knoopcelbatterij kan binnen twee uur interne chemische brandwonden veroorzaken en tot de dood leiden. Gooi gebruikte batterijen onmiddellijk weg. Houd nieuwe en gebruikte batterijen uit de buurt van kinderen. Als u denkt dat batterijen zijn ingeslikt of in een deel van het lichaam zijn geplaatst, dient u onmiddellijk medische hulp in te roepen.

OPGEPAST: Houd handen, haar, gezicht en kleding uit de buurt van bewegende onderdelen.

OPGEPAST: Zorg ervoor dat het model niet te kantelen. Model moet op een vlak en hard oppervlak geplaatst.

Het spoor niet versperren met objecten of met een deel van je lichaam.

Informatie over Batterijen

Batterijen plaatsen en verwijderen

MOTOR

Plaats 2 nieuwe AA-batterijen* (LR6) in het batterijvak en let daarbij op de polariteit (+/-), zoals hier wordt getoond. *Niet inbegrepen

AUTO

Avänd en liten Phillips-skruvmejsel för att lossa skruven. Sätt i 3 nya batterier (LR41, AG3) i utrymmet med rätt polaritet enligt vidstående figur.

WAARSCHUWING: Voorkom lekende batterijen

- Let op de polariteit bij het plaatsen van batterijen (+/-), zoals wordt getoond.
- Gebruik geen verschillende typen batterijen samen.
- Gebruik geen alkaline, gewone (koolstof-zink) of oplaadbare batterijen samen.
- Gebruik geen nieuwe en gebruikte batterijen samen. Gebruik uitsluitend batterijen van het aanbevolen type of van een gelijkwaardig type.
- Verwijder lege batterijen uit het speelgoed. Vermijd kortsluiting.
- Verwijder de batterijen uit het speelgoed als het langere tijd niet wordt gebruikt.

Belangrijke tips

- Alkalinebatterijen worden aanbevolen.
- Oplaadbare batterijen worden niet aanbevolen.
- Verwijder oplaadbare batterijen voordat u ze oplaadt. Het opladen mag uitsluitend gebeuren onder toezicht van een volwassene.
- Niet-oplaadbare batterijen mogen niet worden opgeladen.
- Houd de onderdelen stofvrij. Niet in water dompelen of gebruiken.
- Gooi batterijen niet in het vuur. Ze kunnen lekken of exploderen en schade veroorzaken.

⚠

Het pictogram van een verwijzbare vuilnisbak geeft weer dat dit product niet samen met het gewone huis-, tuin- en keukenafval mag worden weggegooid, omdat het gevaarlijke substanties bevat.

Bescherm gezondheid en milieu en vraag advies aan de plaatselijke afvalverwerkingsdienst over hoe en waar u producten kunt recyclen (201

K'NEX

knex.com

@knex

facebook.com/knex

Dragon Revenge Roller Coaster Building Set

Vengeance du Dragon Montagnes Russes Jeu de construction

Venganza del Dragón Montaña Rusa Juego De Construcción



(EN) Product & colors may vary.

(FR) Le produit et ses couleurs peuvent varier.

(ES) El producto y los colores pueden variar.

(DE) Produkte und Farben können abweichen.

(IT) Prodotti e colori possono differire.

(PT) O produto e as cores podem variar.

(NL) Product en kleuren kunnen variëren.

©2019 K'NEX, a Division of Basic Fun, Inc., P.O. Box 700, Hatfield, PA 19440-0700; 1-800-KID-KNEX (USA/Canada/États-Unis/EE.UU.); email@knex.com; knex.com. K'NEX UK Ltd., 200 Brook Drive, Green Park, Reading, RG6 2UB England; K'NEX France, 24 rue du Quatre Septembre, 75002 Paris, France.

(EN) K'NEX is a registered trademark of Basic Fun, Inc. For customers outside the USA/Canada please contact your local distributor at www.knex.com/distributors

(FR) K'NEX est une marque déposée de Basic Fun, Inc. Pour les clients en dehors du Canada et des États-Unis, veuillez contacter votre distributeur local que vous pouvez trouver sur www.knex.com/distributeur

(ES) K'NEX es una marca registrada de Basic Fun, Inc. Para clientes fuera de los EE.UU. y Canadá, por favor póngase en contacto con su distribuidor local en www.knex.com/distributors

419024.11-V1-01/19