















SAFETY INSTRUCTION

Please study the instruction manual and below information carefully before installing or using this product. Please keep this user manual for further reference

- The luminaires may only be installed by authorized and qualified technicians according the valid regulations for electrical installation.
- Maintenance of the luminaires is limited to their surfaces. During maintenance no moisture can come into contact with any areas of the terminal connections or voltage control parts.
- The electrical supply must be switched off at the outset, preferably by means of a switch in the distribution box, before any installation, maintenance or repair work is undertaken.
- Exterior lighting must not be installed during rain.
- Take account of the minimal separation distance from other objects and the room required around the fitting.
- If in any doubt, consult a professional, taking local installation requirements into account. Some countries stipulate that lighting may be installed only by registered installers.
- Clamping screws in electrical connections must be adequately tightened. This is particularly the case with 12V low voltage conductors.
- When replacing a halogen lamp, wait for it to cool, for a minimum of 5 minutes.
- Clean with a clean, dry cloth or brush, use no solvents or abrasives. Avoid dampness on all electrical components
- Take account of all available technical information.
- Take note of the symbols when connecting wires:
N = Neutral **L = Live** **⊕ = Earth**
- Meaning of symbols:

-  For indoor use only, where direct contact with water is impossible
-  This icon indicates the level of water-proof and dust-proof
-  Protection Class I: the fitting must be earthed
-  Protection Class II: the fitting is doubled insulated and does not require earthing
-  Protection Class III: the fitting is low voltage
-  Minimum distance from lighted objects (meters)
-  Only the self-shielded halogen lamp should be used with the luminaire
-  Strip the wire to the indicated length (mm); different items require different length
-  Connect using the specified cable; different items require different cables
-  The type of lamp and maximum size and wattage indicated in each lighting unit must not be exceed; different items require different kind of light sources with different bulb icons
-  220-240V~50Hz The armature is designed to work only with the indicated voltage. Different items require different working voltage.
-  The luminaire can be used in combination with a dimmer
-  The reference light angle and light space of the luminaire
-  This luminaire cannot be disposed together with normal domestic waste in standard rubbish can, but you have to bring it to a staging area for electrical waste



INSTRUCTION MANUAL



Uma FL
96862/96863

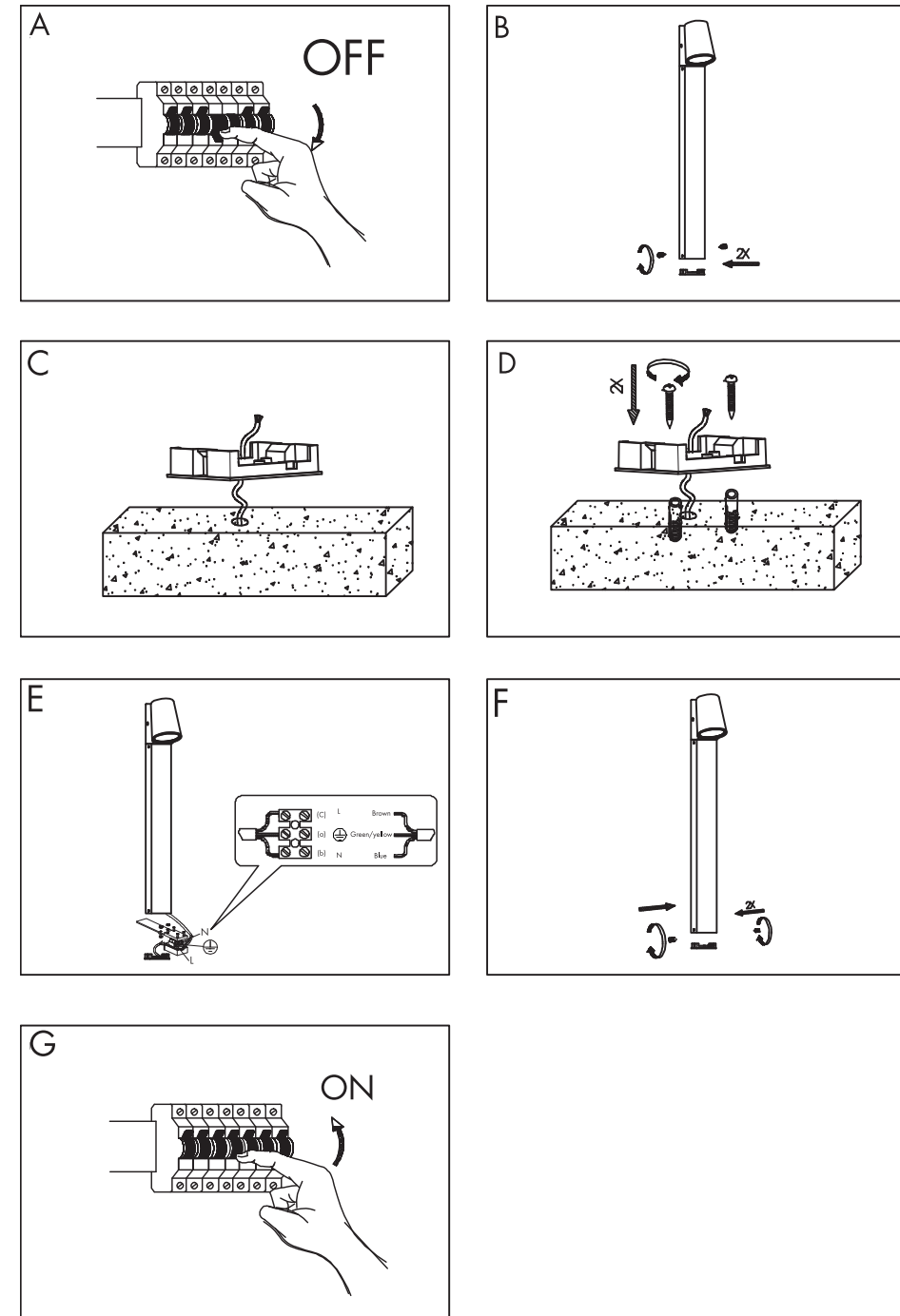

This item contains unchangeable LED

310	LM
6	W
3000	K
>80	CRI
30000	H
15000	ON/OFF

