



Inflatables

Assembly manual





Avyna

Inflatables - www.avyna.eu

Index

Contents	3
Setup & inflation	4 - 5
Deflation & storage	6 - 7
Repair kit instructions	8
Safety instructions	9 - 10
Installation	11 - 13
Use	14 - 16
Maintenance & Storage	17
Warranty	18 - 19

Contents

	Quantity	Part number	
Inflatable bouncer	1	AVHB-SK01-10	
Carrying bag	1	AVHB - bag	
Blower	1	Blower 1 - 4	
Bouncer stakes	6	AVHB - Anchor set	
Repair patches	4	AVHB - Repair	
Manual	1		

Setup & inflation

1



2



3



4



5



6



Setup & inflation

7



8



9



10

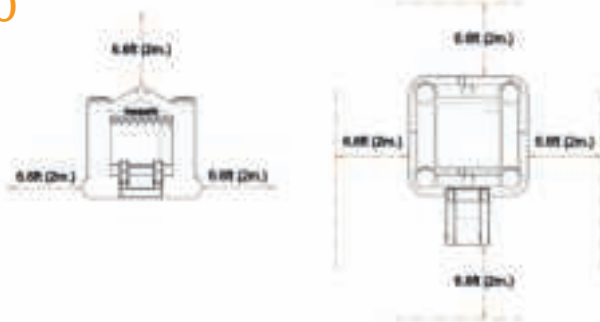

11



Deflation & storage

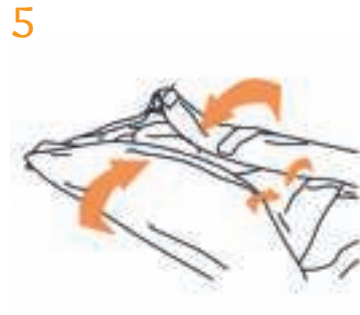
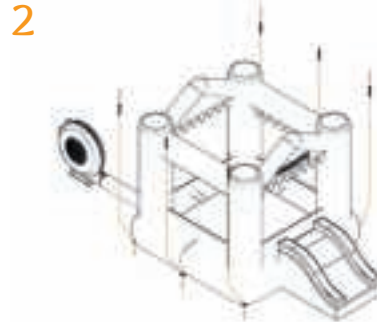

Deflation & storage

7



8



9



Repair kit instructions

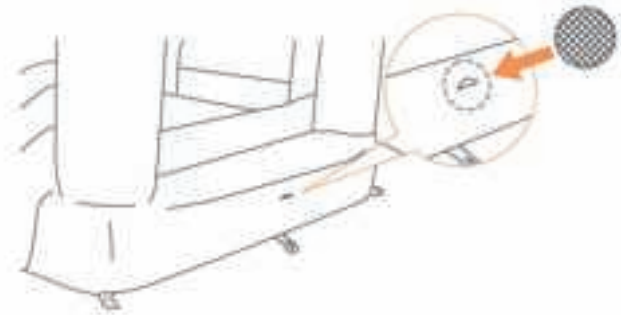

Repair patch instructions

1. Deflate the product, clean the area and allow to dry thoroughly.
2. Cut a portion of the patch to the size needed and round the corners (see above).
3. Remove the adhesive backing from the patch material, position the patch over the damaged area and smooth out any bubbles.
4. Allow to sit for 30 minutes before inflating.

Correct:



Incorrect:

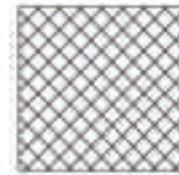

WARNING!

Repair patches must be applied by an adult only.

KEEP OUT OF REACH OF CHILDREN!

Safety warnings

Attention: Please do not return to the store. If you encounter problems or have questions, please call our qualified customer service technicians at +31 (0)161 29 43 33.

! CAUTION !

ELECTRICALLY OPERATED PRODUCT

- Operation of blower fan unit not recommended for children under 14 years of age.
- As with all electronic products, precautions should be observed during handling and use to prevent electric shock.
- **WARNING!** Failure to follow these instructions could result in serious injury or death.
- Do not use extension cords with this product.
Outdoor use only. Retain instructions with product.

! CAUTION !

USE ONLY ON EARTHED SOCKETS

Sketch A

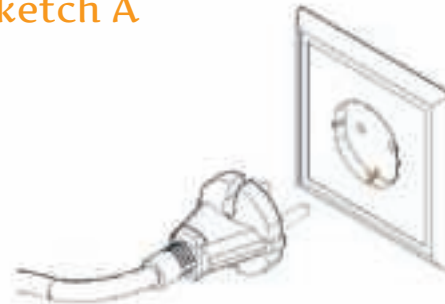

Safety warnings

EARTHING INSTRUCTIONS FOR ALL EARTHING, CORD-CONNECTED PRODUCTS:

- This product should be earthed. In the event of an electrical short circuit, earthing reduces the risk of electric shock by providing an escape for the electric current. This product is equipped with a cord having a earthing wire with an appropriate earthing plug. This plug must be plugged into an outlet that is properly installed and earthed in accordance with all local codes and ordinances.
- **DANGER!** Improper installation of the earthing plug can result in a risk of electric shock.
- If repair or replacement of the cord or the plug is necessary, do not connect the earthing wire to either flat blade terminal. The wire with insulation having an outer surface that is green, with or without yellow stripes, is the earthing wire.
- Check with a qualified electrician or serviceman if the earthing instructions are not completely understood, or if in doubt as to whether the product is properly earthed.
- Do not modify the plug provided, if it will not fit the outlet, have the proper outlet installed by a qualified electrician.
- For a earthed, cord-connected product, rated less than 15 amperes and intended for use on a nominal 220-240 volt supply circuit, these instructions must be followed.
- This product is for use on a nominal 220-240 volt supply circuit, and has a earthing plug that looks like the plug illustrated in sketch A.
- Temporary adapters should not be used.

Installation

ELECTRICAL BLOWER:

Safety warnings:

- This blower is NOT a toy. Use under the direct supervision of a competent adult. Keep away from children.

• ! CAUTION !

The blower is a high volume blower, and is capable of moving lots of air very quickly. Place the blower in an area where it will not suck in dirt or leaves. Keep away from water and traffic. Keep children away from the blower. Only the blower supplied should be used for inflation.

INSTRUCTIONS FOR BLOWER INSTALLATION:

- Set up as close to power source as possible.
- The product should be periodically examined for potentially unsafe conditions such as:
 - Damaged cord
 - Damaged plug
 - Damaged housing of part.

In the event of such damage the product should not be used until properly repaired.

- When in use, do not place the cord across traffic areas, water or damp areas.
- The blower should be placed on a stable surface and anchored per product instructions.
- The power cord of the blower is equipped with a earthed plug.

Installation

BOUNCER:

Adult supervision and setup required. This product should be inflated or deflated by a competent adult.

Follow all instructions provided.

- Intended for outdoor domestic family use only. Not for use in public areas or as a rental.
- Product should never be dragged across concrete, pavement or other rough surfaces.
- **WARNING!** Keep away from fire. Keep fabric clear of all flame and ignition sources.
- Do not set up in windy or rainy conditions, sudden gusts of wind may lift the product off of the ground.
- Product can be installed in any orientation in relation to the sun, since there are no metal components of surfaces that can absorb excessive solar radiation.

- Set-up in outdoor location only that meets the following criteria:

- Place on level ground on grass or dirt surface to allow proper use of stakes.
- Placing on slanted or uneven surfaces may cause the product to tip.
- Stakes should be placed at an angle for better anchorage.
- Stakes should be driven under the ground to prevent tripping.
- Minimum clearance zones:
Place at least 6.6 ft (2m) away from any other objects. Objects to be avoided include but are not limited to:

Installation

- Fences
 - Buildings
 - Trees or overhead branches
 - Laundry lines
 - Electrical wires
 - Walls
 - Or bodies or sources of water.
- Make sure the area round the product is secure by adding safety barriers, if necessary, to keep young children and pets from gaining access.
 - Electrical cord should not be passed under the air filled devices (inflatable bouncer) and interfere with its operation.
- The bouncer uses a main powered blower (air pump) to maintain pressure, only to be used by an adult.
 - Only the blower supplied should be used for inflation.
 - Do not use extension cords with this product. Set up as close to a power source as possible. The blower should be securely anchored to the ground before use.
 - **ATTENTION!** blower should remain on and continuously inflate bouncer during use. Airflow through seams is normal. Do not try to seal or repair seams.

Use

BLOWER:

- Outdoor use only
- This blower is for residential use only. It is not intended for use in commercial or industrial settings.
- Never insert fingers, pencils or any other object through the grill at ANY time.
- Do not operate blower after the appliance malfunctions or has been dropped or damaged in any manner.
- Do not operate in the presence of explosive and/or flammable fumes.
- To reduce the risk of electric shock, do not use this blower with any solid-state speed control device.
- **WARNING!** – electronic hazard – do not use extension cords with this product.
- Always unplug the blower before servicing.

BOUNCER:

- Constant, competent adult supervision of children and other young users is required at all times.
- Keep the area around the product clean, and clear of objects, to prevent slips or falls.
- Do not allow children to play in it until it is fully inflated.
- Do not allow children to play on it if wet. Thoroughly dry before use.
- This is not an aquatic toy. It is not to be used in water.
- Instruct children in proper use of this product:
 - Children should not wear loose or baggy clothing, scarves, hoods or clothing with drawstrings of long cords while playing on this product.

Use

- Children must remove helmets, headgear, shoes and glasses, as well as any sharp objects from their pockets, as they may puncture the bouncing surface.
- Toys and other objects should never be allowed inside the bouncer.
- Instruct children not to attach items to the product that are not specifically designed for use with the equipment, such as but not limited to:
 - Jump ropes
 - Clothesline
 - Pet leashes
 - Cables
 - ChainsAs they may cause a strangulation hazard.
- Keep pets away from product.
- Children should bounce away from others, and stay away from openings and side walls.
- Children should not jump onto or off the product.
- Total weight of the children must not exceed 250 lbs. (113 kg).
- No more than 3 children should play on the bouncer at the same time.
- Do not allow children to play together who are unevenly matched in weight and height.
- Before and during use, check for air loss. Check blower is properly connected.
- Always check the product and all its anchorage points before and during use, and to re-secure as appropriate.

Use

- After inflation, blower should run continuously while children are playing.
- Prior to deflation, remove all children.
- Always deflate product after use, and store indoors.
- To be used on soft ground only.
- Users must be discouraged from attempting any unauthorized modification.

Maintenance & Storage

BLOWER:

- To prevent electric shock: do not immerse in water, wipe clean with damp cloth. Failure to follow these instructions could result in serious injury or death.
- Unplug the blower before cleaning.
- Never leave the blower outside in the rain or exposed to the elements when not in use.
- The product should be periodically examined for potentially unsafe conditions such as:
 - Damaged cord
 - Damaged plug
 - Damaged housing or part.

In the event of such damage the product should not be used until properly repaired.

- The blower doesn't need any lubrication and has no serviceable parts. Do not attempt to service the blower.

- When not in use, store the blower indoors in a dry place.
- Store the blower upright on a stable surface.
- Loosely coil cord and place it beside the blower.
- Never leave the blower outside in the rain or elements when not in use.

BOUNCER:

- As an outdoor product, the bouncer is subject to wear and deterioration. Inspect for signs of fabric failure; weak or torn surfaces must be repaired promptly.
- To keep the product clean: wipe the bouncer using a dry cloth or a cloth dampened with a neutral, non-inflammable, non-toxic cleaning and sanitizing solution or pure water.
- Product should never be stored wet. Allow to dry before rolling up.

Warranty

The AVYNA Company makes fun, high quality toys. We warrant to the original purchaser that this product is free of defects in materials or workmanship for one year from the date of purchase (dated sales receipt is required for proof of purchase). At the sole election of The AVYNA Company, the only remedies available under this warranty is will be either replacement of the defective part of the product or refund the purchase price of the product. This warranty is valid only if the product has been assembled and maintained per the instructions. This warranty does not cover abuse, accident, cosmetic issues such as fading or scratches from normal wear, or any other cause not arising from defects in material and workmanship.

EUROPE:

For warranty service or replacement part information, please visit our web-site at www.avyna.eu, call +31 (0) 161 29 43 33 or write to:

CONSUMER SERVICE

The AVYNA Company

Beneluxlaan 7

5121 DC Rijen

The Netherlands

Warranty

Some replacement parts may be available for purchase after warranty expires - contact us for details.

Wet and dry inflatable bouncers warranty: We warrant to the original purchaser that the fabric in this product is free of defects in materials or workmanship for 1 year from the date of purchase, and the blower is free of defects in material or workmanship for one year from the date of purchase (dated sales receipt is required for proof of purchase).

OUTSIDE EUROPE:

Contact place of purchase for warranty service.





Sales office:

Beneluxbaan 7
5121 DC Rijen
The Netherlands

sales@avyna.eu
www.avyna.eu