

1

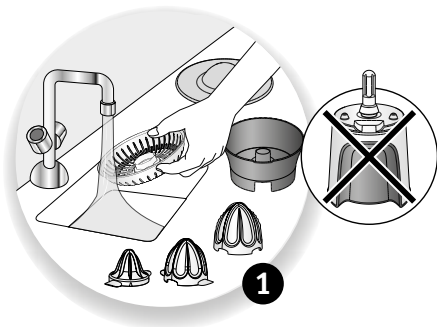

2

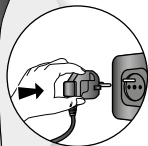

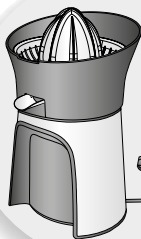
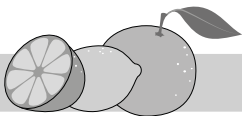
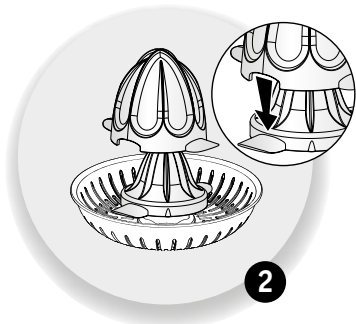
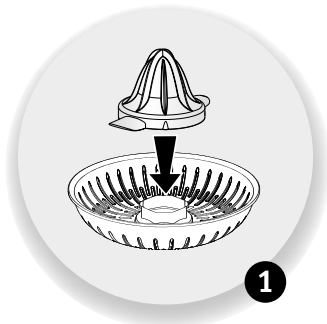
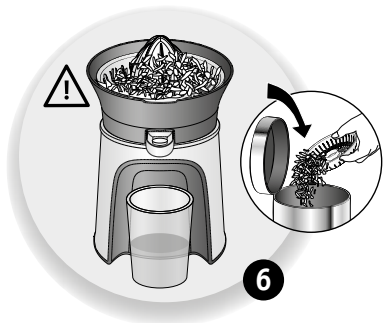
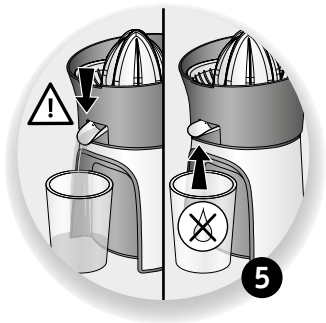
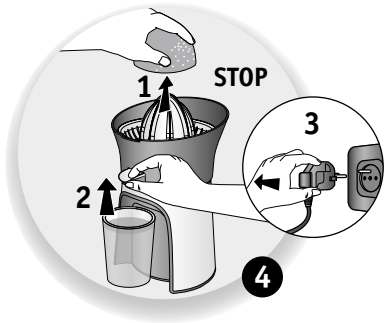

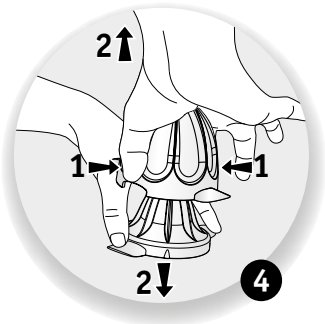
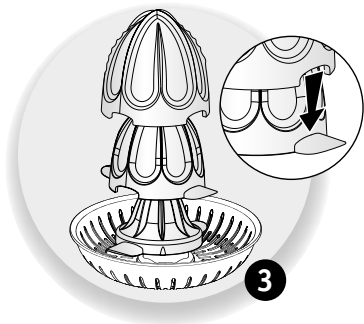



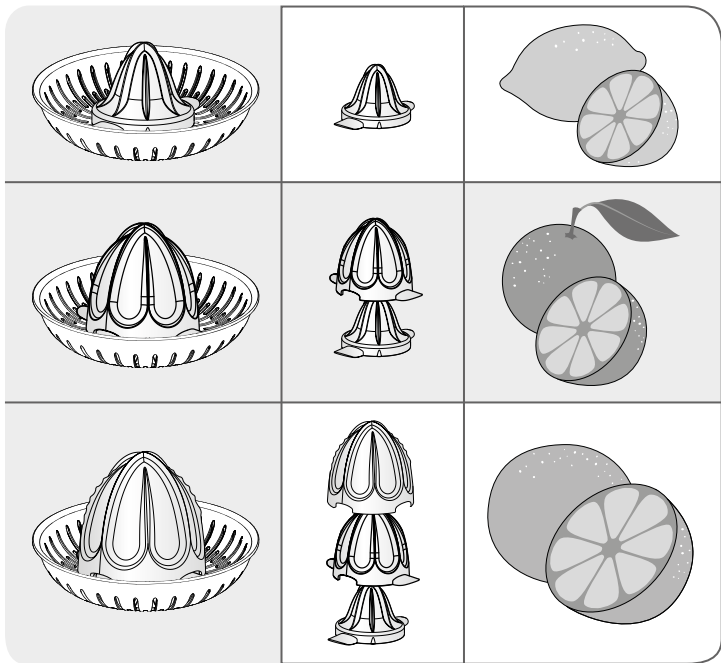
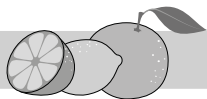







4



5

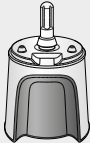

6

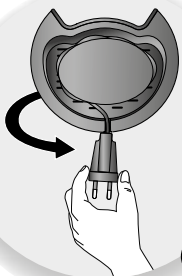

1

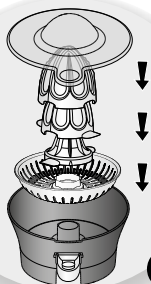

2

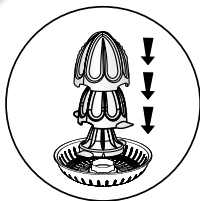
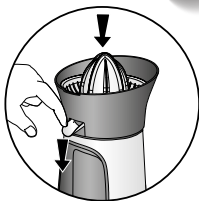
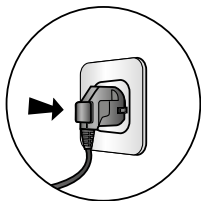
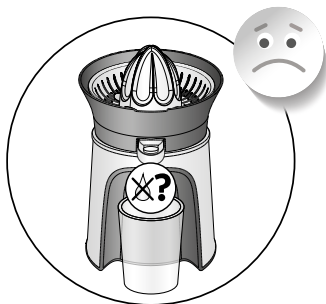

## INTERNATIONAL GUARANTEE: COUNTRY LIST

ARGENTINA	0800-122-2732	مصر EGYPT	16622	SLOVENIJA SLOVENIA	02 234 94 90	MALAYSIA	603 7802 3000	
ՀԱՅԱՍՏԱՆ ARMENIA	010 55-76-07	EESTI ESTONIA	668 1286	ΕΛΛΑΔΑ GREECE	2106371251	MEXICO	(01800) 112 8325	
AUSTRALIA	1300307824	SUOMI FINLAND	09 622 94 20	香港 HONG KONG	8130 8998	MOLDOVA	22 929249	
ÖSTERREICH AUSTRIA	01 890 3476	France Continentale + Gadeloupe, Réunion, Martinique, Saint-Martin	09 74 50 47 74	MAGYARORSZÁG HUNGARY	06 1 801 8434	NEDERLAND The Netherlands	0318 58 24 24	
البحرين BAHRAIN	17716666	DEUTSCHLAND GERMANY	0212 387 400	INDONESIA	+62 21 5793 7007	NEW ZEALAND	0800 700 711	
БЕЛАРУСЬ BELARUS	017 2239290	عمان سلطنة OMAN	24703471	ITALIA ITALY	1 99 207 354	NORGE NORWAY	815 09 567	
BELGIQUE BELGIE BELGIUM	070 23 31 59	POLSKA POLAND	801 300 420 koszt jak za połączenie lokalne	日本 JAPAN	0570-077772	SOUTH AFRICA	0100201730	
BOSNA I HERCEGOVINA	Info-linija za potrošače 033 551 220	PORTUGAL	808 284 735	الأردن JORDAN	5665505	ESPAÑA SPAIN	902 31 24 00	
BRASIL BRAZIL	11 2915-4400	قطر QATAR	44485555	ҚАЗАҚСТАН KAZAKHSTAN	727 378 39 39	SVERIGE SWEDEN	08 594 213 30	
БЪЛГАРИЯ BULGARIA	0700 10 330	REPUBLIC OF IRELAND	01 677 4003	한국어 KOREA	1588-1588	SUISSE SCHWEIZ SWITZERLAND	044 837 18 40	
CANADA	1-800-418-3325	ROMANIA	0 21 316 87 84	الكويت KUWAIT	24831000	ประเทศไทย THAILAND	02 769 7477	
CHILE	02 2 884 46 06	РОССИЯ RUSSIA	495 213 32 30	LATVIJA LATVIA	6 616 3403	TÜRKIYE TURKEY	444 40 50	
COLOMBIA	018000520022	المملكة العربية السعودية SAUDI ARABIA	920023701	لبنان LEBANON	4414727	المتحدة العربية الامارات UAE	8002272	
HRVATSKA CROATIA	01 30 15 294	SERBIA SERBIA	060 0 732 000	LIETUVA LITHUANIA	5 214 0057	Україна UKRAINE	044 300 13 04	
ČESKÁ REPUBLIKA CZECH REPUBLIC	731 010 111	SINGAPORE	6550 8900	LUXEMBOURG	0032 70 23 31 59	UNITED KINGDOM	0345 602 1454	
DANMARK DENMARK	44 663 155	SLOVENSKO SLOVAKIA	232 199 930	МАКЕДОНИЈА MACEDONIA	(02) 20 50 319	U.S.A.	800-395-8325	
ECUADOR	0800-7268724						22/12/2015	

Date of purchase: ..... / Date d'achat / Fecha de compra / Data da compra / Data d'acquisto / Kaufdatum / Aankoopdatum / Kopsdato / Inköpsdatum / Kjøpsdato / Ostoptäva / Data zakupu / Data vânzării / Įsigijimo data/ Ostukauptev / Datum nákupu / Sorozatszám / Datum nákupu / Pirkuma datums / Datum Kupovine / Datum kupnje / Data cumprării / Datum nákupu / Tariikh pembelian / Tanggal pembelian / Ngáy mua hàng / Satin alma tarihi / Дата продажи / Дата на закупуване / Датум на купување / Сатылган мерзими / Ημερομηνία αγοράς / Цыбланытх оррр / 購買日期 / 購入日 / 구입일자 / تاريخ التزاد / تاریخ خرید

Product reference: ..... / Référence du produit / Referencia del producto / Nome do produto / Tipo de prodotto / Турnummer des Gerätes / Artikelnummer van het apparaat / Referencenummer / Produktreferens / Artikkelnummer / Tuotenumero / referencia produktu / Model / Gammio numeris / Toote viitenumber / Tur aparata / Vásárlás kelte / Тур výroby / Produkta atsaucens numurs / Model proizvoda / Označka proizvoda / Cod produs / Produk rujukan / Referensi produk / Mã sản phẩm / Urin kodu / Модель / Модель / Модел на уреду / Модел / Кодовый артикул / 產品名稱 / 製品レファレンス番号 / 제품명 / مرجع كاتل محصول / مرجع المنتج الكاتل / 購買日期 / 購入日 / 구입일자 / تاريخ التزاد / تاریخ خرید

Retailer name and address: ..... / Nom et adresse du vendeur / Nombre y dirección del minorista / Nome e endereço do revendedor / Nome e indirizzo del negozio / Name und Anschrift des Händlers / Naam en adres van de dealer / Forhandler navn & adresse / Återföreljarens namn och adresse / Forhandler navn og adresse / Jälleenmyyjän nimi ja osoite / Nazwa i adres sprzedawcy / Numele și adresa vânzătorului / Parduotolesų pavadinimas ir adresas / Müitja kauplus ja address / Naziv in naslov trgovine / Tipusszám / Nazov a adresa predajcu / Veikala nosaukums un adrese / Naziv i adresa maloprodaje / Naziv i adresa prodavca / Tuote ja adressi / Nazev a adresa prodajce / Nama dan alamat peruncit / Nama Toko Penjual dan alamat / Тэн və дiа chi citi häng bän/ Saticı firmam adı ve adresi / Название и адрес продавца / Назва i adresa prodavca / Търговия обект / Назив и адреса на продавницата / Сатушынын аты және мекен-жайы / Etusuoja / 產品名稱 / 製品レファレンス番号 / 제품명 / مرجع كاتل محصول / مرجع المنتج الكاتل / 購買日期 / 購入日 / 구입일자 / تاريخ التزاد / تاریخ خرید

Distributor stamp ..... / Cachet distributeur / Sello del distribuidor / Carimbo do revendedor / Timbro del negozio / Händlerstempel/ Etampel neve, de dealer / Forhandler / Handter / Återföreljarens stämpel / Forhandler stempel / Jälleenmyyjän leima / Pieczęć sprzedawcy / Štampila vânzătorului / Aispuasdas / Tempel / Žig trgovine / Stempel van de dealer / Razitko prodavca / Zimogs/ Pečat maloprodaje/ Pečat prodavca / Pečat prodajnog mjesta/ Štampila vânzătorului/ Razitko prodaje/ Cap peruncit / Cap dari Toko Penjual / Căta häng bän dōng dău/ Saticı Firmam Kaçesi / Pečat prodavca / Pečatka prodavca / Pečat na trgovijskij objekt / Pečat na prodavnica / Сатушынын мөбл / Σερτυφιωνη κληροση / Цыбланытх клыбэрр / 購買日期 / 購入日 / 구입일자 / تاريخ التزاد / تاریخ خرید