

15214



RAD RIDES Alternate Builds



3 Wheeler
page 1



Big Rig
page 8



Coupe Racer
page 17



Hot Rod
page 24



Amphibious Vehicle
page 33



Super Car
page 41



Rocket Racer
page 47



SUV
page 53



Tow Truck
page 60



1

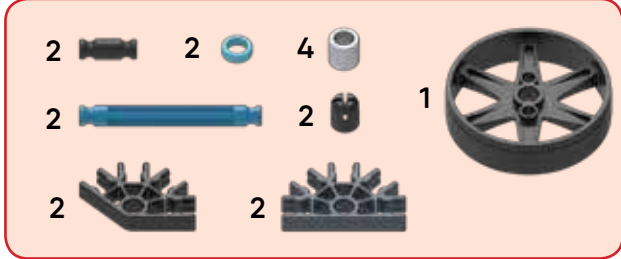
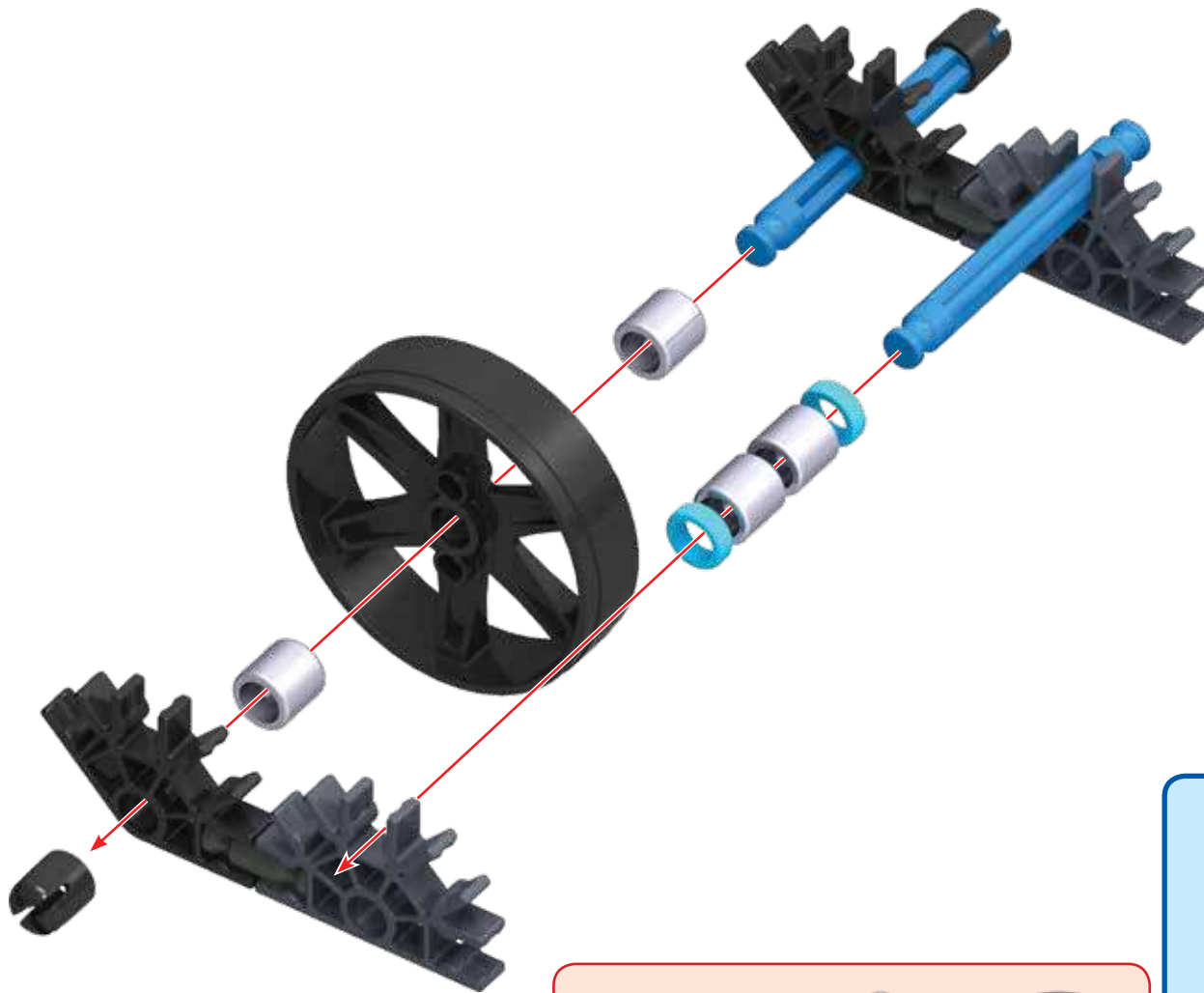

1

2

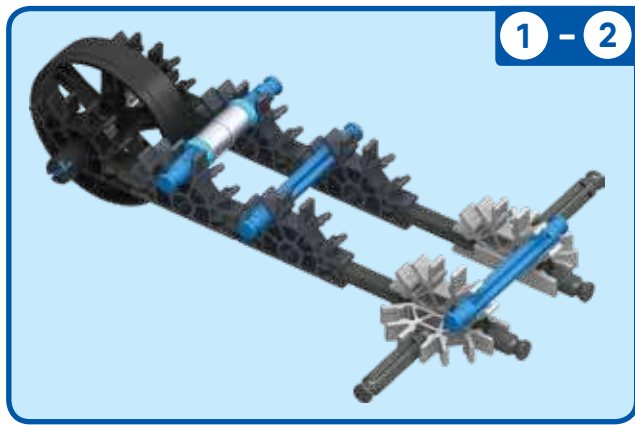
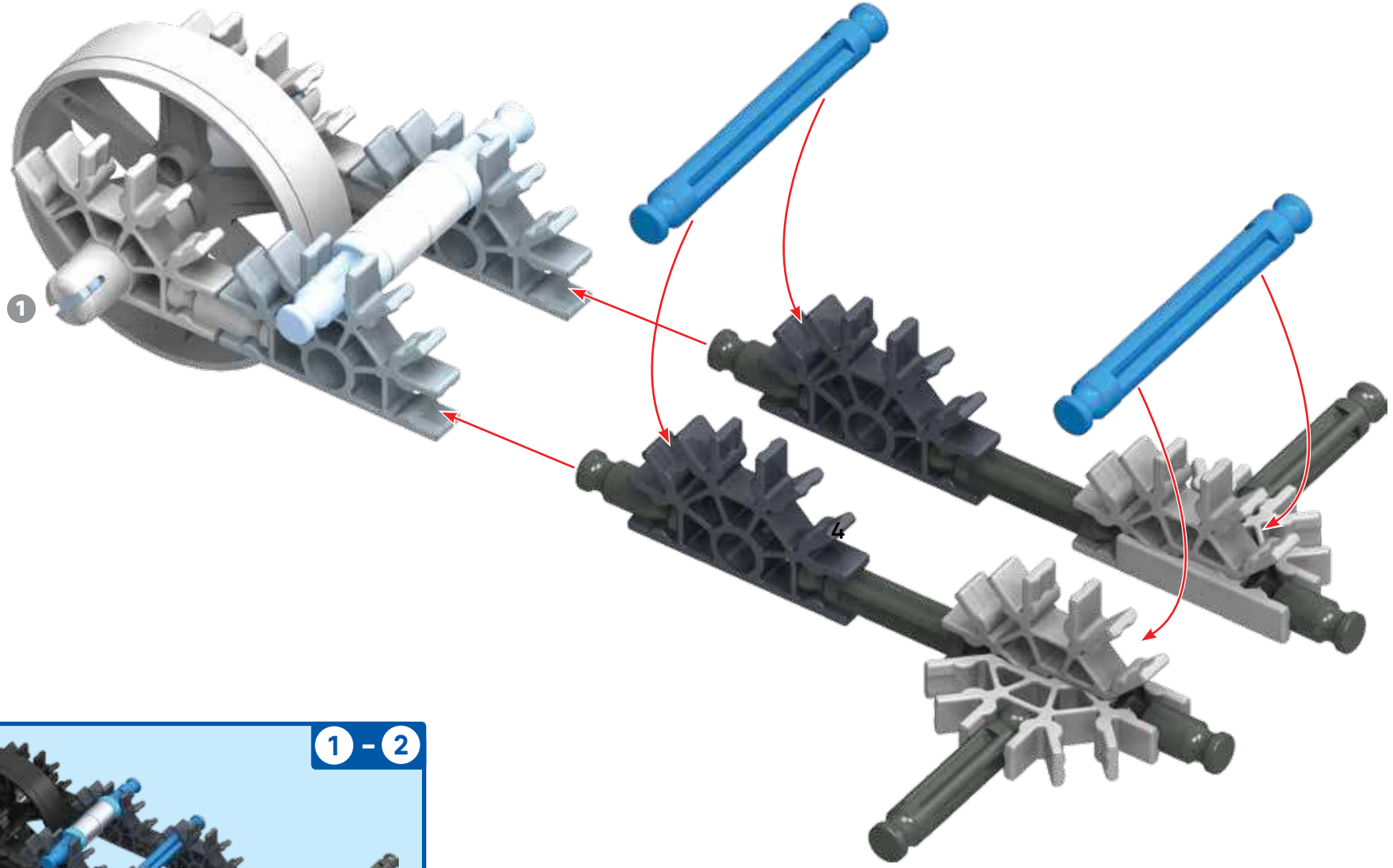

- 4 [Small dark grey pin]
- 4 [Long dark grey axle]
- 2 [Blue pin]
- 4 [Large grey gear]
- 2 [Medium grey gear]

3

- | | | | | | | | |
|---|--|---|--|---|--|---|--|
| 4 | | 2 | | 1 | | | |
| 2 | | 6 | | 4 | | 2 | |
| 2 | | 2 | | 2 | | | |

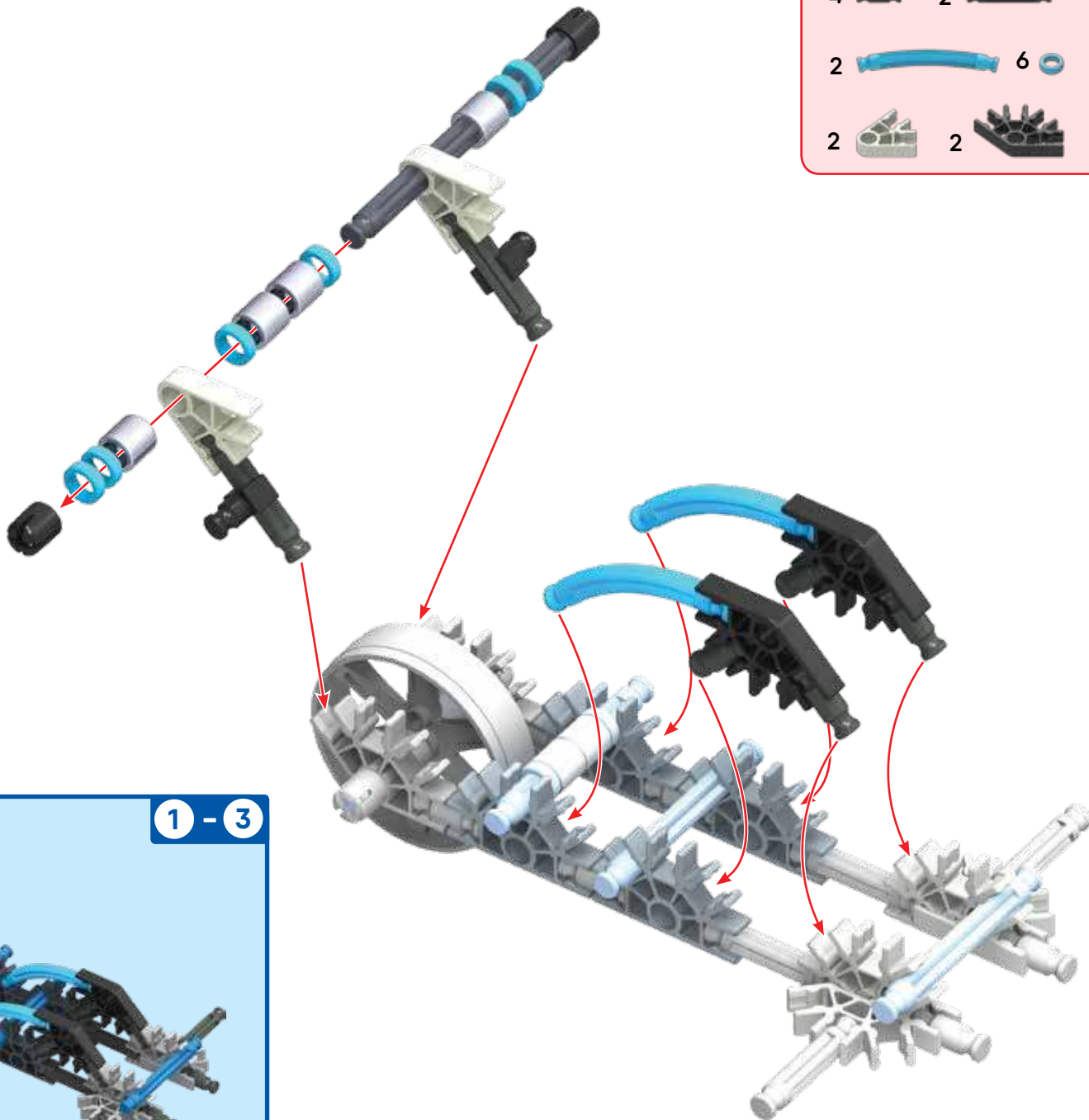

1 - 3

1 - 2

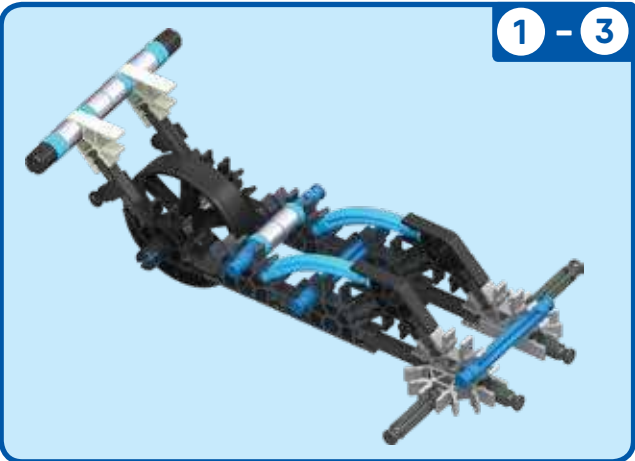

4

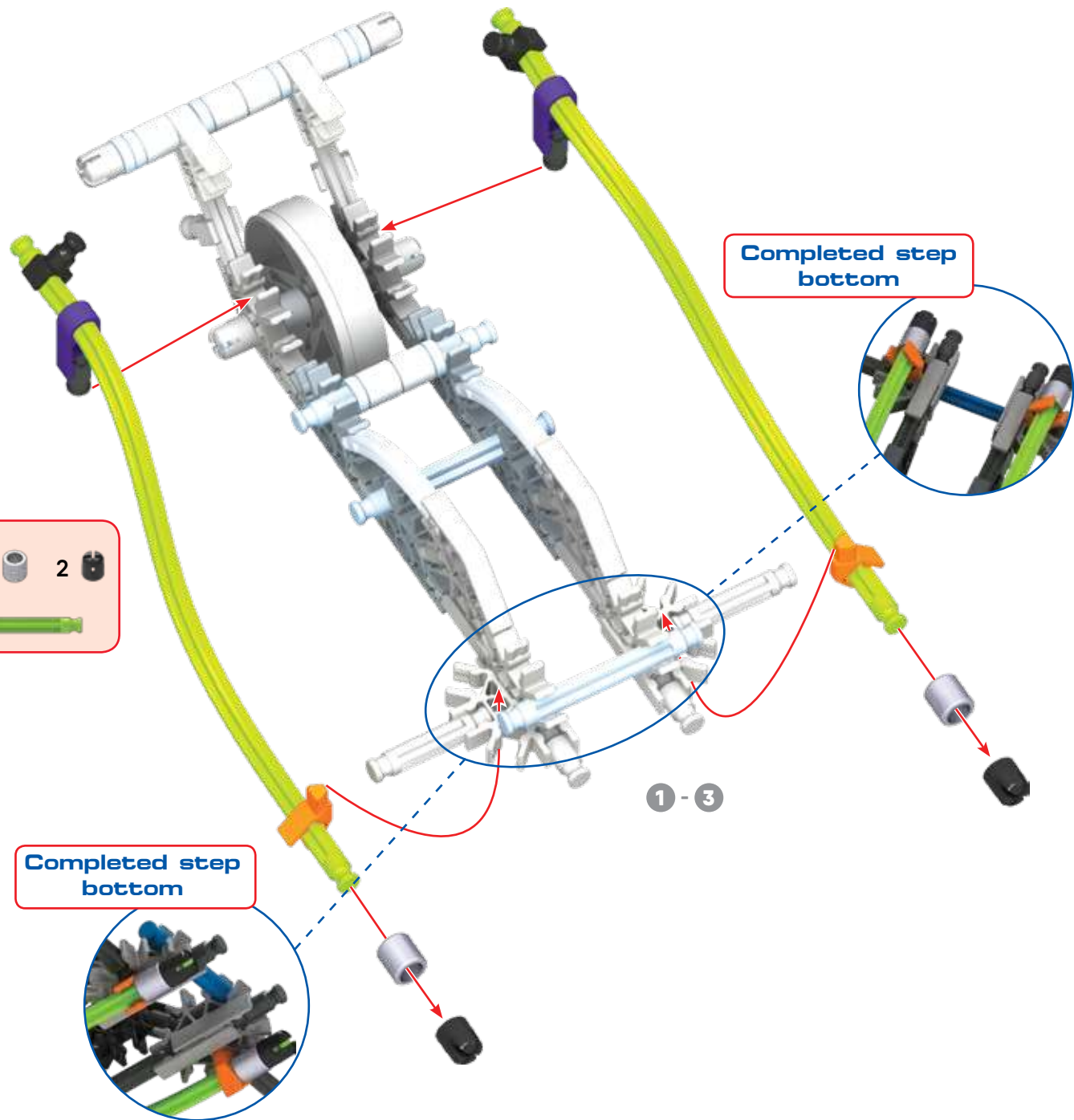

- 2 [black pin]
- 2 [black pin]
- 2 [orange pin]
- 2 [purple pin]
- 2 [grey pin]
- 2 [black pin]
- 2 [green cable]



Completed step bottom

5

- 1 
- 2 
- 2 
- 4 
- 4 
- 2 

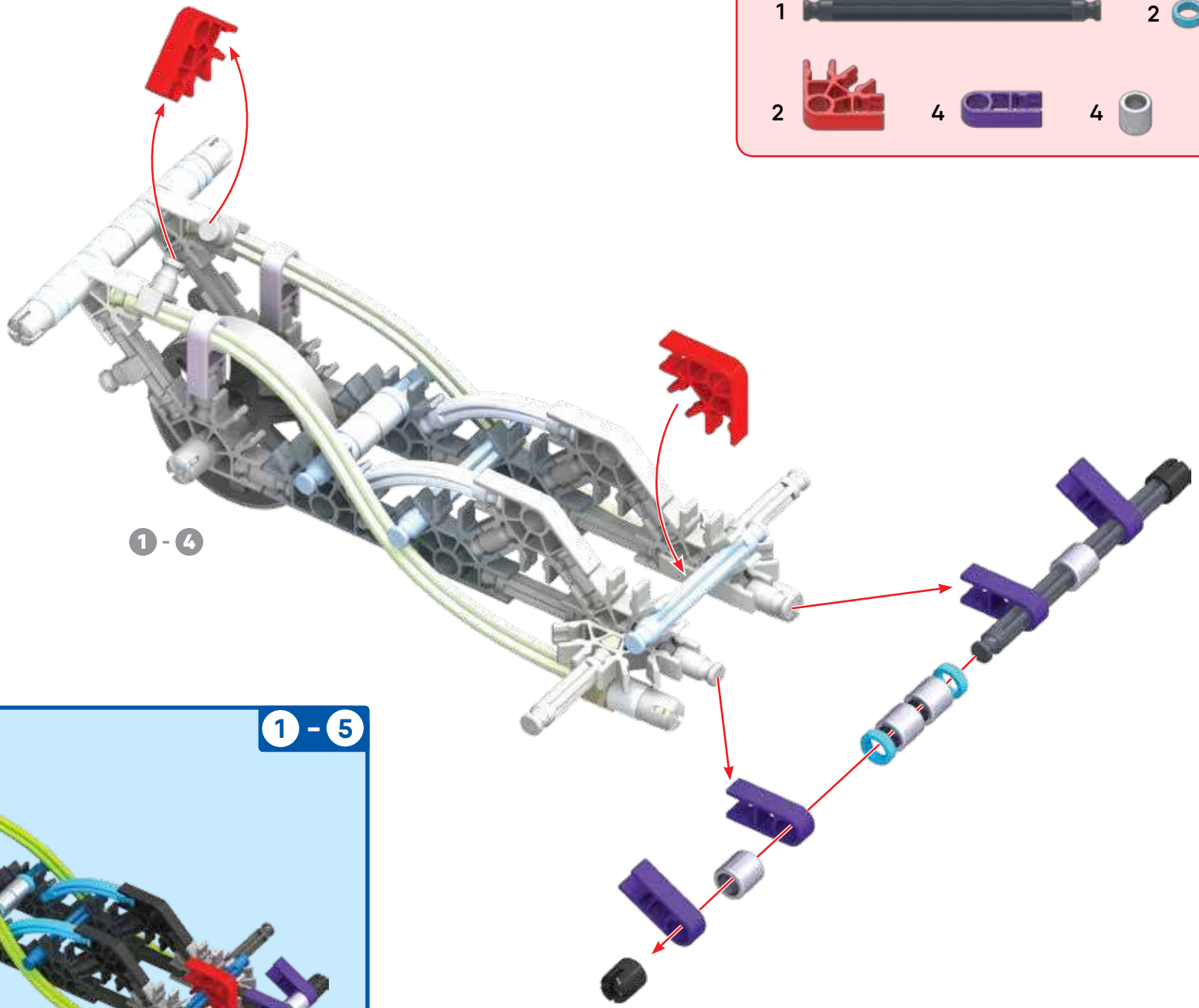

1 - 5

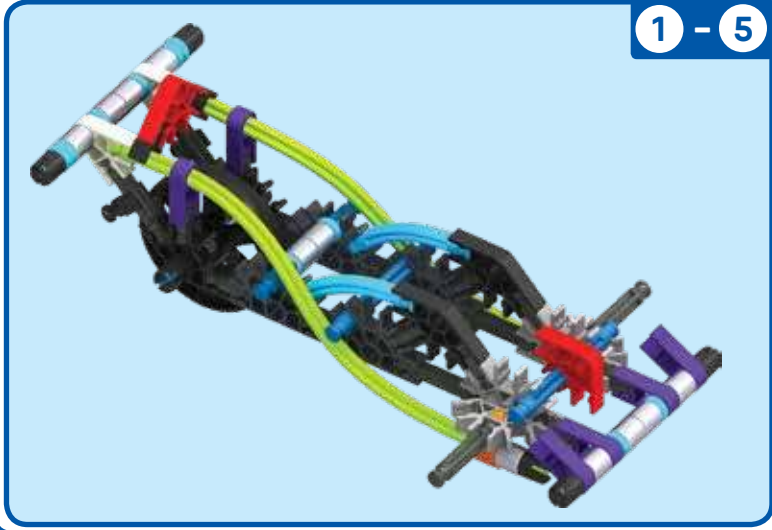

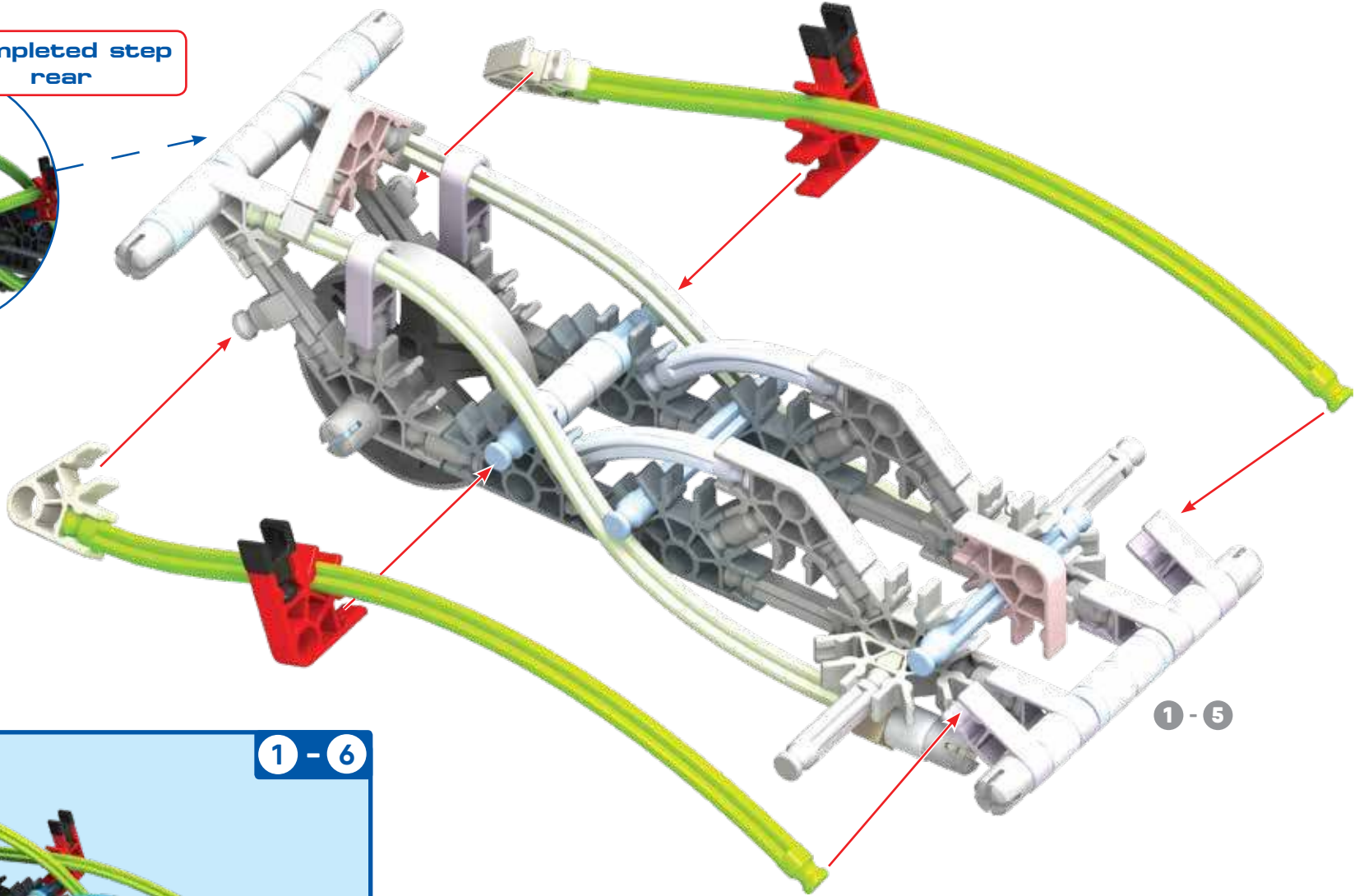

6

Completed step rear

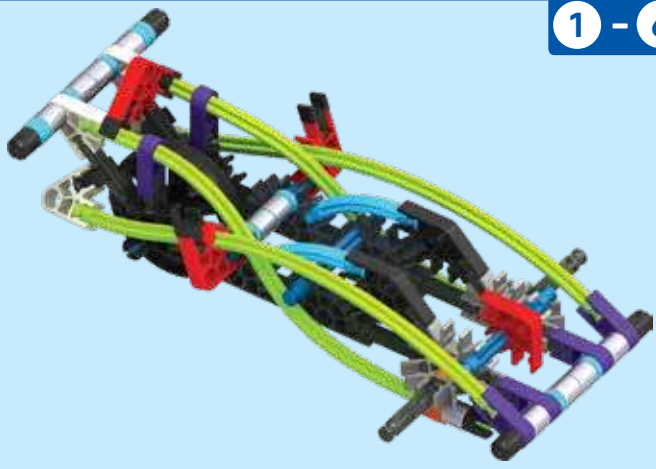

1 - 6



- 2  2  2 
- 2 

7

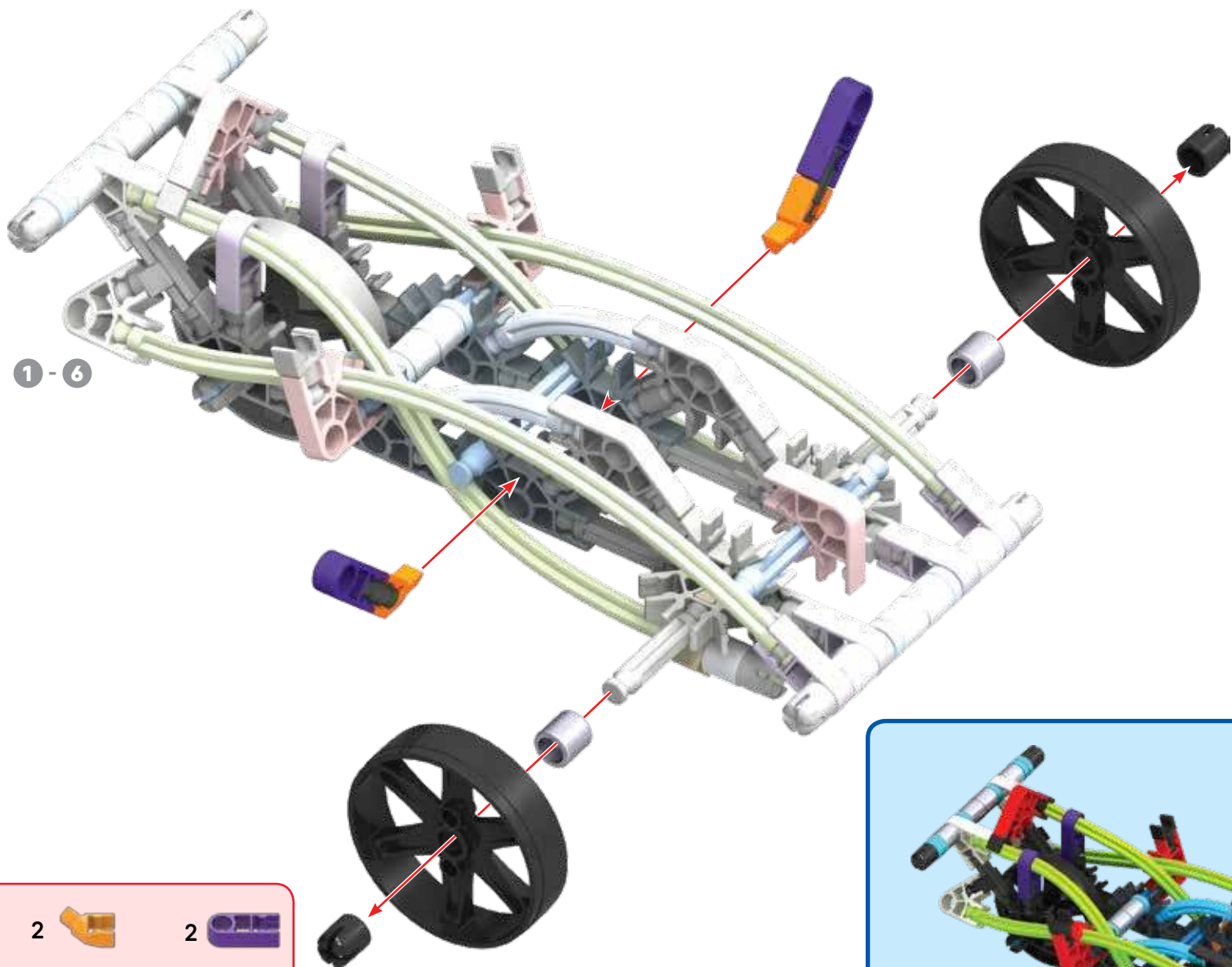

- 2
- 2
- 2
- 2
- 2
- 2



1

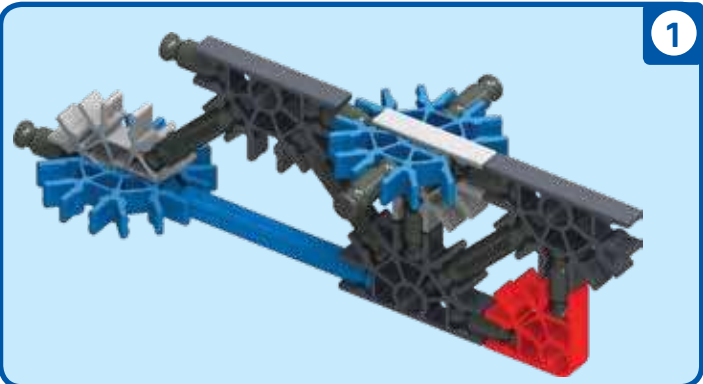
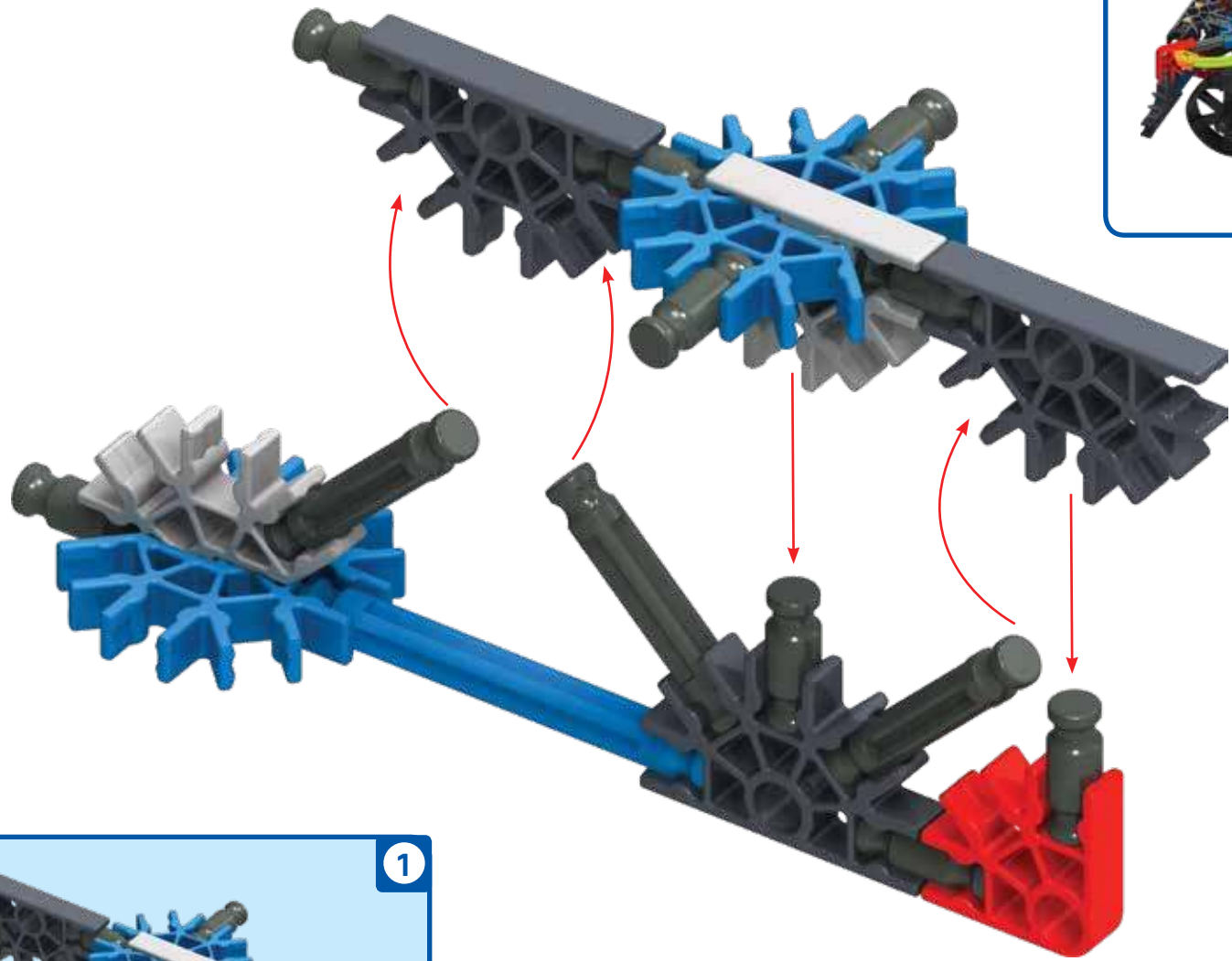

- | | | | | | | | |
|---|--|---|--|---|--|---|--|
| 1 | | 2 | | 3 | | 2 | |
| 9 | | 3 | | 1 | | | |

2

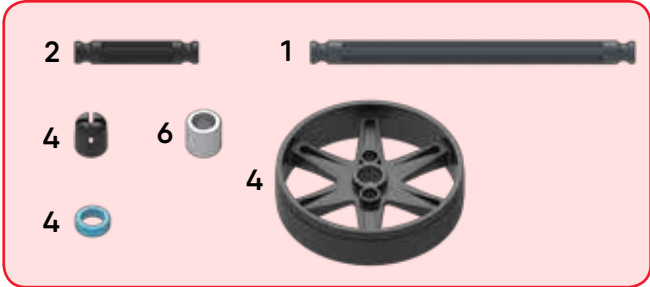
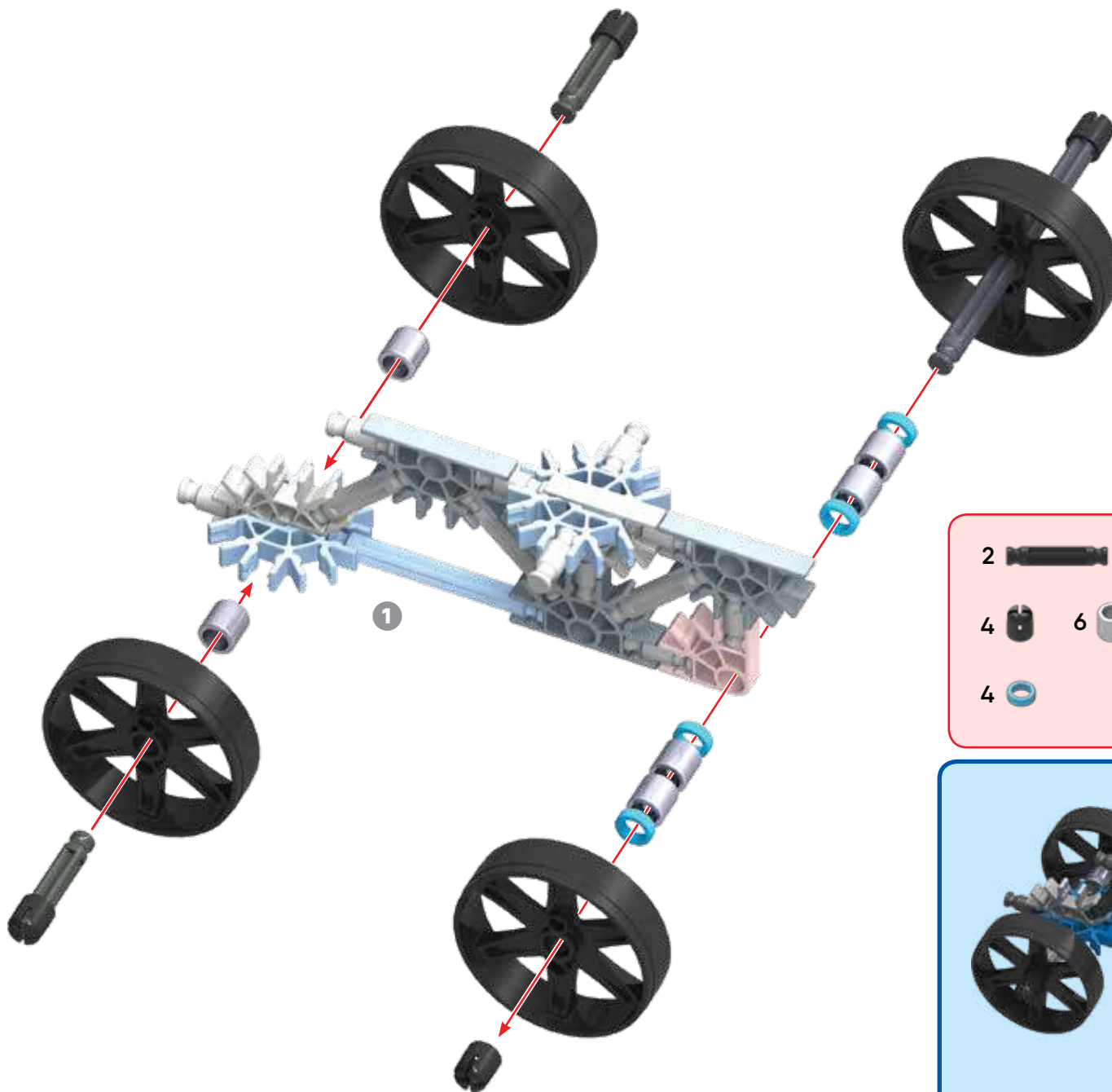

3





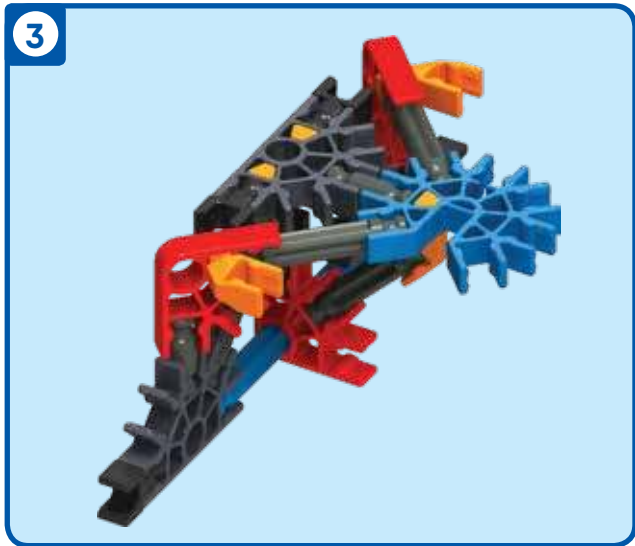



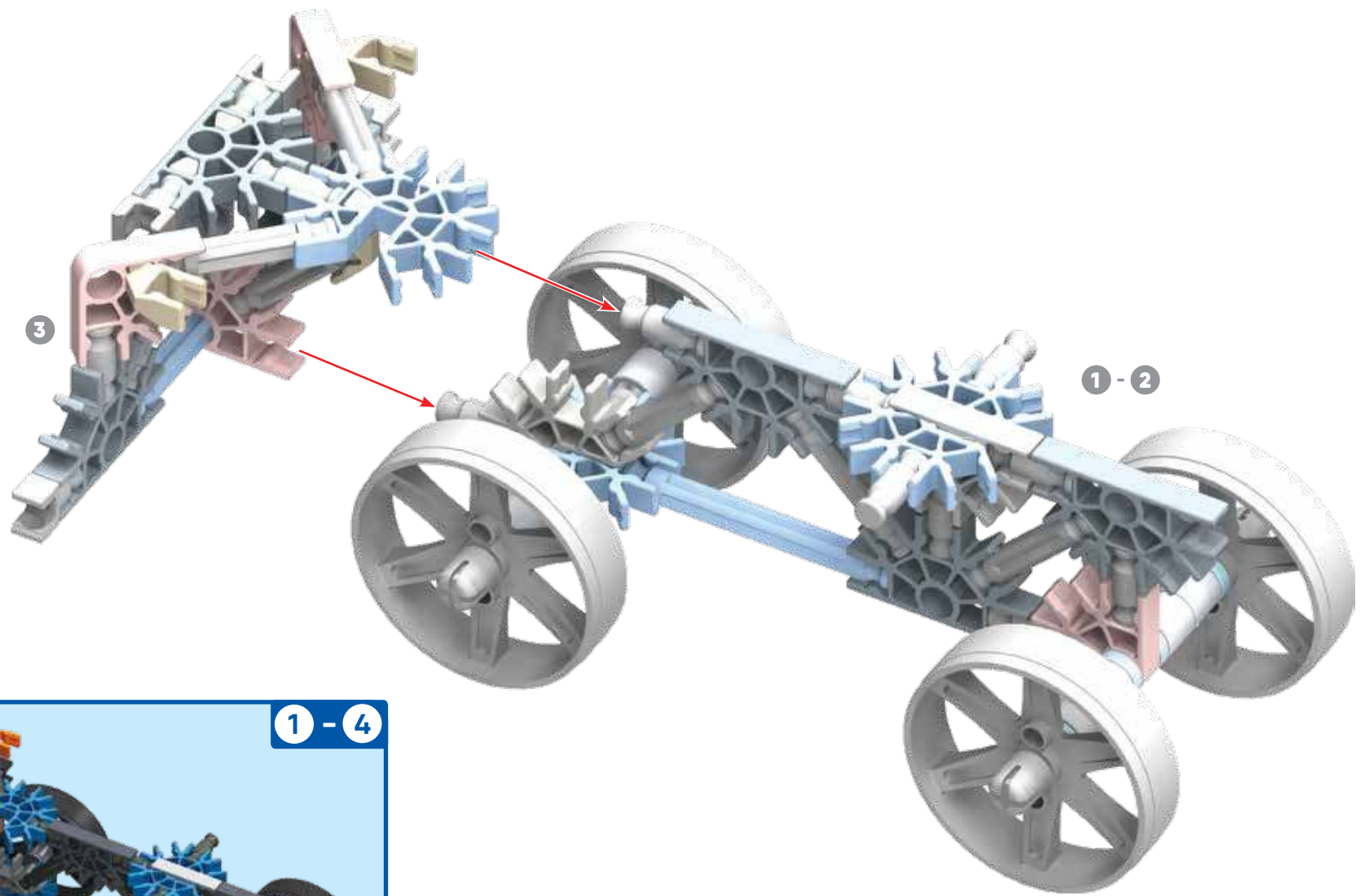



- | | | | | | |
|---|--|---|--|---|--|
| 3 | | 3 | | 1 | |
| 3 | | 5 | | 1 | |
| 5 | | 5 | | | |



4



5

- 2  2  2  2 
- 2  8  2 
- 1  2  2 

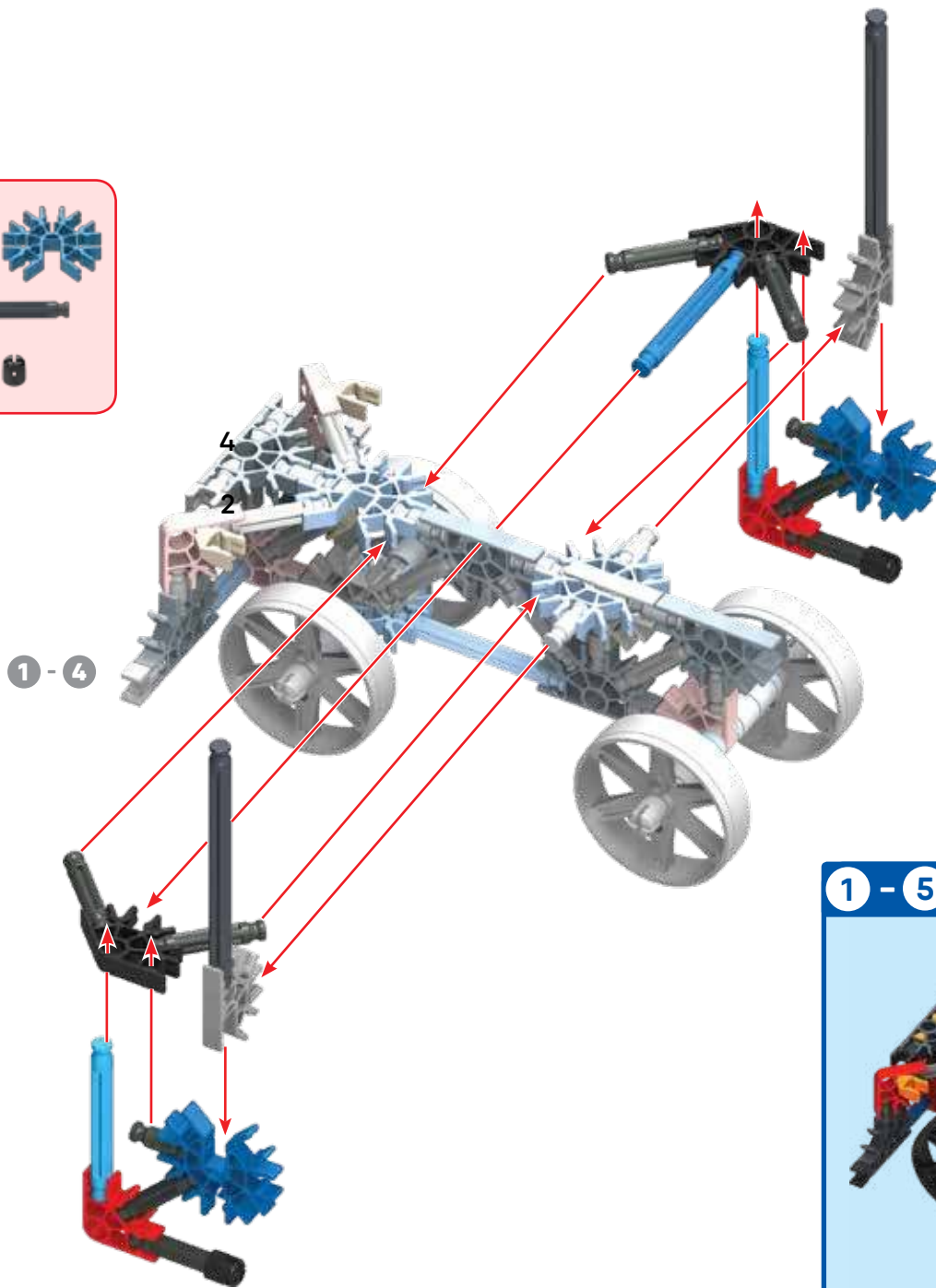

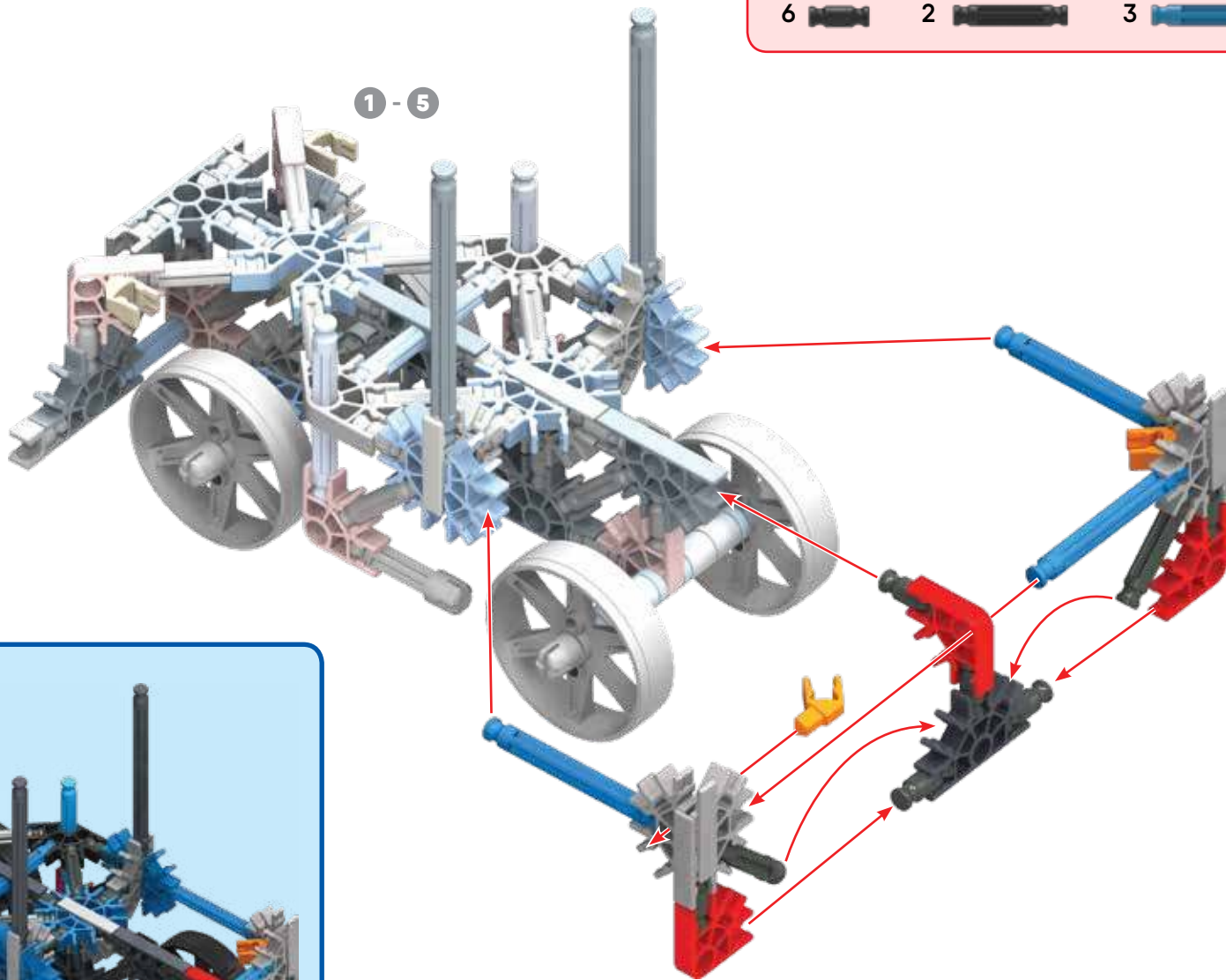
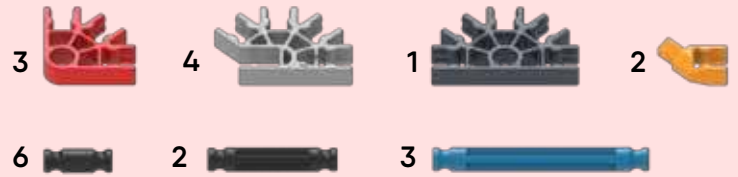

6



1 - 6



7

- 2  2 
- 2 

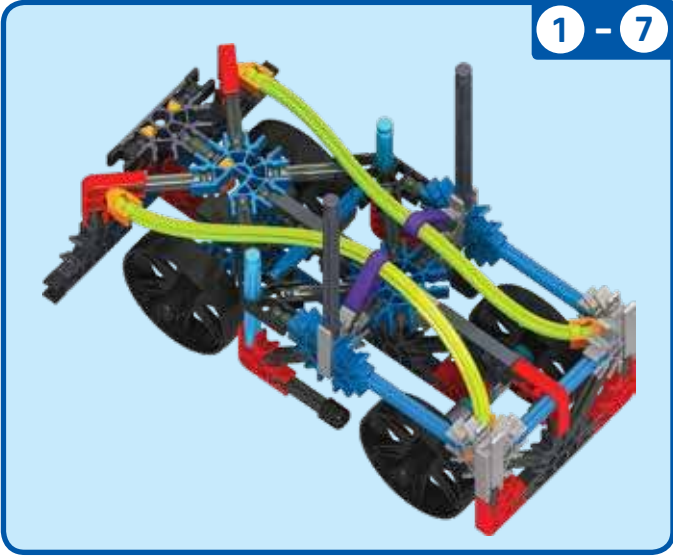
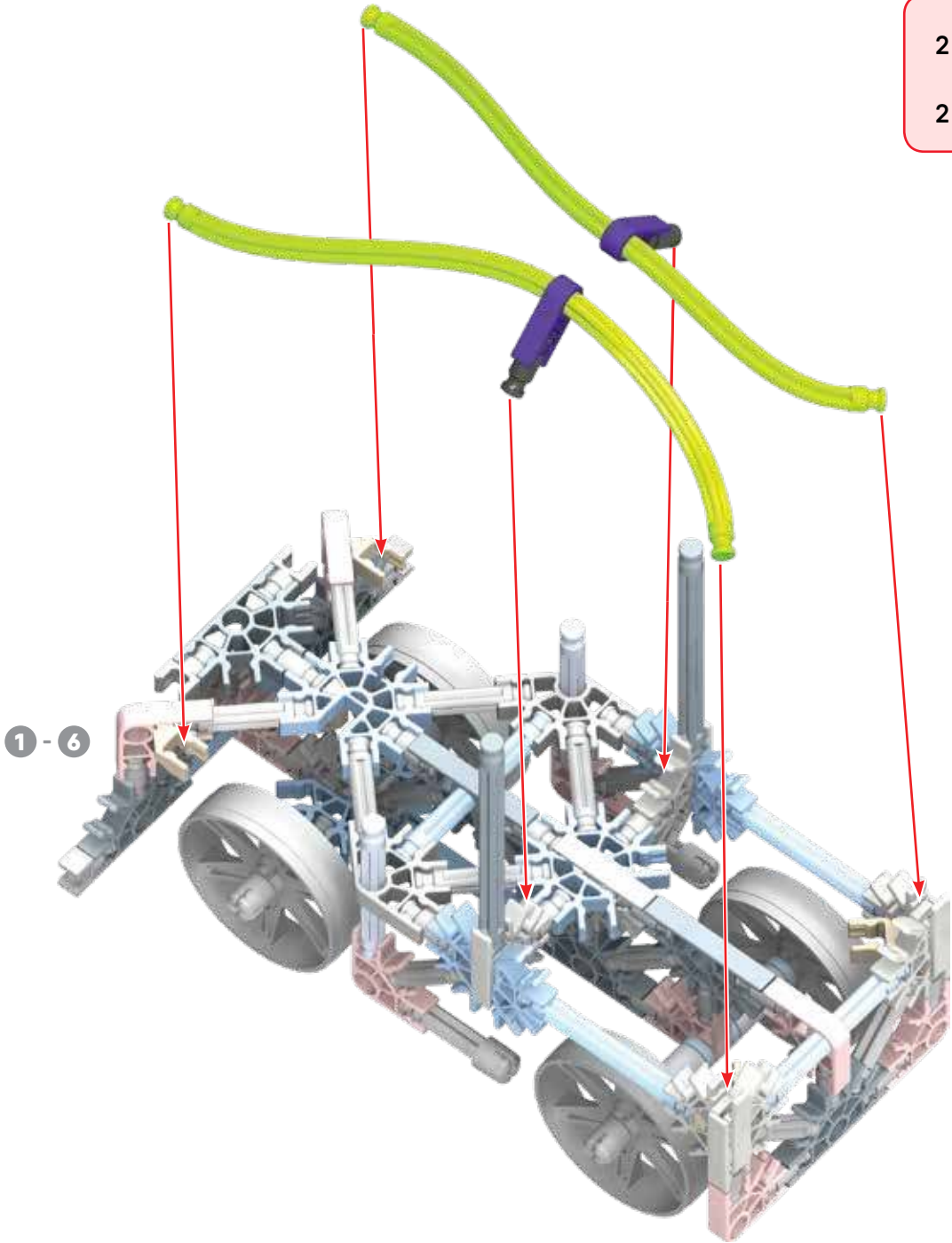

8

8  4 

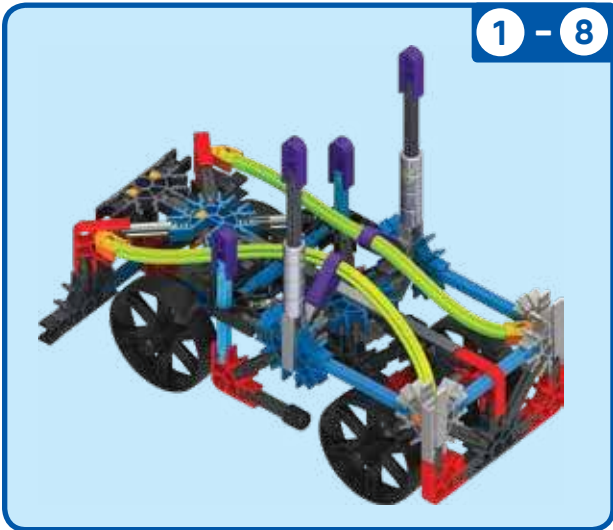
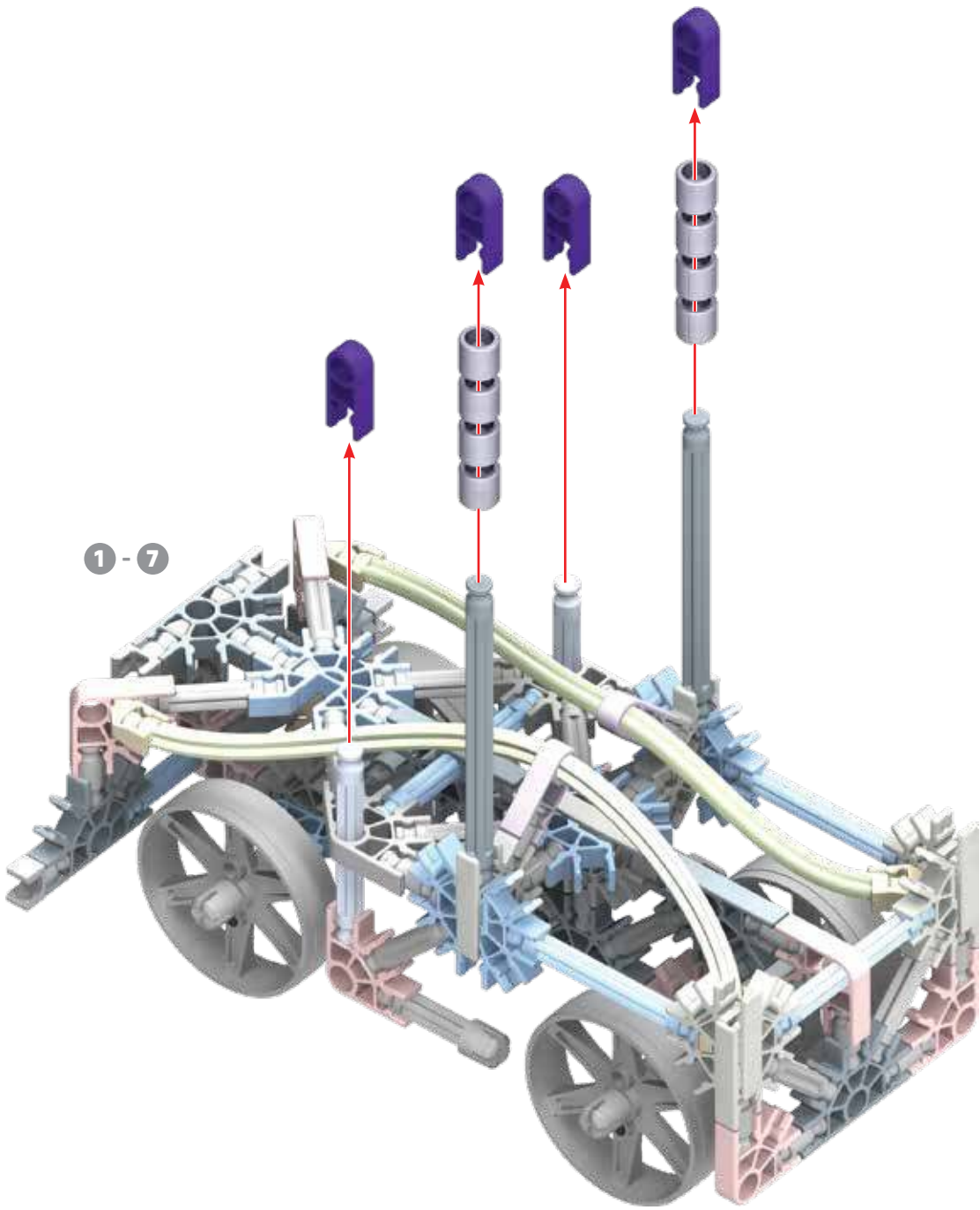

9

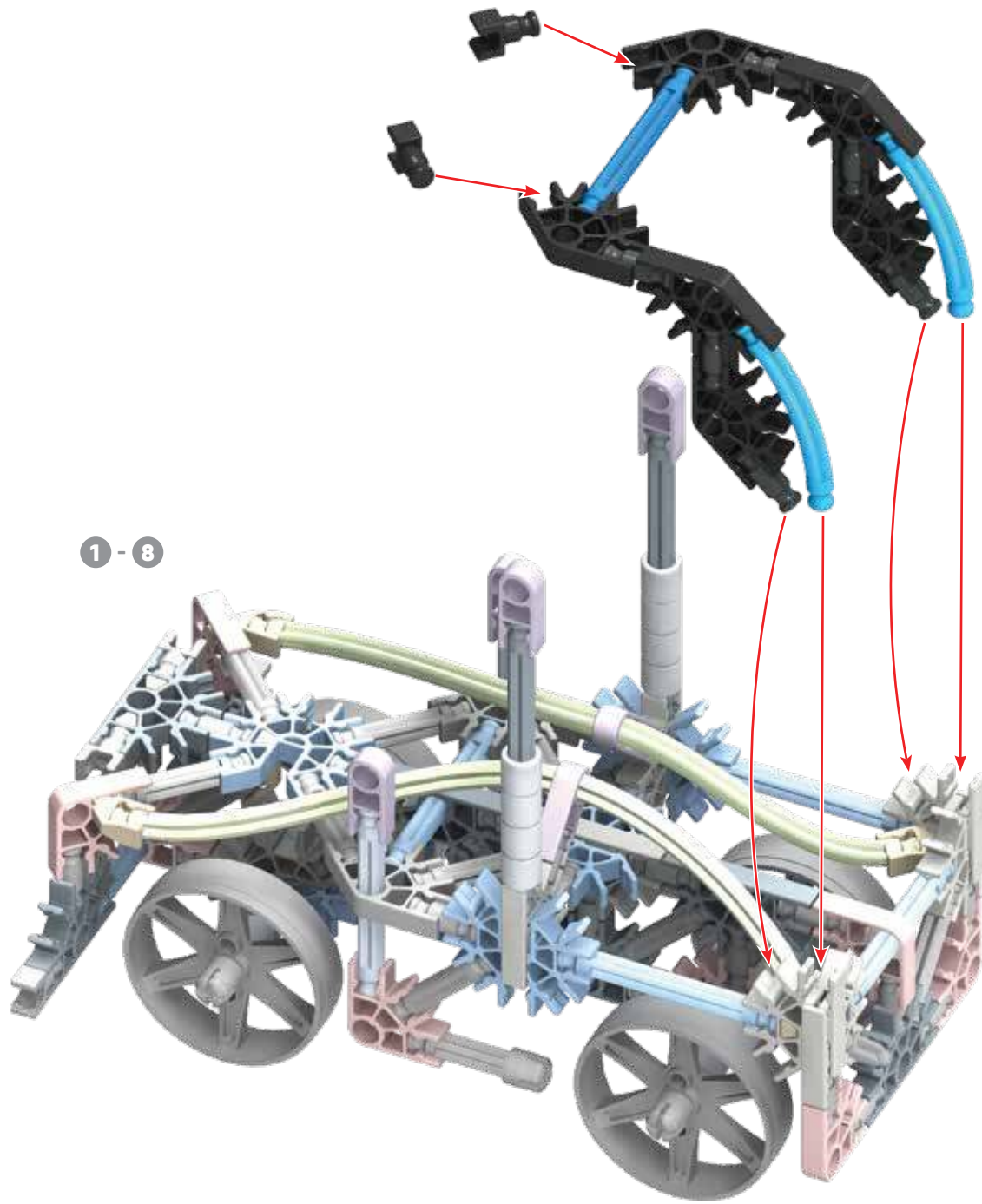

- 6 
- 1 
- 2 
- 6 
- 2 

Big Rig

1 - 9



1

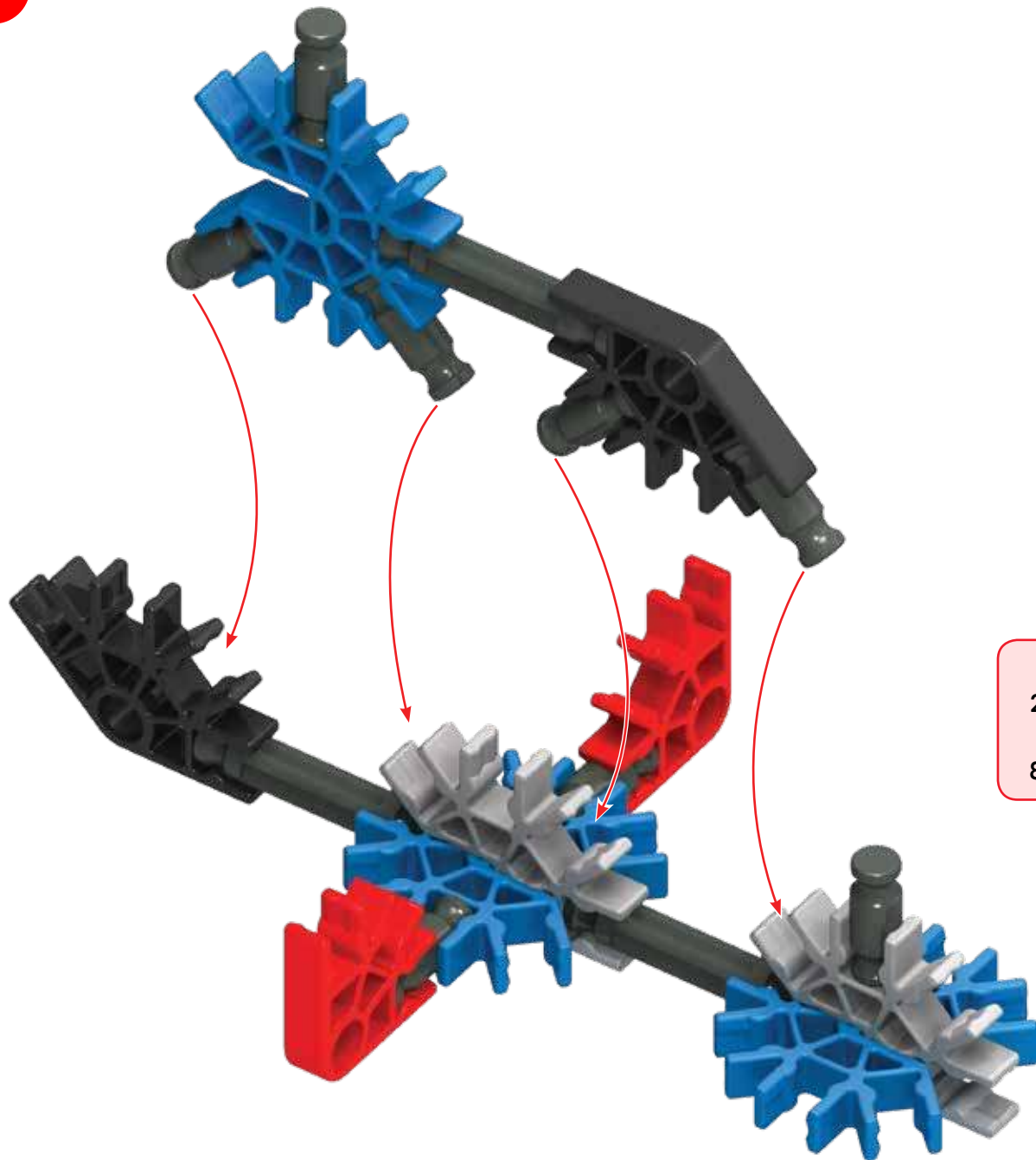

Coupe Racer



- | | | | | | | | |
|---|--|---|--|---|--|---|--|
| 2 | | 2 | | 2 | | 3 | |
| 8 | | 3 | | | | | |

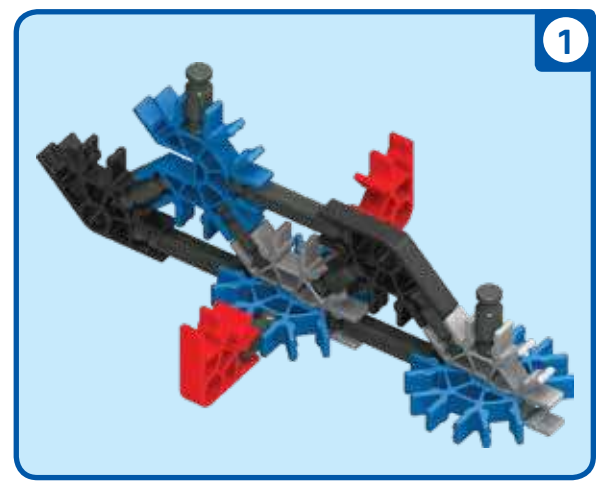

2

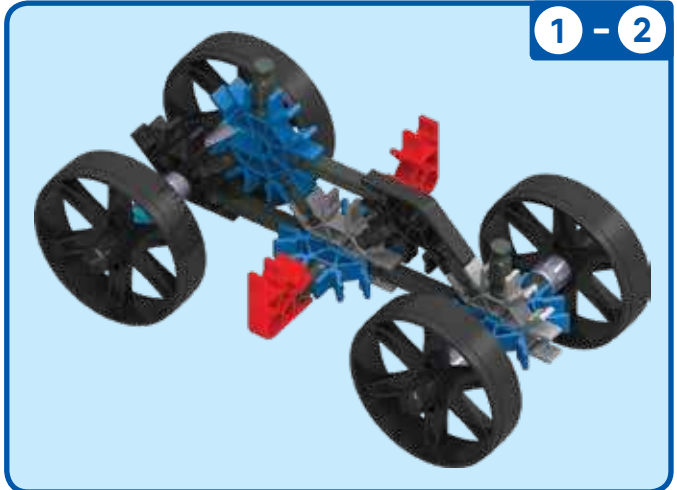
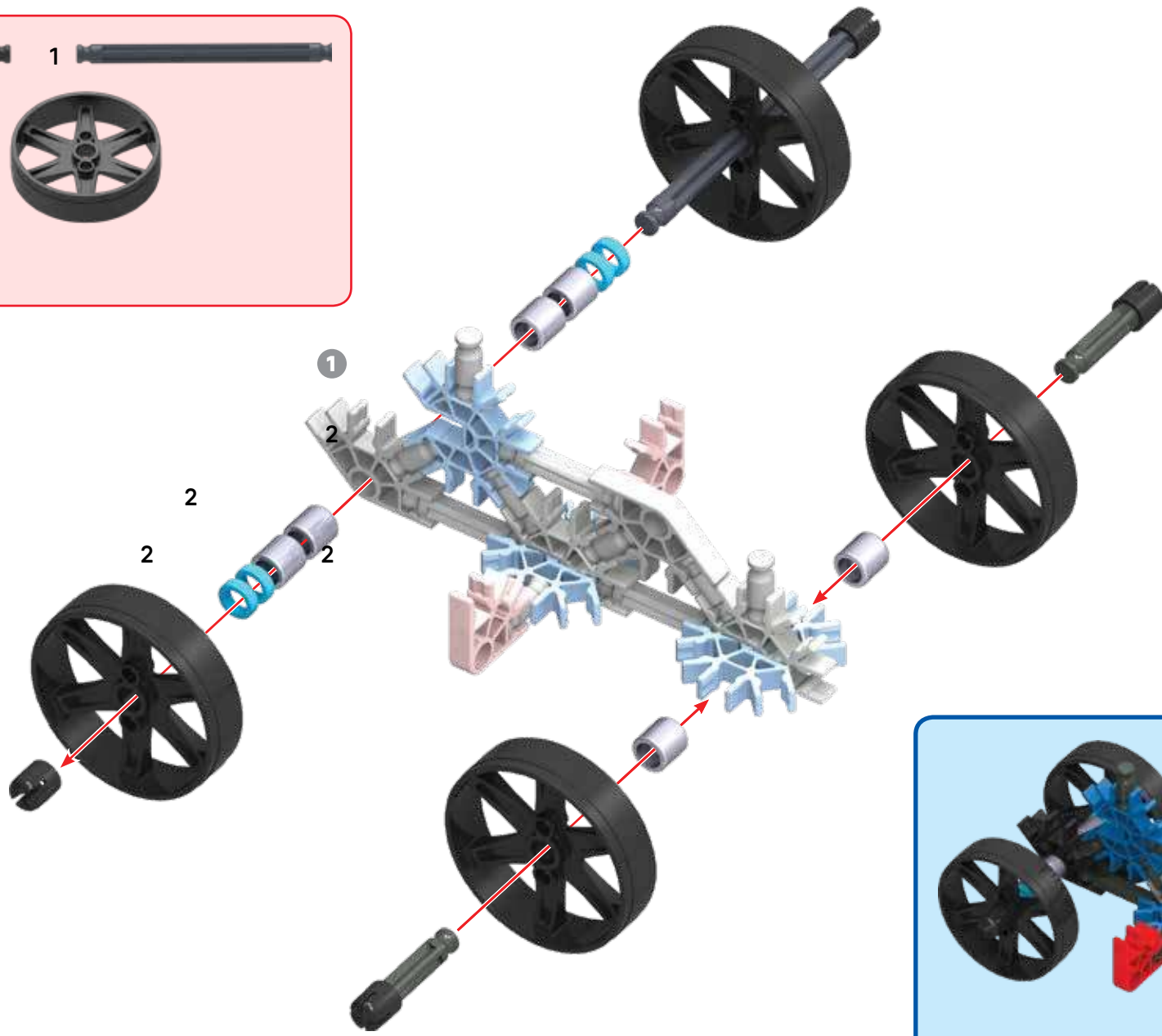
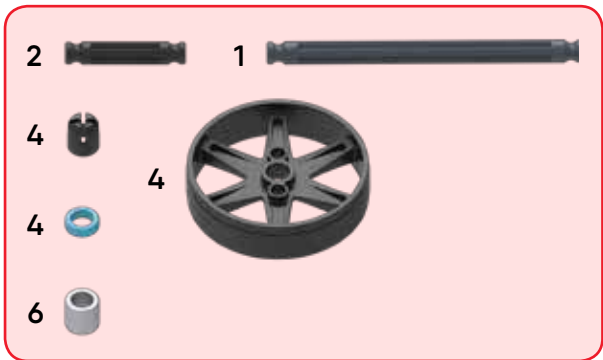

3

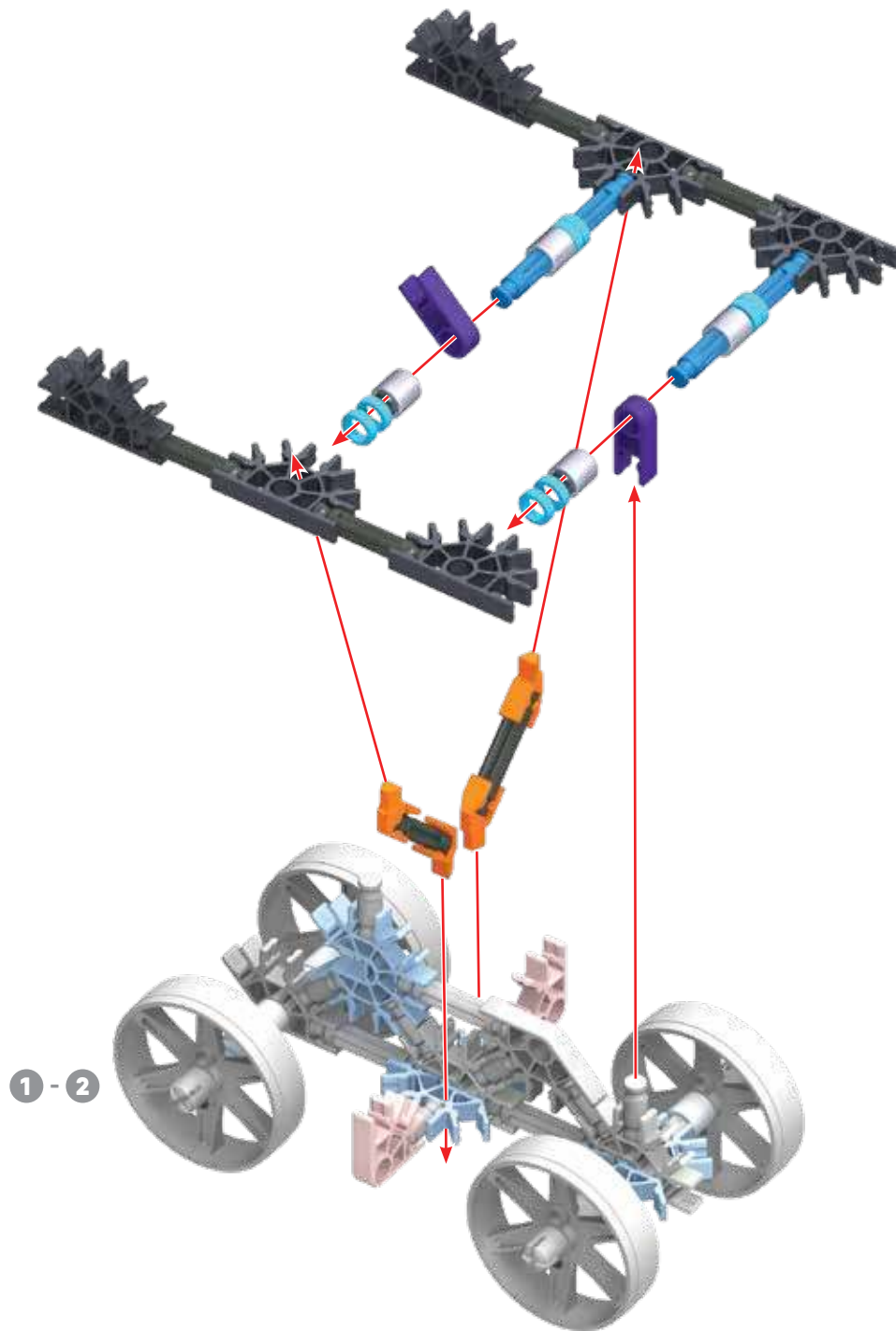

- | | | | | | | | |
|---|--|---|--|---|--|---|--|
| 6 | | 2 | | 4 | | 8 | |
| 6 | | 2 | | 4 | | | |

1 - 2

1 - 3







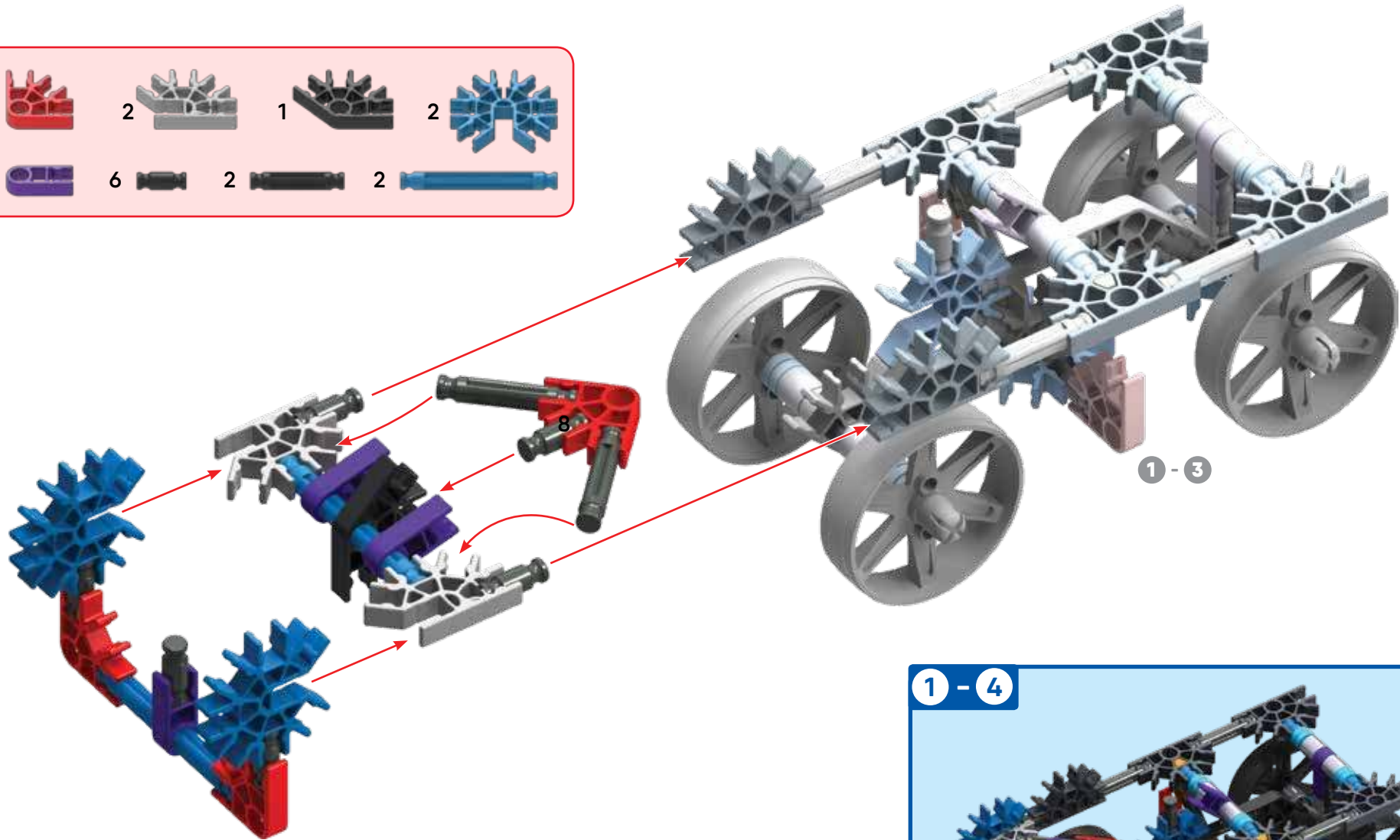

4

3	2	1	2
3	6	2	2



5

- 2 
- 4 
- 4 
- 2 
- 4 
- 2 
- 1 

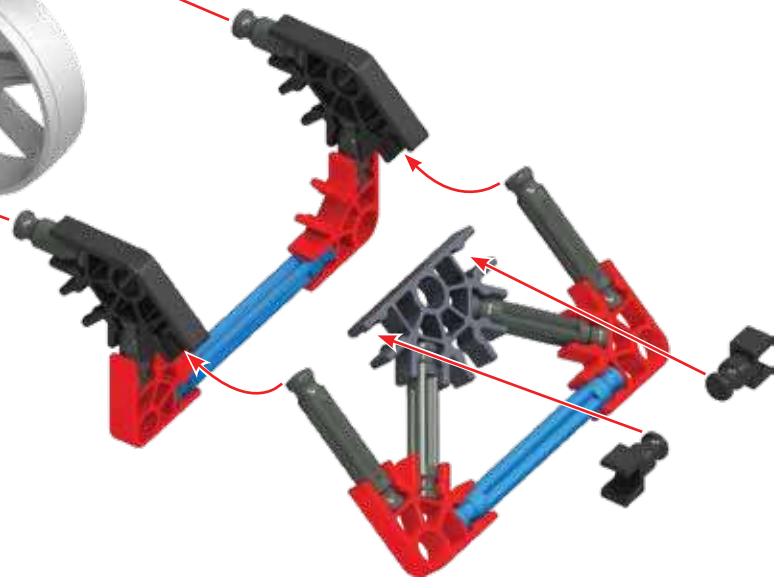
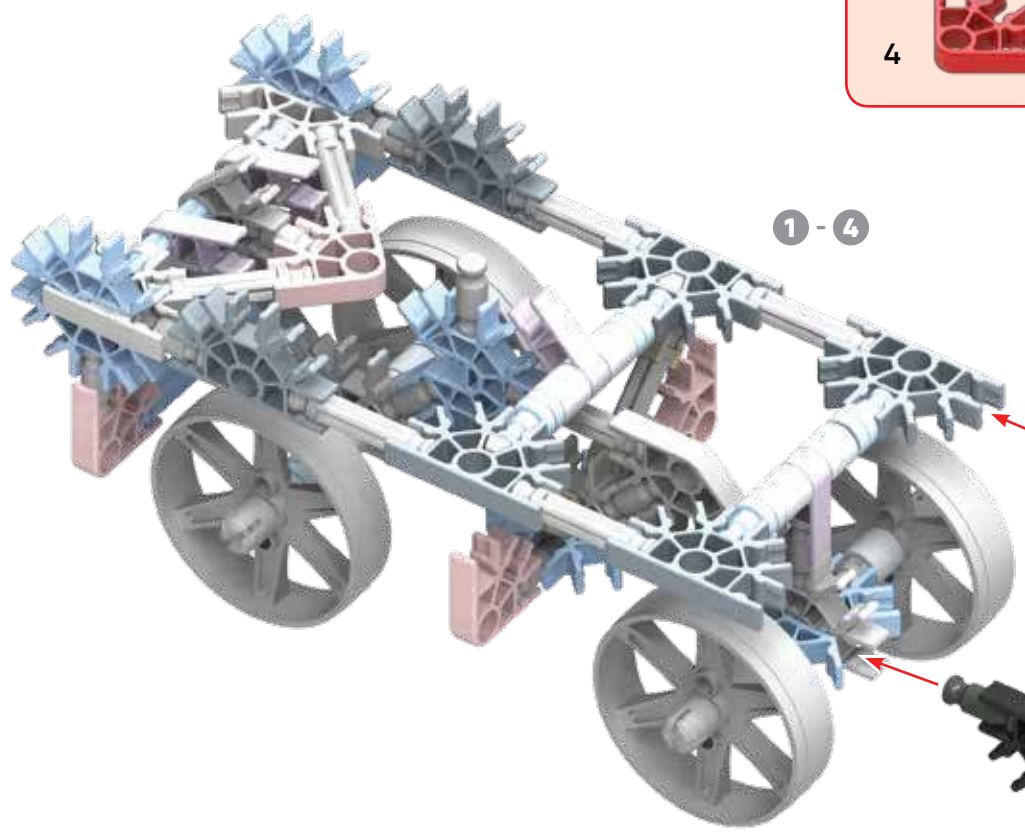

6

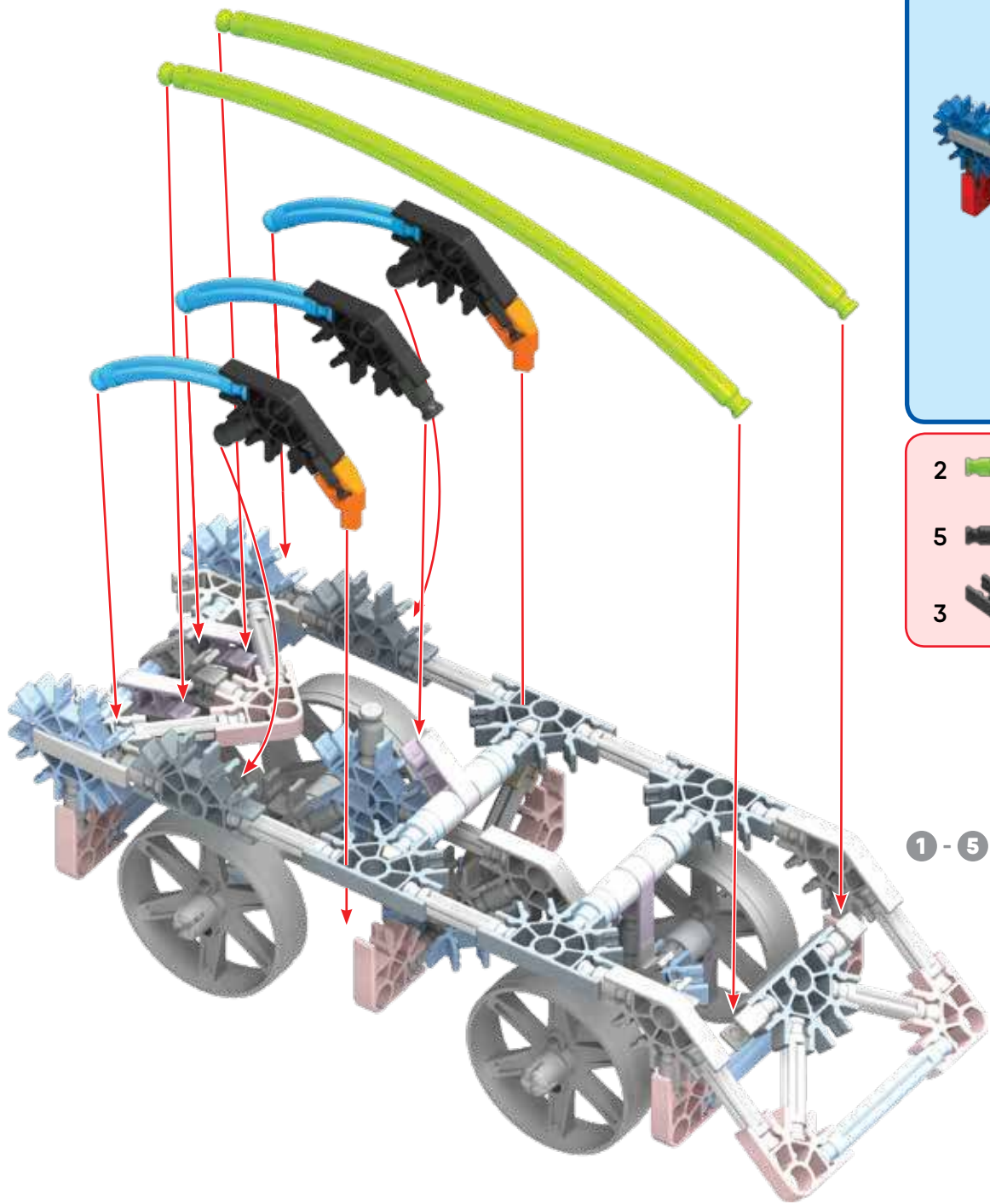

1 - 6

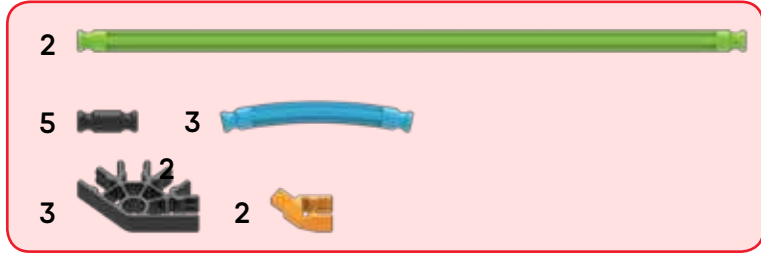

1 - 5



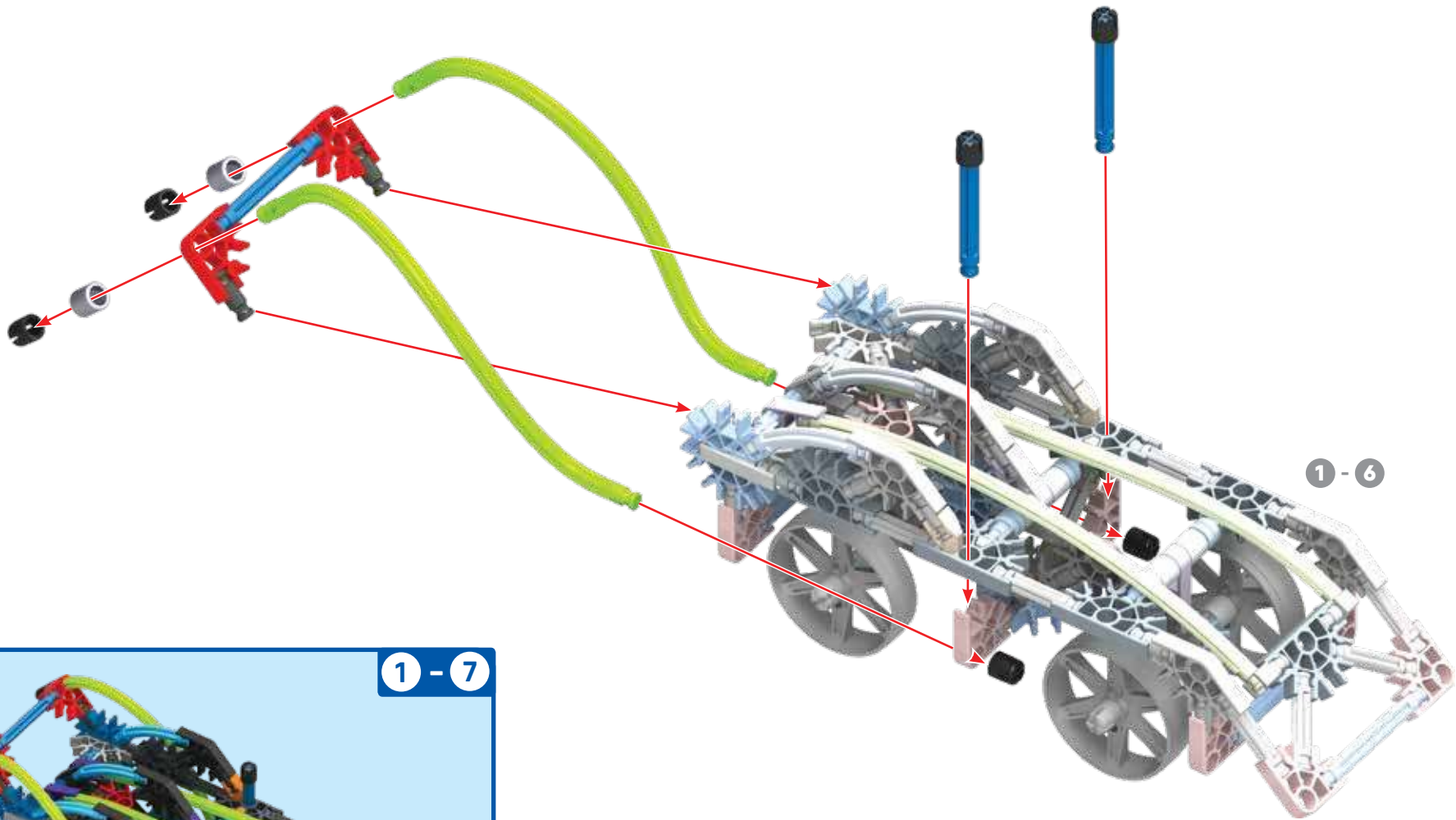

7



1 - 7







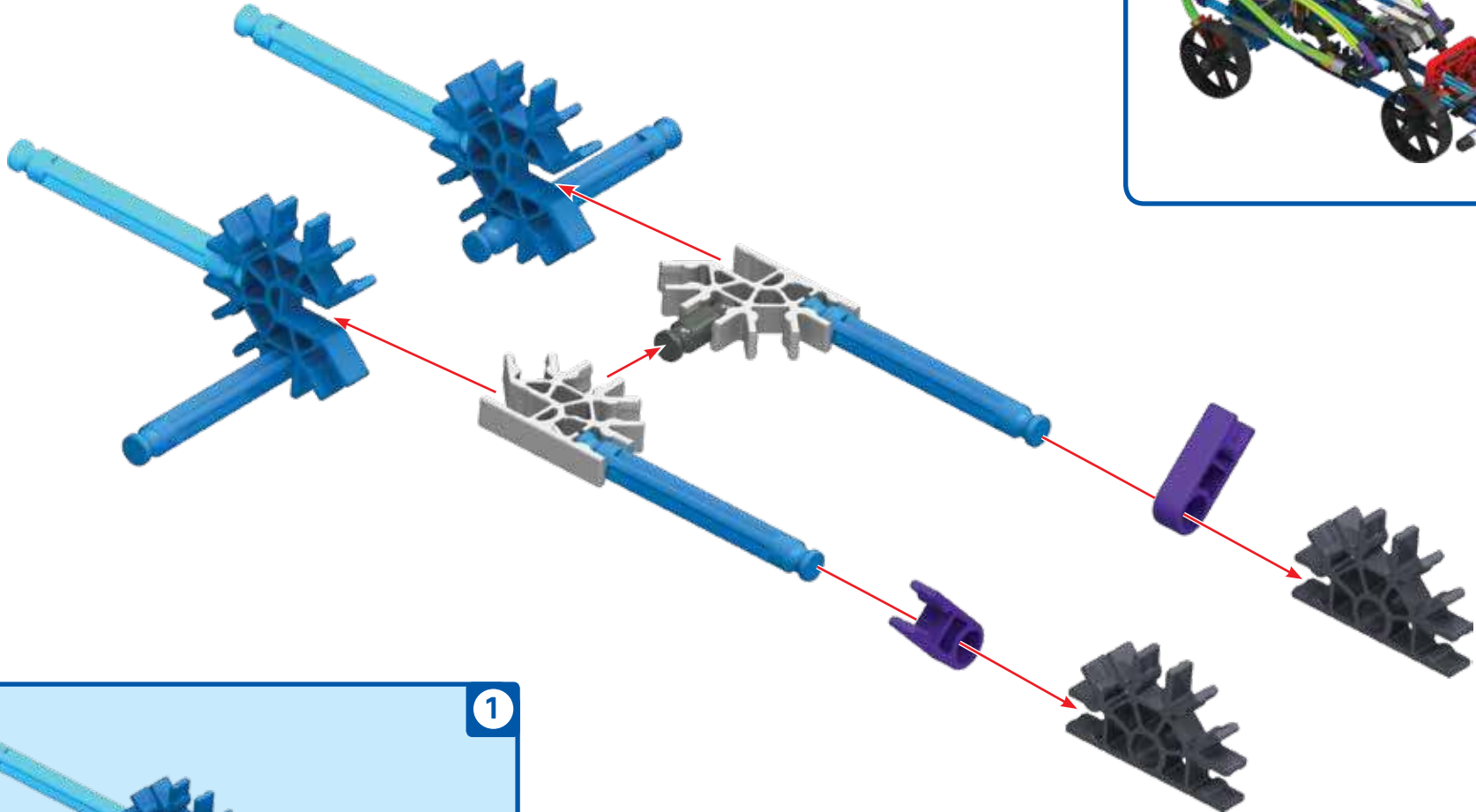

Coupe Racer

- 2 
- 2  3 
- 2  2  6 

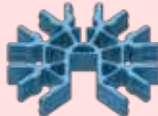
1

Hot Rod



- 2 
- 2 
- 2 
- 2 
- 1 
- 4 
- 2 

2

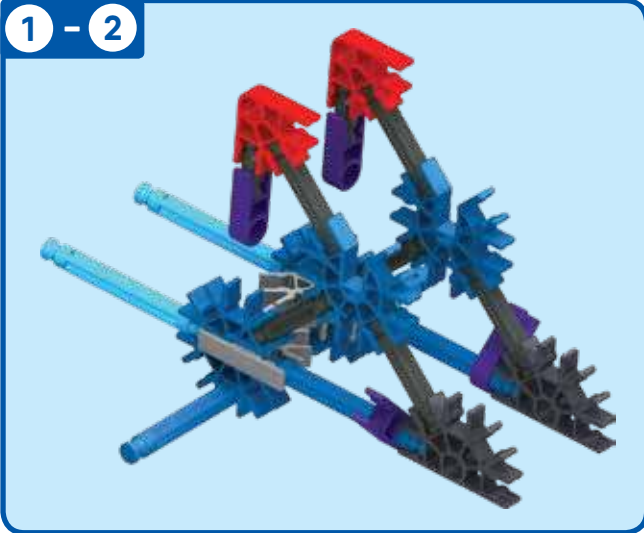
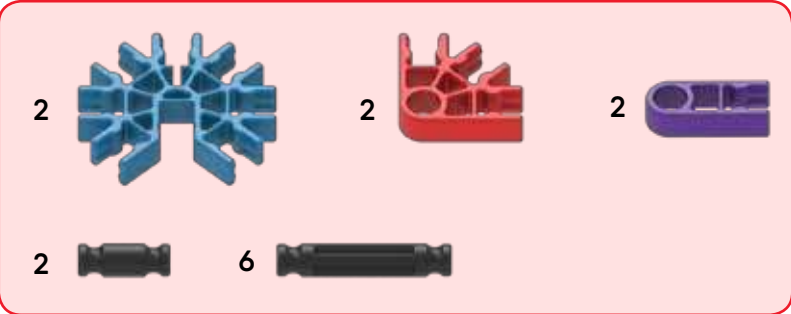
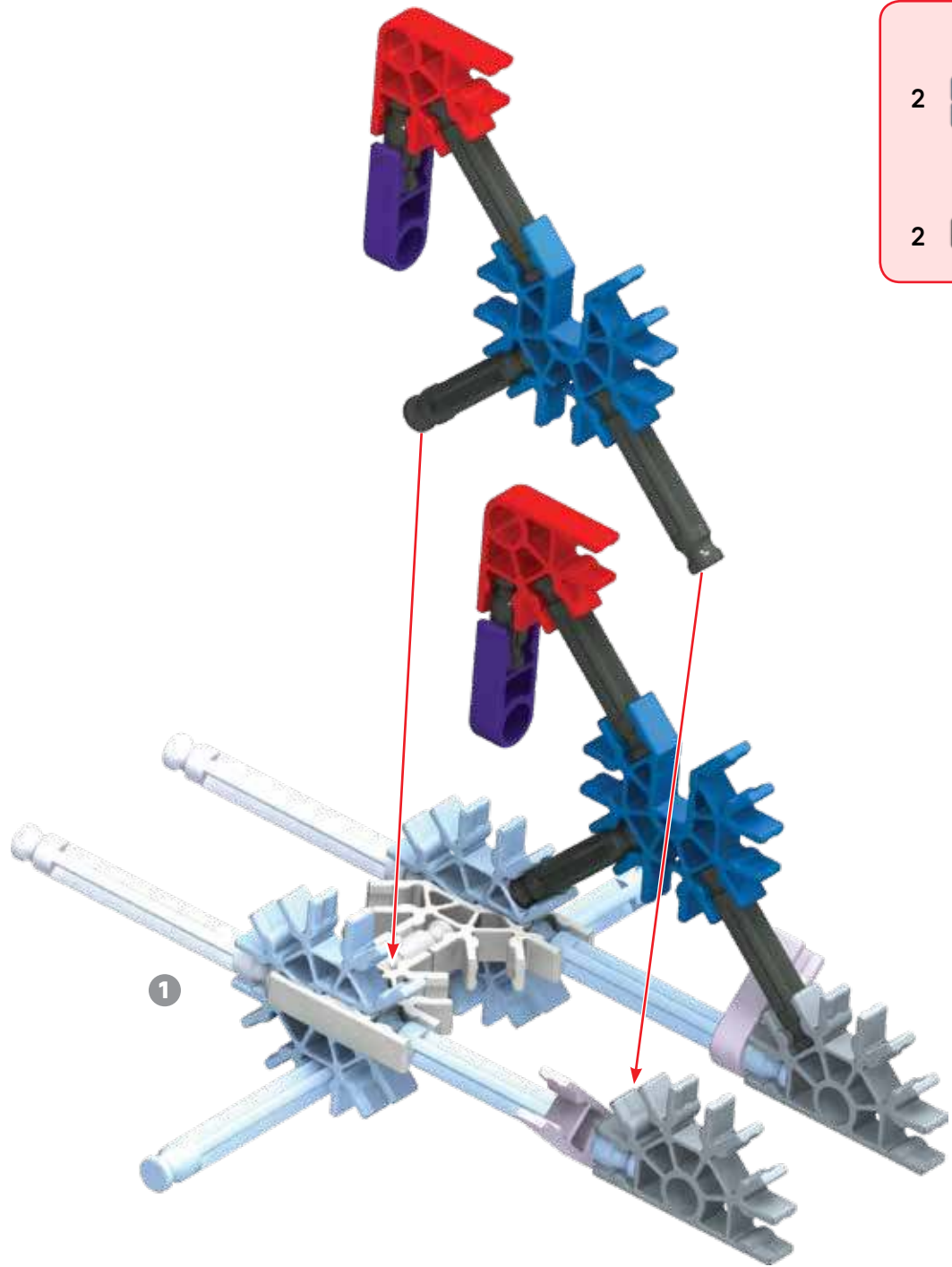

3

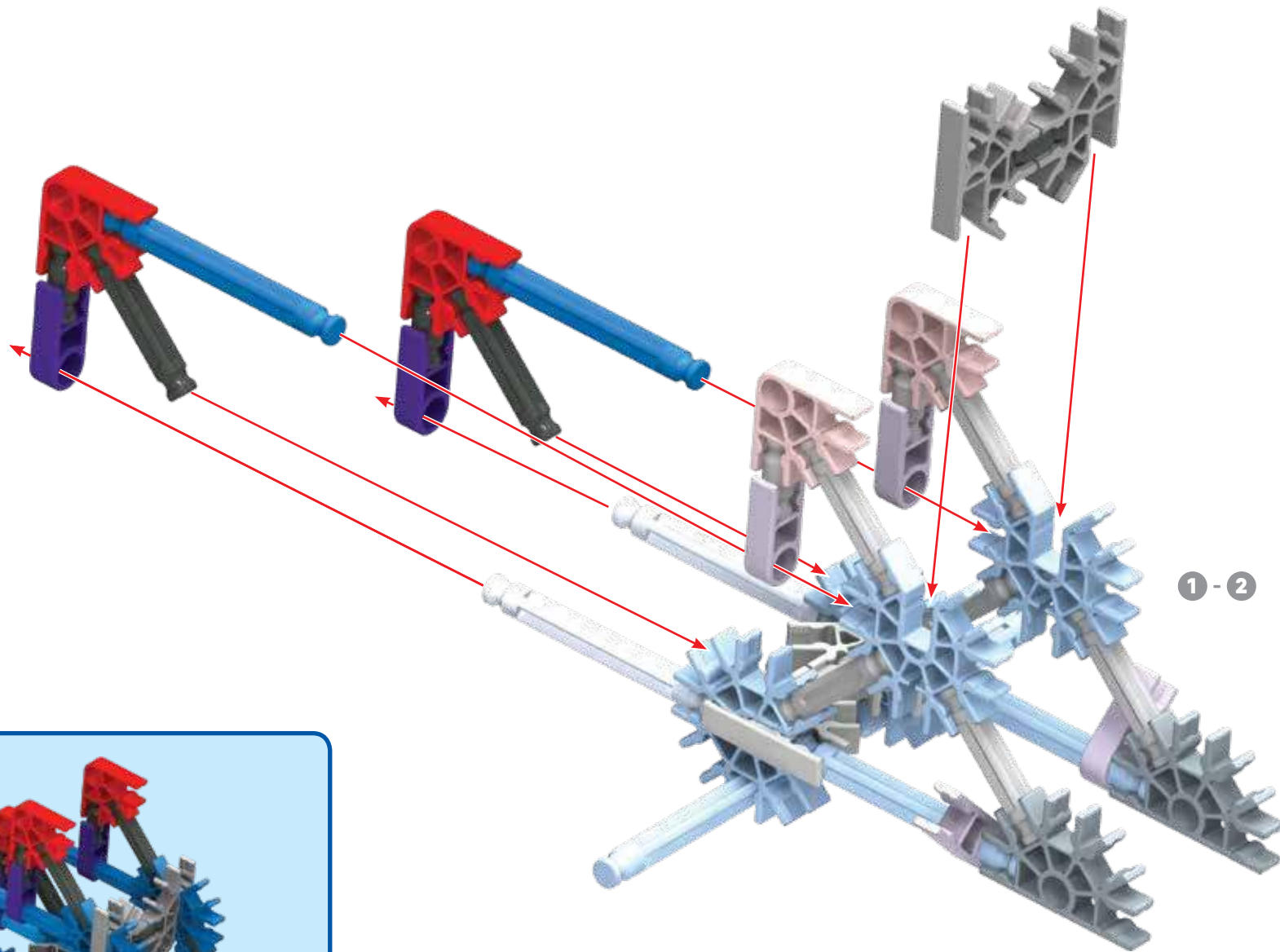

1 - 3

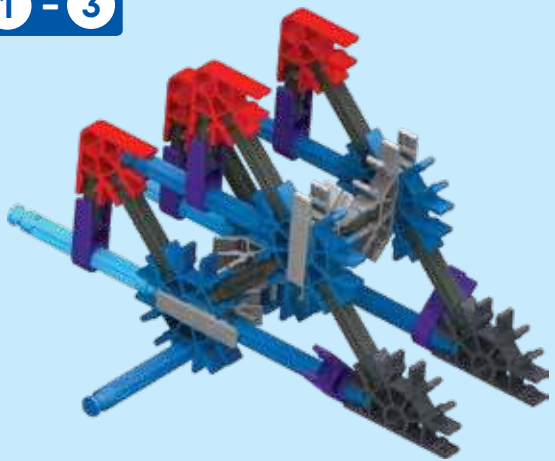

- | | | | | | |
|---|--|---|--|---|--|
| 3 | | 2 | | 2 | |
| 2 | | 2 | | 2 | |

4

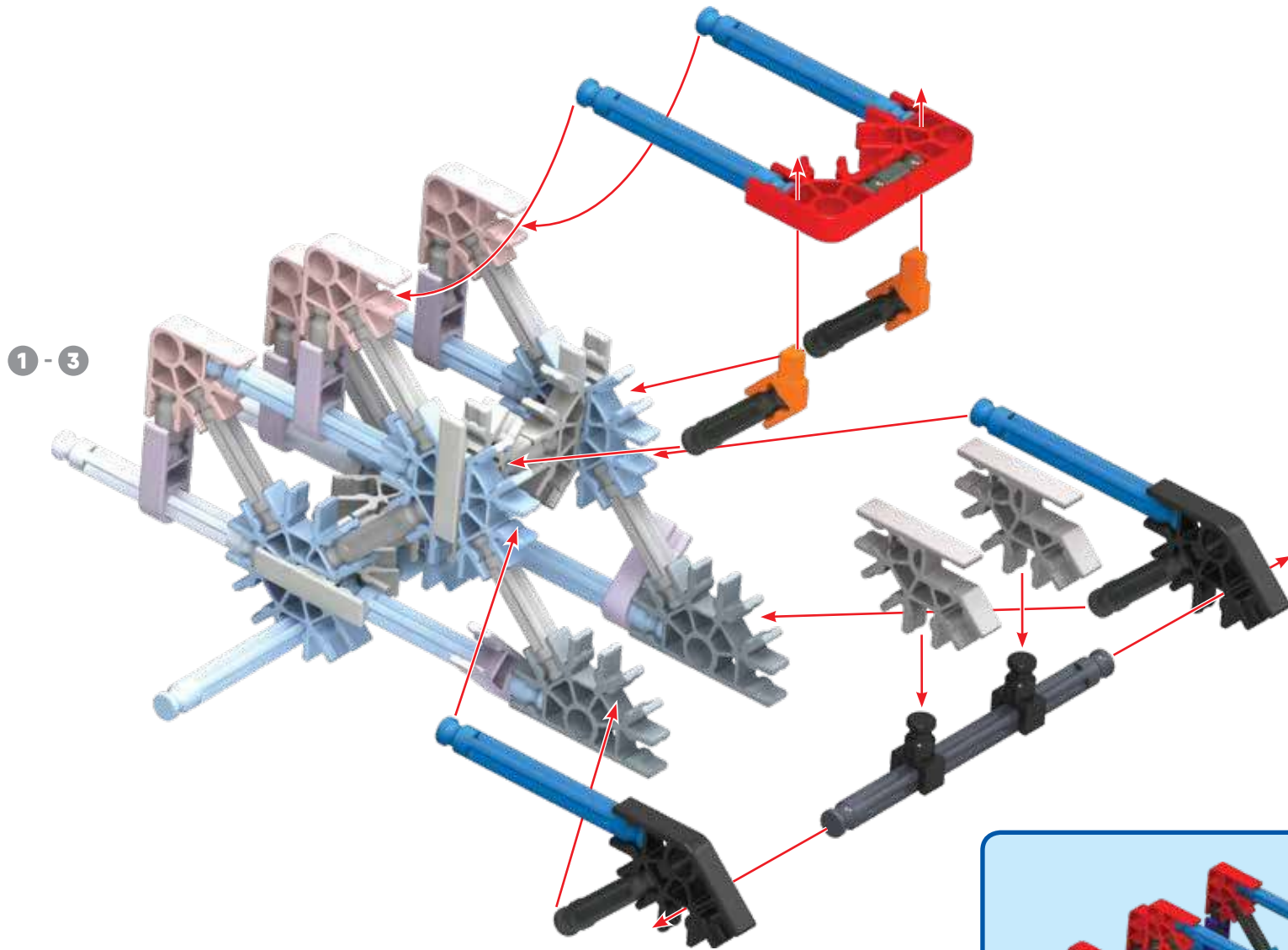

- 2
- 2
- 2
- 2
- 2
- 1
- 4
- 4
- 1

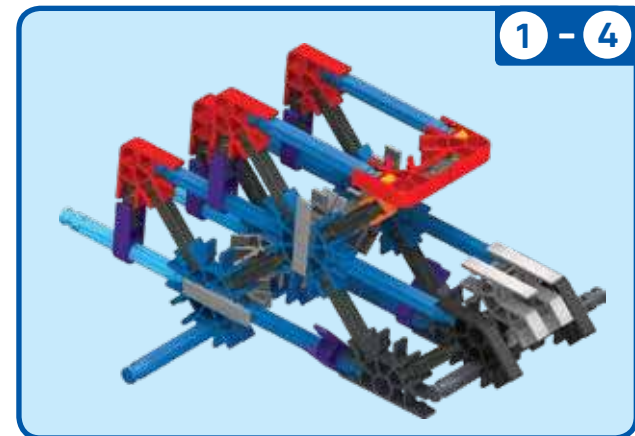





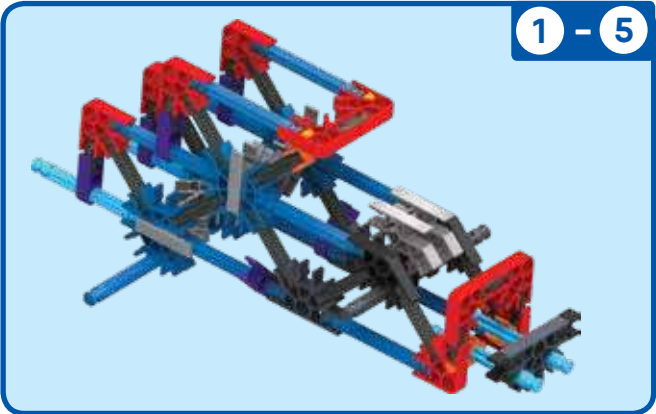
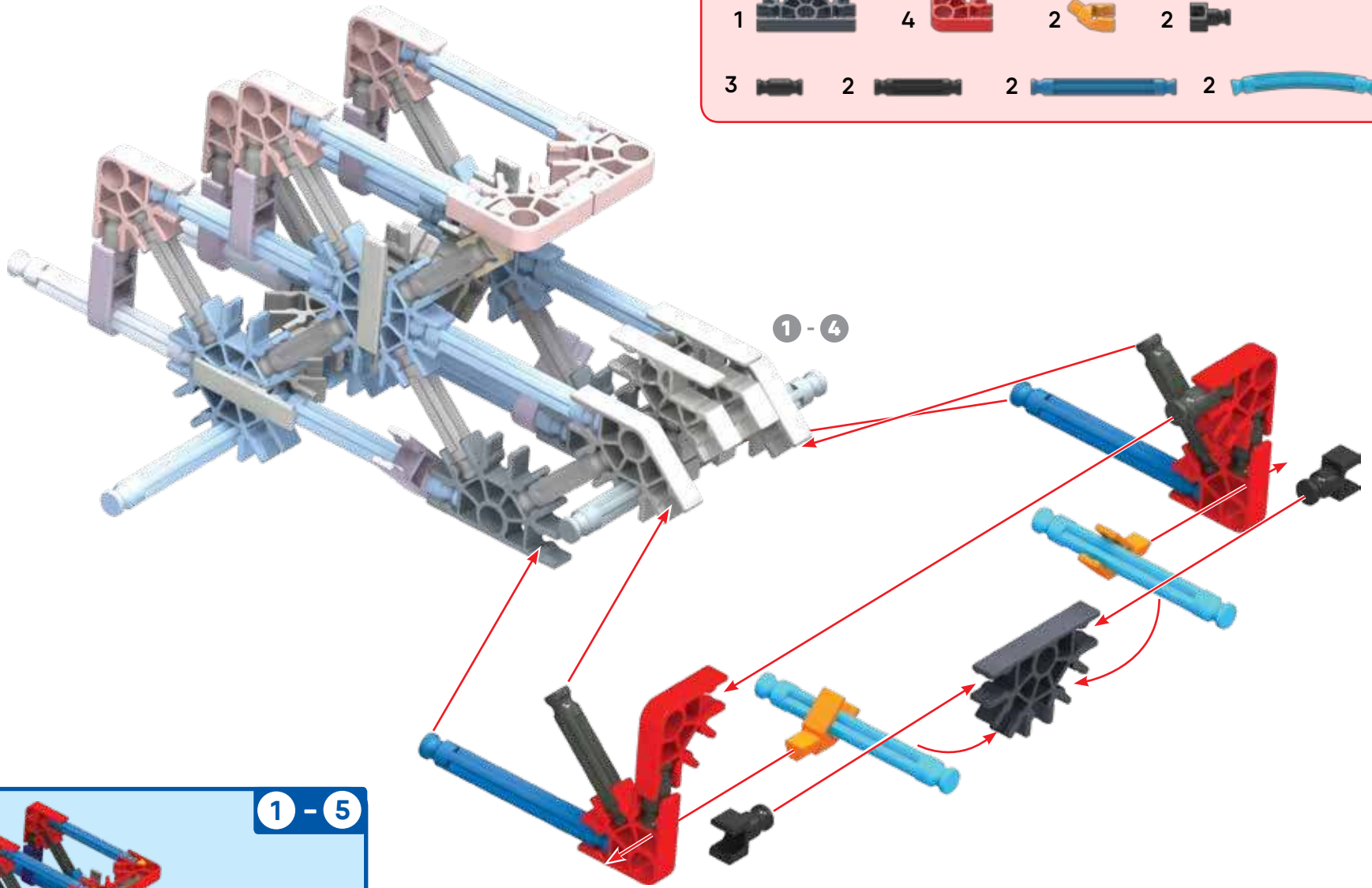



5

- 1
- 4
- 2
- 2
- 3
- 2
- 2
- 2



6

- 4 
- 2 
- 4 
- 5 
- 2 
- 2 
- 2 
- 1 

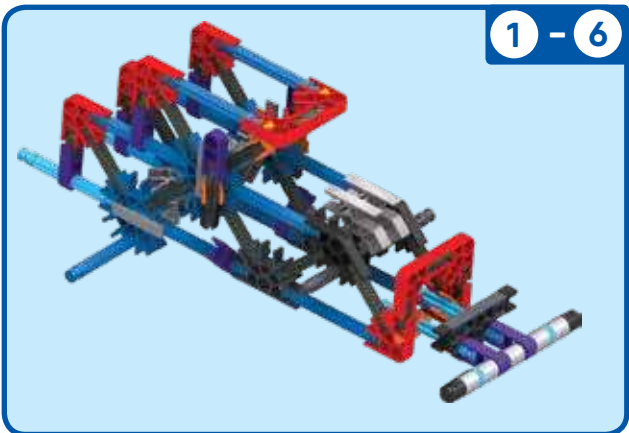
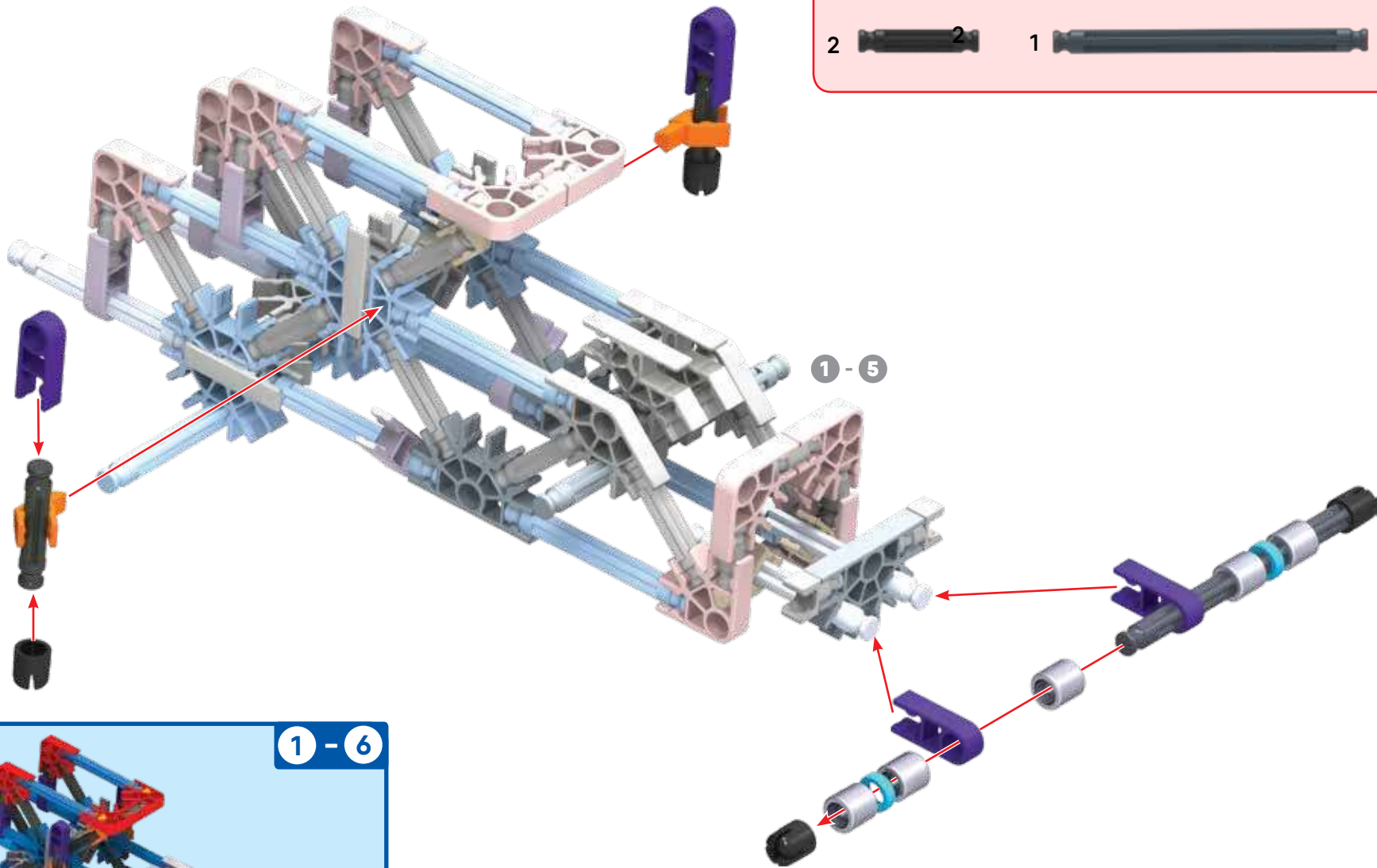

7

Rotate model

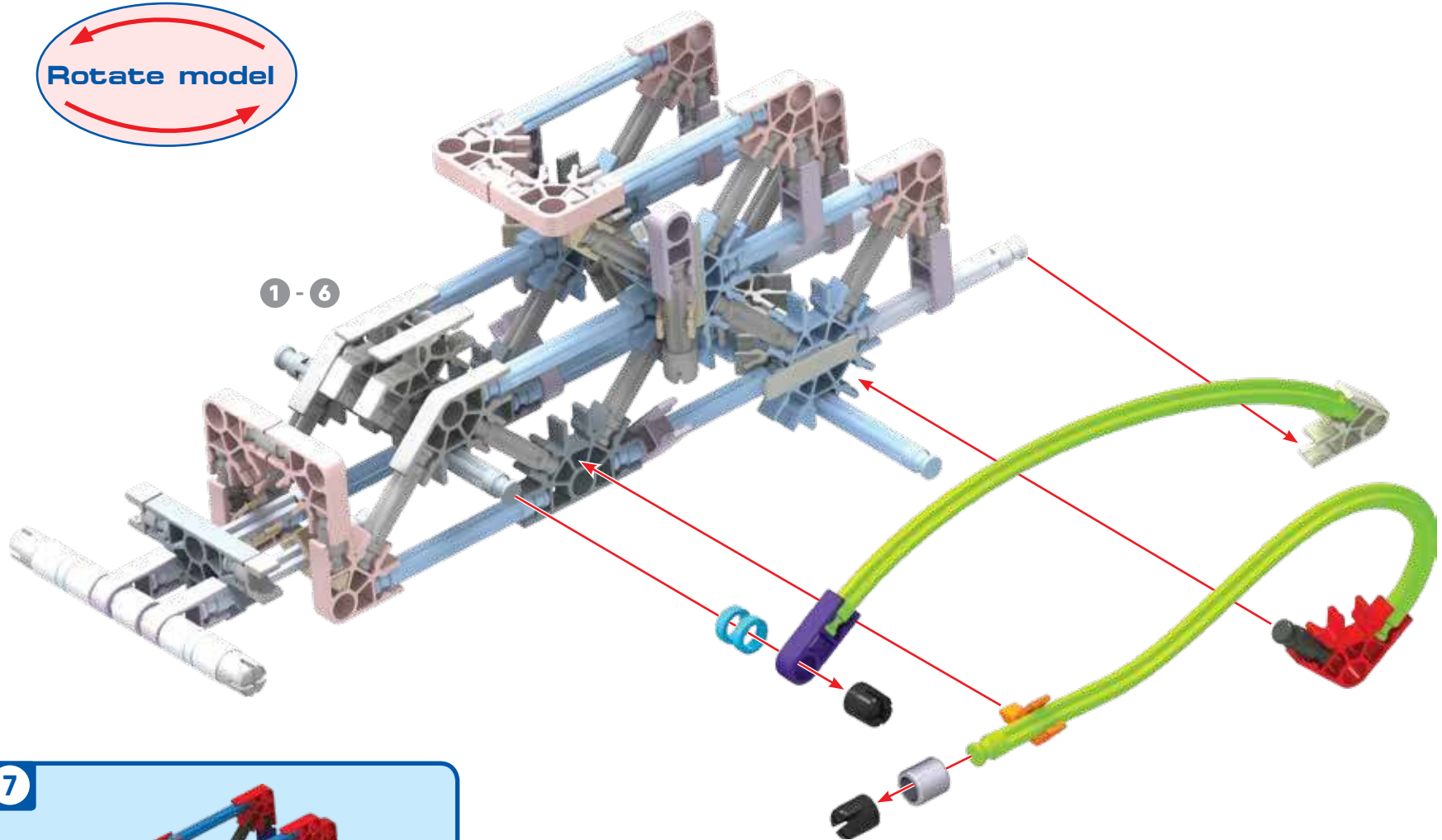

1 - 7



- | | | | | | | | |
|---|--|---|--|---|--|---|--|
| 2 | | | | | | | |
| 1 | | 1 | | 1 | | 1 | |
| 1 | | 1 | | 2 | | 2 | |

8

Rotate model

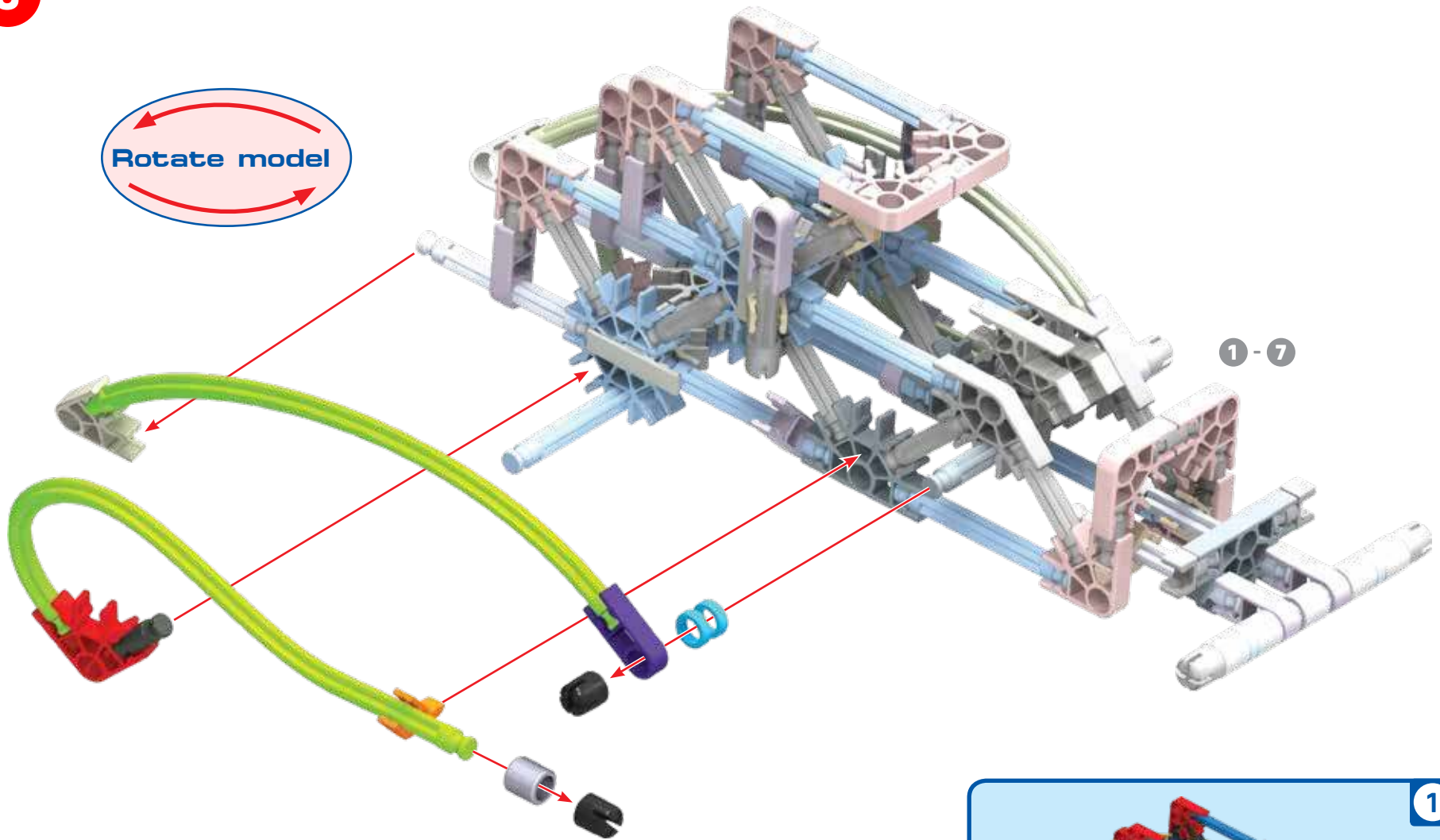

1-7

- 2
- 1
- 1
- 1
- 1
- 1
- 1
- 2
- 2

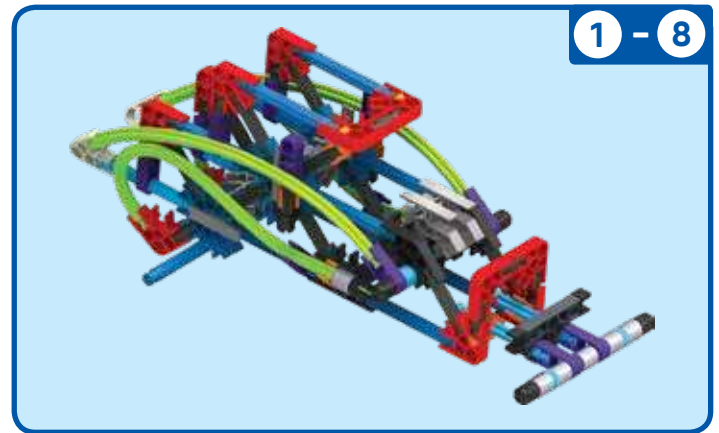

1-8

9

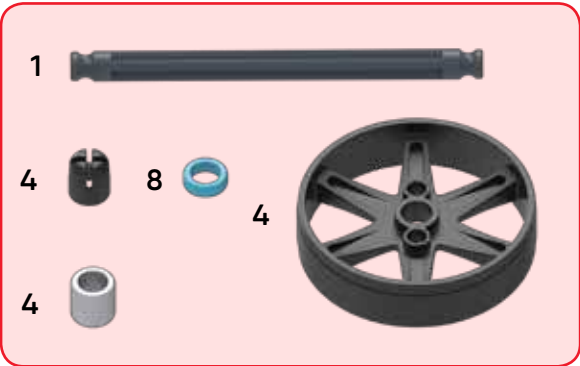
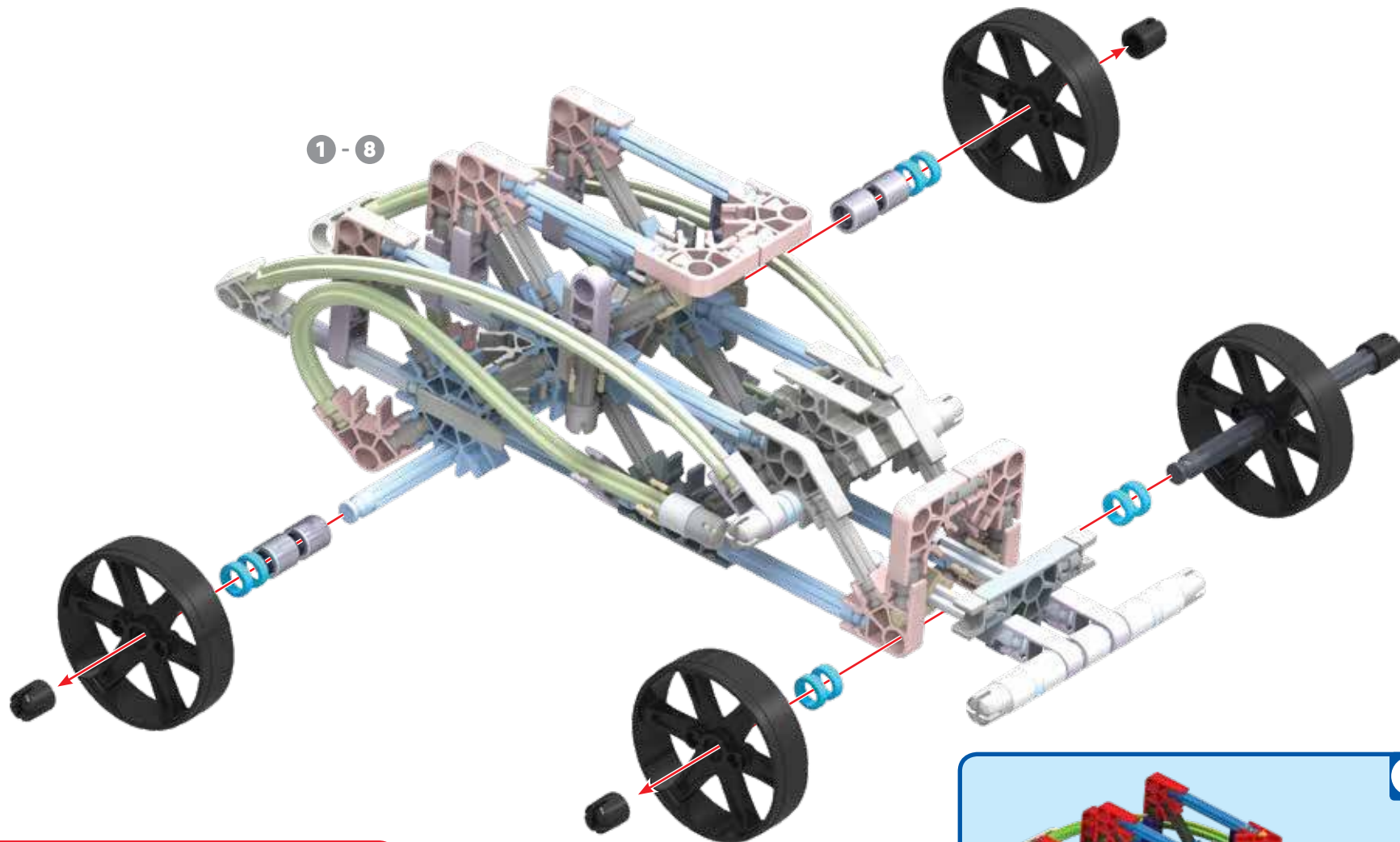

1

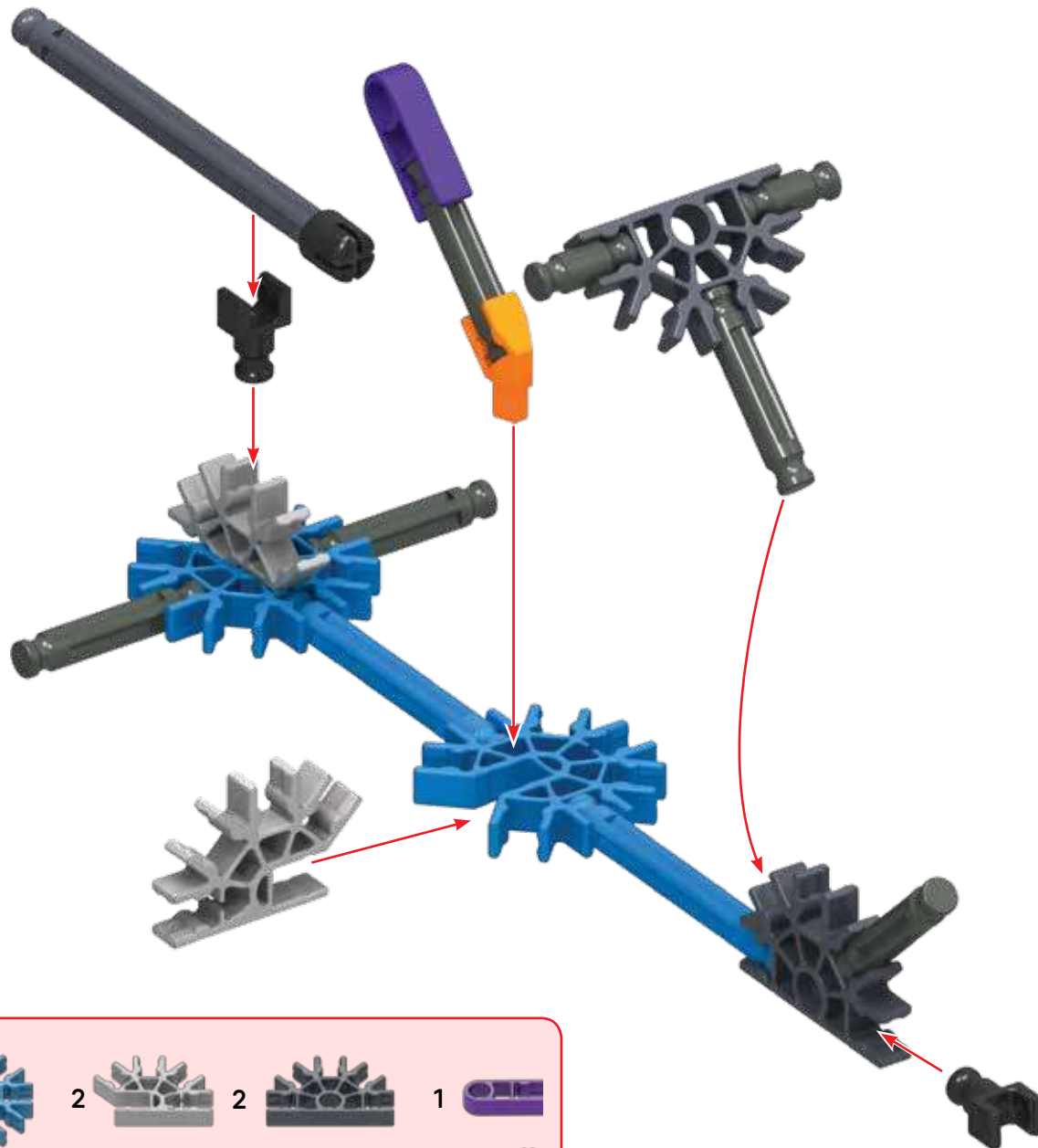

- 2
- 2
- 2
- 1
- 2
- 5
- 2
- 1
- 1
- 1
- 2



2

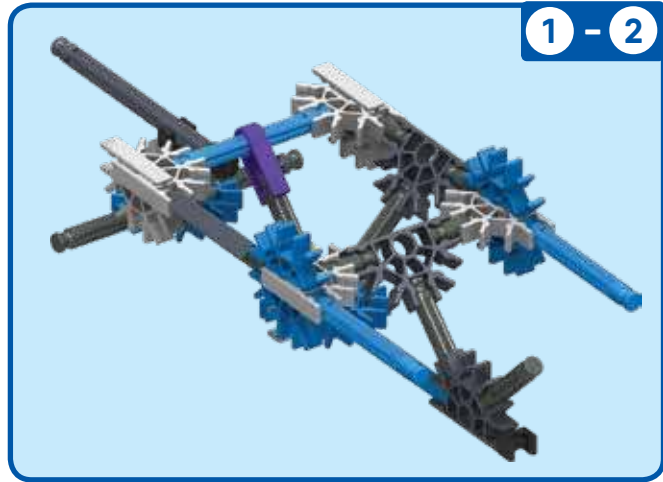
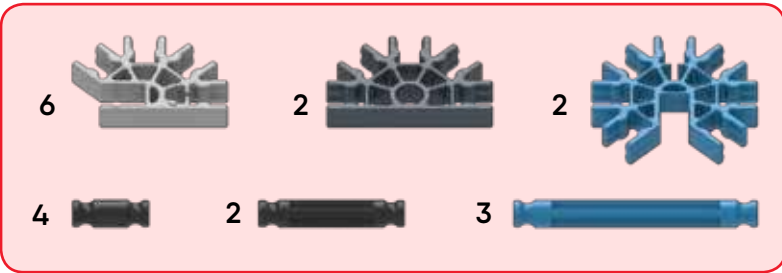
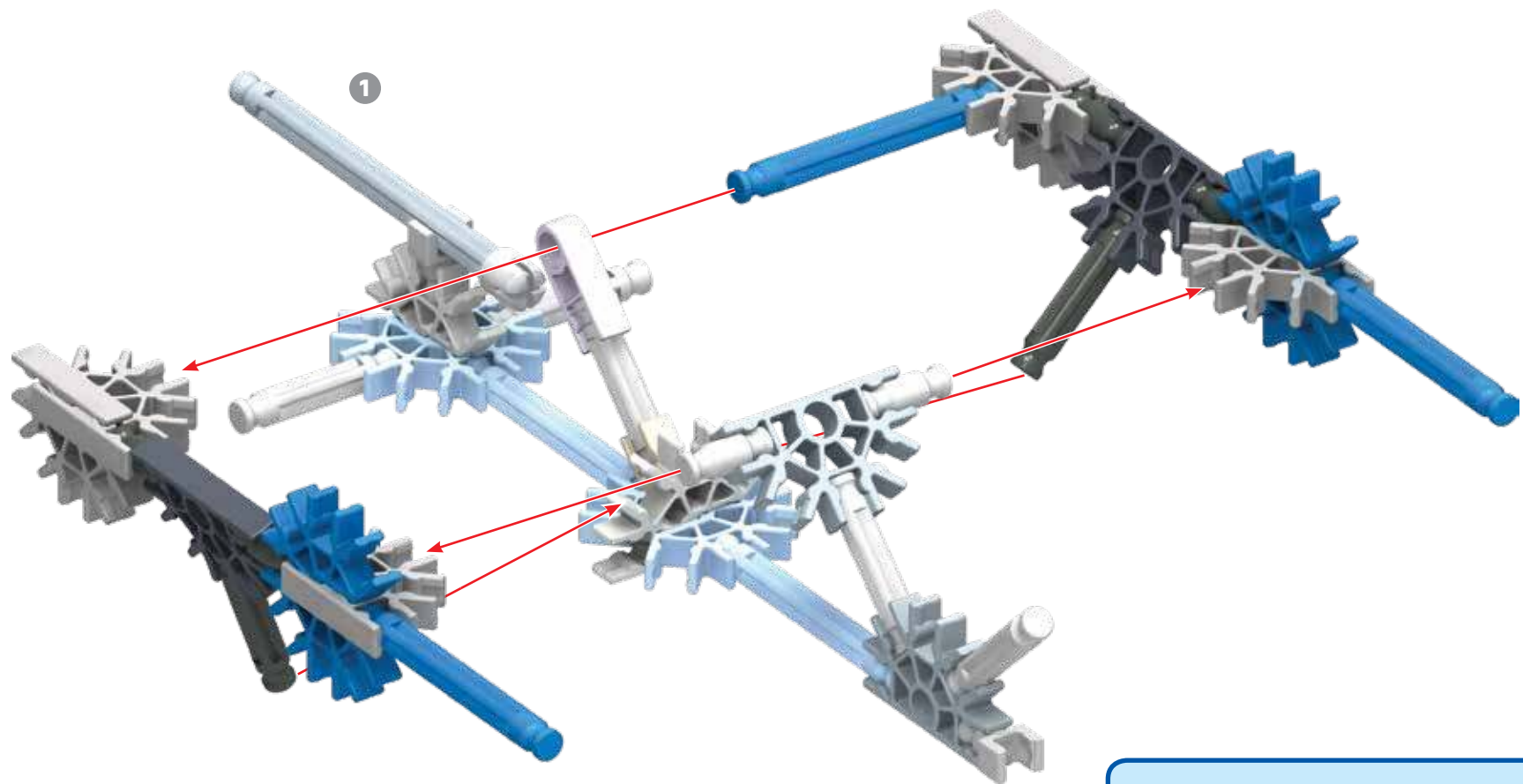

3

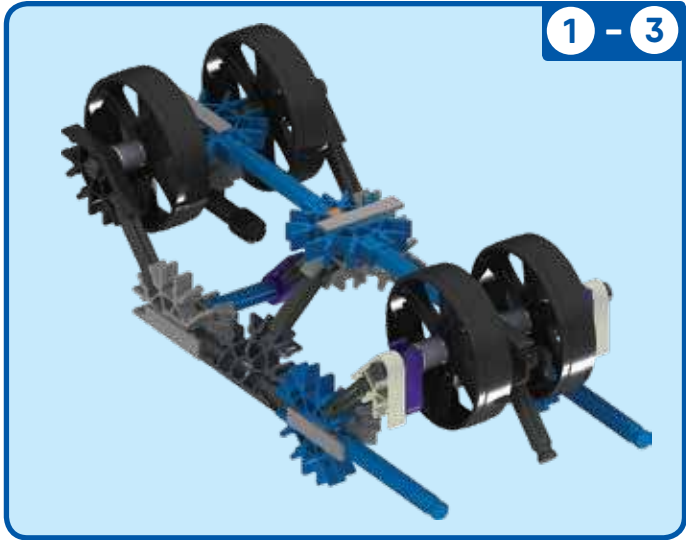
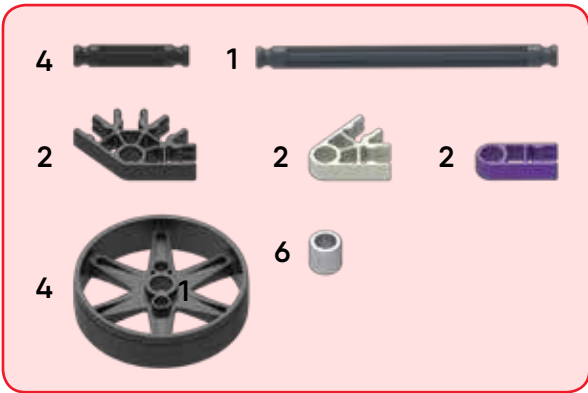
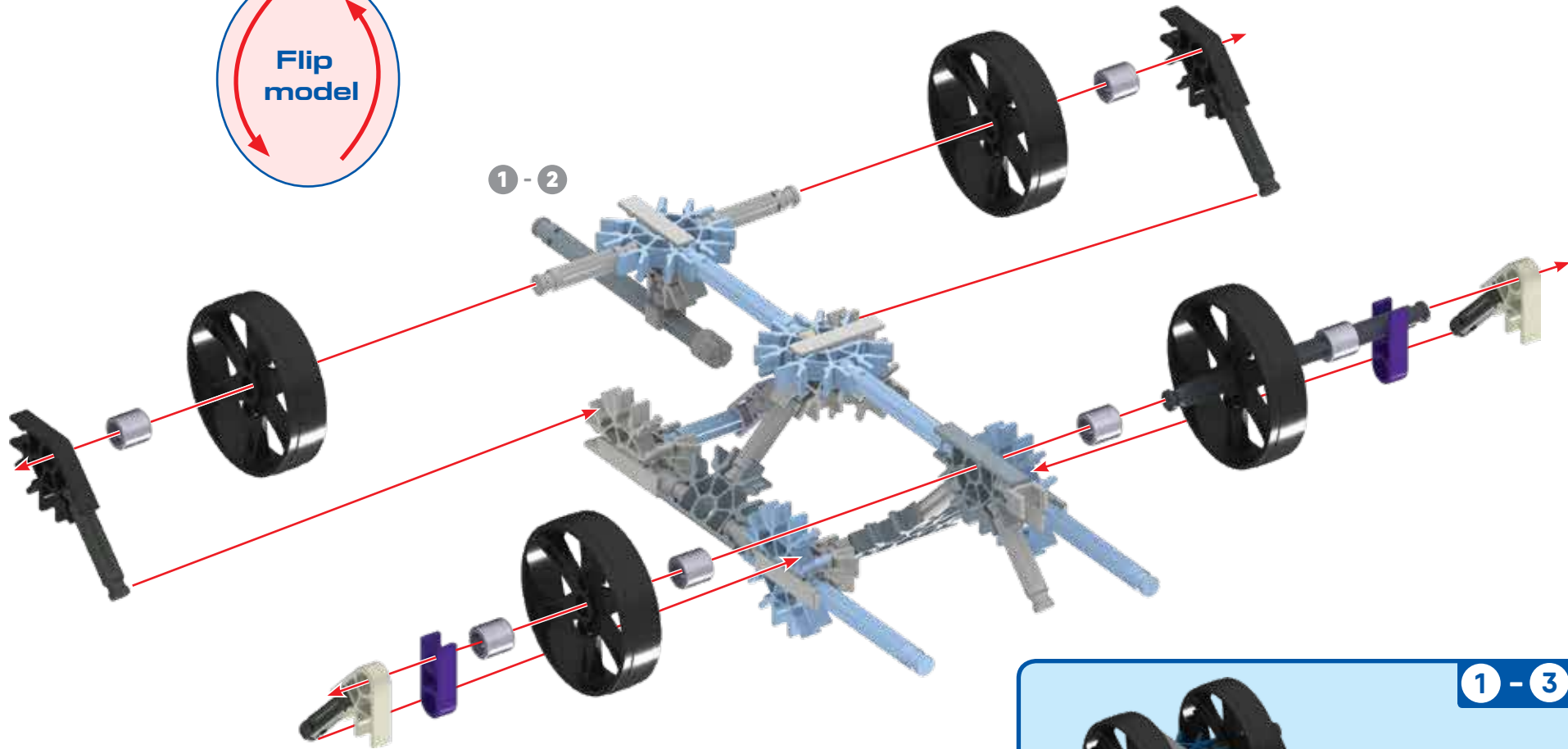
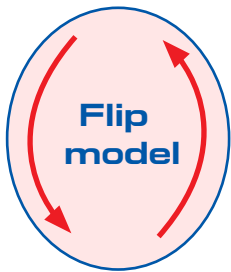

4

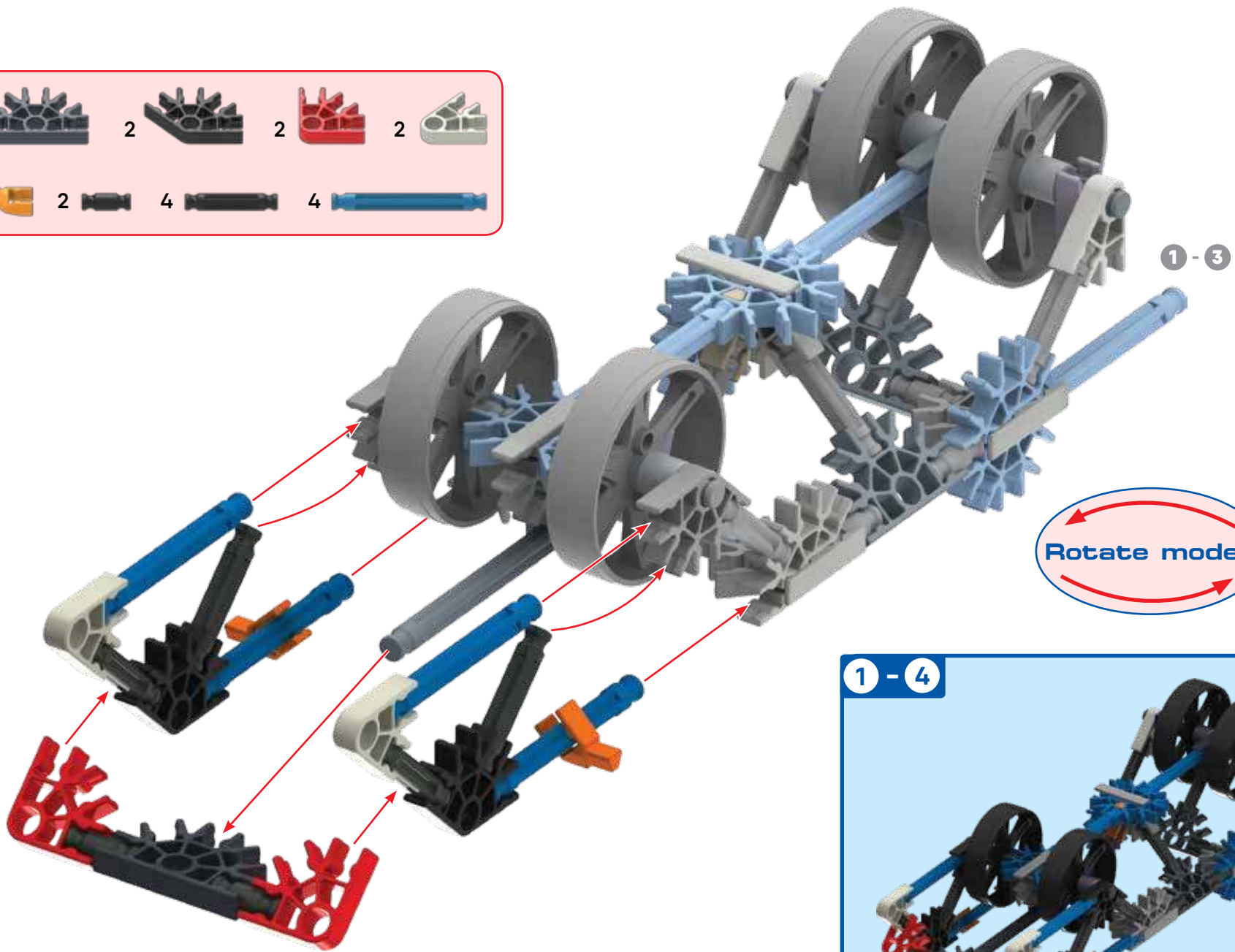
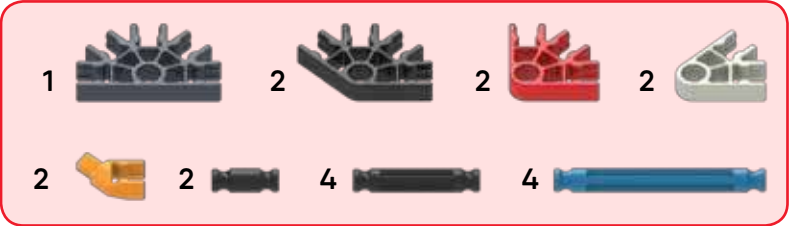

5

- 1
- 2
- 5
- 4
- 6
- 2
- 2

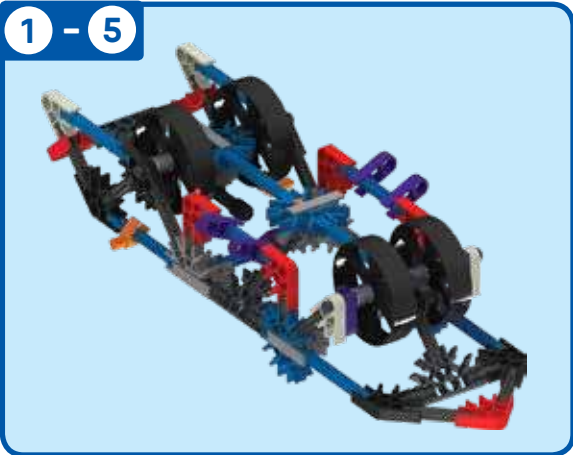
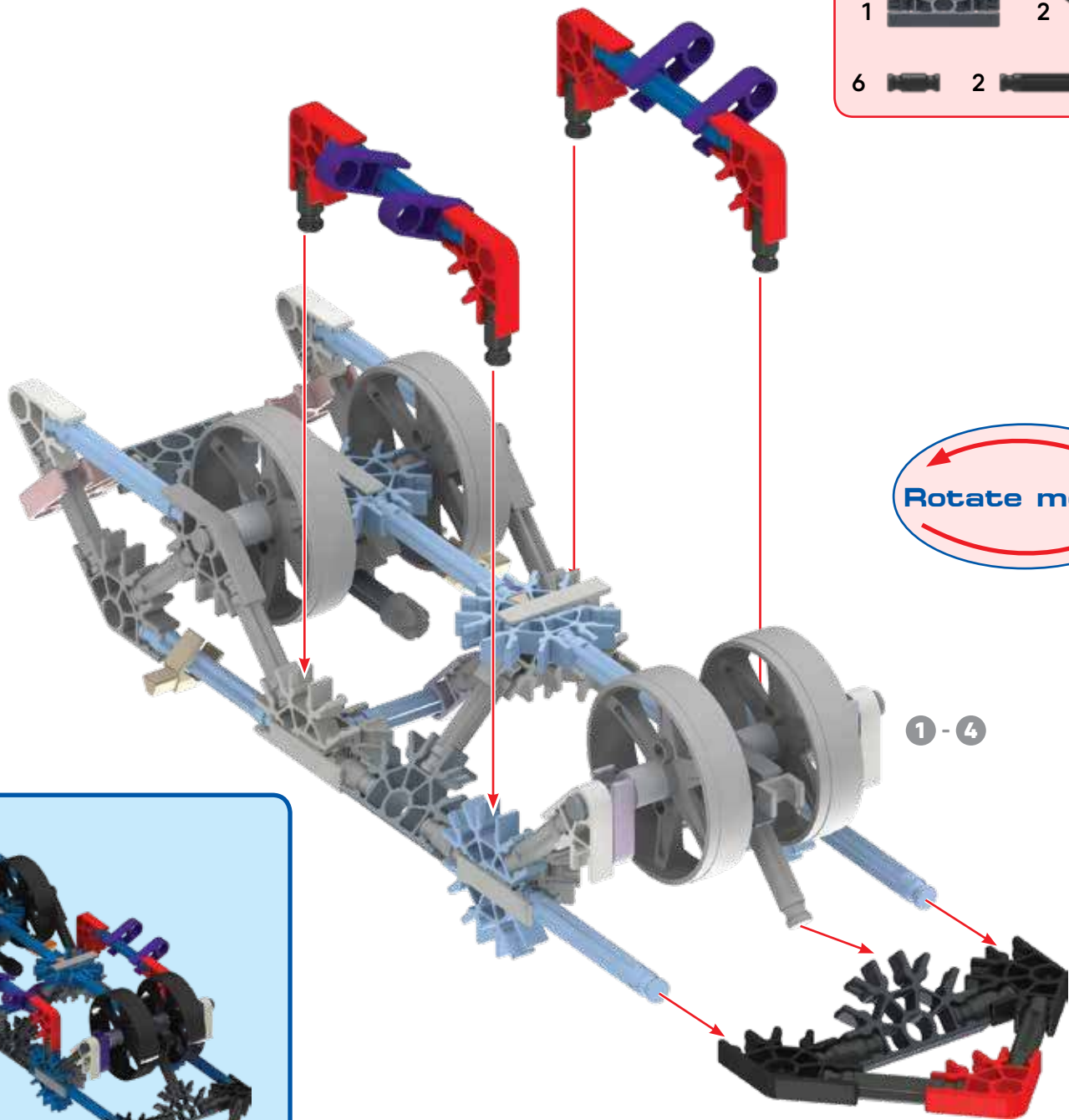

6

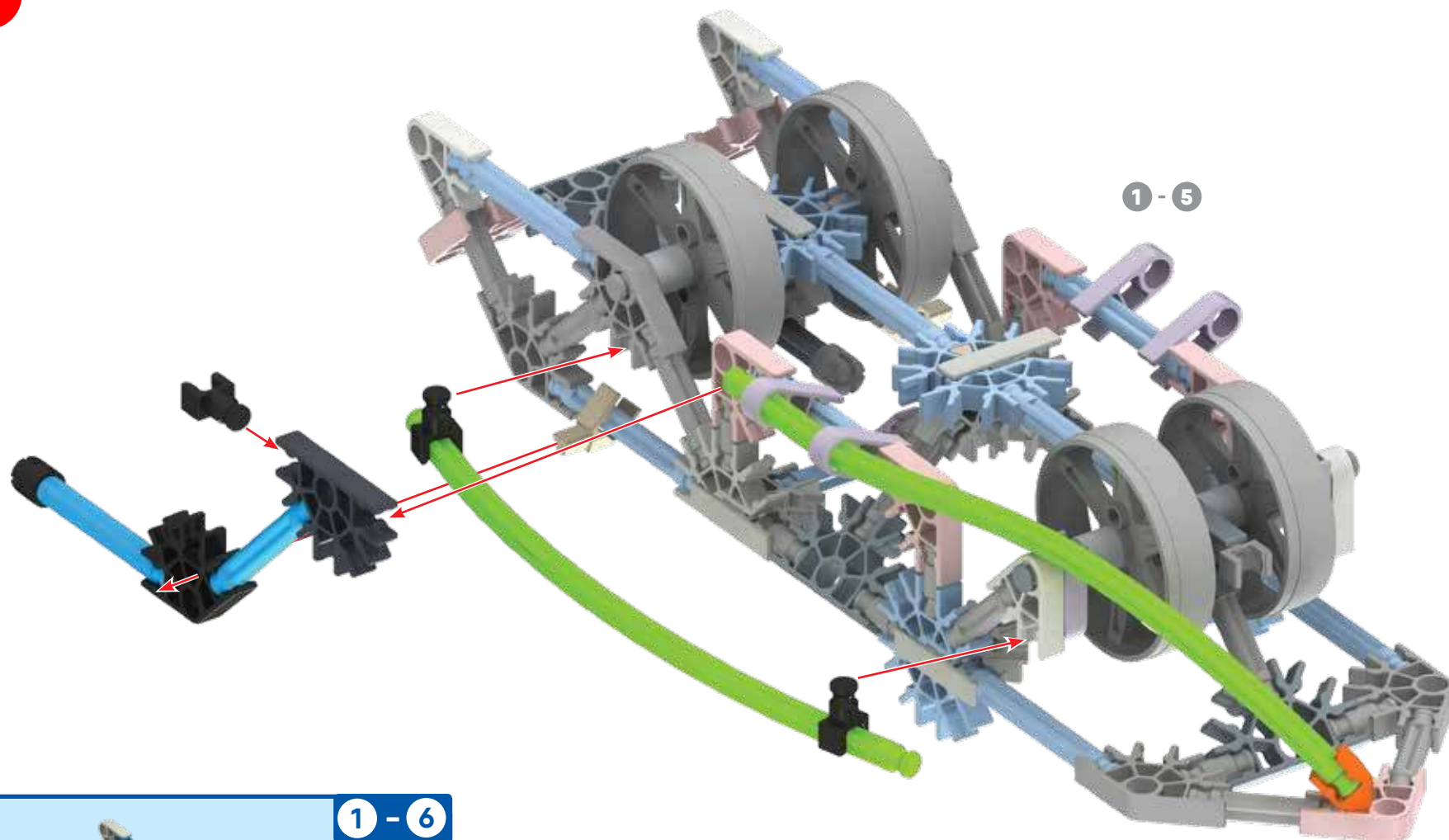

- 2
- 2 1 3 1
- 1 1

7

Rotate model

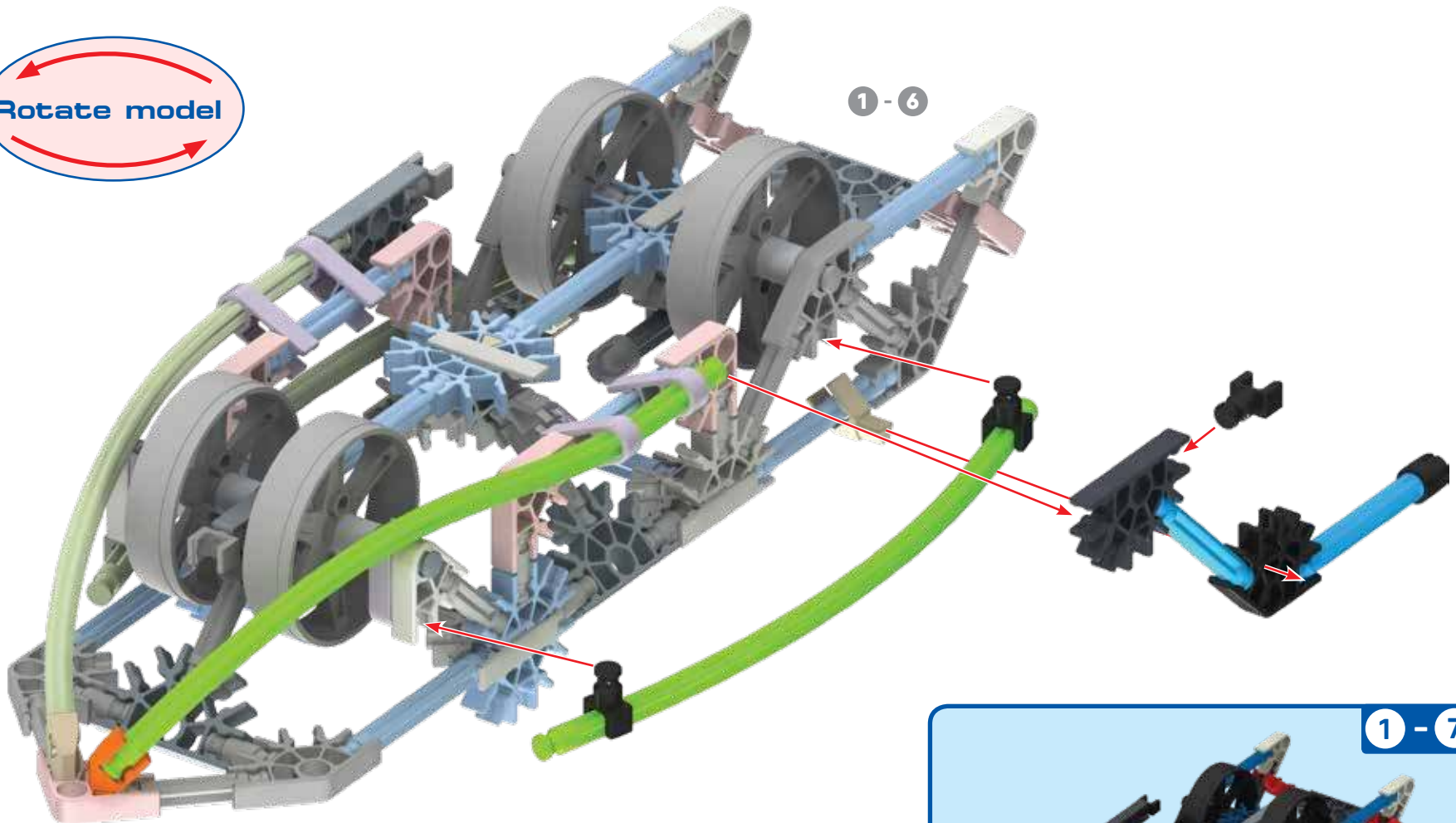

- 2
- 2 1 3 1
- 1
- 1

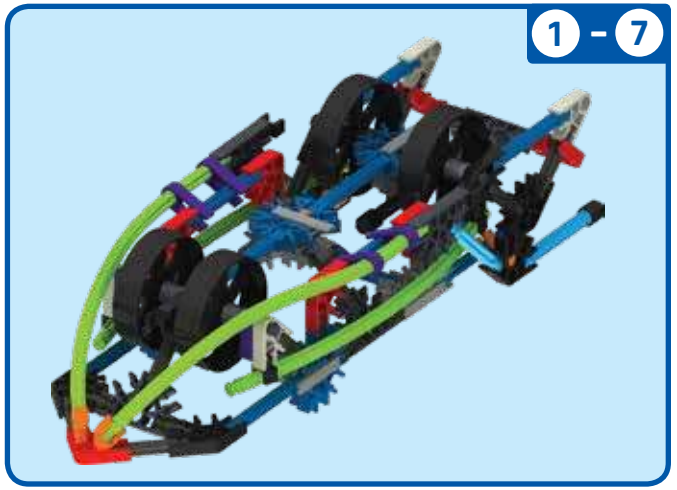

8

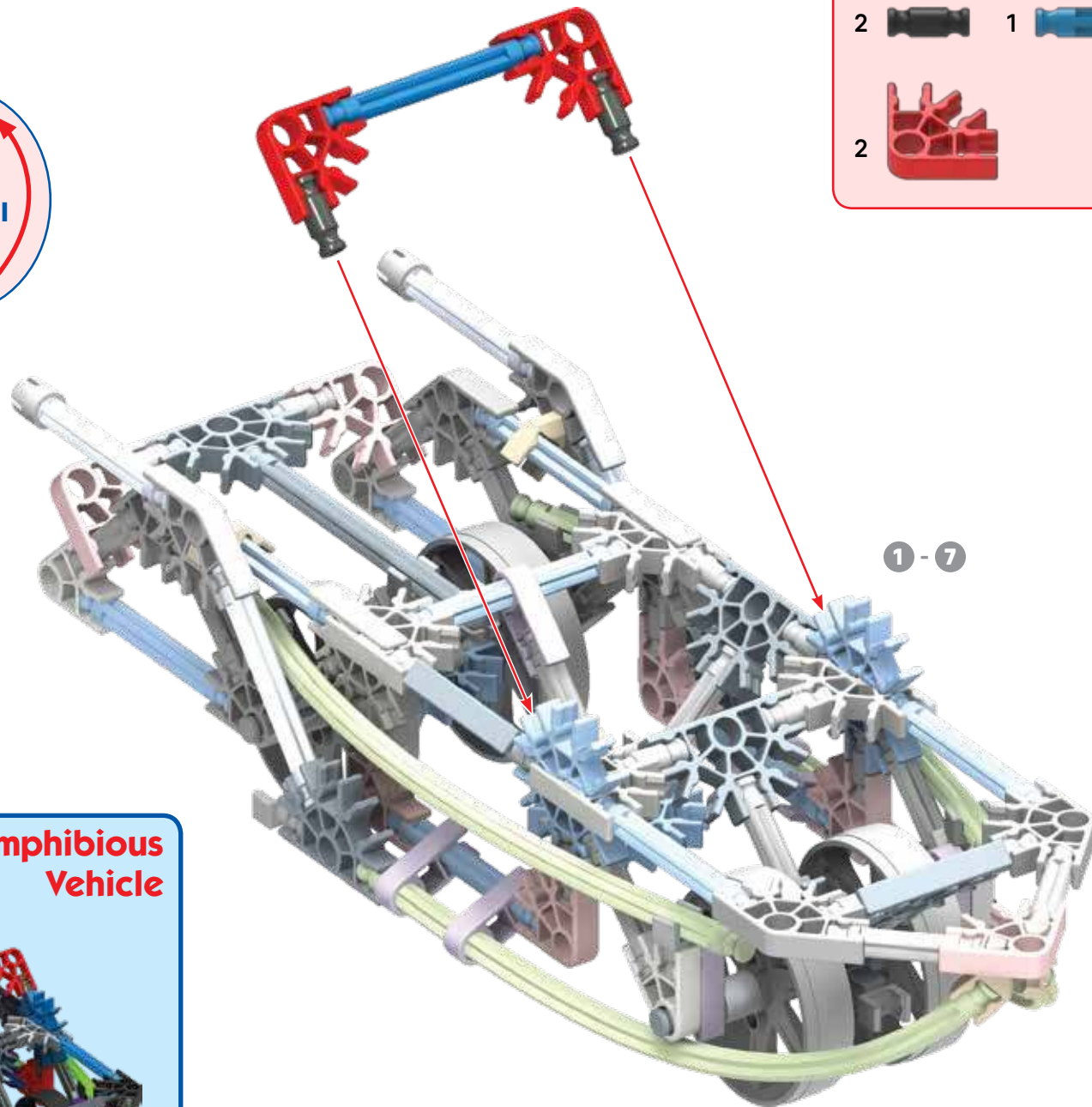
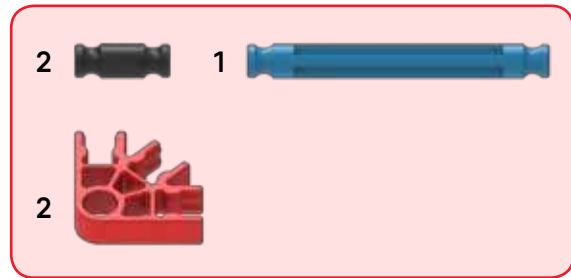
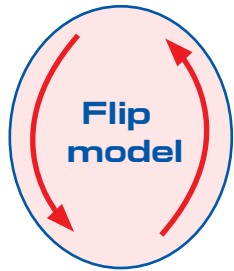

1 - 8

Amphibious
Vehicle



1

X2

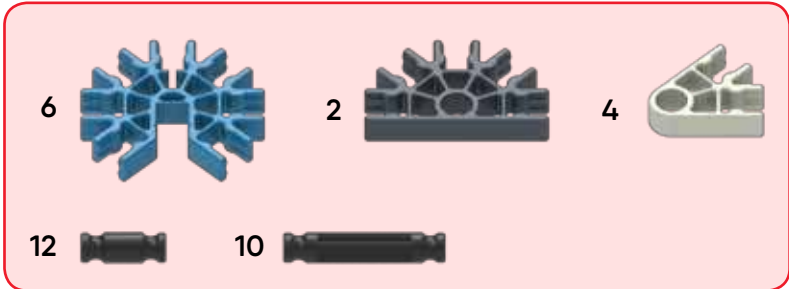
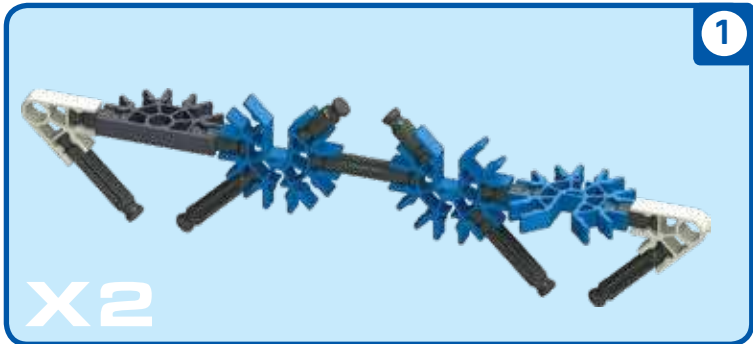
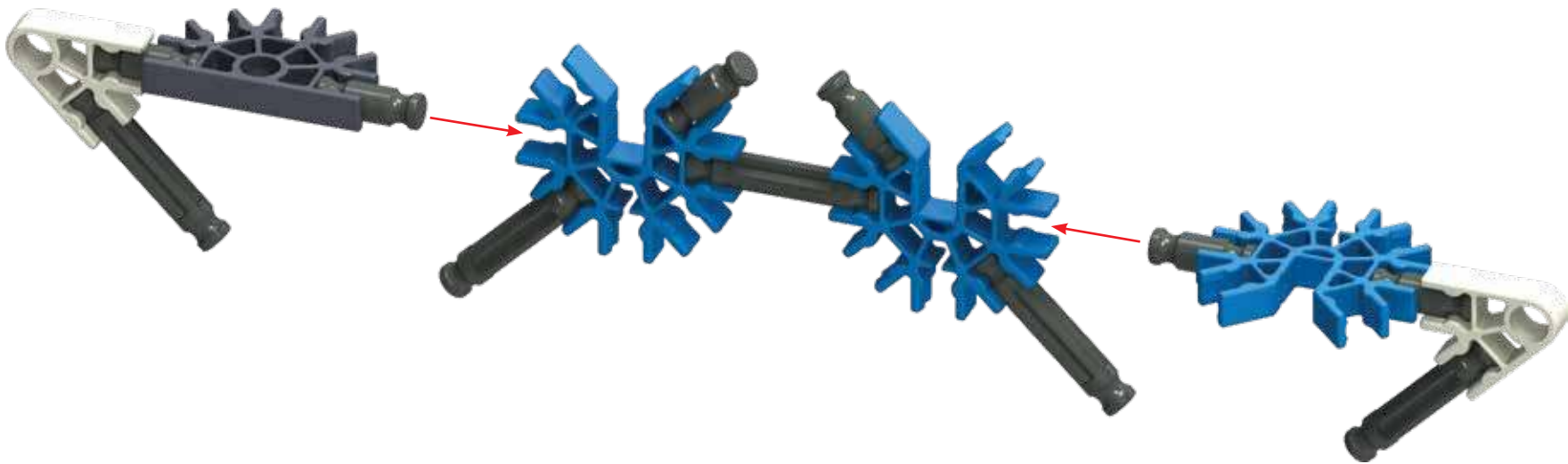

2

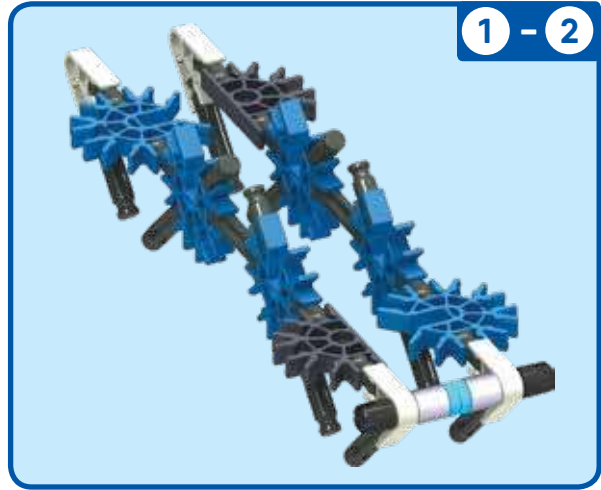
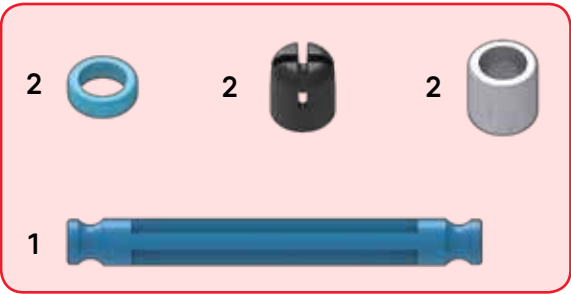
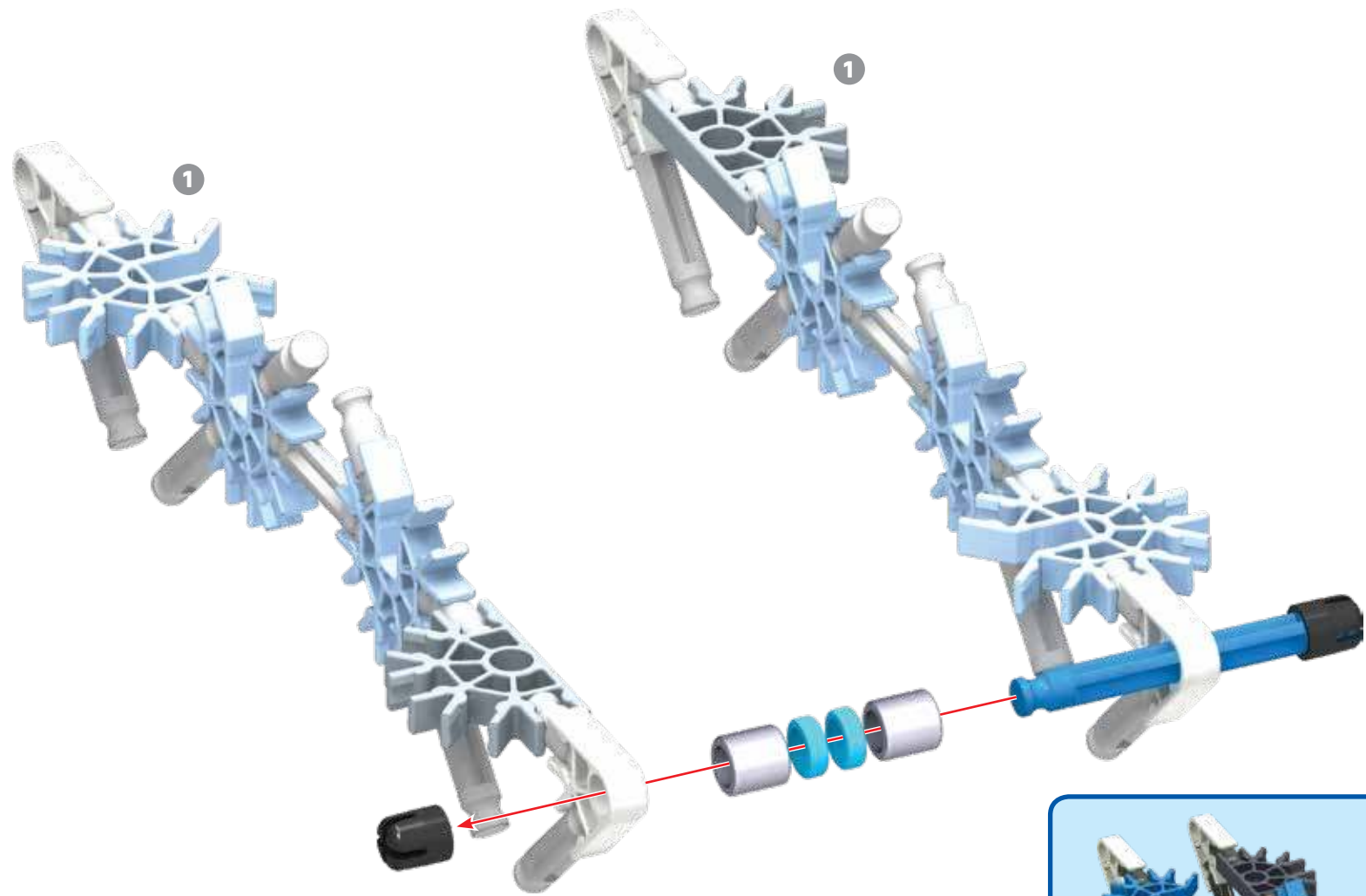

3

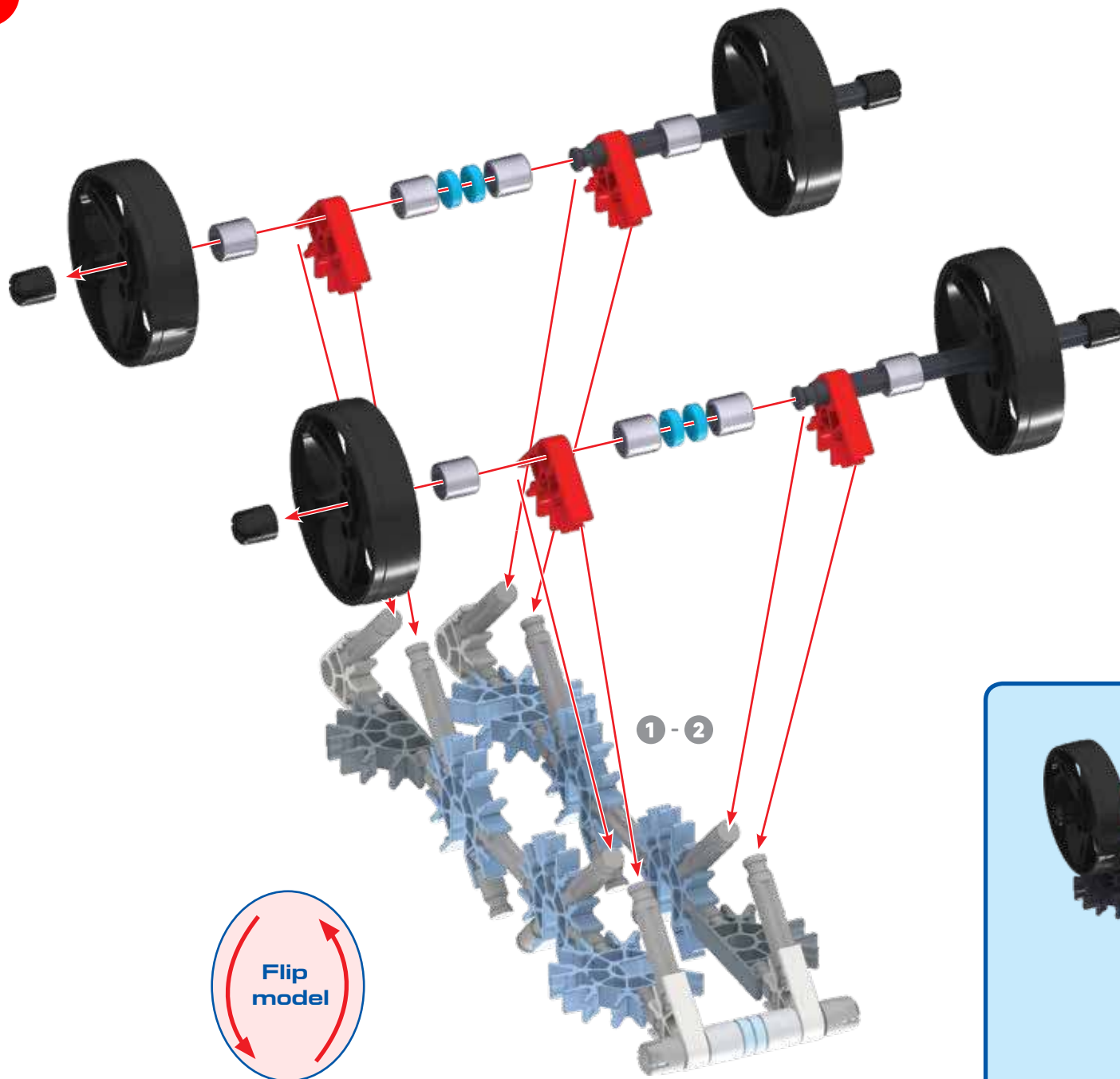

- 4  8  4  4 

- 2 



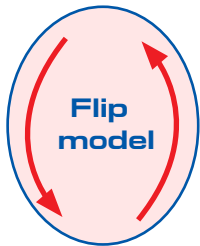



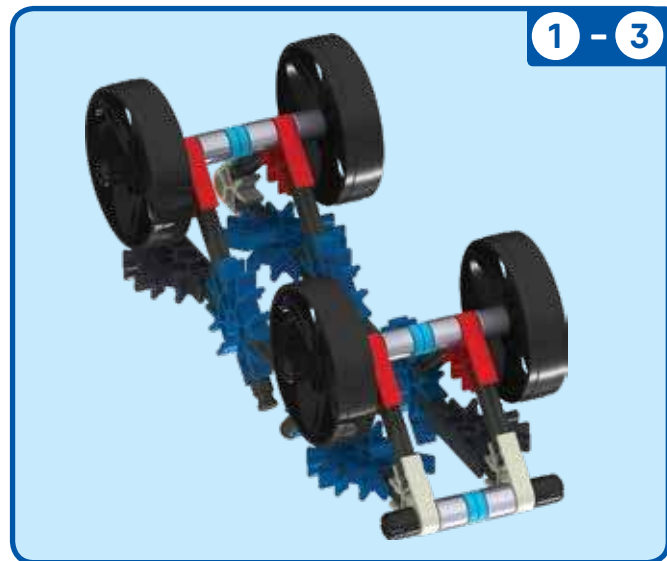

- 4 

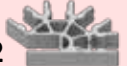

1 - 2





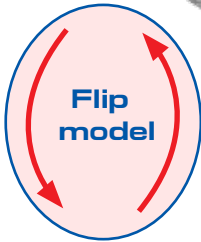
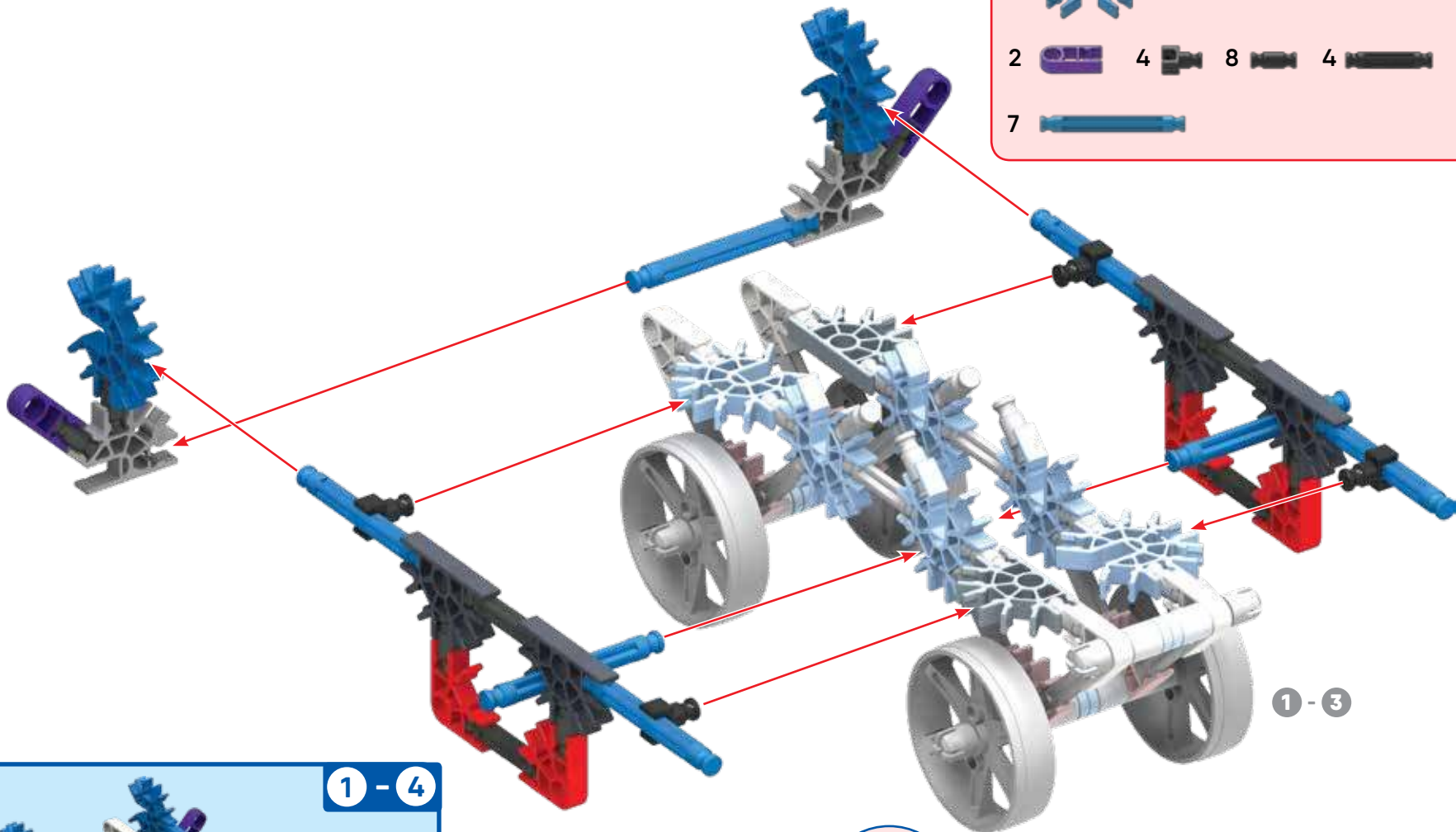

4

- 2 
- 4 
- 2 
- 4 
- 2 
- 4 
- 8 
- 4 
- 7 



5

- 2 
- 2 
- 2 
- 6 
- 4 
- 2 
- 2 
- 2 
- 2 
- 2 
- 2 

1 - 4

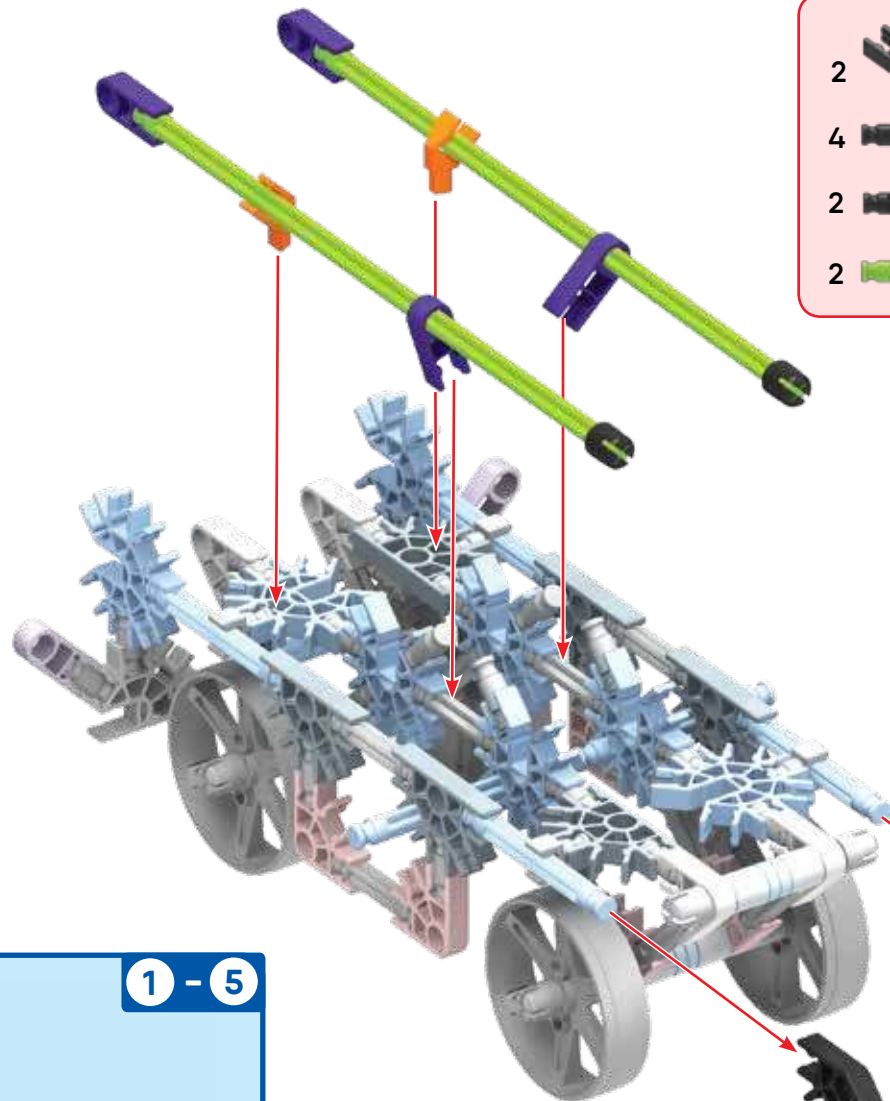

1 - 5

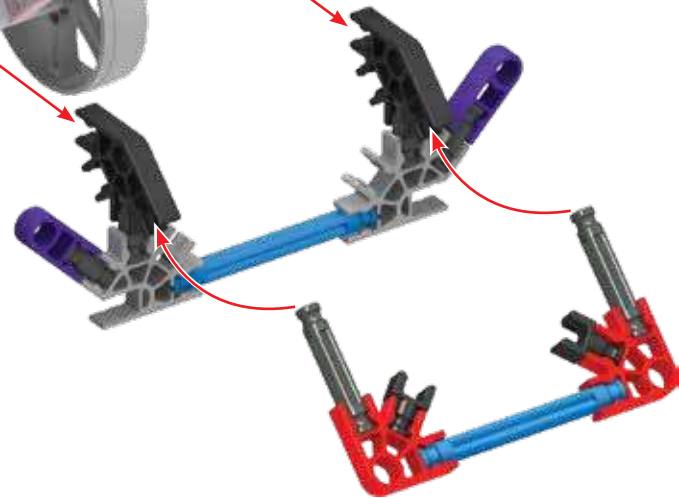

6

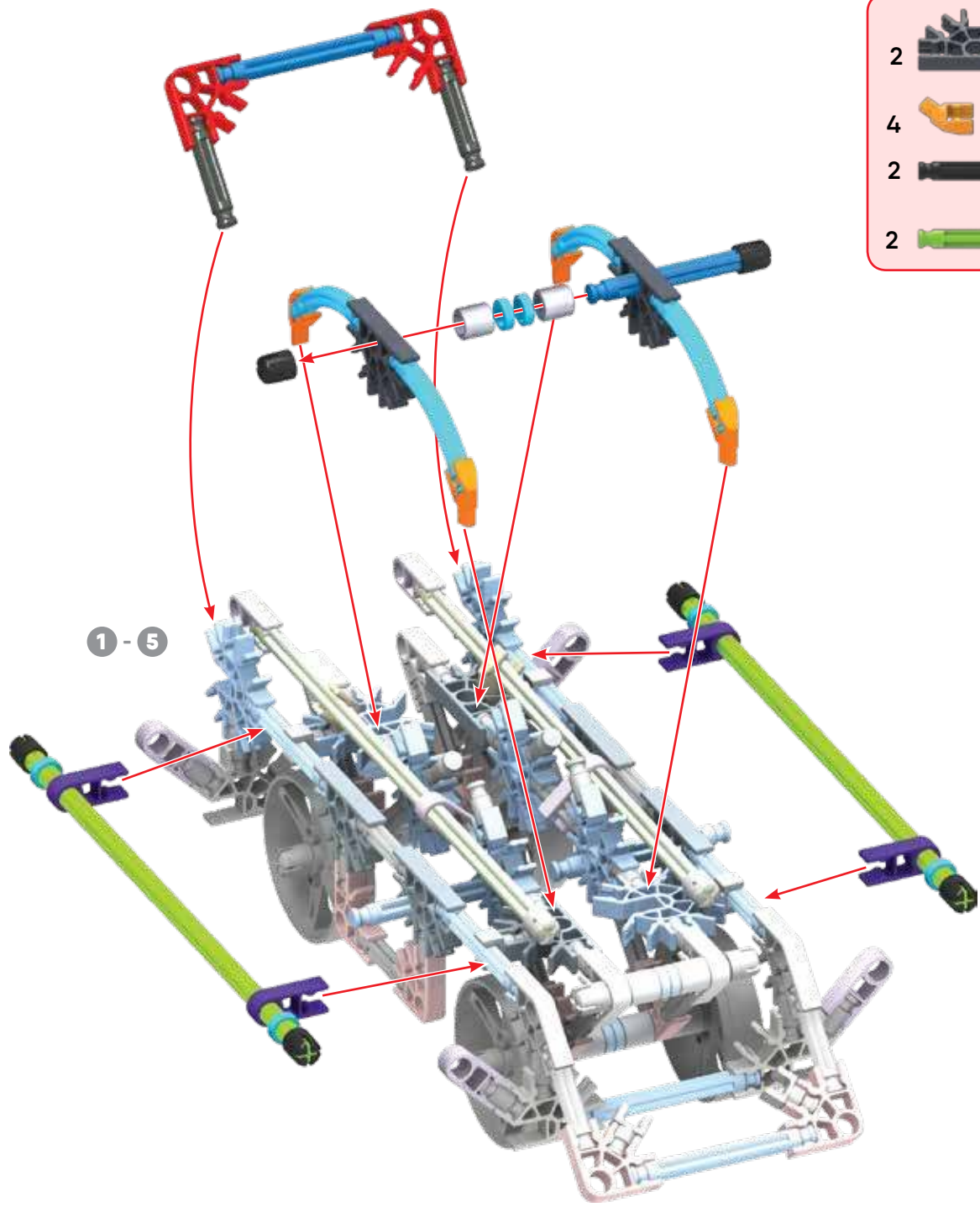

- 2
- 2
- 4
- 4
- 6
- 2
- 6
- 2
- 2
- 4
- 2



Super Car

1

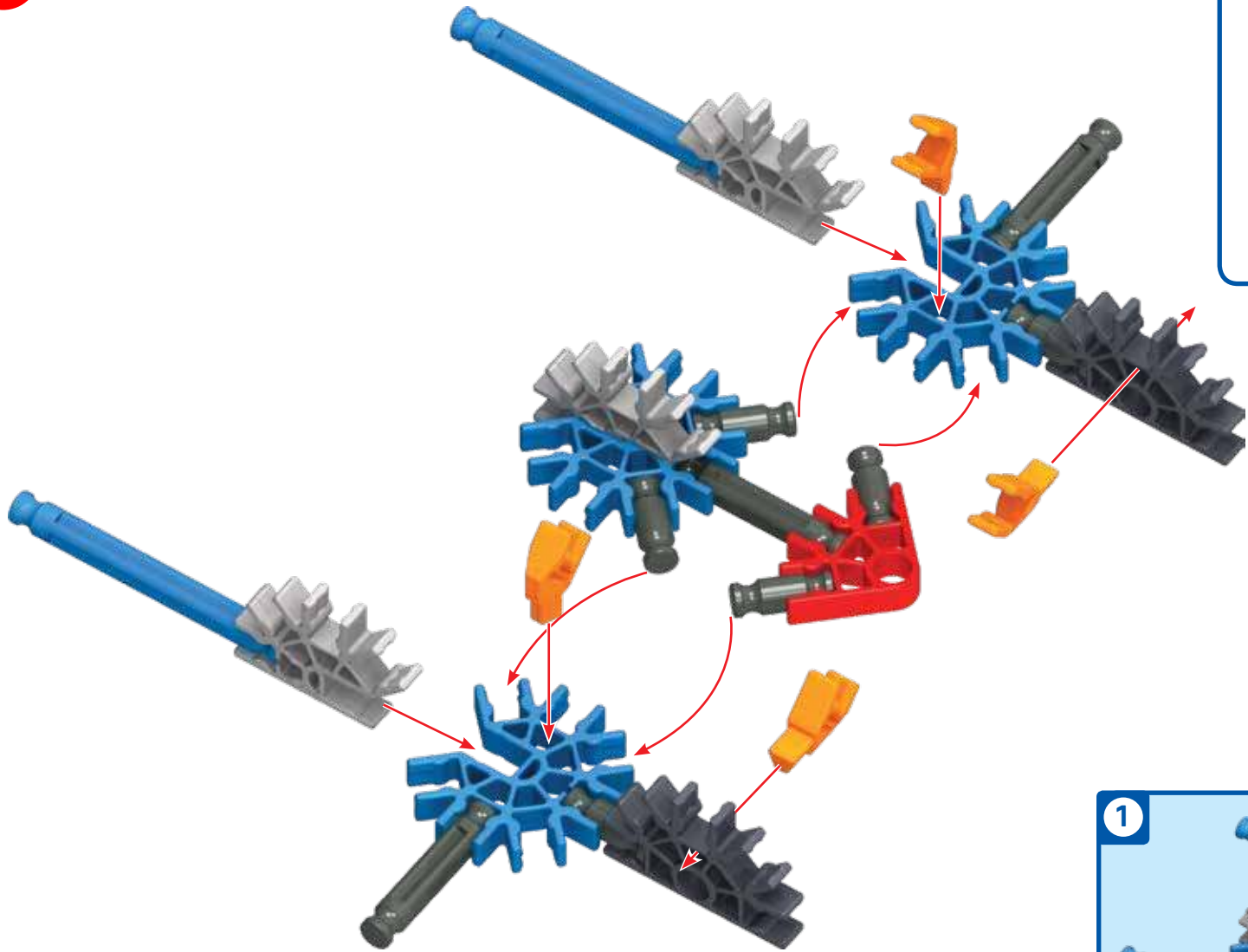

- | | | | | | | | |
|---|--|---|--|---|--|---|--|
| 3 | | 2 | | 3 | | 1 | |
| 6 | | 3 | | 2 | | 4 | |



2

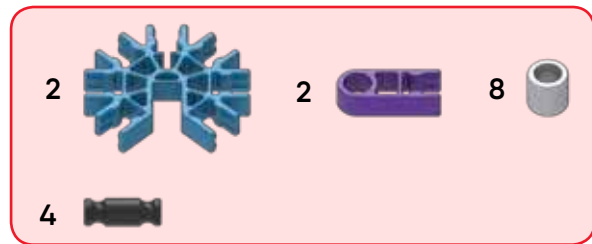
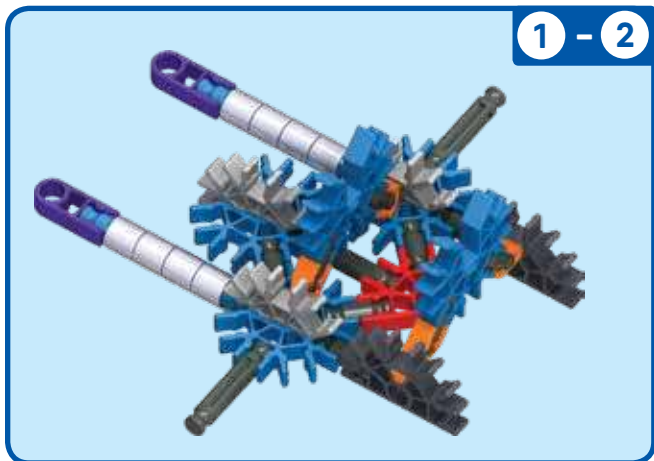
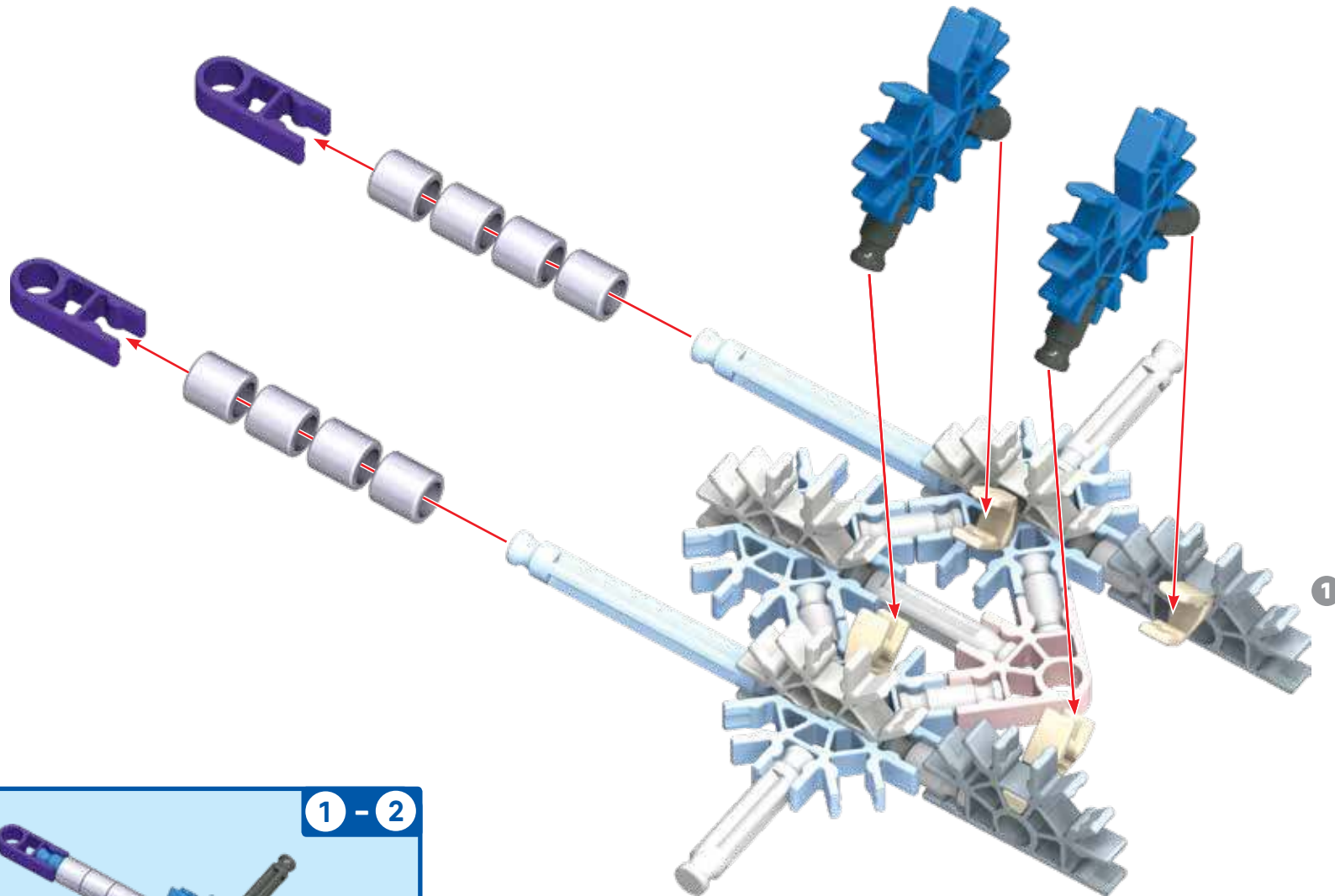





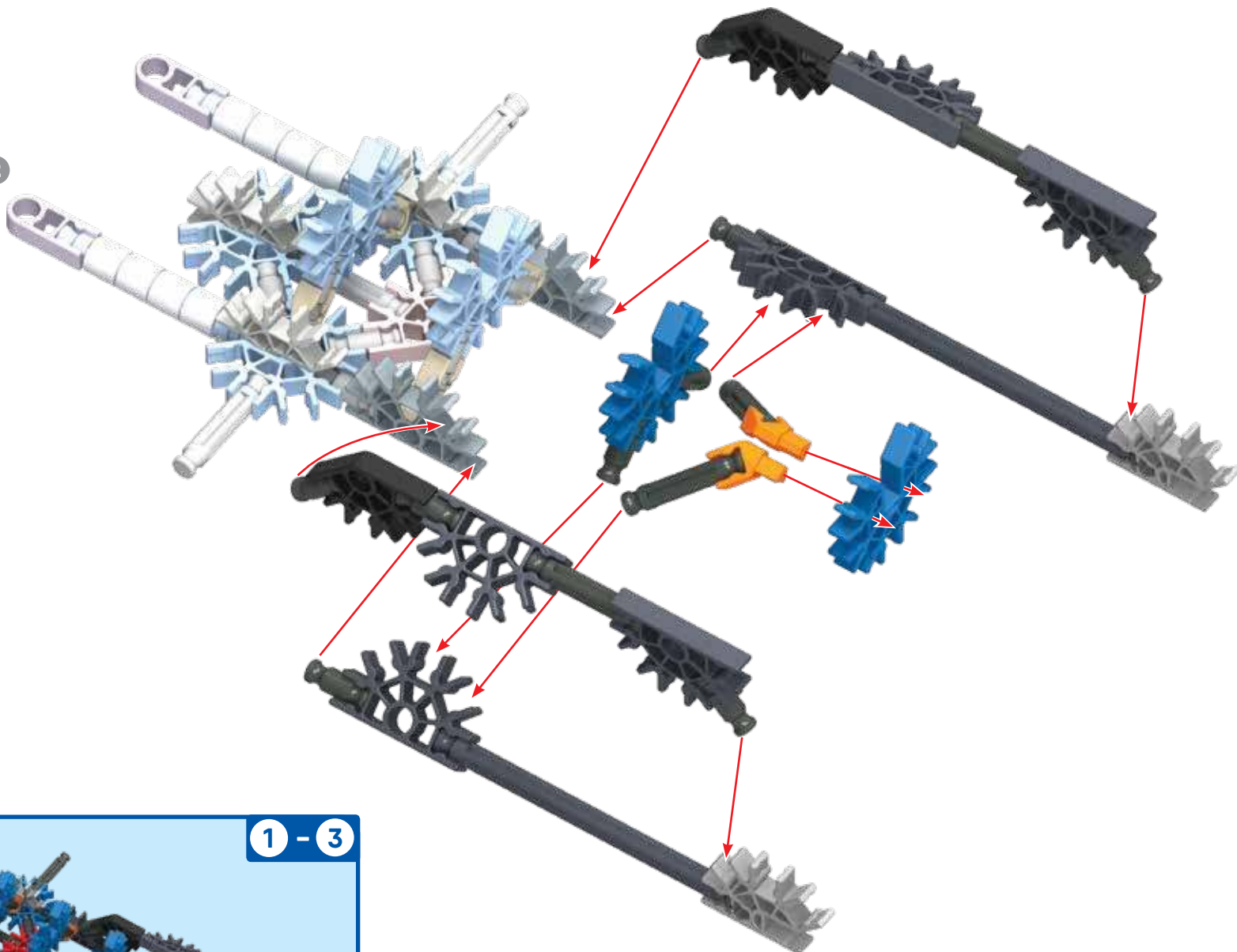



3

1 - 2



1 - 3



- 2 
- 6 
- 2 
- 2 
- 2 
- 10 
- 4 
- 2 

4

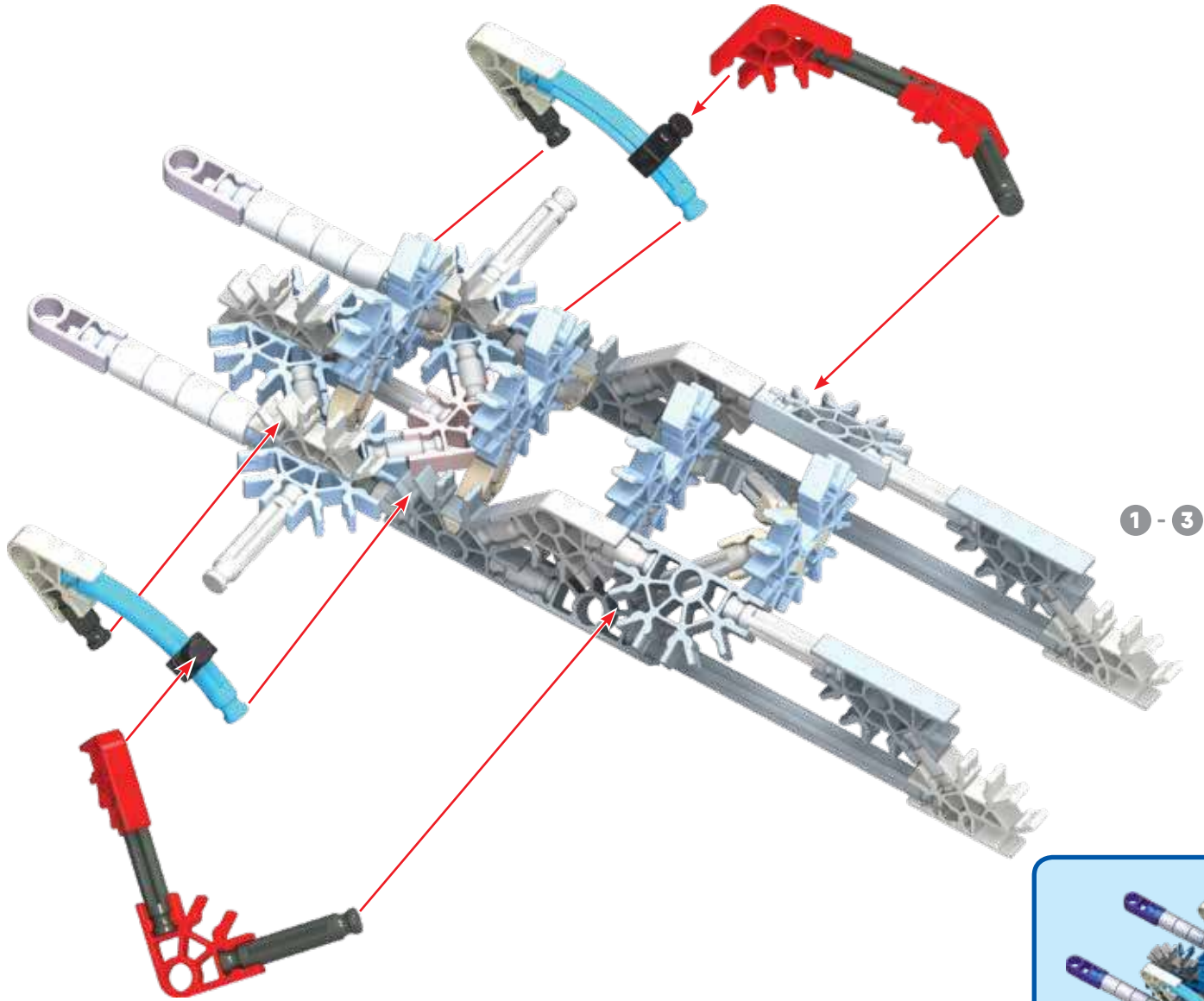







1 - 3

- | | | | | | |
|---|--|---|--|---|--|
| 4 | | 2 | | 2 | |
| 2 | | 4 | | 2 | |



1 - 4

5

- 1 
- 1 
- 2 
- 3 
- 1 
- 1 
- 4 

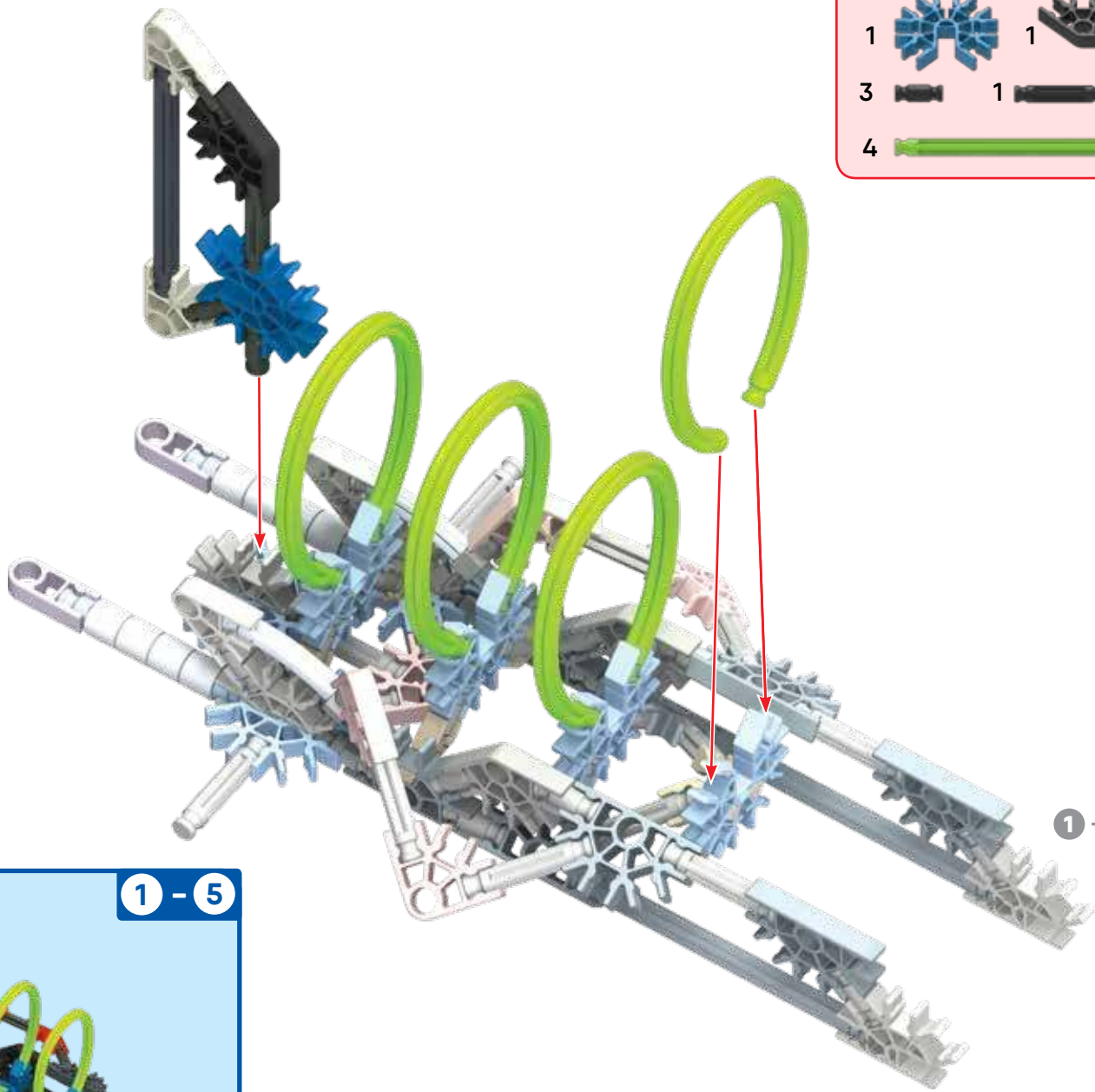

6

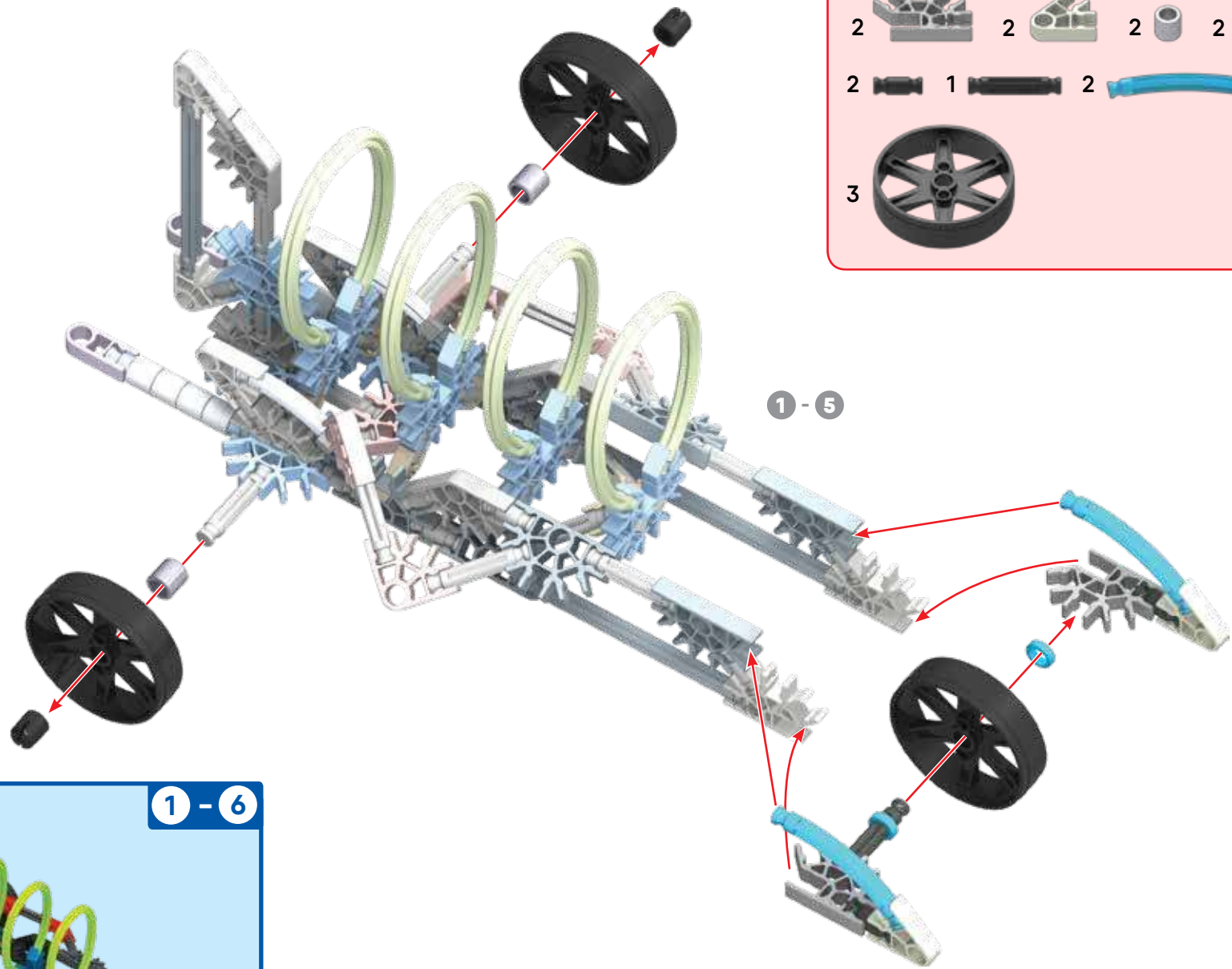

- 2
- 2
- 2
- 2
- 2
- 2
- 1
- 2
- 3

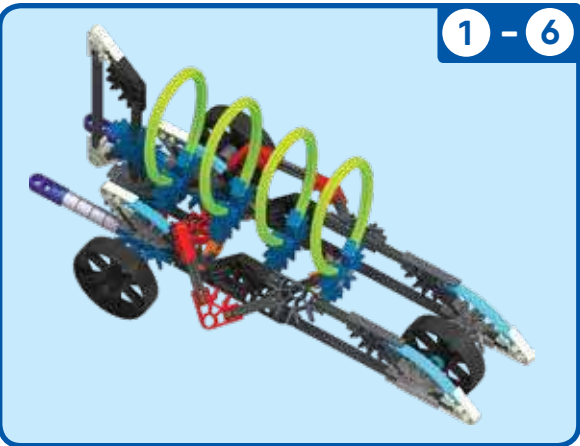

1

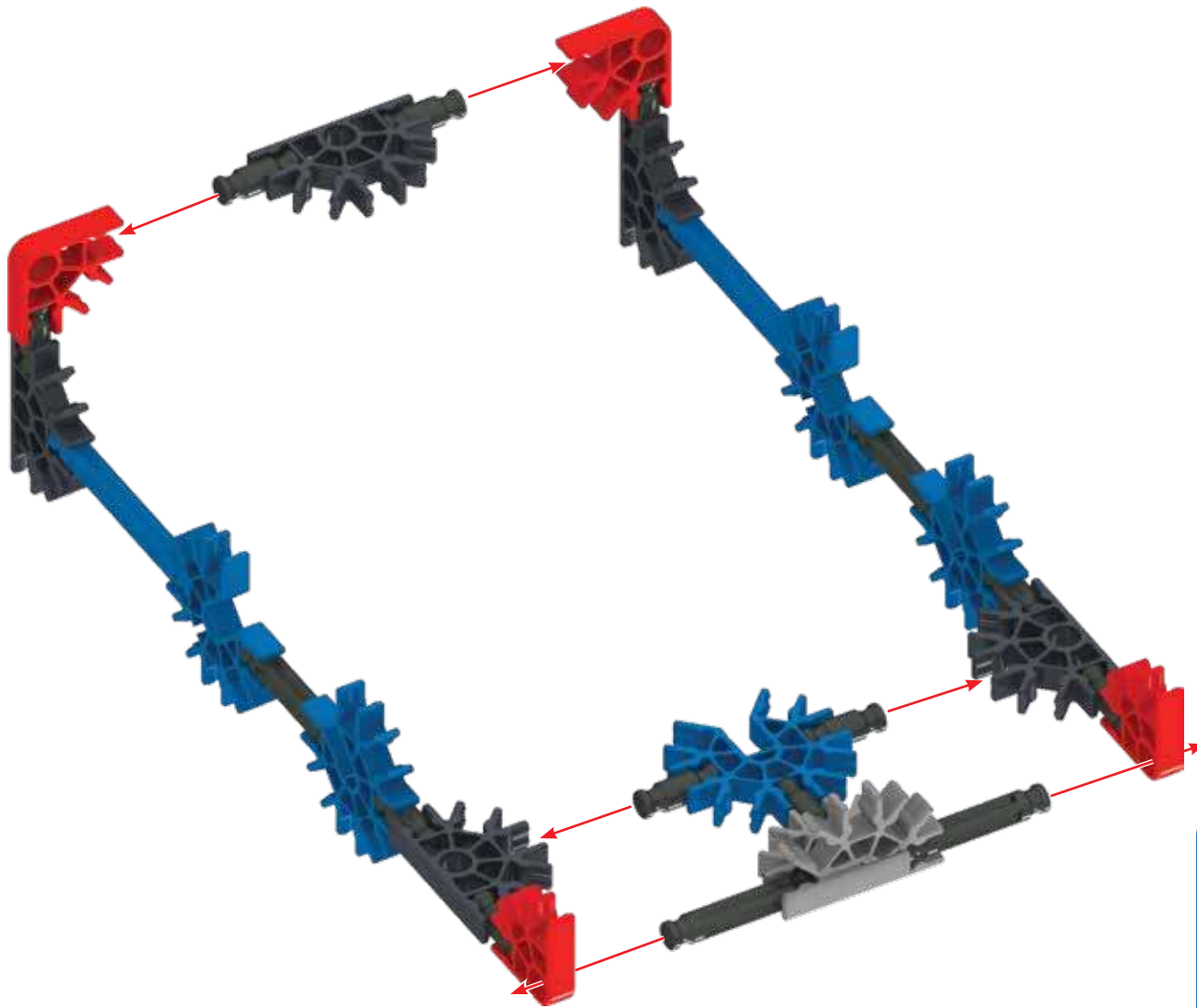

SUV

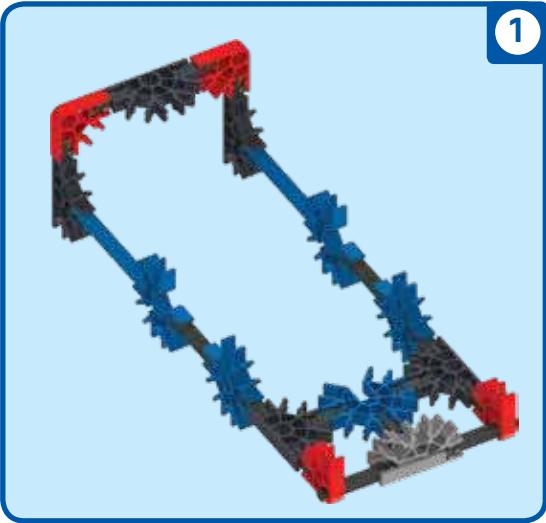
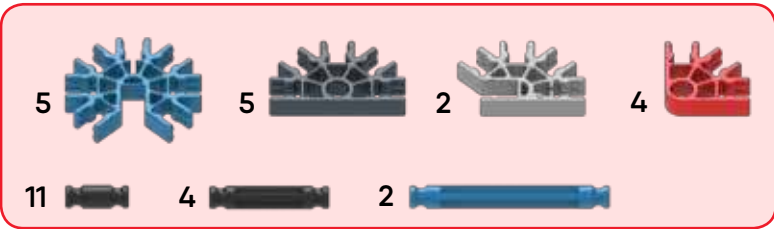

1

2

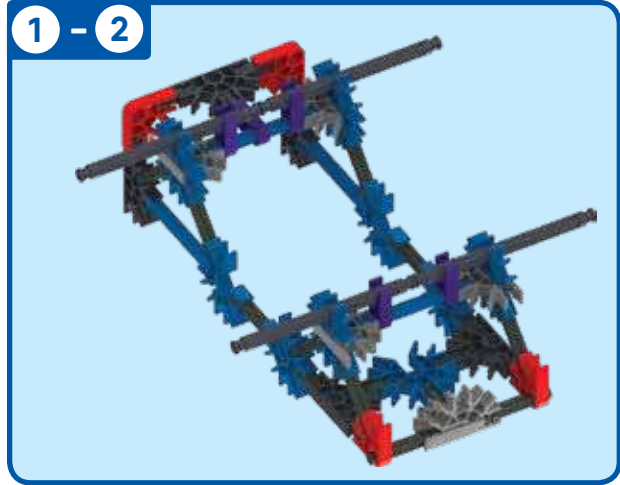
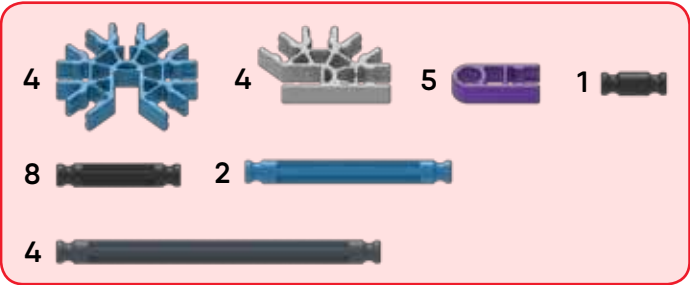
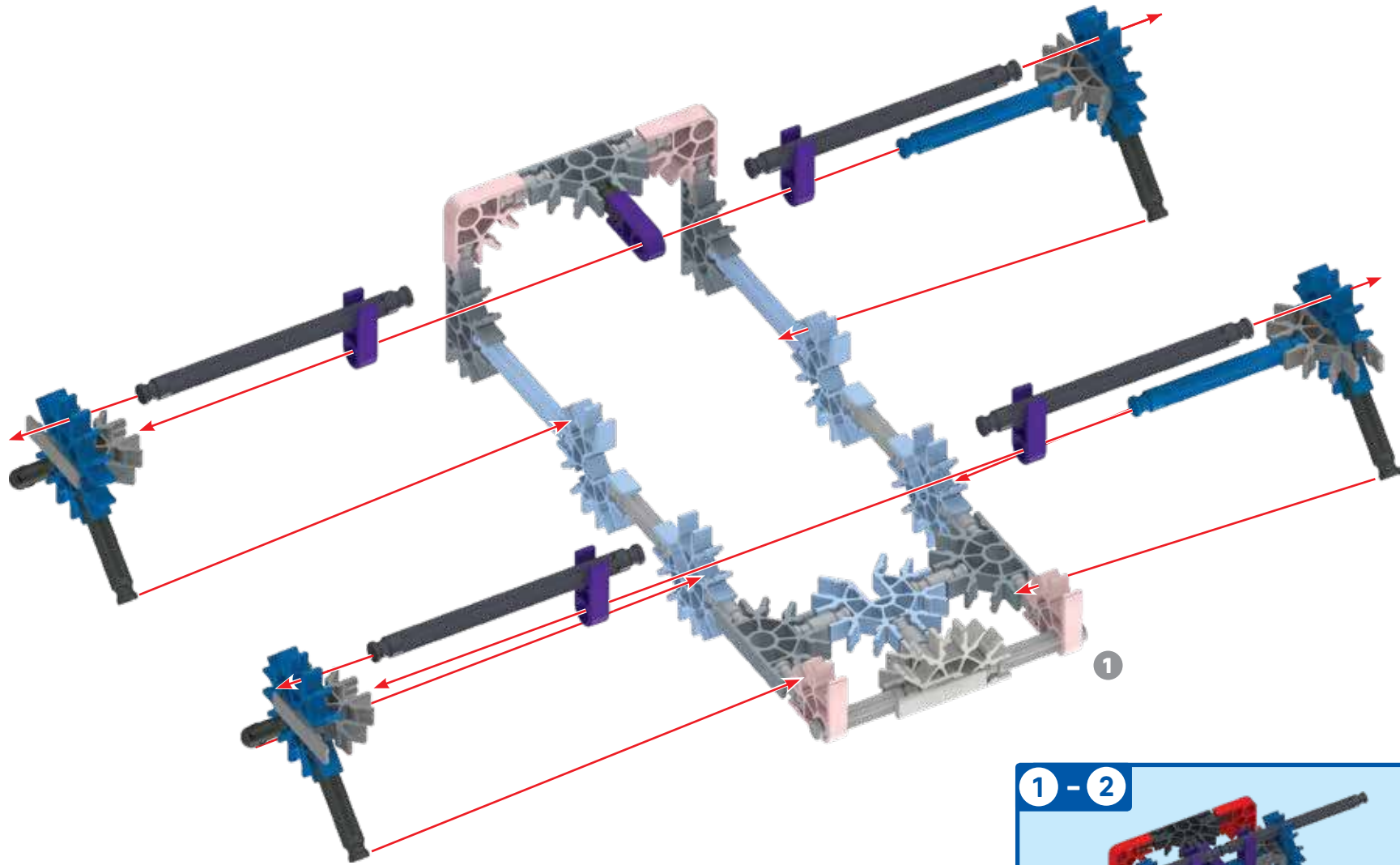



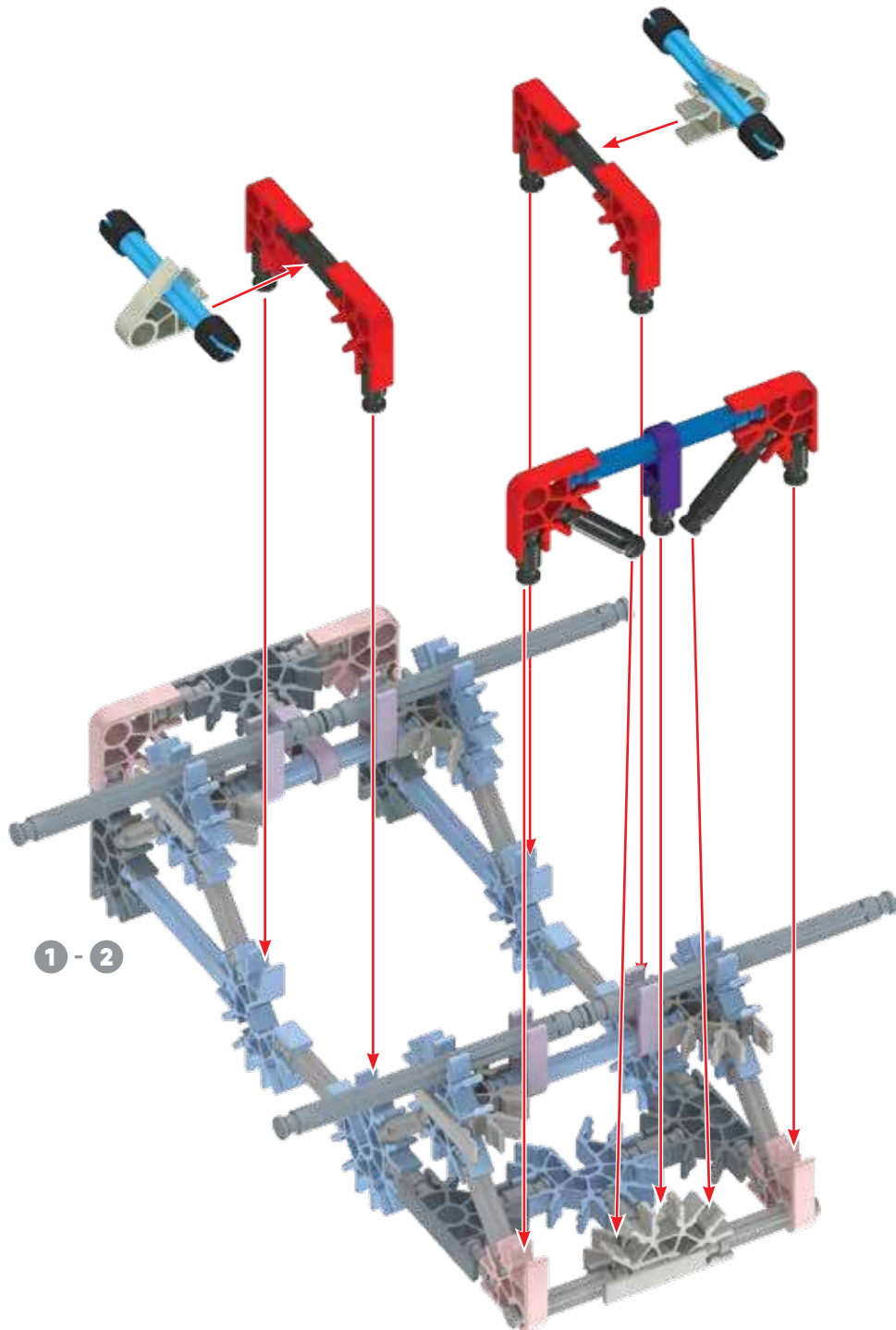



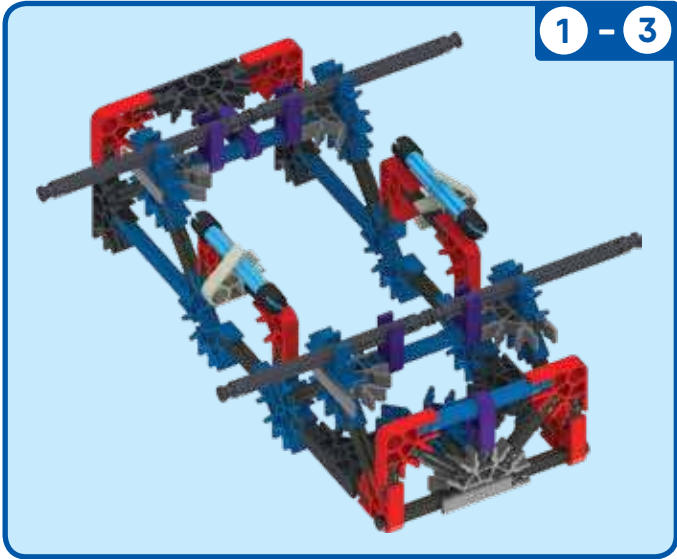

3



6		2		1		4	
7		4		2			
1							



4

- 3 
- 2 
- 2 
- 2 
- 2 
- 2 
- 8 
- 2 
- 4 

Flip model

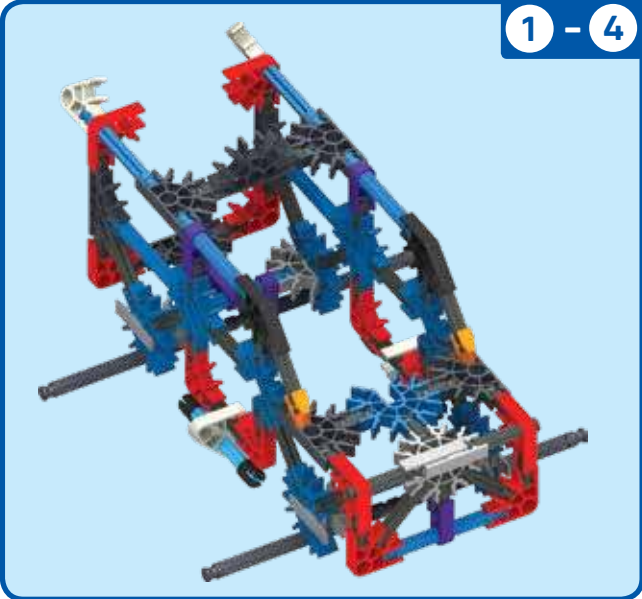
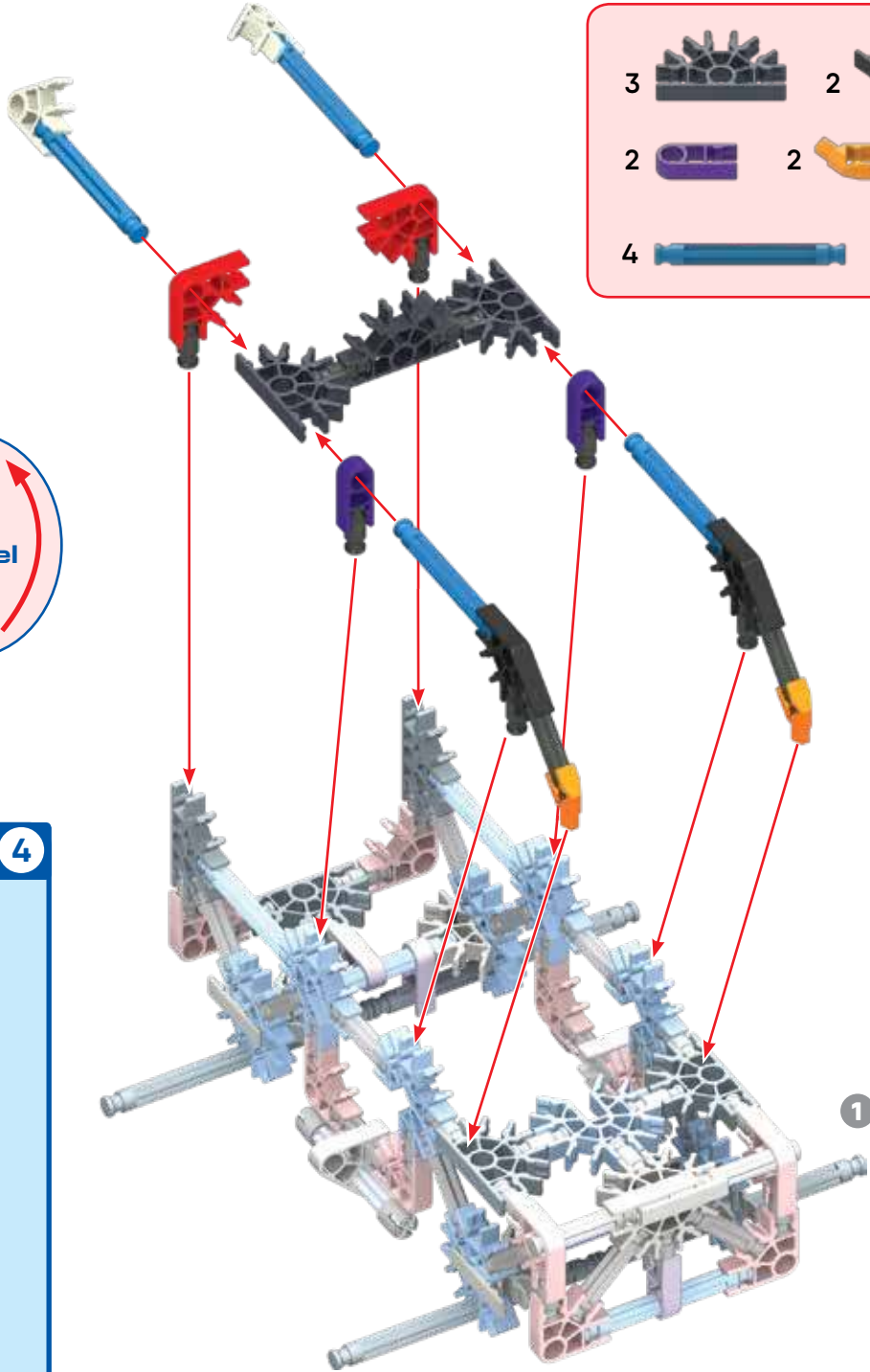

5

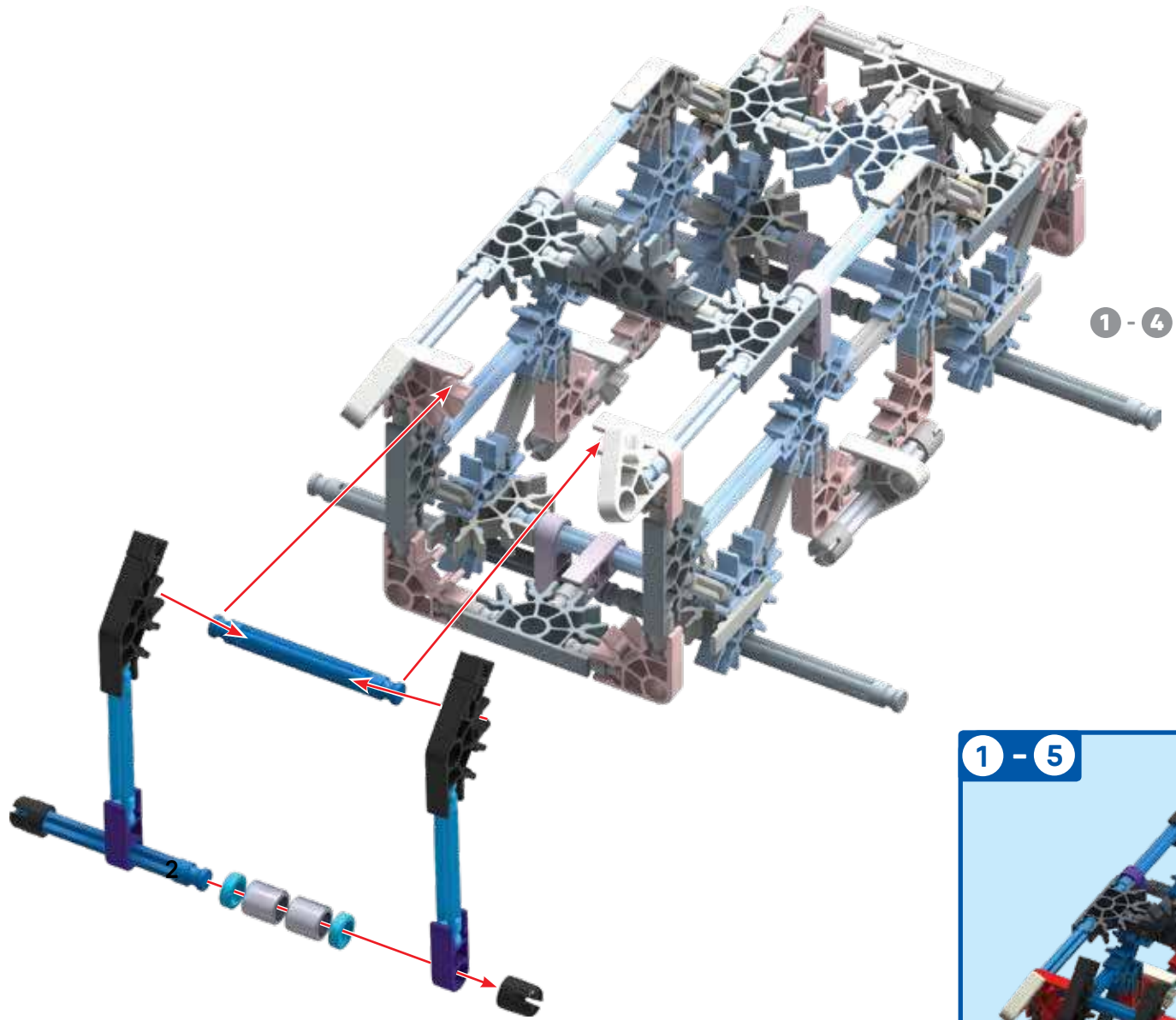

1 - 4

1 - 5

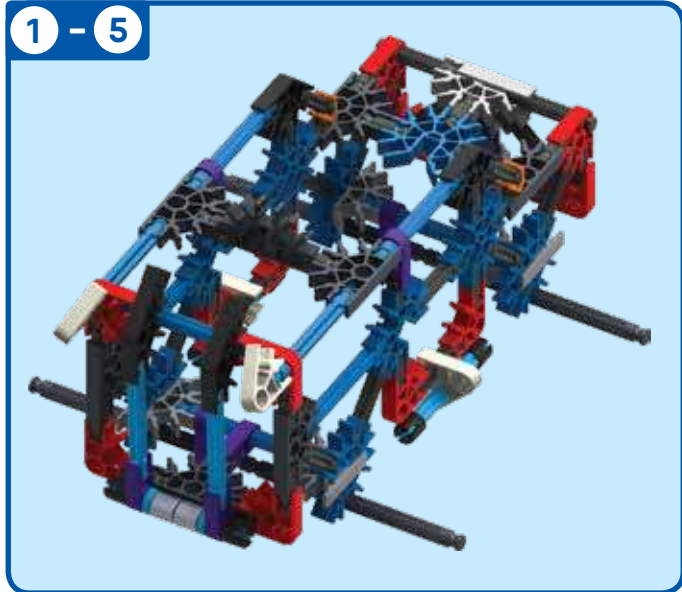

- 2
- 2
- 1
- 2
- 2
- 2
- 2
- 2

6

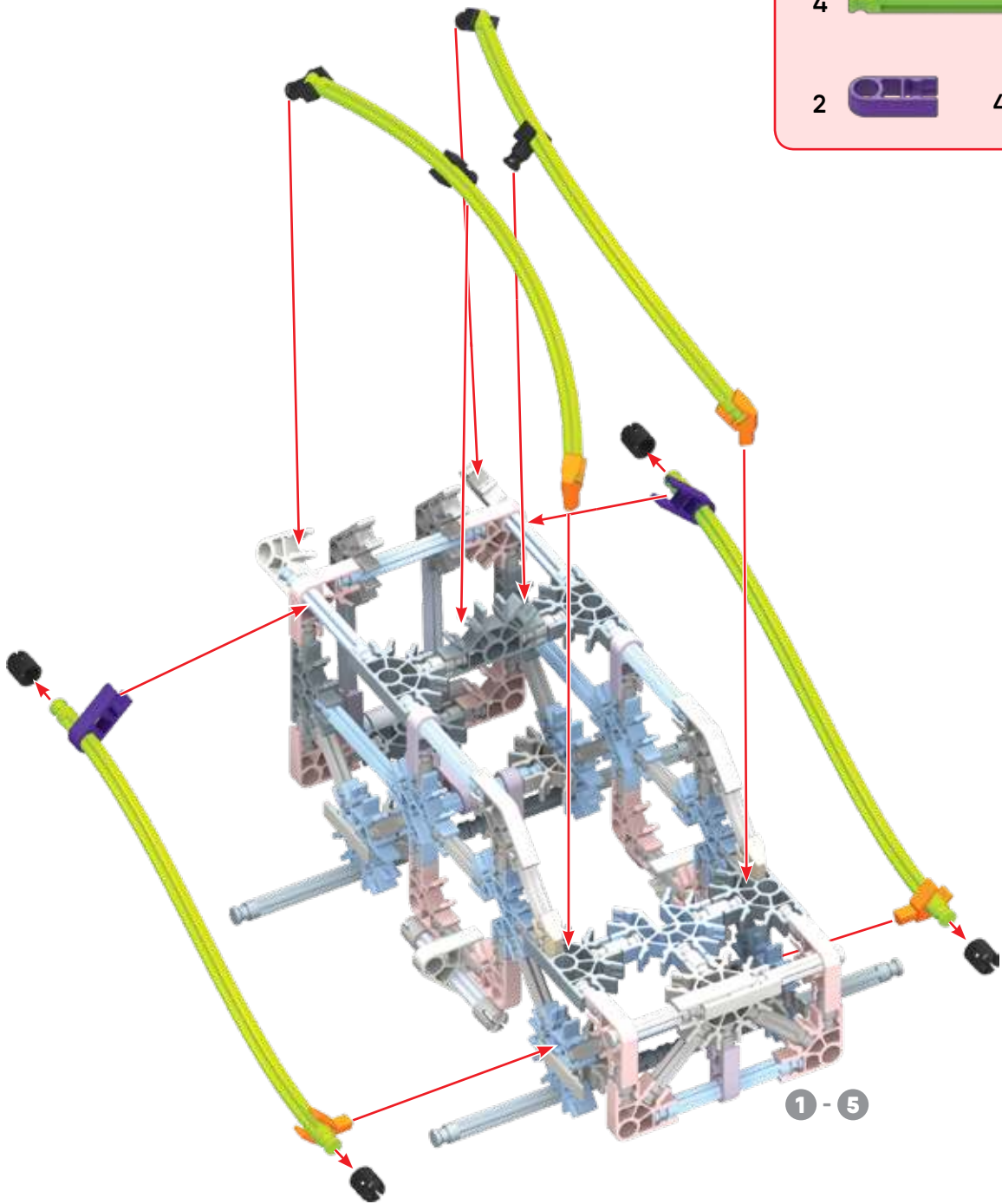

- 4
- 2
- 4
- 4
- 4

1 - 5



7

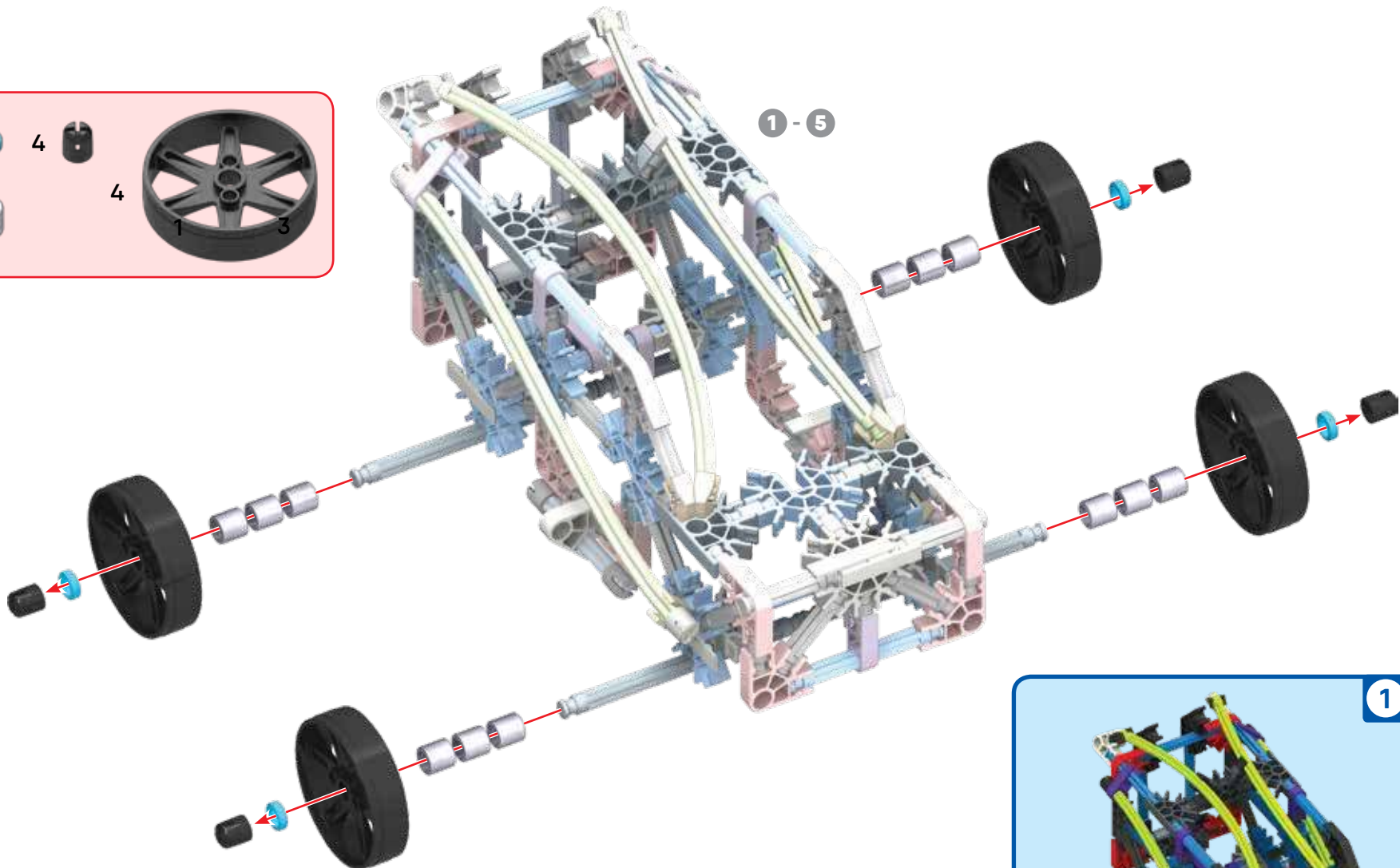
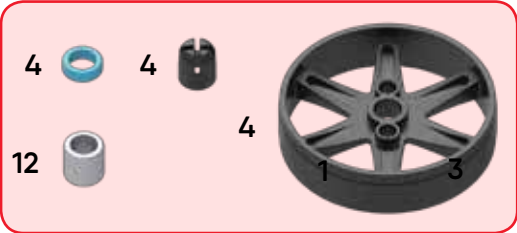

1

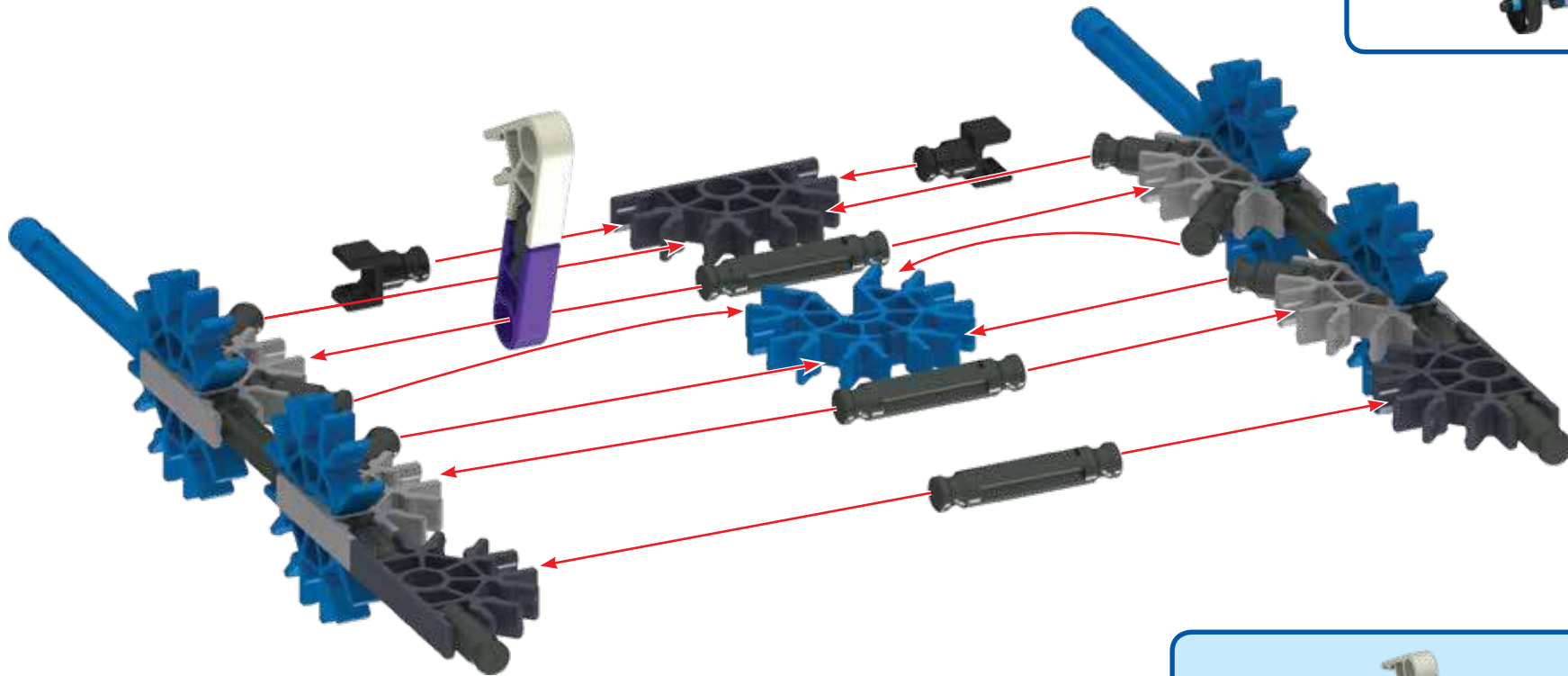



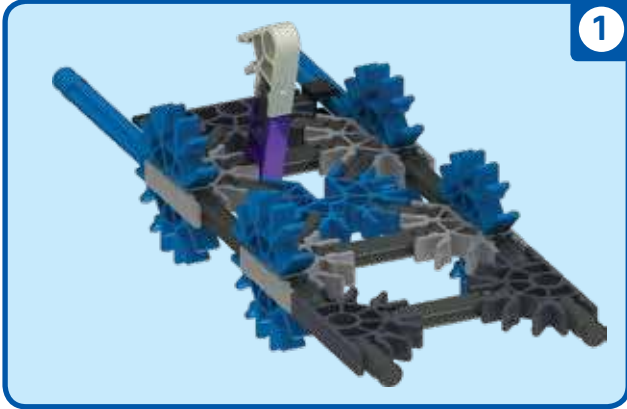

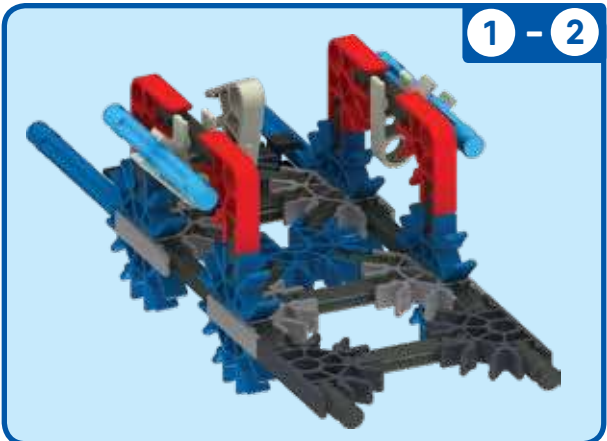
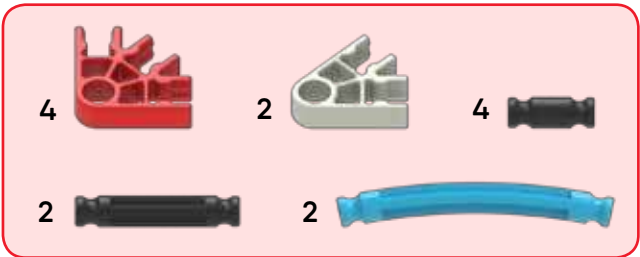
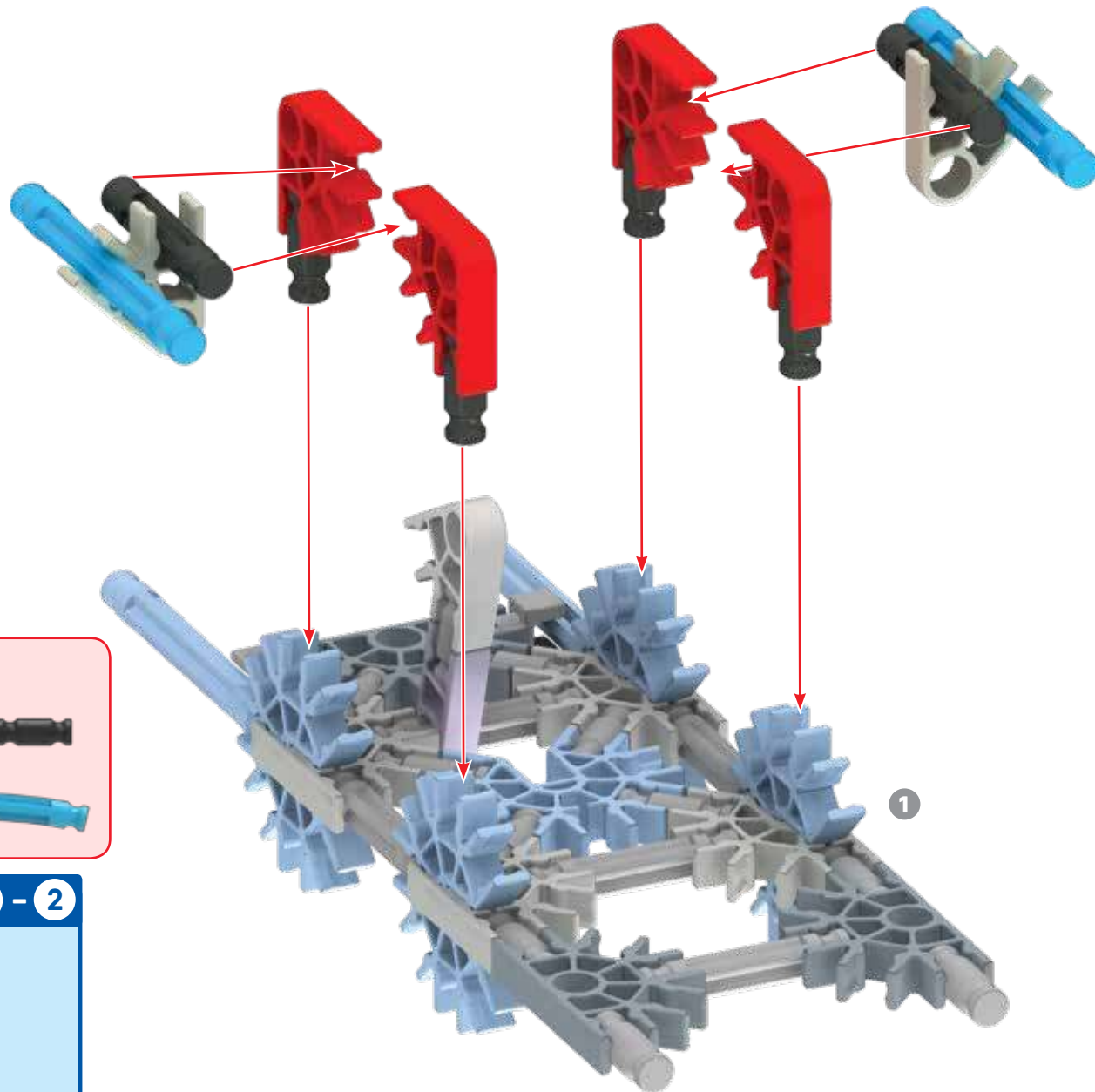

- 5
- 3
- 4
- 1
- 1
- 2
- 11
- 5
- 2



2



3

- 4 
- 4 
- 1 
- 2 
- 7 
- 4 
- 2 

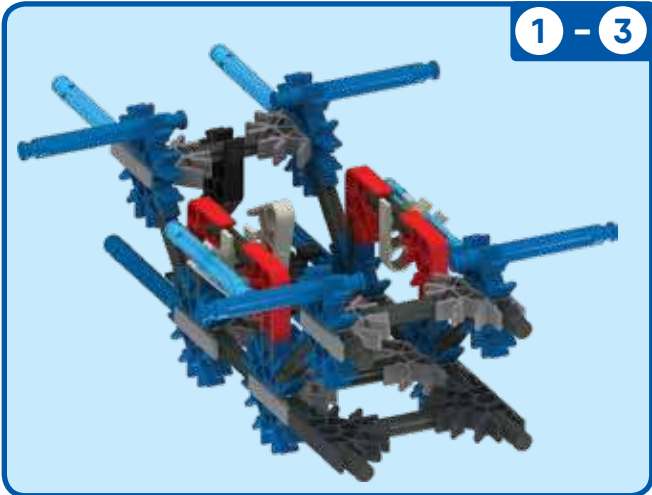
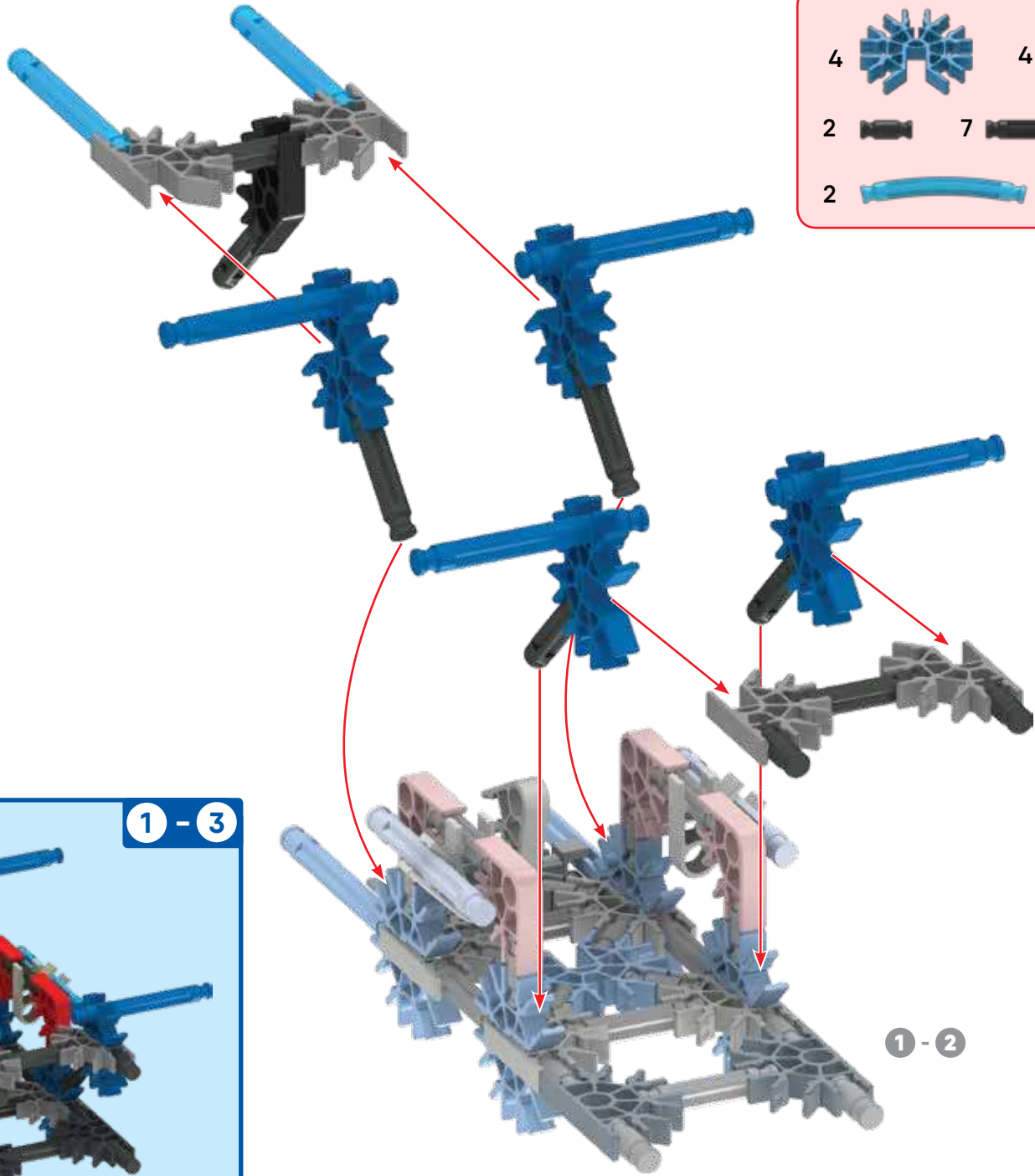

1 - 2

4

Flip model

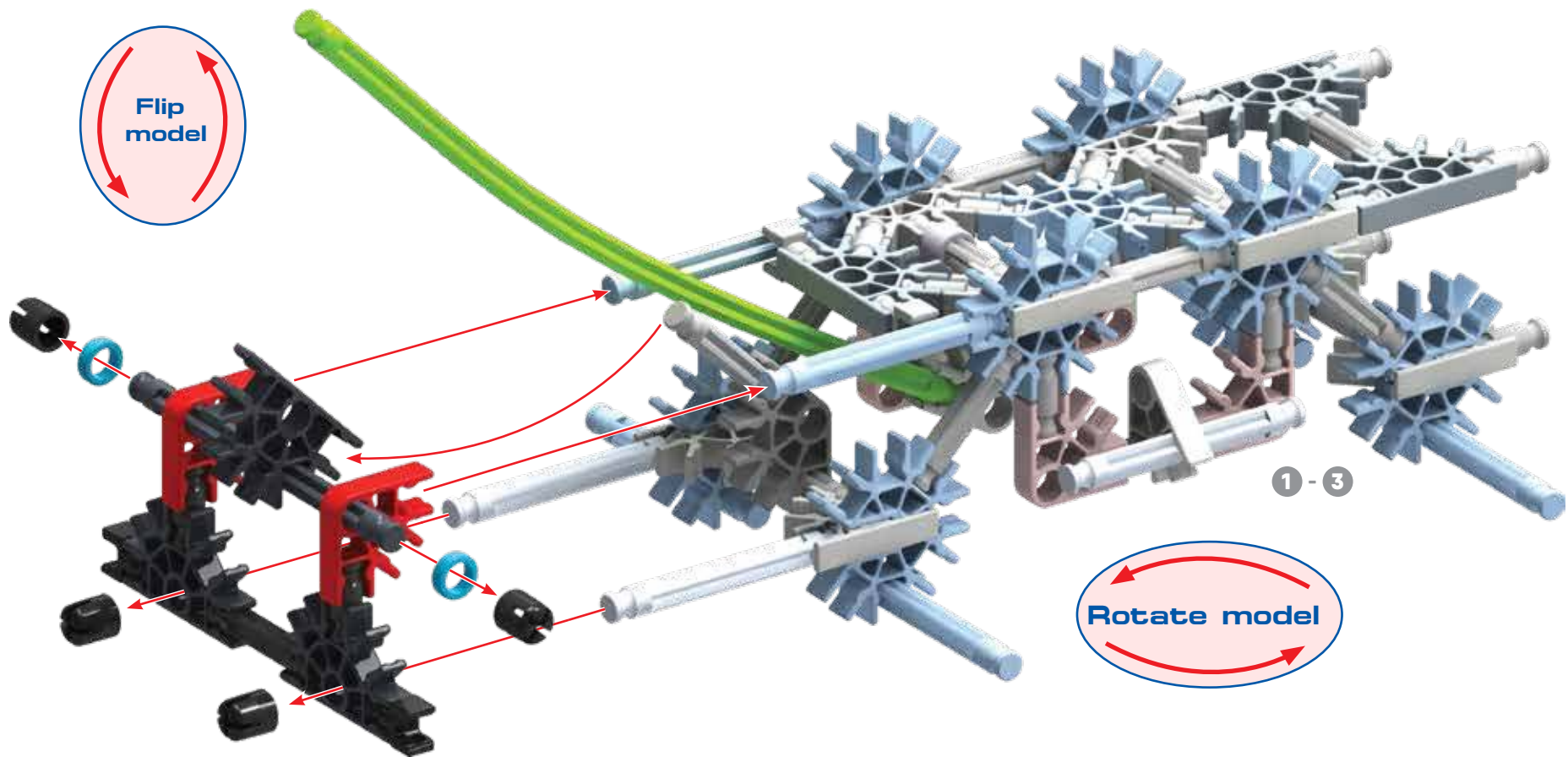









Rotate model











1 - 3

1 - 4



- 3  2  2  4  2 
- 2  1  1 
- 1 

5

- 4 
- 2 
- 3 
- 4 
- 4 
- 1 
- 2 
- 2 
- 1 
- 3 

Rotate model

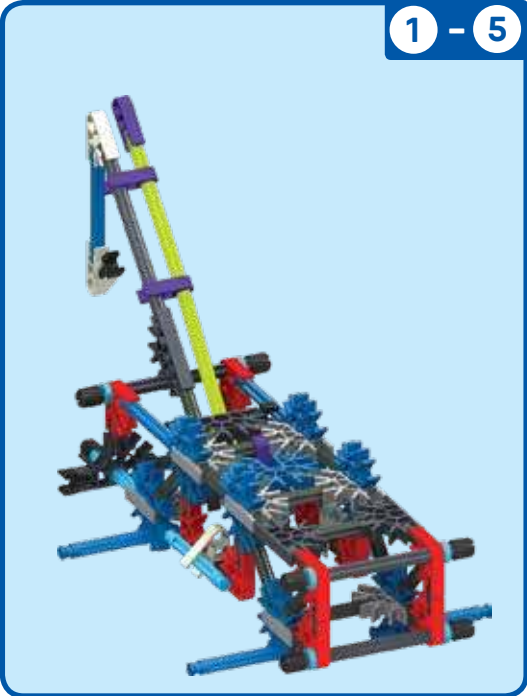
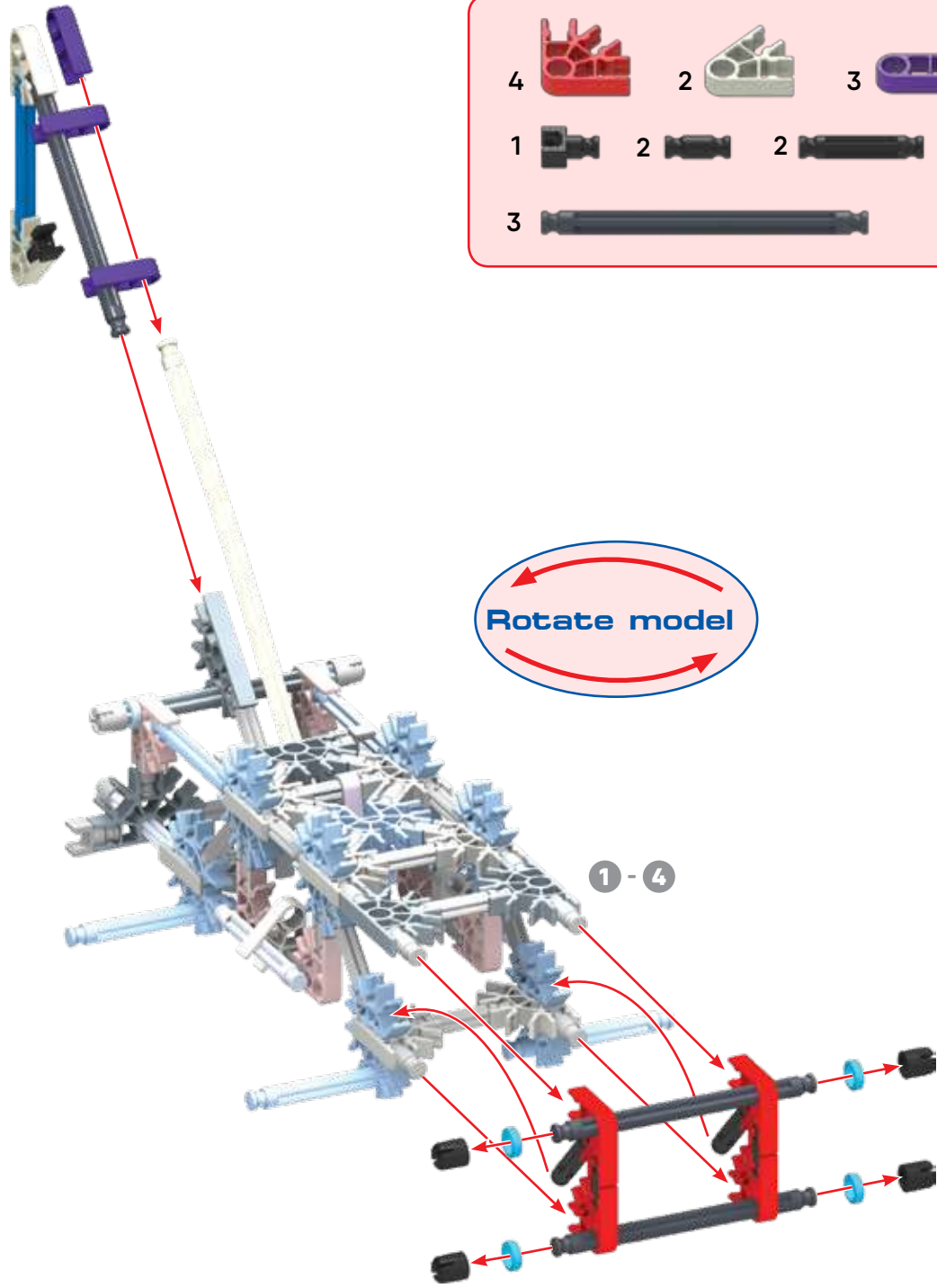

6

- 2 
- 2 
- 2 
- 6 
- 2 
- 4 
- 3 
- 2 
- 2 

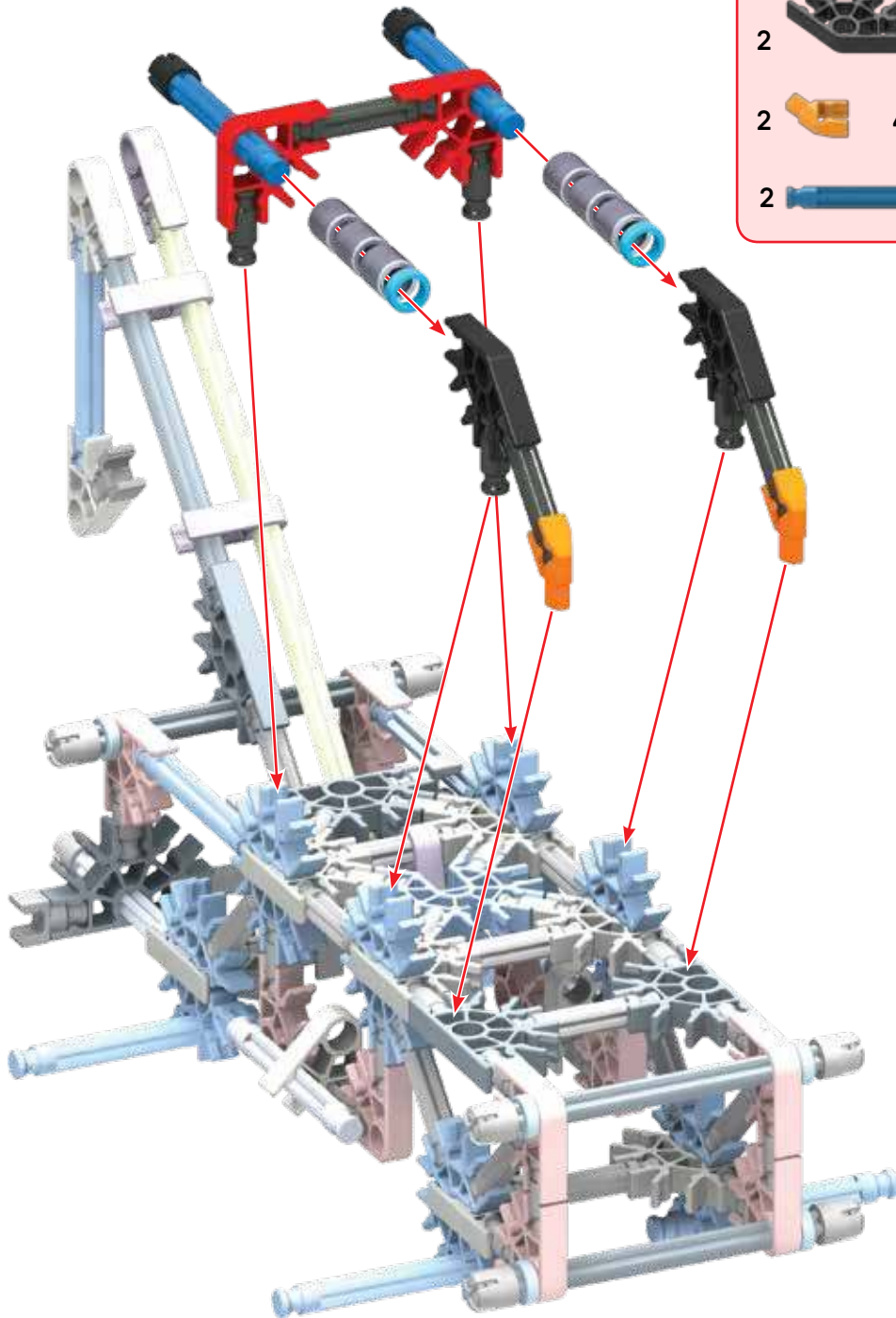

1 - 5

7

2 

4  4 

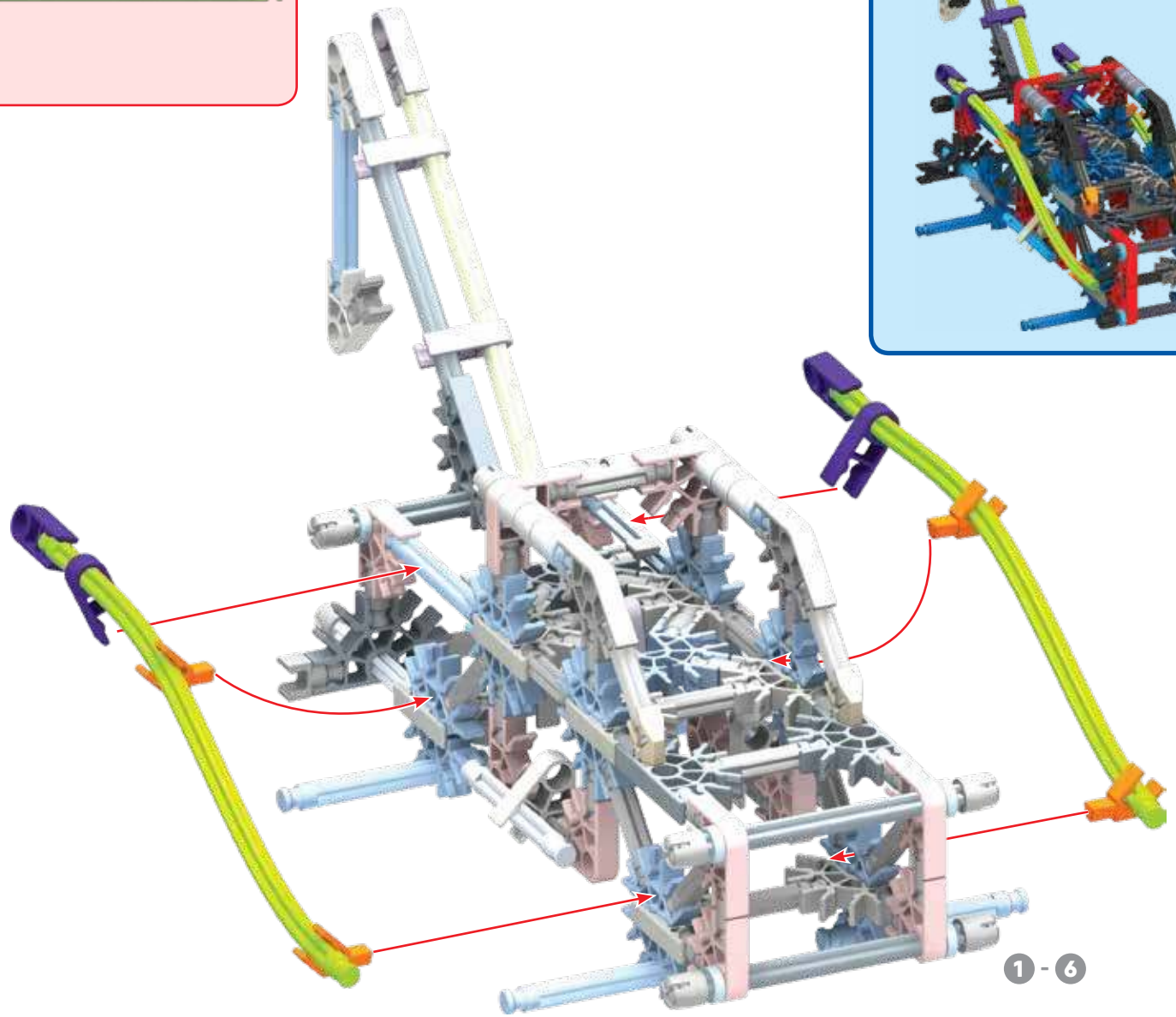

1 - 6

8

1 - 7

