

# pure acoustics®

## User's Manual for QBT-220



### Preface

Distinguished customer,

Thanks for choosing the Pure Acoustics QBT-220 Wireless Bluetooth Speaker. Before use, it will be rather helpful to read this manual carefully so that you can use it in an appropriate way. With stylish outer appearance, compact structure, high fidelity sound and multi-functionality, it has obtained patents concerning its outer appearance and adopted advanced electric and sound technology in the industry, ultimately making itself the best choice to hook up with your devices such as tablet, cell phone and digital music player etc. perfectly by presenting you exceptional stereo effect either you are at home, on vacation or at work..

#### **I. Precautions**

Please store and use this product at the ambient temperature;

Do not expose this product to the rain or damp surroundings;

Prevent this product from falling that could result in serious damage;

Do not dismantle, repair or modify this product on your own;

In order to avoid any risk, do not dispose this product inappropriately or toss it into the fire as there is a built-in lithium battery inside.

#### **II. Considerate Hints**

- 1) Do not turn up the volume to a fair high level constantly as this could shorten the service life of this product or impair your hearing.
- 2) When encountering any fault during operation, please cut off the power supply and disconnect the USB cable to prevent further damage to the speaker or other components.
- 3) The Bluetooth transmission range or connectivity could be affected by low battery power. In that case, please recharge immediately.

#### **III. Outer Appearance and Function Buttons**

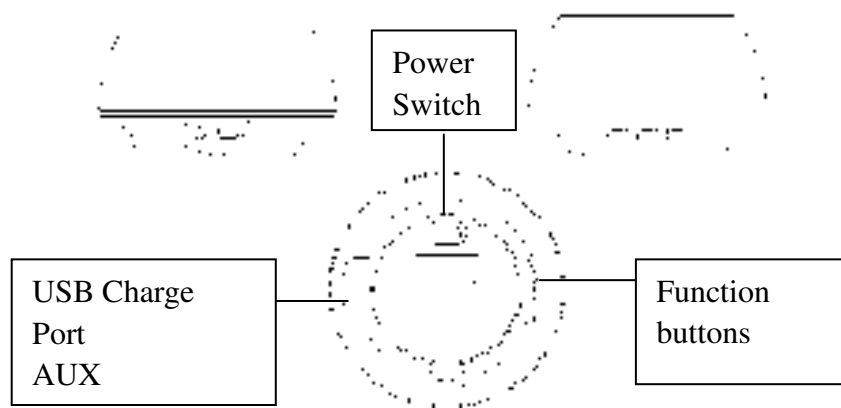

**1. /MODE:** play/pause/ mode.

During music playing, press it to pause; if it's paused, press it for playing; press it to change between, BLUETOOTH, AUX, FM, USB modes; under FM mode, press it for a long time for channels searching; press it to pause under AUX and re-press to play; under BLUETOOTH mode, press it to answer the call when call comes, re-press to hang off

**2. :** press it for a long time for volume decrease during music playing; short time press for last song. Under BLUETOOTH, it's only for volume decrease

**3. :** press it for a long time for volume increase during music playing; short time press for next song; under BLUETOOTH, it's only for volume increase

**IV. Features**

1. FM radio: search channels automatically and can save the channels for future use
3. with built-in Li battery, can be powered by USB cable or DC 5V USB cable
4. with power failure recovery function: automatically start from power off point when it's powered again
5. 3.5mm Aux cable, easy to connect with computer/MP3/MP4/IPOD/IPHONE...
6. Connected with computer through USB, the priority mode is to play music from computer. Aux cable is not needed.
7. Play music through bluetooth connection

**V. Product Parameters**

Product Model: QBT-220

Bluetooth Specifications: Bluetooth 3.0

Transmission Distance: ≤10M (depending on operation environment and devices to which it connects)

Impedence: 4Ω

Frequency Response: 90Hz-20KHz

Sensitivity: 80db±2db

Signal to Noise Ratio (SNR): ≥76dB

Output Power: 3W×1

Powered by Built-in Li battery/USB

Product size: φ62×76MM

**VI. Power**



Built-in Li battery/ USB/ USB DC5V

## VII. System Composition





- |    |                 |        |
|----|-----------------|--------|
| 1) | Speaker         | 1set   |
| 2) | 3.5 Audio Cable | 1piece |
| 3) | USB Cable       | 1piece |
| 4) | User's Manual   | 1copy  |

## VIII. Function Introduction

### 1) AUX mode

Connect the speaker with audio device like computer/MP3/MP4/IPOD/IPHONE, press  for 3 seconds to decrease volume,  for volume increase. Under AUX mode, press  for pause or playing

### 2) FM mode



Plug in AUX cable as signal antenna under FM mode. Press “Play/Pause” button for 3 seconds to search, save and delete channels. Press  for last channel,  for next channel. Press  for 3 seconds to increase volume,  to decrease volume.

### 3) BLUETOOTH mode

Change the mode into BLUETOOTH, blue light of the speaker will keep glistering. Switch on other bluetooth device like mobile, Laptop, etc to search for the speaker. When the speaker is found by the bluetooth device, match the 2 devices. If they're successfully matched, the speaker will beep. On the other hand, bluetooth device also displays information concerning successful connection. As the speaker is able to memorize the last paired device, it will automatically pair up with the device to which it connected successfully last time when turned on. If no bluetooth device is available after the speaker is shifted to BLUETOOTH mode for 5 minutes, bluetooth function of the speaker will close. For 2nd connection, please turn off the speaker, shift to BLUETOOTH mode and re-connect.



Remark: When connection fails, please double check if power is enough for the speaker; or turn off the speaker and switch on for trying again.

### 4) Music playing under BLUETOOTH mode

During music playing under BLUETOOTH mode, press  for a long time for volume decrease,  for volume increase.

Remark: When the speaker plays music through bluetooth connection, music choosing or pausing is done on bluetooth device like mobile, Laptop. You can't choose music or pause by the speaker.

### 5) Hands-free call answering

When the speaker is playing music from mobile through bluetooth, the speaker will beep if somebody calls your mobile. Press  on the speaker to answer the call with the speaker, repress  to hand off. In bluetooth connection, press  twice, the speaker can dial the last cellphone Number you called.

6) Switch on the speaker, connected with computer through USB, the priority mode is to play music from computer directly. AUX cable is not needed.

### 7) Recharge

Connect the speaker with computer through Mini USB, red light on the speaker will indicate it's been recharged. When red light is off, it's been 100% recharged.

### **IX. Compatibility**

Wireless: Devices configured with Bluetooth 3.0 or higher version such as IPAD, IPHONE (at least the second generation IPHONE installed the IPHONE software 3.1), IPOD TOUCH and MAC as well as a majority of intelligent phones or computers that support Bluetooth.

BLUETOOTH: V3.0 consists of protocols like: A2DP, AVRCP, HFP

### **X. Troubleshooting**

Faults	Solutions
Device does not turn on	(1) Connect speaker to power source
No signal under FM mode	(1) Check whether signal is available around (2) Check if Aux cable is plugged in as antenna
If signal around is not good, how to improve	(1) Plug Aux cable as outer antenna