

User Manual

LDMeter B40/B50/B60/B80/B100/B120

B

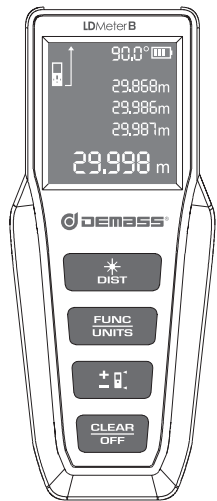

DEMSS

Laser Distance Meter

Product Information

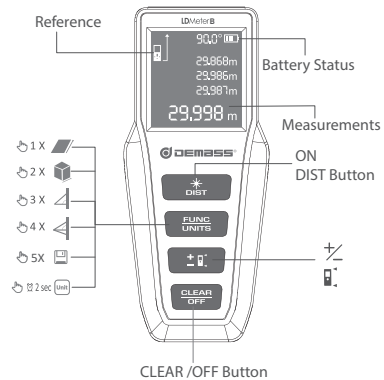

ON/OFF

- ON
- OFF (2 sec)
- CLEAR



2

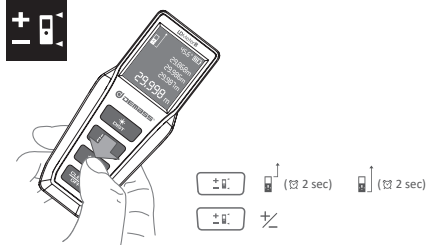

Unit

- 2 sec in
- 2 sec ft
- 2 sec ruler
- 2 sec m

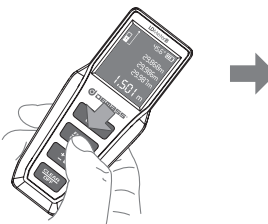

3

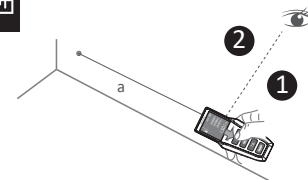

1 1 X

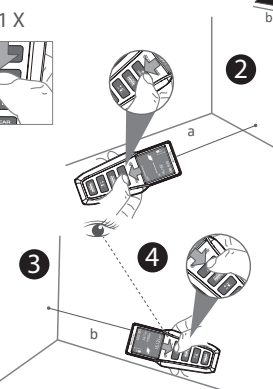

4



1 2 X

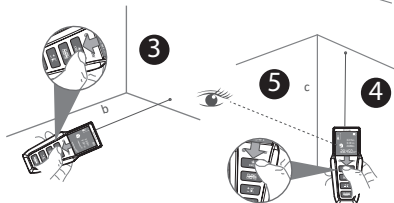
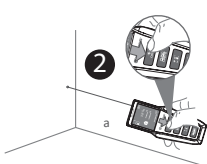

1 3 X

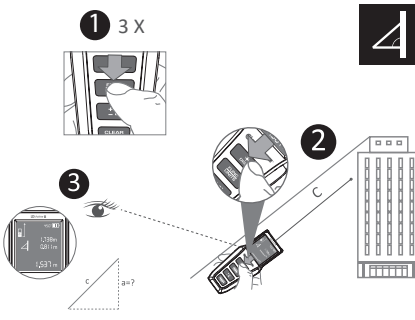

5

1 4 X

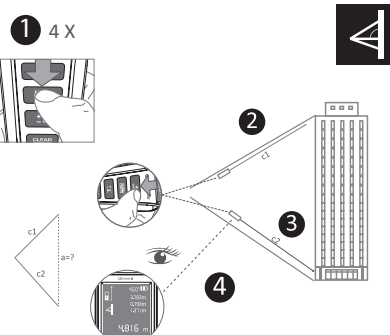

6



max
min

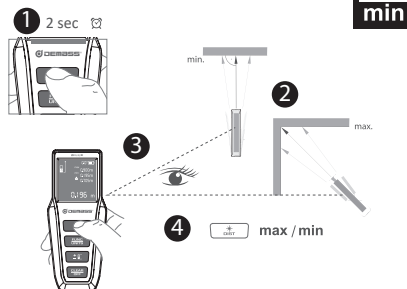

6

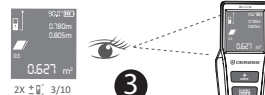

1 5 X

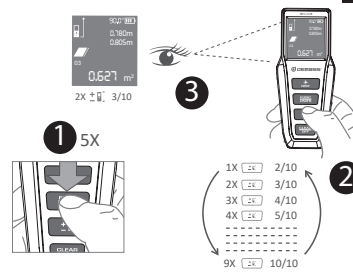

7

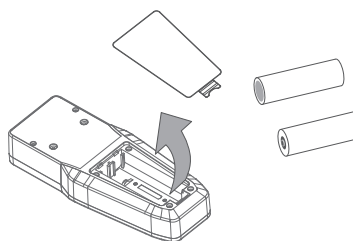

Technical Data

	B40	B50	B60	B80	B100	B120
	0.05-40m	0.05-50m	0.05-60m	0.05-80m	0.05-100m	0.05-120m
	±2mm					
	m, in, ft, ft/in, ruler					
	620-690nm					
	class2					
	0°C - 40°C					
	-20°C - 65°C					
	IP54					
	2X1.5V AAA LR03					
	30s 3min					
	119x49.5x22mm					
	68g					

LDMmter B Error Message Code

Message	Cause	Solution
203	Low battery	Replace
402	Calculation error	Make measurements in correct succession
301	Temperature is too high	Cool down the product external temperature will be available from 0°C to +40°C
302	Temperature is too low	Warm up the product external temperature will be available from 0°C to +40°C
101	Reflected signal is too weak	Use reflecting plate
102	Reflected signal is too strong	Use reflecting plate
201	Ambient light is too strong	Make measurements in less illuminated zone
202	Ambient light is too weak	Make measurements in less illuminated zone
401	Hardware error	Switch on/off the instrument several times if the symbol still appears then your instrument may be defective. Please call your dealer for assistance.

8

Safety Instructions

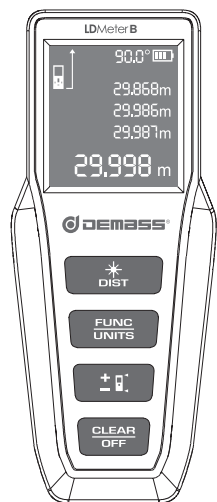

DEMASS
Laser Distance Meter

Symbols used

The following symbols are used to distinguish precautions by the degree of injury or damage that may happen if the precautions ignored.

WARNING:

Indicate a potentially hazardous situation or an unintended use which, if not avoided, will result in death or serious injury.

CAUTION:

Indicate a potentially hazardous situation or an unintended use which, if not avoided, will result in death or serious injury and/or in appreciable environment or property damages.

 Important instructions which must be adhered to in practice as they enable the product to be used in a technically correct and efficient manner.

Possible danger when use the device:

- The laser beam will harm eyes when aim to eyes directly.
- The device may produce a spark and light to dust or gas.
- When clean battery electrolyte, human fingers may be affected.
- The device may cause a hazardous radiation explosion.
- Laser exposure radiation damage.

Caution:

- Do not look straight into the laser beam.
- Do not use the device in inflammable and explosive environment.
- Remove the batteries to avoid the electrolyte leakage when not use the device.
- Do not try other functions that the device does not have itself.
- Do not attempt to alter the functions of the device in any way.

Maintenance:

Wipe off dirt with wet and soft cloth. If wet cloth does not work, use cloth with alcohol to clean the dirt. Be careful with the optical components (such as optical lens): wipe with clean soft cloth or cotton swab with distilled water (as cleaning glasses or camera lens). Do not use harmful cleaning material.

Permitted use

Measuring distance
Calculation functions, e. g., area and volume

Prohibited use

- . Using the instrument without reading instructions.
- . Using beyond the stated usage limits.
- . Damaging safety precaution system and removal of instruction and hazard labels.
- . Disassembling the equipment by using tools (screw drivers, etc.), as far as not specifically permitted for certain cases,
- . Carrying out modification or alteration to the product.
- . Using accessories from other manufacturers without the approval by our company.
- . Deliberate or irresponsible operation on scaffolding or when using ladders, when measuring near running machines or unprotected equipment.
- . Aiming directly at the sun.
- . Deliberately aim at other people's eyes, also in the dark.
- . Using at the surveying site without adequate safeguards (e. g. when measuring on roads, construction sites, etc.)

Limits use

See section "Technical Data".
The product is designed for use in the conditions permanently habitable for humans, do not use the product in corrosive or explosive environments.

Areas of responsibility

Original producer's responsibility:
Responsible for providing with safe products include manual and original parts.

Responsibilities of the manufacturer of non-original accessories:

The manufacturers of non-original accessories for the products are responsible for developing, implementing and communicating safety concepts for their products. They are also responsible for the effectiveness of these safety concepts in combination with the products equipment.

Responsibilities of the person in charge of the instrument:

WARNING:

The person responsible for the instrument must ensure to use and request other people to use the equipment following instructions. The person in charge of the instrument has the following duties:

- . To understand the safety instructions on the product and the instructions in the User Manual.
- . To be familiar with local safety regulations related to accident prevention.
- . To inform local dealer immediately if the equipment becomes unsafe.

Hazards in use

CAUTION:

Watch out for erroneous distance measurements if the instrument is defective or if it has been dropped or has been misused or modified.

Carry out periodic test measurements. Particularly after the instrument has been subject to abnormal use, before, during and after important measurements. Make sure the optical glasses are kept clean and that there is no mechanical damage to the instrument.

CAUTION:

When using the instrument for distance measurements or for positioning moving objects (e. g. cranes, building equipment, platforms, etc.), unforeseen circumstances may cause erroneous measurements.

Precautions:

Only use this product as a measuring device, not as a control device. Your system must be configured and operated in such a way, that in case of an erroneous measurement, malfunction of the device or power failure, it still can take safety measures (e. g. safety limit switch), so it is assured that no damage will occur.

WARNING:

Used batteries must not be disposed of with household waste. Please dispose of or recycle the used batteries according to related national or local regulations.

 Do not dispose of or recycle this product with household waste. Please recycle this product in a proper way. Dispose of or recycle this product according to related national or local regulations. Always prevent access to the product by unauthorized personnel. And take them to the collection points provided in accordance with national or local regulations.

For technical support, please contact your local dealers.

Electromagnetic Compatibility (EMC)

The term "electromagnetic compatibility" means the capability of the product to function smoothly in an environment where electromagnetic radiation and electrostatic discharges are present, and without causing electromagnetic interference to other equipment.

WARNING:

The product conforms to relevant standards and regulations. Yet, the possibility of it causing interference with other devices cannot be totally excluded.

CAUTION:

Never attempt to repair the product by yourself. In case of damage, contact the local dealer.

Laser classification
Integrated distance meter



It produces a visible laser beam which comes from the front of the instrument.

It is a Class 2 laser product in accordance with,
● IEC60825-1 : 2014 "Radiation safety of laser products" Laser Class 2 products:

Do not stare into the laser beam or direct it towards other people unnecessarily. Eyes will evade or blink by instinct for protection.

WARNING:

Looking directly into the laser beam with optical glasses (e. g. Binoculars, telescopes) can be hazardous.

Precautions:

Do not look directly into the beam with optical glasses.

CAUTION:

Looking into the laser beam may be hazardous to the eyes.

Precautions:

Do not look into the laser beam. Make sure the laser is aimed above or below eye level, particularly when fix the instrument on machines, etc.

 Thanks for purchase our products.

 Carefully read the Safety Instructions and the User Manual before using this product.

The person responsible for the instrument must ensure that all users read, understand and adhere to these instructions.