

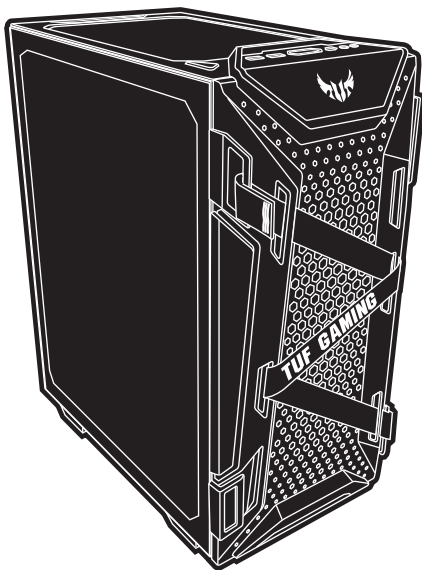

ASUS[®]
IN SEARCH OF INCREDIBLE



User Manual

TUF CASE **GAMING** **GT301**





**Copyright © 2019 ASUSTeK Computer Inc.
All Rights Reserved.**

No part of this manual, including the products and software described in it, may be reproduced, transmitted, transcribed, stored in a retrieval system, or translated into any language in any form or by any means, except documentation kept by the purchaser for backup purposes, without the express written permission of ASUSTeK Computer Inc. ("ASUS").

Product warranty or service will not be extended if: (1) the product is repaired, modified or altered, unless such repair, modification or alteration is authorized in writing by ASUS; or (2) the serial number of the product is defaced or missing.

ASUS PROVIDES THIS MANUAL "AS IS" WITHOUT WARRANTY OF ANY KIND, EITHER EXPRESS OR IMPLIED, INCLUDING BUT NOT LIMITED TO THE IMPLIED WARRANTIES OR CONDITIONS OF MERCHANTABILITY OR FITNESS FOR A PARTICULAR PURPOSE. IN NO EVENT SHALL ASUS, ITS DIRECTORS, OFFICERS, EMPLOYEES OR AGENTS BE LIABLE FOR ANY INDIRECT, SPECIAL, INCIDENTAL, OR CONSEQUENTIAL DAMAGES (INCLUDING DAMAGES FOR LOSS OF PROFITS, LOSS OF BUSINESS, LOSS OF USE OR DATA, INTERRUPTION OF BUSINESS AND THE LIKE), EVEN IF ASUS HAS BEEN ADVISED OF THE POSSIBILITY OF SUCH DAMAGES ARISING FROM ANY DEFECT OR ERROR IN THIS MANUAL OR PRODUCT.

SPECIFICATIONS AND INFORMATION CONTAINED IN THIS MANUAL ARE FURNISHED FOR INFORMATIONAL USE ONLY, AND ARE SUBJECT TO CHANGE AT ANY TIME WITHOUT NOTICE, AND SHOULD NOT BE CONSTRUED AS A COMMITMENT BY ASUS. ASUS ASSUMES NO RESPONSIBILITY OR LIABILITY FOR ANY ERRORS OR INACCURACIES THAT MAY APPEAR IN THIS MANUAL, INCLUDING THE PRODUCTS AND SOFTWARE DESCRIBED IN IT.

Products and corporate names appearing in this manual may or may not be registered trademarks or copyrights of their respective companies, and are used only for identification or explanation and to the owners' benefit, without intent to infringe.





Contents

Accessory Kit Contents 2

Installation Guide 3

Remove the Side Panels	4
Install the Power Supply Unit (PSU)	5
Install the Cooler & RAM on the Motherboard	6
Install the I/O Shield	7
Install the Motherboard Unit	8
Attach the Front I/O Connectors	9
Addressable RGB Controller Hub	10
Install the PCI-E Card	12
Install the 2.5" Drives	14
Install the 3.5" / 2.5" Drives	16
Installation and Maintenance of the Dust Filters	17
Install the Headphone Hanger	18

Additional Information 19









CPU Cooler Height Limitation	20
Graphics Card Limitation	21
Fan Setup Compatibility	22
Water-cooling Radiator Options	23

Safety Information 24



Accessory Kit Contents

配備零組件內容物 | 配备組件內容物 | Obsah sady příslušenství | Contenu du kit d'accessoires | Verpackungsinhalt des Zubehörsatzes | Accessori contenuti nel kit | アクセサリーキットの内容 | 액세서리 키트 내용물 | Zawartość zestawu akcesoriów | Conteúdo do kit de acessórios | Содержимое комплекта | Contenido del kit de accesorios | Tillbehörsatsens innehåll | Aksesuar Kitinin İçindekiler | محتويات طقم الملحقات

A		PSU / 3.5" Drive Screws	x8
B		Motherboard / 2.5" Drive Screws	x25
C		Standoff Tool	x1
D		Cable Ties	x8
E		Headphone Hanger	x1
F		Headphone Hanger Screw	x1
G		VGA Holder Rubbers	x2
H		Velcro Strap	x3



Installation Guide

安裝指南 | 安裝指南 | Instalační příručka | Guide d'installation | Installationsanleitung | Guida all'installazione | 組み立てガイド | 설치 설명서 | instrukcja instalacji | Manual de instalação | Руководство по установке | Guía de instalación | Installationsguide | Kurulum Kılavuzu | دليل التركيب





1 Remove the Side Panels

移除側面板 | 移除側面板 | Sejměte boční panely | Retirer les panneaux latéraux | Entfernen der Seitenwände | Rimuovete i pannelli laterali | サイドパネルを取り外す | 측면 패널 제거 | Zdejmij panele boczne | Remover os painéis laterais | Снимите боковые панели | Quite los paneles laterales | Ta bort sidopanelerna | Yan Panelleri Çıkarm | ازل اللوحات الجانبية



1

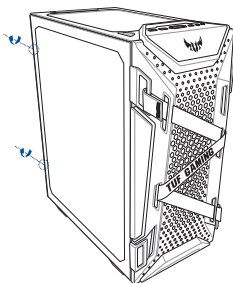

2

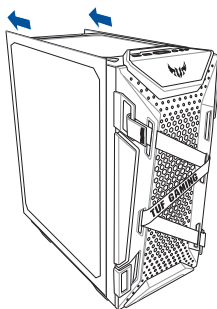

2 Install the Power Supply Unit (PSU)

安裝電源供應器 | 安裝電源供應器 | Nainstalujte zdroj napájení (PSU) | Installer le bloc d'alimentation | Installation des Netzteils | Installate l'alimentatore (PSU) | 電源装置を取り付ける | 전원 공급장치(PSU) 설치 | Zainstaluj zasilacz (PSU) | Instalar a fonte de alimentação (PSU) | Установите блок питания | Instalar la fuente de alimentación (PSU) | Sätt i strömförsörjningsenheten (PSU) | Güç Kaynağı Ünitesini (PSU) Takın | (PSU) ركّب وحدة الإمداد بالطاقة



x4

1

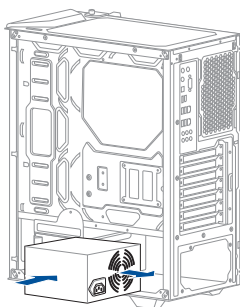

2

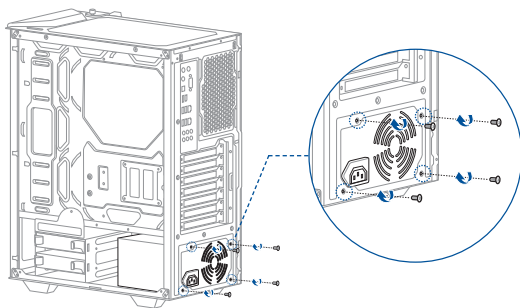

5



3 Install the Cooler & RAM on the Motherboard

安裝主機板散熱器和記憶體 | 安裝主板散熱器和內存卡 | Nainstalujte chladič a paměť RAM na základní desku | Installez le refroidisseur et la mémoire RAM sur la carte mère | Installation des Kühlers und der RAM-Module auf das Motherboard | Installate dissipatore e RAM sulla scheda madre | CPU、クーラー、メモリーをマザーボードに取り付ける | 메인보드에 쿨러 및 RAM 설치 | Zainstaluj element chłodzący i pamięć RAM na płycie głównej | Instalar o dissipador e memória RAM na placa principal | Установите на материнскую плату кулер и память | Instalar el refrigerador y la memoria RAM en la placa base | Montera kylare och RAM på moderkortet | Soğutucu ve RAM'i Anakarta Takin | ركب المبرد وذاكرة الـ (RAM) باللوحة الأم

1

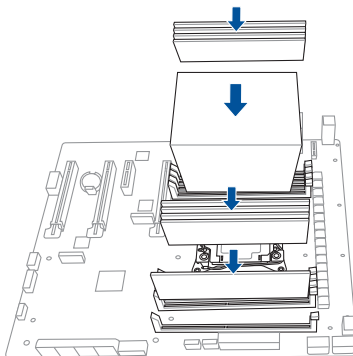

2

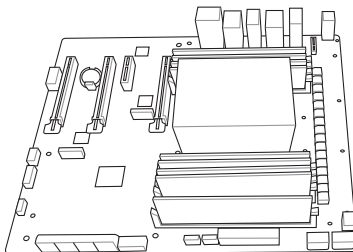



4 Install the I/O Shield

安裝 I/O 擋板 | 安裝 I/O 擋板 | Nainstalujte I/O štít | Installer le cache d'E/S | Installation der E/A-Blende | Installate la mascherina I/O | I/Oシールドを取り付ける | I/O 쉴드 설치 | Zainstaluj osłonę portów We/Wy | Instalar a tampa de E/S | Установите заглушку разъемов ввода-вывода | Instalar la protección de ES/ | Installera I/O-skölden | G/Ç Korumucuyu Takın | ركب غطاء الإدخال/الإخراج

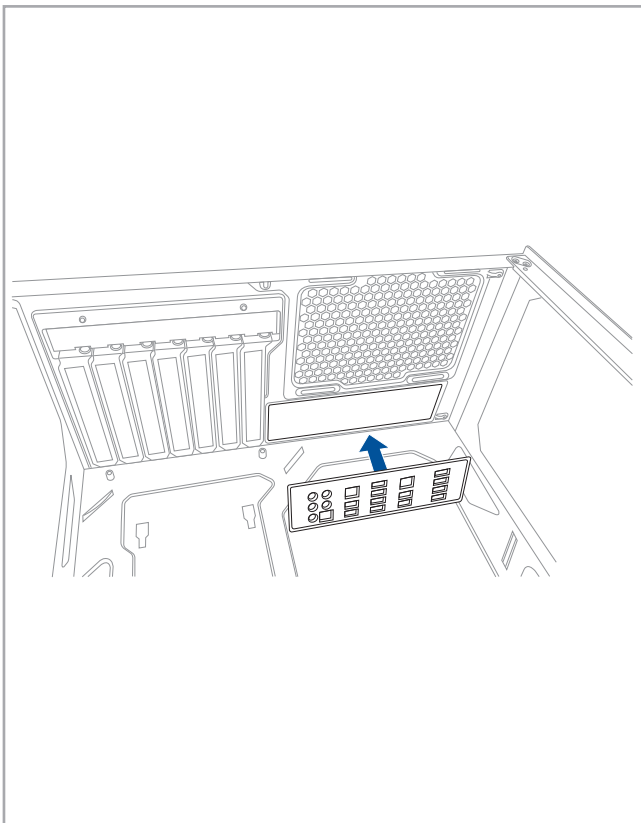

7





5 Install the Motherboard Unit

將主板裝入機殼 | 將主板裝入機箱 | Nainstalujte základní desku | Installer la carte mère | Installation der Motherboard-Baugruppe | Installate la scheda madre | マザーボードを取り付ける | 메인보드 유닛 설치 | Zainstaluj płytę główną | Instalar a placa principal | Установите материнскую плату | Instalar la unidad de la placa base | Installera moderkortsheten | Anakart Ünitesini Takın | تركيب وحدة اللوحة الأم



B



x9

1

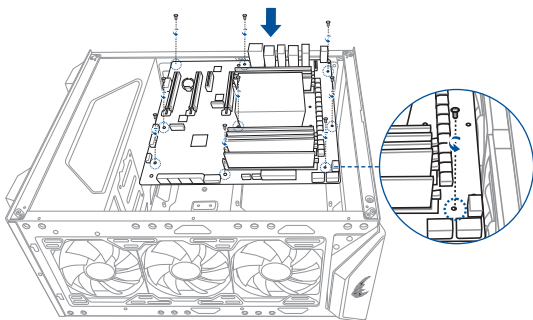

2

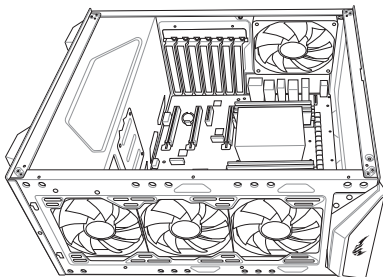

6 Attach the Front I/O Connectors

連接前面板 I/O 插孔 | 连接前面板 I/O 插孔 | Připojte přední I/O konektory | Fixer les connecteurs d'E/S avants | Befestigen der vorderen E/A-Anschlüsse | Collegare i connettori di I/O frontali | フロント I/O コネクターを取り付ける | 전면 I/O 커넥터 연결 | Zamocuj przednie złącza We/Wy | Encaixar os conectores de E/S frontais | Подключите разъемы для передней панели | Acoplar los conectores de E/S frontales | Anslut de främre I/O-kontakterna | Ön G/C Konektörlerini Takın | وصل موصلات الإدخال/الإخراج الأمامية

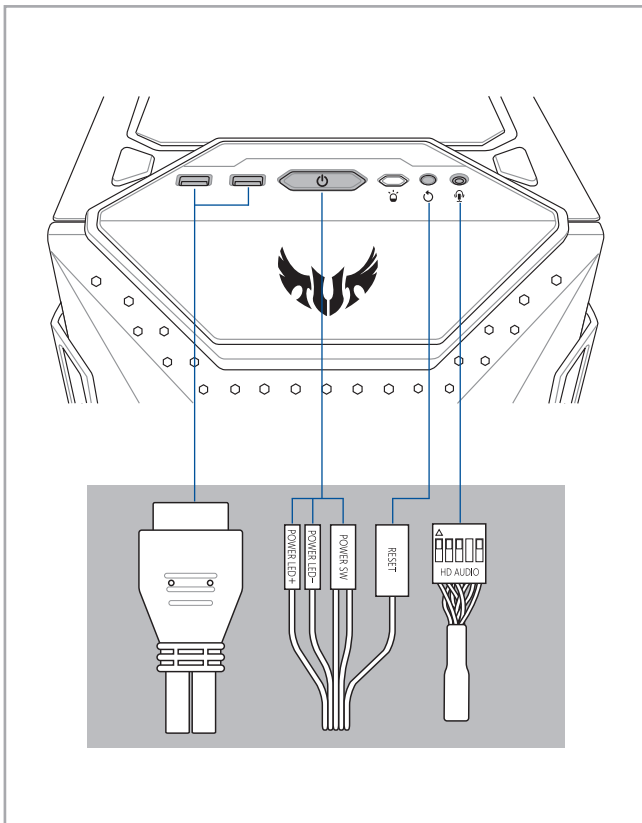

7 Addressable RGB Controller Hub

風扇集線器 | 風扇集線器 | Možnosti připojení rozbočovače ventilátoru | Connectivité du hub pour ventilateur | Verbindungsfähigkeit der Lüfternabe | Connettività dell'hub per ventole | ファンハブの接続方法 | 주소 지정이 팬 허브 연결 | Połączenia koncentratora wentylatorów | Conectividade de hub de ventiladores | Подключение концентратора для вентиляторов | Conectividad del concentrador del ventilador | Hubbanslutning för fläkt | Fan Göbeği Bağlanabilirliği | توصيلات المروحة

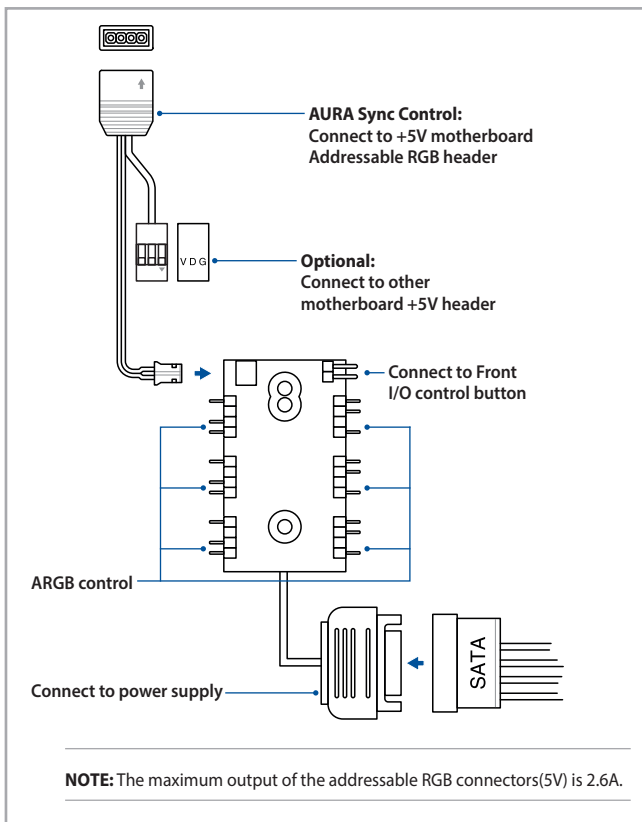

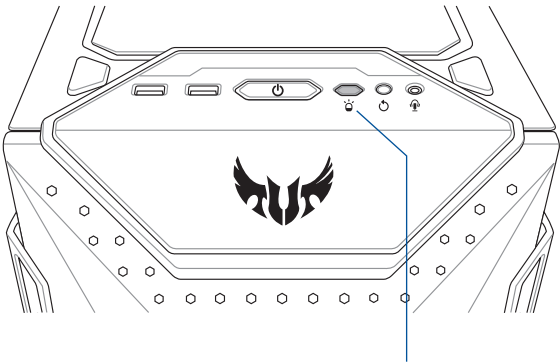

Turn On:	Press the LED button if the fan LEDs are off.
Turn Off:	Press the LED button for 3 seconds
Default:	Rainbow pattern.
Multi-pattern Change:	Press the LED button for 0.5 seconds. (Please refer to www.asus.com for more details)
AURA Sync (Change to MB Mode):	Press the LED button for 5 seconds. The fan LED will turn off, then blink Green 2 times rapidly. <ul style="list-style-type: none">• MB Mode only works when the control board is connected to the motherboard's Addressable RGB header.• Compatible with AURA Sync.



8 Install the PCI-E Card

安裝 PCI-E 卡 | 安裝 PCI-E 卡 | Nainstalujte PCI-E kartu | Installer la carte PCI-E | Installation der PCI-E-Karte | Installate la scheda PCI-E | 拡張カードを取り付ける | PCI-E 카드 설치 | Zainstaluj kartę PCI-E | Instalar a placa PCI-E | Установите карту PCI-E | Instalar la tarjeta PCI-E | Installera PCI-E-kortet | PCI-E Kartını Takın | تركيب بطاقة PCI-E



G



1

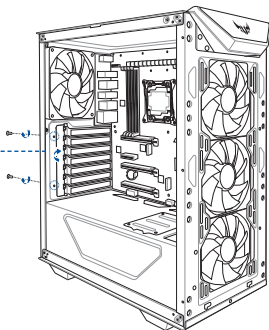
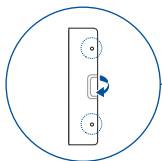

2

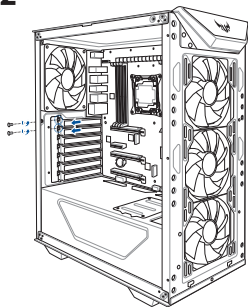

3

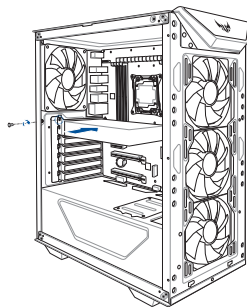



4

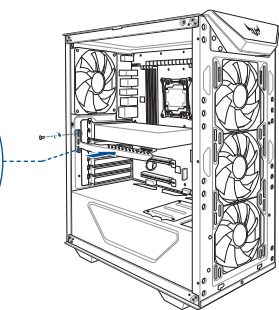
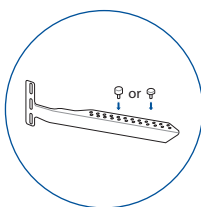

5

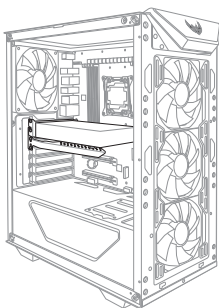

9 Install the 2.5" Drives

安裝2.5吋硬碟或固態硬碟 | 安裝 2.5 英寸硬盤或固態硬盤 | Nainstalujte 2,5" jednotky | Installer les lecteurs 2,5" | Installation der 2,5-Zoll-Laufwerke | Installate i drive 2.5" | 2.5インチドライブを取り付ける | 2.5" 드라이브 설치 | Zainstaluj napędy 2,5" | Instalar as unidades de 2,5" | Установите 2,5-дюймовые диски | Instalar las unidades de 2,5" | Installera 2,5"-enheterna | 2,5" sürücülerini Takın | ركب القرص الصلب مقاس 2.5 بوصة



B



x8

1

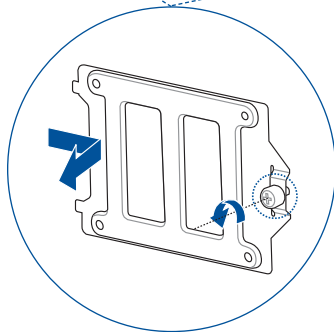
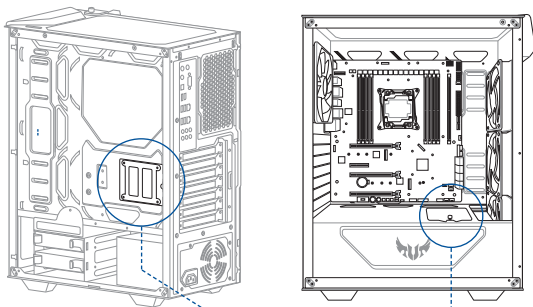



2

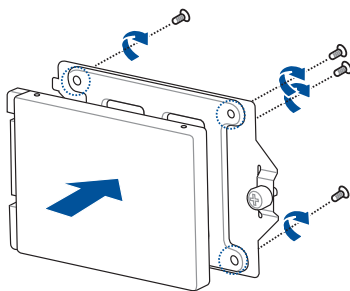

3

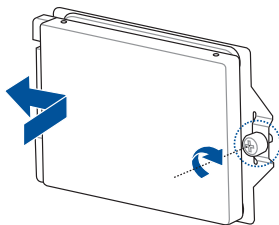

10 Install the 3.5" / 2.5" Drives

安裝 3.5 / 2.5 吋硬碟 | 安裝 3.5 / 2.5 英寸硬盤 | Nainstalujte 3,5"/2,5" jednotky | Installer les lecteurs 3,5"/2,5" | Installation der 3,5-Zoll-/2,5-Zoll-Laufwerke | Installate i drive 3,5"/2,5" | 3.5インチ/2.5インチドライブを取り付ける | 3.5"/2.5" 드라이브 설치 | Zainstaluj napędy 3,5"/2,5" | Instalar as unidades de 3,5"/2,5" | Установите 3,5/2,5-дюймовые диски | Instalar las unidades de 3,5"/2,5" | Installera 3,5"/2,5"-enheterna | 3,5"/2,5" Sürücülerini Takın | ركب القرص الصلب مقاس 2.5/3.5 بوصة



x2



x4

1

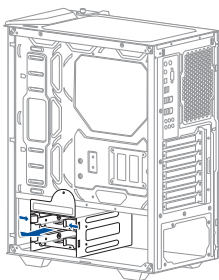

2

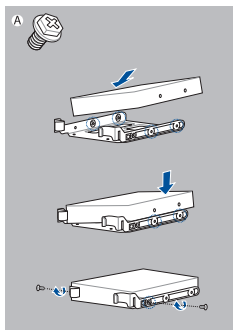

or

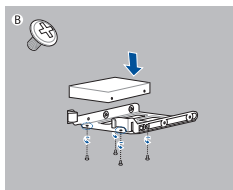

3

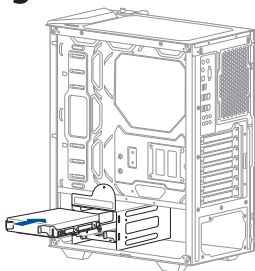

11 Installation and Maintenance of the Dust Filters

防塵網安裝及保養 | 防尘网安装及保养 | Instalace a údržba prachových filtrů | Installation et entretien des filtres à poussière | Installation und Wartung der Staubfilter | Installazione e manutenzione dei filtri antipolvere | ダストフィルターを取り付ける | 먼지 필터의 설치 및 유지보수 | Instalacja i konserwacja filtrów antykurzowych | Instalação e manutenção dos filtros de pó | Установка и обслуживание пылевых фильтров | Instalación y mantenimiento de los filtros de polvo | Installation och underhåll av dammfiltren | Toz Filtrelerinin Kurulumu ve Bakımı | تركيب وصيانة فلاتر الغبار

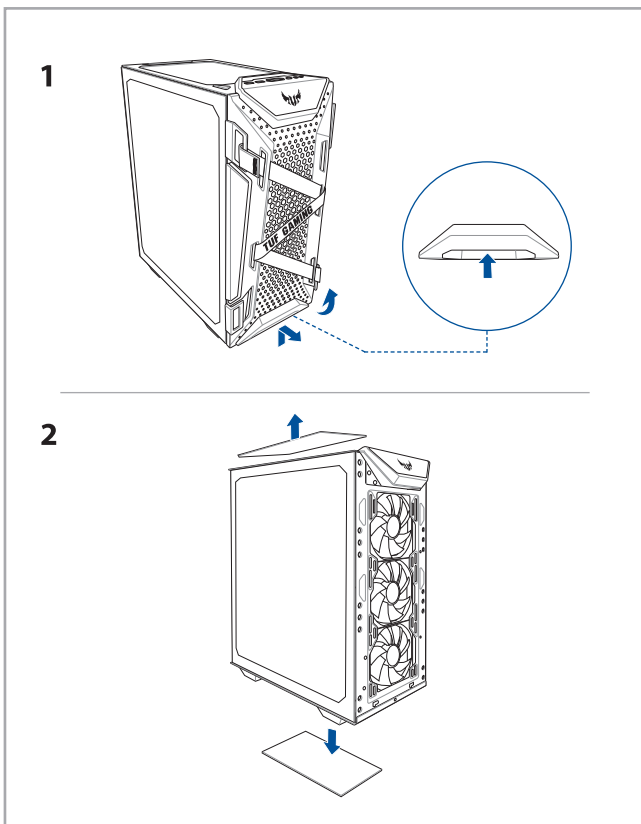



12 Install the Headphone Hanger

Install the Headphone Hanger | Install the Headphone Hanger | Install the Headphone Hanger | Install the Headphone Hanger | Install the Headphone Hanger | Install the Headphone Hanger | Install the Headphone Hanger | Install the Headphone Hanger | Install the Headphone Hanger | Install the Headphone Hanger | Install the Headphone Hanger | Install the Headphone Hanger

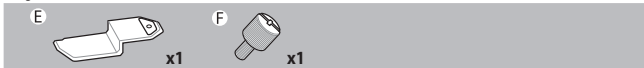

1

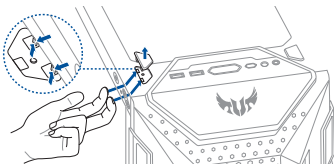

2

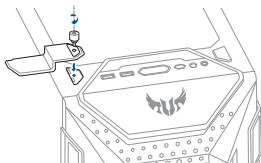

3

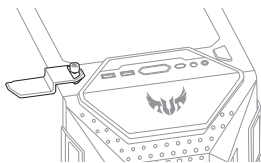



Additional Information

附加資訊 | 附加信息 | Dodatečné informace | Informations supplémentaires | Zusätzliche Informationen | Informazioni addizionali | 追加情報 | 추가 정보 | Informacje dodatkowe | Informações adicionais | Дополнительная информация | Información adicional | Ytterligere information | Ek Bilgiler | معلومات إضافية





CPU Cooler Height Limitation

CPU 散热器高度限制 | CPU 散热器高度限制 | Výškové omezení chladiče CPU | Limitation de hauteur du refroidisseur pour processeur | Höhenbegrenzung des CPU-Kühlers | Limitazioni di altezza per il dissipatore CPU | CPUクーラーの制限 | CPU 쿨러 높이 제한 | Ograniczenie wysokości elementu chłodzącego CPU | Limitação de altura do dissipador da CPU | Ограничения для высоты процессорного кулера | Limitación de la altura del refrigerador de la CPU | Höjdbegränsning av CPU-kylare | CPU Soğutucu Yükseklik Sınırlaması | حد ارتفاع وحدة المعالجة المركزية

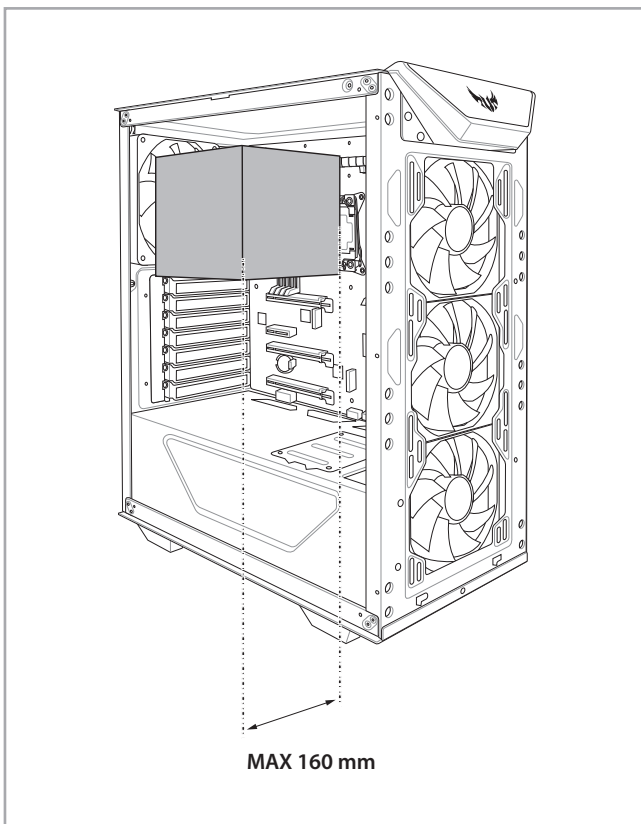



Graphics Card Limitation

顯示卡長度限制 | 显卡长度限制 | Omezení grafické karty | Limitations de la carte graphique | Beschränkungen der Grafikkarte | Limitazioni per la scheda grafica | グラフィックスクードの制限 | 그래픽 카드 제한 | Ograniczenia karty graficznej | Limitações de placas gráficas | Ограничения для видеокарты | Limitaciones de la tarjeta gráfica | Begränsningar för grafikkort | Grafik Kartı Sınırlamaları | حدود بطاقة الرسومات

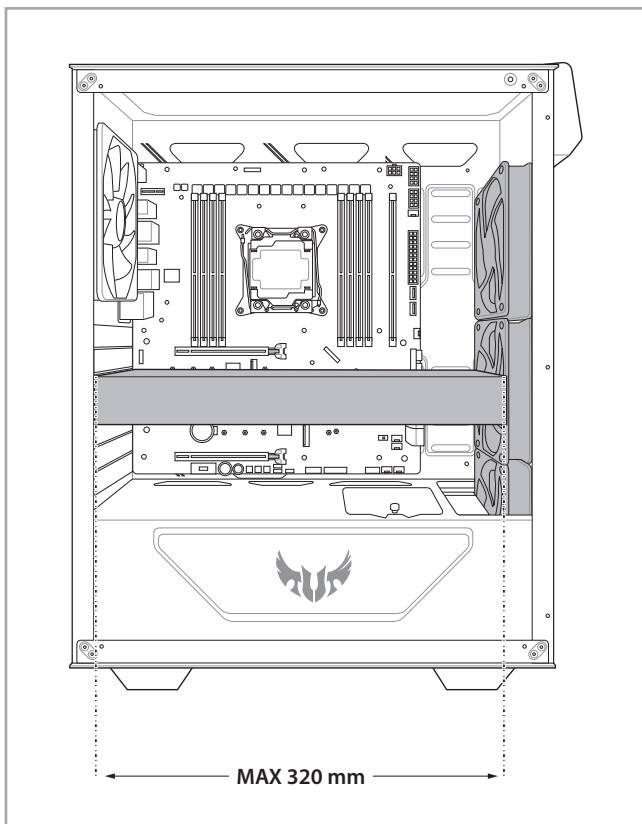

21



Fan Setup Compatibility

風扇設定相容性 | 风扇设置兼容性 | Kompatibilita nastavení ventilátoru | Compatibilité de configuration du ventilateur | Kompatibilität der Lüftereinrichtung | Specifiche di installazione per le ventole | ファンの取り付け例 | 팬 설치 호환성 | Zgodność instalacji wentylatora | Compatibilidade de ventiladores | Совместимость устанавливаемого вентилятора | Compatibilidad de la configuración del ventilador | Kompatibilitet för fläktinstallation | Fan Kurulumu Uyumluluğu | توافق إعداد المروحة

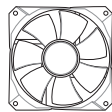
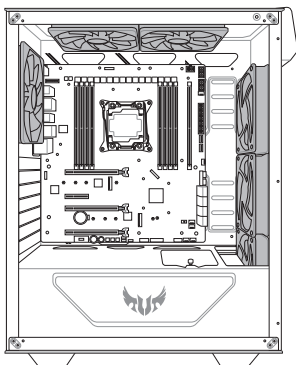

120 mm x 6

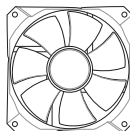
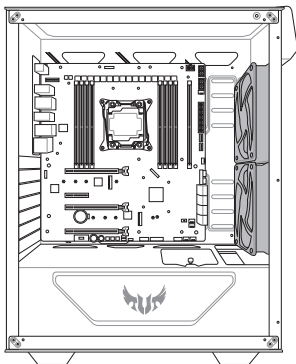

140 mm x 2

Water-cooling Radiator Options

水冷散熱系統選項 | 水冷散熱系統選項 | Možnosti chladiče vodního chlazení | Options de radiateur à refroidissement par eau | Optionen der Wasserkühlung | Opzioni per radiatore raffreddamento a liquido | 水冷ラジエーターの制限 | 수냉식 라디에이터 옵션 | Opcje instalacji radiatora chłodzonego wodą | Opções de radiadores de refrigeração a água | Варианты радиатора для водяного охлаждения | Opciones del radiador de refrigeración por agua | Alternativ för vattenkylningselement | Su Soğutma Radyatörü Seçenekleri | خيارات مشع تبريد المياه

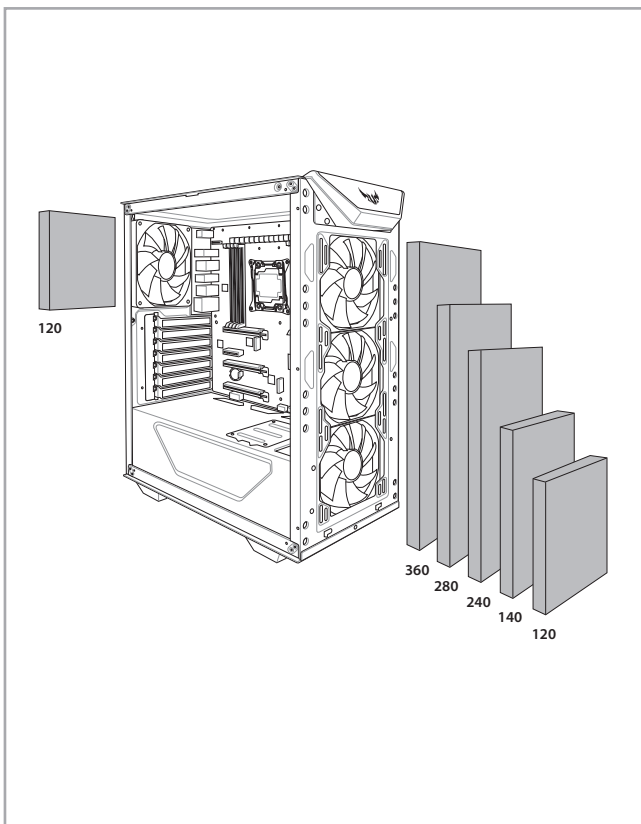



Safety Information

安規資訊 | 安規信息 | Bezpečnostní informace | Informations relatives à la sécurité | Sicherheitsinformationen |
Informazioni sulla sicurezza | 製品の安全性に関する情報 | 안전 정보 | Informacje dotyczące bezpieczeństwa |
Informações de segurança | Информация о правилах безопасности | Información de seguridad | Säkerhetsinformation |
Güvenlik Bilgileri | معلومات السلامة





ASUS Recycling/Takeback Services

ASUS recycling and takeback programs come from our commitment to the highest standards for protecting our environment. We believe in providing solutions for you to be able to responsibly recycle our products, batteries, other components, as well as the packaging materials.

Please go to <http://csr.asus.com/english/Takeback.htm> for the detailed recycling information in different regions.

Australia statement notice

From 1 January 2012 updated warranties apply to all ASUS products, consistent with the Australian Consumer Law. For the latest product warranty details please visit <https://www.asus.com/support/>. Our goods come with guarantees that cannot be excluded under the Australian Consumer Law. You are entitled to a replacement or refund for a major failure and compensation for any other reasonably foreseeable loss or damage. You are also entitled to have the goods repaired or replaced if the goods fail to be of acceptable quality and the failure does not amount to a major failure.

If you require assistance please call ASUS Customer Service 1300 2787 88 or visit us at <https://www.asus.com/support/>.

India RoHS

This product complies with the "India E-Waste (Management) Rules, 2016" and prohibits use of lead, mercury, hexavalent chromium, polybrominated biphenyls (PBBs) and polybrominated diphenyl ethers (PBDEs) in concentrations exceeding 0.1% by weight in homogenous materials and 0.01% by weight in homogenous materials for cadmium, except for the exemptions listed in Schedule II of the Rule.



REACH

Complying with the REACH (Registration, Evaluation, Authorisation, and Restriction of Chemicals) regulatory framework, we published the chemical substances in our products at ASUS REACH website at <http://csr.asus.com/english/REACH.htm>. (English)

謹遵守REACH(Registration, Evaluation, Authorisation, and Restriction of Chemicals)管理規範。我們會將產品中的化學物質公告在華碩REACH網站。詳細請參考<http://csr.asus.com/english/REACH.htm>。(繁體中文)

谨遵守REACH(Registration, Evaluation, Authorisation, and Restriction of Chemicals)管理规范。我们会将产品中的化学物质公告在华硕REACH网站。详细请参考<http://csr.asus.com/english/REACH.htm>。(简体中文)

V rámci shody s regulativní platformou REACH (Registration, Evaluation, Authorisation, and Restriction of Chemicals (registrace, hodnocení, povolení a omezení chemických látek) byl zveřejněn seznam chemických látek přítomných našich produktech na webu ASUS REACH na adrese <http://csr.asus.com/english/REACH.htm>. (Čeština)

Conforme avec le Règlement REACH (Enregistrement, Évaluation, Autorisation et Restriction des produits chimiques), nous avons publié la liste des substances chimiques utilisées dans nos produits sur le site Web ASUS REACH à l'adresse <http://csr.asus.com/english/REACH.htm>. (Français)

Die rechtliche Rahmenbedingungen für REACH (Registration, Evaluation, Authorisation, and Restriction of Chemicals) erfüllend, veröffentlichen wir die chemischen Substanzen in unseren Produkten auf unserer ASUS REACH-Webseite unter <http://csr.asus.com/english/REACH.htm>. (Deutsch)

Nel rispetto del regolamento REACH (Registration, Evaluation, Authorisation, and Restriction of Chemicals), le sostanze chimiche contenute nei prodotti ASUS sono state pubblicate nel sito web ASUS, alla pagina: <http://csr.asus.com/english/REACH.htm>. (Italiano)

REACH (Registration, Evaluation, Authorisation, and Restriction of Chemicals) 規則の基準を満たすため、ASUSは REACH専用サイトで弊社製品に含まれる化学物質を公開しております。 <http://csr.asus.com/english/REACH.htm>. (日本語)

REACH (Registration, Evaluation, Authorisation, and Restriction of Chemicals: 등록, 평가, 승인 및 화학물질규제) 규제 기준을 준수하여 ASUS REACH 웹사이트 <http://csr.asus.com/english/REACH.htm> 에 당사 제품에서 사용된 화학 물질을 게시했습니다 (한국어)

Zgodnie z rozporządzeniem REACH (Rejestracja, ocena, autoryzacja i ograniczenie środków chemicznych), publikujemy informacje o środkach chemicznych w naszych produktach, na stronie internetowej ASUS REACH pod adresem <http://csr.asus.com/english/REACH.htm> (Polski)

Cumprindo o quadro regulamentar REACH (Registo, Avaliação, Autorização e Restrição dos Produtos Químicos), divulgamos as substâncias químicas incluídas nos nossos produtos no Web site ASUS REACH em <http://csr.asus.com/english/REACH.htm>. (Português)

Согласно регламенту ЕС REACH (Registration, Evaluation, Authorization, and Restriction of Chemicals – Регистрация, Оценка, Разрешения и Ограничения на использование Химических веществ), на сайте ASUS REACH размещен список химических веществ содержащихся в наших продуктах: <http://csr.asus.com/english/REACH.htm>. (Русский)

En cumplimiento del marco reglamentario REACH (registro, evaluación, autorización y restricción de productos químicos), hemos publicado las sustancias que contienen nuestros productos a través del sitio web ASUS REACH, al que puede acceder a través de la dirección <http://csr.asus.com/english/REACH.htm>. (Español)

Uppfyller REACH (Registration, Evaluation, Authorization, and Restriction of Chemicals (Registrering, Värdering, Behörighet och Begränsning)) reglerande regelverk, vi publicerar de kemiska substanserna i våra produkter på ASUS REACH webbsida på <http://csr.asus.com/english/REACH.htm>. (Svenska)

REACH (Kimyasalların Kayıt Alınması, Değerlendirilmesi, Ruhsatlandırılması ve Sınırlanması) düzenleyici çerçevesine uygun olarak, ürünlerimizdeki kimyasal maddeleri <http://csr.asus.com/english/REACH.htm> adresindeki ASUS REACH websitesinde yayınlamaktayız. (Türkçe)



电子电气产品有害物质限制使用标识：图中之数字为产品之环保使用期限。仅指电子电气产品中含有的有害物质不致发生外泄或突变，从而对环境造成污染或对人身、财产造成严重损害的期限。

有害物质名称及含量说明标示：

部件名称	有害物质					
	铅 (Pb)	汞 (Hg)	镉 (Cd)	六价铬 (Cr ⁶⁺)	多溴联苯 (PBB)	多溴二苯醚 (PBDE)
机箱组	×	○	○	○	○	○
面板组	×	○	○	○	○	○
I/O模组	×	○	○	○	○	○
风扇	×	○	○	○	○	○
零件包	×	○	○	○	○	○

本表格依据 SJ/T 11364 的规定编制。
 ○：表示该有害物质在该部件所有均质材料中的含量均在 GB/T 26572 规定的限量要求以下。
 ×：表示该有害物质至少在该部件的某一均质材料中的含量超出 GB/T 26572 规定的限量要求，然该部件仍符合欧盟指令 2011/65/EU 的规范。
 备注：此产品所标示之环保使用期限，系指在一般正常使用状况下。

AEEE Yönetmeliğine Uygundur.





TUF GAMING

