

User Manual

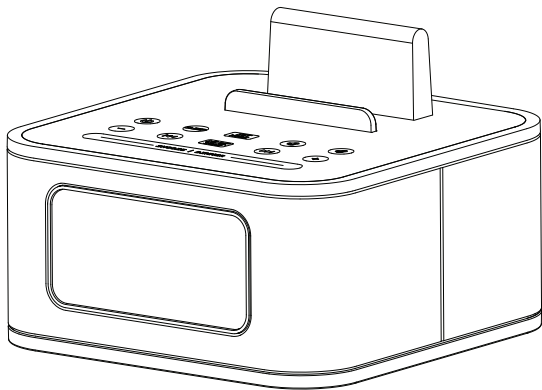

S1-BT

Bluetooth Speaker with Alarm Clock
and FM Radio

Safety Information

IMPORTANT:

Please read all safety instructions before proceeding. The answers to most set up and performance questions can be found in this manual. If you have any further questions about the operation or use of this product, please contact our customer service team for assistance before returning it to the place of purchase.

IMPORTANT SAFETY INSTRUCTIONS

1. All safety and operation instructions should be read thoroughly before attempting to operate this unit.
2. Please keep this handbook for future reference.
3. All warnings on this unit and in the operating instructions should be adhere to.
4. All operating and use instructions should be followed.
5. To prevent the risk of electric shock, do not remove the cover or back. Please refer all serving to qualified service personnel.

6. Do not expose the unit to liquid or solvent.
7. Do not expose the unit to temperature or humidity extremes, direct sunlight, excessive dust, or vibrations.
8. Place the unit on a stable surface. Do not drop, apply excessive force to the controls, or put heavy objects on top of it.
9. If cleaning is required, use a soft dry cloth. If necessary, please use a damp cloth without solvent.
10. Please do not place the unit near a fluorescent or neon light.
11. Although the unit are magnetically shielded, please keep the magnetic memory medium (eg: disks or tapes) at least four inches away from the unit to avoid data loss.
12. **WARNING:** To reduce the risk of fire or electric shock, do not expose the unit to rain or moisture.
13. Use only this approved power supply, otherwise it may cause danger.
14. Only use attachments/accessories specified by the manufacturer.

Content

1. Product Features	1
2. What is included.....	1
3. Specification Parameters.....	2
4. Diagram of the LCD Display & the Buttons.....	3
5. Operating Instruction.....	5
5.1 Power ON.....	5
5.2 Set Time.....	5
5.3 Set Alarm Time.....	5
5.4 Alarm Function.....	6
6. SLEEP Function under ON Model.....	6
7. Play Music from Mobile via Bluetooth.....	7
7.1 Operation.....	7
7.2 Answer the Phone.....	7
7.3 Hang up.....	7
7.4 Play Music.....	7
8. FM Radio Operation.....	8
9. Play Music from Aux Jack.....	8
10. Back-up Button Battery.....	8

1. Product Features

- (1) Elegant and fashionable design; simple setting
- (2) Bluetooth speakerphone for conference calls
- (3) 3.2 inch LCD display screen
- (4) FM Digital Radio
- (5) 3.5mm audio jack for connecting other audio sources
- (6) Stereo speaker, providing superior quality sound
- (7) USB port allows for traditional USB Charging for most devices on the market
- (8) Dual Alarms

2. What is included

Open S1's box, and you will find

S1 Body Unit	1	PC
Power Adaptor	1	PC
User Manual	1	PC
Audio Cable	1	PC

3. Specification Parameters

- Bluetooth Version: 4.0
- Bluetooth Profiles: A2DP, AVRCP, HFP, HSP
- Receive range: Up to 10 meters
- Operation Voltage: DC 5V 2.5A
- Output Power: 3W + 3W
- Driver Unit: 4Ω 3W 2 in
- Frequency range: 40Hz-20KHz
- S/N Ratio: >65dB
- Distortion Rate: <1%
- FM Frequency Range: 87.5 ~ 108MHz
- USB Port: DC 5V 1A
- Product Net Weight: 0.69kg
- Product Size: 138*138*100mm

4. Diagram of the LCD Display & the Buttons

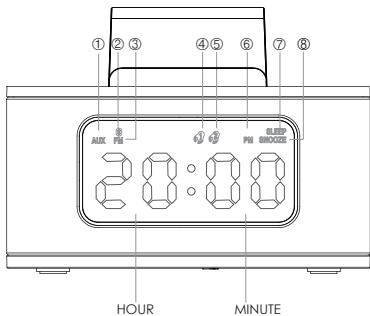

- ① AUX IN
- ② Bluetooth
- ③ FM
- ④ Alarm 1
- ⑤ Alarm 2
- ⑥ PM
- ⑦ SLEEP
- ⑧ SNOOZE

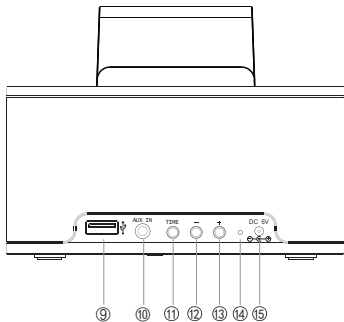

- ⑨ USB Jack
- ⑩ AUX IN Jack
- ⑪ Time Setting
- ⑫ Volume down
- ⑬ Volume up
- ⑭ FM Antenna
- ⑮ DC 5V Power Input

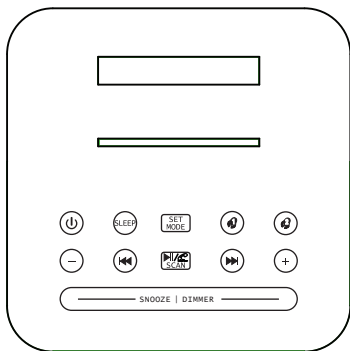

Button	Function
	Power ON/OFF
	SNOOZE 90-80-70-60-50-40-30-20-10-00 Minute
	Switch Modes; Alarm Time Setting
	Time Setting of Alarm 1
	Time Setting of Alarm 2
	Volume down/ Adjusting Alarm Time
	Skip Backwards last Song
	Bluetooth, Play/Pause, Answer the phone and Hang up/Auto Scan FM Station
	Skip Forwards next Song
	Volume up/ Adjusting Alarm Time
SNOOZE DIMMER	SNOOZE, Display Brightness Level (3Levels: 1-2-3)

5. Operating Instruction



5.1 Power ON

Connect the power adaptor into the jack on the back of S1 labeled “DC”, and then plug the power adaptor into the wall outlet. The LCD display turns on. Press  to turn on the unit.

5.2 Set Time

Under any mode, press “Time” to set time. Press “+” or “-” to switch the Hour mode between 12-Hour and 24-Hour. Press “Time” to confirm it. Then Hour figure and MINUTE figure begin to flash. Press “+” or “-” to adjust the HOUR and press “Time” to confirm it, then press “+” or “-” to adjust the MINUTE and press “Time” to confirm the setting. It exits the setting in 10seconds if no operation on any key.

5.3 Set Alarm Time

Under any mode, press  to enter alarm time setting,  icon displays in the LCD. Press  some times to display OFF/BU. (OFF- none alarm is selected). When BU icon appears, press “SET/MODE” to enter alarm time setting. The HOUR figure begins to flash, then press “+” or “-” on the top side of the unit to adjust the figure; Press “SET/MODE”, the MINUTE figure begins to flash. Press “+” or “-” to adjust the figure. It

will exit the setting in 5 seconds if no operation on any key.

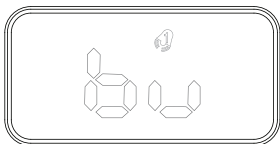

Alarm Ring Source - BUZZ

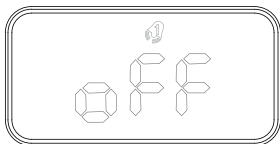





Alarm OFF

5.4 Alarm Function

1) When alarm1 is on,  icon is flashing in the LCD and the alarm ring tone is becoming larger and larger. Press "SNOOZE" to activate the Snooze function. SNOOZE icon appears in the LCD. Alarm will be on again in 9-minute snooze. The alarm can last for 30minutes at most if no button is pressed (including snooze time).

2) To stop alarm, press  or . Alarm 1 is one-off alarm.

3) Setting Alarm  is the same as setting Alarm . Alarm  works everyday. To turn it off completely, switch  to OFF mode.

6. SLEEP Function under ON Mode

Press "SLEEP" to set timing shutdown time from 90-80-70.....OFF.

Choose the time, it will store it automatically in 3 seconds and exit the setting. To see the remaining sleep time, press "SLEEP".

7. Play Music from Mobile via Bluetooth

7.1 Operation

Press “MODE” to choose Bluetooth mode. Go to mobile settings, turn on Bluetooth and search Bluetooth devices. Connect “ MUANGTHAI”. When it is successfully paired, you will hear a sound of “DU”. Play music from your mobile now. (When Bluetooth is connected, press “ Mode ” to switch it to other mode, Bluetooth will be OFF automatically and get disconnected with mobile. When switching it to Bluetooth mode again, connect “Smart one” manually or automatically.)

7.2 Answer the Phone

When a phone call is coming, press  to answer the phone.

7.3 Hang up

Press  to hang up when having a phone call.

7.4 Play Music

When playing music, press  to pause the music. Press  to skip backwards last song; Press  to skip forwards next song.

8. FM Radio Operation

Switch the unit to FM mode, Press and Hold **▶/⏪**/**⏩**/scan to auto scan radio station and store the scanned stations accordingly. The frequency starts from 87.5MHz to 108MHz and skips at every 0.1 MHz in scanning process. Once catching a station, it stops a second and store it, then continues the auto-scanning. When it scans from 87.5MHz to 108MHz or stores 20 stations, it will stop scan automatically. Press **⏪** or **▶** to select the station.

9. Play Music from Aux Jack

Press “MODE” to switch the mode to AUX IN, pug in the 3.5mm audio cable into the AUX IN jack. Play music now.

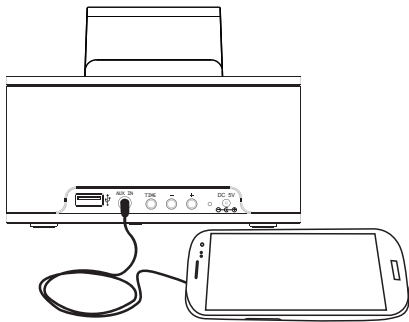

10. Back-up Button Battery

The 3V button battery is to retain the alarm/clock setting in case of a power failure. It can not display the alarm/clock time.

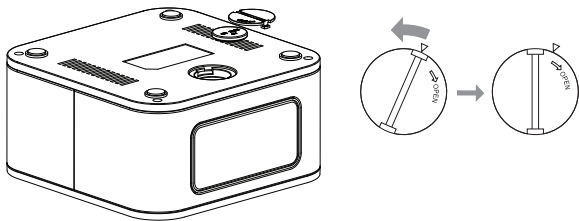

16页后三页为空白页 80G 书写纸 单黑 +骑马钉

料号： 311-S1BT0000-10