







**Mode No.:**

W0580M800L, C0203M300L, W0101M010L, W0102M020L, W0103M030L, W0105M050L, W0110M100L, W0120M200L, W0103M300L, W0106M600L, W0201M010L, W0202M020L, W0203M030L, W0205M050L, W0210M100L, W0220M200L, W0203M300L, W0206M600L, W0305M050L, W0310M100L, W0320M200L, W0330M300L, W0303M300L, W0306M600L, W0405M050L, W0410M100L, W0420M200L, W0430M300L, W0440M400L, W0450M500L, W0480M800L, W0403M300L, W0406M600L, W0505M050L, W0510M100L, W0520M200L, W0530M300L, W0550M500L, W0580M800L, C0101M010L, C0102M020L, C0103M030L, C0105M050L, C0110M100L, C0120M200L, C0103M300L, C0106M600L, C0201M010L, C0202M020L, C0203M030L, C0205M050L, C0210M100L, C0220M200L, C0203M300L, C0206M600L, C0305M050L, C0310M100L, C0320M200L, C0330M300L, C0303M300L, C0306M600L, C0405M050L, C0410M100L, C0420M200L, C0430M300L, C0440M400L, C0450M500L, C0480M800L, C0403M300L, C0406M600L, C0505M050L, C0510M100L, C0520M200L, C0530M300L, C0550M500L, C0580M800L

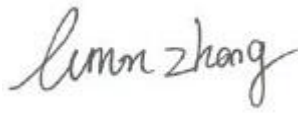

Revision Record			
Version	Description	Date	Remark
00	Original	2019-04-26	/

Authorized for issue by:			
			
		_____ Lemon Zhang / Project Engineer	
			
		_____ Bruce Tang / Reviewer	

## 2 Test Summary

Emission Part				
Item	Standard	Method	Requirement	Result
Conducted Emissions at Mains Terminals (9kHz-30MHz)	EN 55015:2013 +A1:2015	EN 55015:2013+A1:2015	N/A	Pass
Radiated Emissions (30MHz-300MHz)	EN 55015:2013 +A1:2015	CISPR 32:2015	N/A	Pass
Radiated Emissions (Magnetic field Induced Current)(9kHz-30MHz)	EN 55015:2013 +A1:2015	EN 55015:2013+A1:2015	N/A	Pass
Harmonic Current Emission	EN 61000-3-2:2014	EN 61000-3-2:2014	Class C	N/A*
Voltage Fluctuations and Flicker	EN 61000-3-3:2013	EN 61000-3-3:2013	Clause 5 of EN 61000-3-3	Pass

N/A: Not applicable

N/A\*: Not applicable, Please refer to Section 6.4 of this report for details.

Immunity Part				
Item	Standard	Method	Requirement	Result
Electrostatic Discharge	EN 61547:2009	EN 61000-4-2:2009	4kV Contact Discharge 8kV Air Discharge	Pass
Radiated Immunity (80MHz-1GHz)	EN 61547:2009	EN 61000-4-3:2006 +A1:2008+A2:2010	3V/m, 80%, 1kHz Amp. Mod.	Pass
Electrical Fast Transients/Burst at Power Port	EN 61547:2009	EN 61000-4-4:2012	1kV 5/50ns Tr/Td 5kHz Repetition Frequency	Pass
Surge at Power Port	EN 61547:2009	EN 61000-4-5:2014 +A1:2017	1.2/50µs Tr/Td 0.5kV Line to Line 1kV Line to Ground	Pass
Conducted Immunity at Power Port (150kHz-80MHz)	EN 61547:2009	EN 61000-4-6:2014	3Vrms (emf),80%,1kHz Amp. Mod.	Pass
Voltage Dips and Interruptions	EN 61547:2009	EN 61000-4-11:2004 +A1:2017	0 % UT for 0.5per 70 % UT for 10per UT is Supply Voltage	Pass

N/A: Not applicable

### Note1: Declaration of EUT Family Grouping:

There are series models mentioned in this report and they are the similar in electrical and electronic characters. Only the model W0580M800L was tested since their differences are model number and appearance

### 3 Contents

	Page
<b>1 COVER PAGE .....</b>	<b>1</b>
<b>2 TEST SUMMARY .....</b>	<b>4</b>
<b>3 CONTENTS .....</b>	<b>5</b>
<b>4 GENERAL INFORMATION .....</b>	<b>6</b>
4.1 DETAILS OF E.U.T. ....	6
4.2 DESCRIPTION OF SUPPORT UNITS.....	6
4.3 MEASUREMENT UNCERTAINTY .....	6
4.4 TEST LOCATION .....	7
4.5 TEST FACILITY .....	7
4.6 DEVIATION FROM STANDARDS .....	7
4.7 ABNORMALITIES FROM STANDARD CONDITIONS.....	7
4.8 MONITORING OF EUT FOR ALL IMMUNITY TEST .....	7
<b>5 EQUIPMENT LIST .....</b>	<b>8</b>
<b>6 EMISSION TEST RESULTS.....</b>	<b>10</b>
6.1 CONDUCTED EMISSIONS AT MAINS TERMINALS (9KHZ-30MHZ) .....	10
6.2 RADIATED EMISSIONS (30MHZ-300MHZ) .....	13
6.3 RADIATED EMISSIONS (MAGNETIC FIELD INDUCED CURRENT)(9KHZ-30MHZ) .....	16
6.4 HARMONIC CURRENT EMISSION.....	20
6.5 VOLTAGE FLUCTUATIONS AND FLICKER.....	21
<b>7 IMMUNITY TEST RESULTS.....</b>	<b>22</b>
7.1 PERFORMANCE CRITERIA DESCRIPTION IN EN 61547:2009 .....	22
7.2 ELECTROSTATIC DISCHARGE .....	23
7.3 RADIATED IMMUNITY (80MHZ-1GHZ) .....	24
7.4 ELECTRICAL FAST TRANSIENTS/BURST AT POWER PORT .....	25
7.5 SURGE AT POWER PORT .....	26
7.6 CONDUCTED IMMUNITY AT POWER PORT (150KHZ-80MHZ) .....	27
7.7 VOLTAGE DIPS AND INTERRUPTIONS .....	28
<b>8 PHOTOGRAPHS .....</b>	<b>29</b>
8.1 CONDUCTED EMISSIONS AT MAINS TERMINALS (9KHZ-30MHZ) TEST SETUP .....	29
8.2 RADIATED EMISSIONS (30MHZ-300MHZ) TEST SETUP .....	29
8.3 RADIATED EMISSIONS (MAGNETIC FIELD INDUCED CURRENT)(9KHZ-30MHZ) TEST SETUP.....	30
8.4 VOLTAGE FLUCTUATIONS AND FLICKER TEST SETUP .....	30
8.5 ELECTROSTATIC DISCHARGE TEST SETUP .....	31
8.6 RADIATED IMMUNITY (80MHZ-1GHZ) TEST SETUP.....	31
8.7 ELECTRICAL FAST TRANSIENTS/BURST AT POWER PORT TEST SETUP .....	32
8.8 SURGE AT POWER PORT TEST SETUP .....	32
8.9 CONDUCTED IMMUNITY AT POWER PORT (150KHZ-80MHZ) TEST SETUP.....	33
8.10 VOLTAGE DIPS AND INTERRUPTIONS TEST SETUP.....	33
8.11 EUT CONSTRUCTIONAL DETAILS (EUT PHOTOS) .....	34-39

## 4 General Information

### 4.1 Details of E.U.T.

Power supply: For Light: DC 5V 1A  
 For remote: DC 3V (1\*3V "CR2025" Button Cell)

Test voltage: AC 230V 50Hz

### 4.2 Description of Support Units

Description	Manufacturer	Model No.	Serial No.
adapter (supplied by SGS)	-	-	-

### 4.3 Measurement Uncertainty

No.	Item	Measurement Uncertainty
1	Conducted Emission at mains port using AMN	±2.6dB (9kHz to 150kHz)
		±2.3dB (150kHz to 30MHz)
2	Conducted Emission at mains port using VP	±1.9 dB (9kHz to 30MHz)
3	Conducted Emission at telecommunication port using AAN	±4.1 dB (150kHz to 30MHz)
4	Radiated Power	±3.0dB
5	Radiated emission	±4.4dB (30MHz-1GHz)
		±4.8dB (1GHz-6GHz)
		±5.2dB (6GHz-18GHz)

Note: The measurement uncertainty represents an expanded uncertainty expressed at approximately the 95% confidence level using a coverage factor of k=2.

#### 4.4 Test Location

All tests were performed at:

SGS-CSTC Standards Technical Services (Shanghai) Co., Ltd. E&E Lab

588 West Jindu Road, Xinqiao, Songjiang, 201612 Shanghai, China

Tel: +86 21 6191 5666

Fax: +86 21 6191 5678

No tests were sub-contracted.

#### 4.5 Test Facility

The test facility is recognized, certified, or accredited by the following organizations:

- **CNAS (No. CNAS L0599)**

CNAS has accredited SGS-CSTC Standards Technical Services (Shanghai) Co., Ltd. to ISO/IEC 17025:2005 General Requirements for the Competence of Testing and Calibration Laboratories (CNAS-CL01 Accreditation Criteria for the Competence of Testing and Calibration Laboratories) for the competence in the field of testing.

- **NVLAP (Certificate No. 201034-0)**

SGS-CSTC Standards Technical Services (Shanghai) Co., Ltd. is accredited by the National Voluntary Laboratory Accreditation Program (NVLAP). Certificate No. 201034-0.

- **FCC –Designation Number: CN5033**

SGS-CSTC Standards Technical Services (Shanghai) Co., Ltd. has been recognized as an accredited testing laboratory.

Designation Number: CN5033. Test Firm Registration Number: 479755.

- **Innovation, Science and Economic Development Canada**

SGS-CSTC Standards Technical Services (Shanghai) Co., Ltd. EMC Laboratory has been recognized by ISED as an accredited testing laboratory.

IC Registration No.: 8617A-1. CAB identifier: CN0020.

- **VCCI (Member No.: 3061)**

The 3m Semi-anechoic chamber and Shielded Room of SGS-CSTC Standards Technical Services (Shanghai) Co., Ltd. has been registered in accordance with the Regulations for Voluntary Control Measures with Registration No.: R-13868, C-14336, T-12221, G-10830 respectively.

#### 4.6 Deviation from Standards

None

#### 4.7 Abnormalities from Standard Conditions

None

#### 4.8 Monitoring of EUT for All Immunity Test

Visual: Monitor the lamp lighting.

## 5 Equipment List

<b>Conducted Emissions at Mains Terminals (9kHz-30MHz)</b>					
<b>Equipment</b>	<b>Manufacturer</b>	<b>Model No</b>	<b>Inventory No</b>	<b>Cal Date</b>	<b>Cal Due Date</b>
EMI test receiver	Rohde & Schwarz	ESR7	SHEM162-1	2018-12-20	2019-12-19
Line impedance stabilization network	SCHWARZBECK	NSLK8127	SHEM061-1	2018-12-20	2019-12-19
Line impedance stabilization network	EMCO	3816/2	SHEM019-1	2018-12-20	2019-12-19
Pulse limiter	Rohde & Schwarz	ESH3-Z2	SHEM029-1	2018-12-20	2019-12-19
Shielding Room	ZHONGYU	8*4*3M	SHEM079-2	2017-12-20	2020-12-19
CE test Cable	/	/	CE01	2018-12-26	2019-12-25

<b>Radiated Emissions (30MHz-300MHz)</b>					
<b>Equipment</b>	<b>Manufacturer</b>	<b>Model No</b>	<b>Inventory No</b>	<b>Cal Date</b>	<b>Cal Due Date</b>
EMI test receiver	Rohde & Schwarz	ESU40	SHEM051-1	2018-12-20	2019-12-19
CONTROLLER	INNCO	CO200	SHEM047-1	N/A	N/A
ANTENNA MAST	INNCO	MA400-EP	SHEM047-2	N/A	N/A
TURN DEVICE	INNCO	DE 3600-RH	SHEM047-3	N/A	N/A
Broadband UHF-VHF ANTENNA	SCHWARZBECK	VULB9168	SHEM048-1	2017-02-28	2020-02-27
Semi/Fully Anechoic	ST	11*6*6M	SHEM078-2	2017-07-22	2020-07-21
Low Amplifier	CLAVIIO	BDLNA-0001-412010	SHEM164-1	2018-08-13	2019-08-12

<b>Radiated Emissions (Magnetic field Induced Current)(9kHz-30MHz)</b>					
<b>Equipment</b>	<b>Manufacturer</b>	<b>Model No</b>	<b>Inventory No</b>	<b>Cal Date</b>	<b>Cal Due Date</b>
EMI test receiver	Rohde & Schwarz	ESR7	SHEM162-1	2018-12-20	2019-12-19
3-dimensional large loop antenna,diam.2m.acc	Rohde & Schwarz	HXYZ9170	SHEM017-1	2018-12-20	2019-12-19
Pulse limiter	Rohde & Schwarz	ESH3-Z2	SHEM029-1	2018-12-20	2019-12-19
Shielding Room	ZHONGYU	8*4*3M	SHEM079-2	2017-12-20	2020-12-19
CE test Cable	/	/	CE01	2018-12-26	2019-12-25

<b>Voltage Fluctuations and Flicker</b>					
<b>Equipment</b>	<b>Manufacturer</b>	<b>Model No</b>	<b>Inventory No</b>	<b>Cal Date</b>	<b>Cal Due Date</b>
Harmonic&Flicker analyzer	AMETEK	PACS-1	SHEM024-2	2018-08-13	2019-08-12
AC Power Source 5KVA	AMETEK	5001iX	SHEM025-2	2018-08-13	2019-08-12

<b>Electrostatic Discharge</b>					
<b>Equipment</b>	<b>Manufacturer</b>	<b>Model No</b>	<b>Inventory No</b>	<b>Cal Date</b>	<b>Cal Due Date</b>
Electrostatic Discharge Simulator	TESEQ	NSG 437	SHEM041-2	2018-08-13	2019-08-12

<b>Radiated Immunity (80MHz-1GHz)</b>					
<b>Equipment</b>	<b>Manufacturer</b>	<b>Model No</b>	<b>Inventory No</b>	<b>Cal Date</b>	<b>Cal Due Date</b>
Signal generator	Rohde & Schwarz	SMJ100A	SHEM141-1	2018-08-13	2019-08-12
Power Meter	Rohde & Schwarz	NRP	SHEM057-1	2018-12-20	2019-12-19



Power meter sensor	Rohde & Schwarz	NRP-Z91	SHEM057-2	2018-12-20	2019-12-19
Antenna	SCHWARZBECK	STLP9128D	SHEM130-1	N/A	N/A
Amplifier	MILMEGA	AS0840-55-55	SHEM133-1	2018-12-20	2019-12-19
Power meter sensor	Rohde & Schwarz	NRP-Z22	SHEM136-1	2018-12-20	2019-12-19
ElectroMagnetic Field Probe	ETS-Lindgren	HI-6105	SHEM134-1	2018-12-11	2019-12-10
Semi/Fully Anechoic	ST	11*6*6M	SHEM078-2	2017-07-22	2020-07-21

**Electrical Fast Transients/Burst at Power Port**

Equipment	Manufacturer	Model No	Inventory No	Cal Date	Cal Due Date
Immunity Test System	EMC PARTNER	TRA3000 F-S-D-V	SHEM163-1	2018-12-20	2019-12-19

**Surge at Power Port**

Equipment	Manufacturer	Model No	Inventory No	Cal Date	Cal Due Date
Immunity Test System	EMC PARTNER	TRA3000 F-S-D-V	SHEM163-1	2018-12-20	2019-12-19

**Conducted Immunity at Power Port (150kHz-80MHz)**

Equipment	Manufacturer	Model No	Inventory No	Cal Date	Cal Due Date
Signal generator	Rohde & Schwarz	SMJ100A	SHEM141-1	2018-08-13	2019-08-12
PAMP Conducted RF test system	HAEFFLY	PAMP250	SHEM023-1	2018-12-20	2019-12-19
6dB Attenuator	HUAXIANG	DTS50-6dB-1G-A	SHEM123-2	2018-12-20	2019-12-19
Coupling clamp	LIITHI	EM 101	SHEM027-1	2018-12-20	2019-12-19
CDN impedance and K-factor	LUTHI	L-801 M1	SHEM023-5	2018-12-20	2019-12-19
CDN impedance and K-factor	LUTHI	L-801 M2/M3	SHEM023-6	2018-12-20	2019-12-19
Shielding Room	ZHONGYU	5*5*3M	SHEM079-6	2016-12-29	2019-12-28
Coupling and Decoupling Network	Teseq	CDN M016	SHEM168-1	2018-08-13	2019-08-12

**Voltage Dips and Interruptions**

Equipment	Manufacturer	Model No	Inventory No	Cal Date	Cal Due Date
Immunity Test System	EMC PARTNER	TRA3000 F-S-D-V	SHEM163-1	2018-12-20	2019-12-19

**General used equipment**

Equipment	Manufacturer	Model No	Inventory No	Cal Date	Cal Due Date
Digital pressure meter	YONGZHI	DYM3-01	SHEM082-1	2018-01-25	2021-01-24
Temperature&humidity recorder	ShangHai weather meter work	ZJ 1-2B	SHEM042-1~6	2018-08-31	2019-08-30
Digital Multimeter	FLUKE	17B	SHEM043-3	2018-09-03	2019-09-02
Autoformer regulator	Guangzhou bao de	TDGC2-5KVA	SHEM150-1	N/A	N/A
Multi-purpose tong tester	FLUKE	316	SHEM001-1	2018-12-20	2019-12-19

## 6 Emission Test Results

### 6.1 Conducted Emissions at Mains Terminals (9kHz-30MHz)

Test Requirement:	EN 55015:2013 +A1:2015
Test Method:	EN 55015:2013+A1:2015
Frequency Range:	9kHz to 30MHz
Limit:	
0.009MHz – 0.05MHz	110dB(μV) quasi-peak
0.05MHz – 0.15MHz	90dB(μV)-80dB(μV) quasi-peak
0.15MHz – 0.5MHz	66dB(μV)-56dB(μV) quasi-peak, 56dB(μV)-46dB(μV) average
0.5MHz – 5MHz	56dB(μV) quasi-peak, 46dB(μV) average
5MHz – 30MHz	60dB(μV) quasi-peak, 50dB(μV) average
Detector:	Peak for pre-scan (200Hz resolution bandwidth) 0.009M to 0.15MHz Peak for pre-scan (9kHz resolution bandwidth) 0.15M to 30MHz

#### 6.1.1 E.U.T. Operation

Operating Environment:

Temperature: 22 °C      Humidity: 50 % RH      Atmospheric Pressure: 1002 mbar

Test mode      a: Lighting Mode: Keep the lamp lighting continuously.

#### 6.1.2 Test Setup Diagram

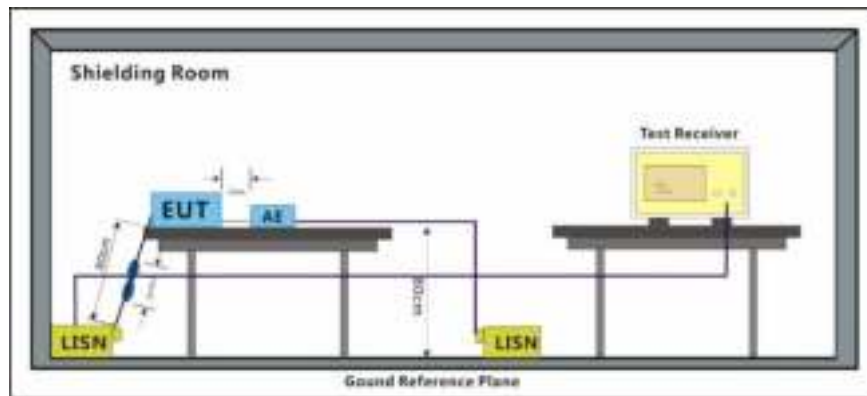

#### 6.1.3 Measurement Data

An initial pre-scan was performed with peak detector. Quasi-Peak or Average measurement were performed at the frequencies with maximized peak emission were detected.

Mode:a; Line:Live Line

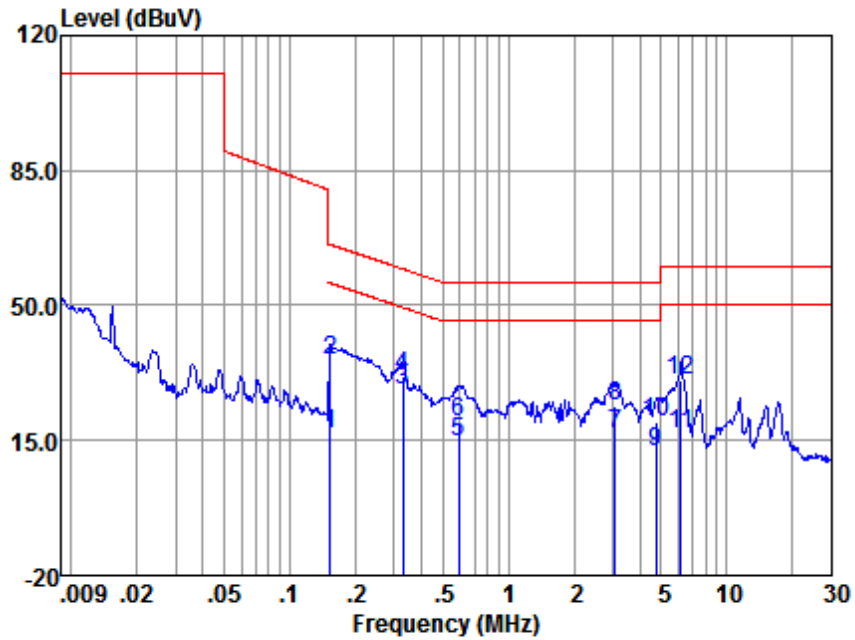

LISN : LINE  
EUT/Project No : 11612LM  
Test mode : a

	Freq (MHz)	Read level (dBuV)	LISN Factor (dB)	Cable Loss (dB)	Emission Level (dBuV)	Limit (dBuV)	Over Limit (dB)	Remark
1	0.15	6.86	0.05	10.00	16.91	55.87	-38.96	Average
2	0.15	25.68	0.05	10.00	35.73	65.87	-30.14	QP
3	0.33	17.82	0.05	10.00	27.87	49.46	-21.59	Average
4	0.33	21.67	0.05	10.00	31.72	59.46	-27.74	QP
5	0.60	4.54	0.04	10.00	14.58	46.00	-31.42	Average
6	0.60	9.60	0.04	10.00	19.64	56.00	-36.36	QP
7	3.09	6.43	0.06	10.20	16.69	46.00	-29.31	Average
8	3.09	13.63	0.06	10.20	23.89	56.00	-32.11	QP
9	4.75	1.43	0.08	10.30	11.81	46.00	-34.19	Average
10	4.75	9.37	0.08	10.30	19.75	56.00	-36.25	QP
11	6.18	6.22	0.10	10.30	16.62	50.00	-33.38	Average
12	6.18	20.32	0.10	10.30	30.72	60.00	-29.28	QP

Notes: Emission Level = Read Level + LISN Factor + Cable loss

Mode:a; Line:Neutral Line

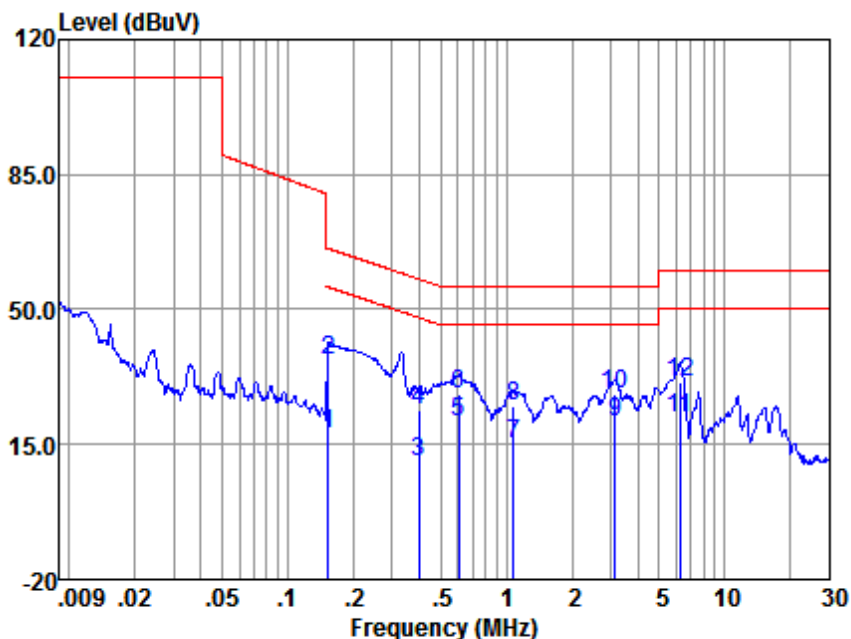

LISN : NEUTRAL  
 EUT/Project No : 11612LM  
 Test mode : a

Freq (MHz)	Read level (dBuV)	LISN Factor (dB)	Cable Loss (dB)	Emission Level (dBuV)	Limit (dBuV)	Over Limit (dB)	Remark	
1	0.15	7.89	0.06	10.00	17.95	55.87	-37.92	Average
2	0.15	26.76	0.06	10.00	36.82	65.87	-29.05	QP
3	0.40	0.33	0.05	10.00	10.38	47.92	-37.54	Average
4	0.40	13.64	0.05	10.00	23.69	57.92	-34.23	QP
5	0.61	10.85	0.05	10.00	20.90	46.00	-25.10	Average
6	0.61	18.24	0.05	10.00	28.29	56.00	-27.71	QP
7	1.08	5.03	0.05	10.08	15.16	46.00	-30.84	Average
8	1.08	14.72	0.05	10.08	24.85	56.00	-31.15	QP
9	3.15	10.43	0.07	10.25	20.75	46.00	-25.25	Average
10	3.15	17.61	0.07	10.25	27.93	56.00	-28.07	QP
11	6.23	11.57	0.11	10.30	21.98	50.00	-28.02	Average
12	6.23	20.70	0.11	10.30	31.11	60.00	-28.89	QP

Notes: Emission Level = Read Level + LISN Factor + Cable loss

## 6.2 Radiated Emissions (30MHz-300MHz)

Test Requirement:	EN 55015:2013 +A1:2015
Test Method:	CISPR 32:2015
Frequency Range:	30MHz to 300MHz
Measurement Distance:	3m
Limit:	
30MHz-230MHz	40dB(μV/m) quasi-peak
230MHz-300MHz	47dB(μV/m) quasi-peak
Detector:	Peak for pre-scan (120kHz resolution bandwidth) 30M to 300MHz

### 6.2.1 E.U.T. Operation

Operating Environment:

Temperature: 22 °C Humidity: 50 % RH Atmospheric Pressure: 1020 mbar

Test mode a: Lighting Mode: Keep the lamp lighting continuously.

### 6.2.2 Test Setup Diagram

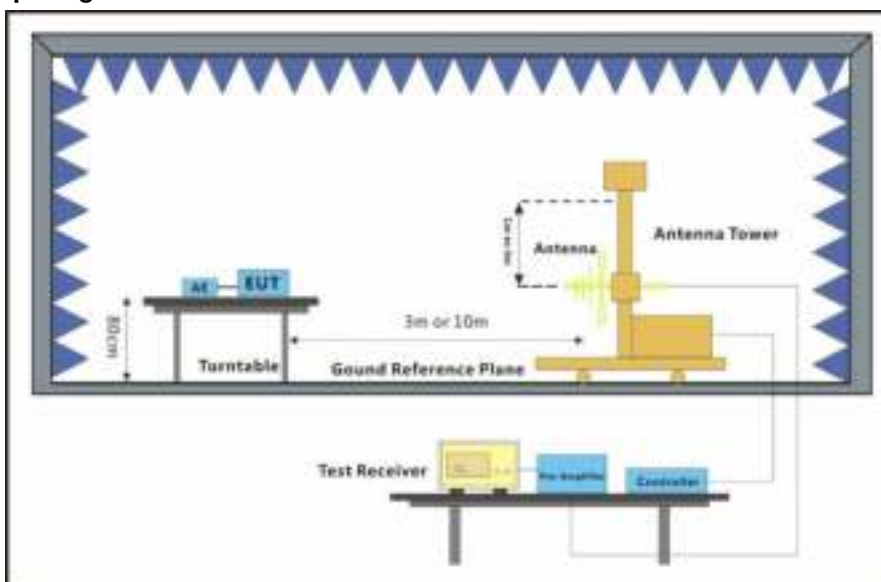

### 6.2.3 Measurement Data

An initial pre-scan was performed in the chamber using the spectrum analyser in peak detection mode. Quasi-peak measurements were conducted based on the peak sweep graph. The EUT was measured by BiConiLog antenna with 2 orthogonal polarities.

Mode:a; Polarization:Horizontal

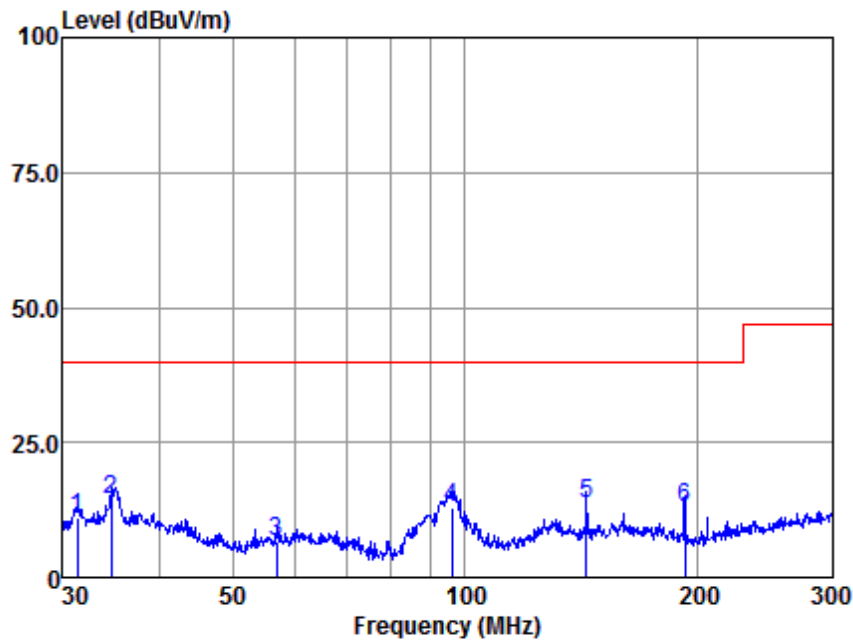

Antenna Polarity :HORIZONTAL  
EUT/Project :11612LM  
Test mode :a

	Freq	Read Level	Antenna Factor	Cable Loss	Preamp Factor	Emission Level	Limit Line	Over Limit	Remark
	MHz	dBuv	dB/m	dB	dB	dBuv/m	dBuv/m	dB	
1	31.34	37.85	15.45	0.28	42.37	11.21	40.00	-28.79	QP
2	34.68	40.72	15.82	0.37	42.35	14.56	40.00	-25.44	QP
3	56.90	36.42	12.00	0.56	42.33	6.65	40.00	-33.35	QP
4	96.19	45.16	8.99	1.08	42.31	12.92	40.00	-27.08	QP
5	143.92	43.12	11.51	1.37	42.24	13.76	40.00	-26.24	QP
6	193.25	43.51	10.05	1.71	42.18	13.09	40.00	-26.91	QP

Note:Emission Level=Read Level+Antenna Factor+Cable loss-Preamp Factor

Mode:a; Polarization:Vertical

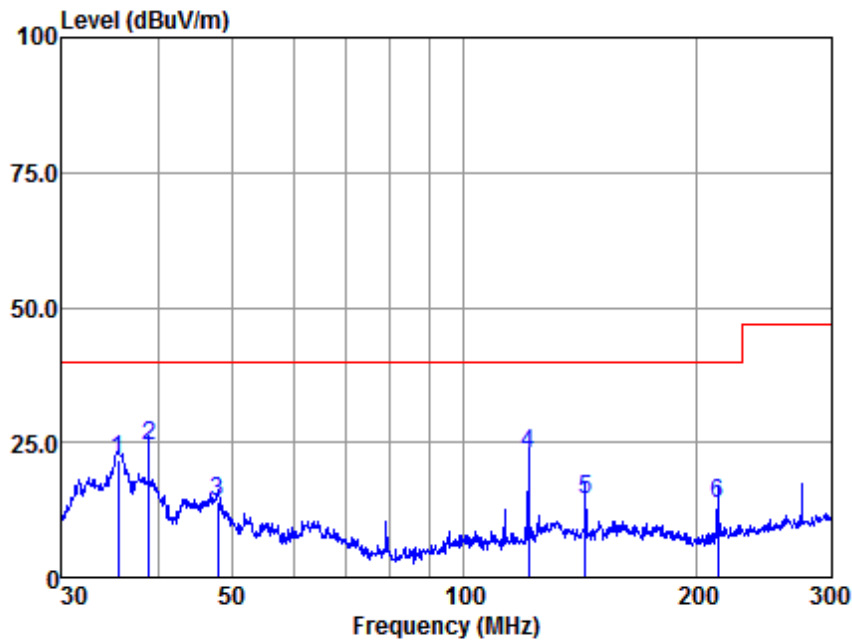

Antenna Polarity :VERTICAL  
EUT/Project :11612LM  
Test mode :a

	Freq	Read Level	Antenna Factor	Cable Loss	Preamp Factor	Emission Level	Limit Line	Over Limit	Remark
	MHz	dBuv	dB/m	dB	dB	dBuv/m	dBuv/m	dB	
1	35.49	47.70	15.88	0.41	42.35	21.64	40.00	-18.36	QP
2	38.92	50.16	16.22	0.13	42.33	24.18	40.00	-15.82	QP
3	47.88	44.30	11.76	0.44	42.33	14.17	40.00	-25.83	QP
4	121.37	53.47	10.33	1.33	42.28	22.85	40.00	-17.15	QP
5	143.92	43.84	11.51	1.37	42.24	14.48	40.00	-25.52	QP
6	213.86	43.76	10.05	1.86	42.16	13.51	40.00	-26.49	QP

Note:Emission Level=Read Level+Antenna Factor+Cable loss-Preamp Factor



### 6.3 Radiated Emissions (Magnetic field Induced Current)(9kHz-30MHz)

Test Requirement:	EN 55015:2013 +A1:2015
Test Method:	EN 55015:2013+A1:2015
Frequency Range:	9kHz to 30MHz
Limit:	
0.009MHz-0.07MHz	88dB(μA) quasi-peak
0.07MHz-0.15MHz	88dB(μA)-58dB(μA) quasi-peak
0.15MHz-3MHz	58dB(μA)-22dB(μA) quasi-peak
3MHz-30MHz	22dB(μA) quasi-peak
Detector:	Peak for pre-scan (200Hz resolution bandwidth) 0.009M to 0.15MHz Peak for pre-scan (9kHz resolution bandwidth) 0.15M to 30MHz

#### 6.3.1 E.U.T. Operation

Operating Environment:  
 Temperature: 22 °C      Humidity: 50 % RH      Atmospheric Pressure: 1002 mbar  
 Test mode      a: Lighting Mode: Keep the lamp lighting continuously.

#### 6.3.2 Test Setup Diagram

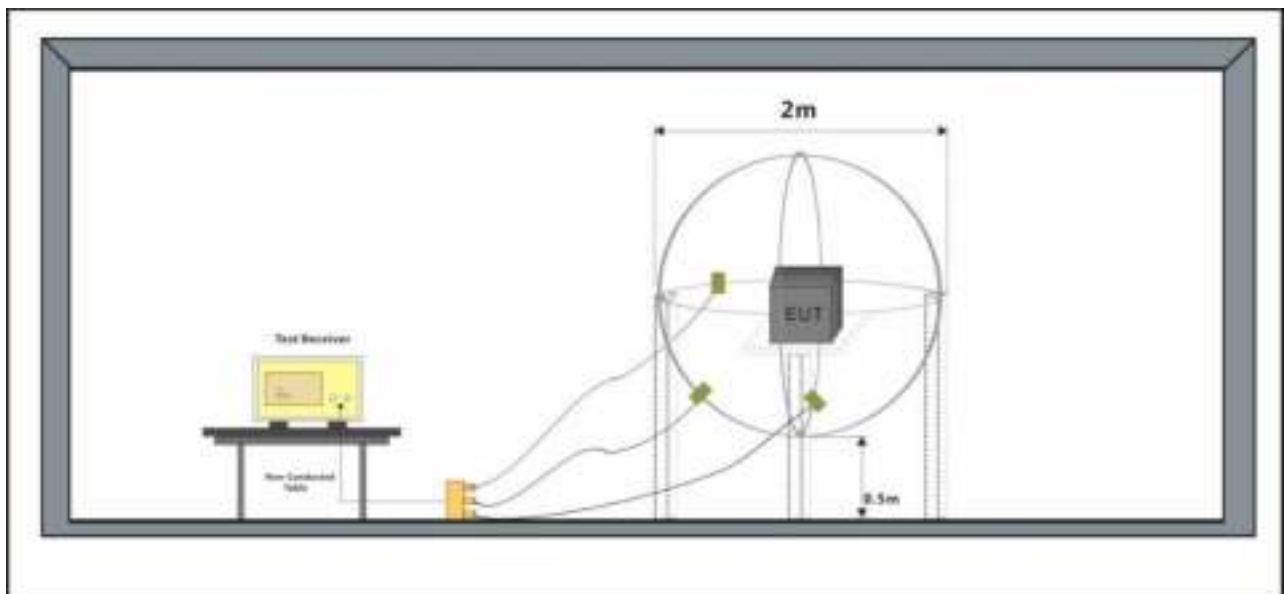

#### 6.3.3 Measurement Data

An initial pre-scan was performed in the 2m loop antenna using the spectrum analyser in peak detection mode. The EUT was measured for X(A), Y(B), Z(C) polarities.



Mode:a; Axial:X

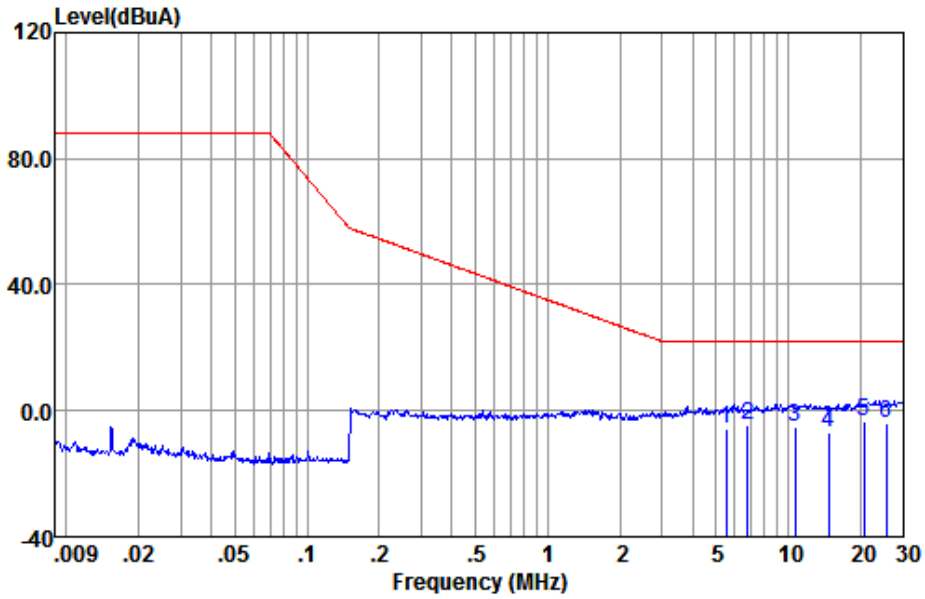

EUT/Project No : 11612LM

Test Mode : a  
: X

	Freq (MHz)	Read level (dBuA)	Cable Loss (dB)	Emission Level (dBuA)	Limit (dBuA)	Over Limit (dB)	Remark
1	5.55	-5.98	0.21	-5.77	22.00	-27.77	QP
2	6.80	-5.00	0.24	-4.76	22.00	-26.76	QP
3	10.71	-5.55	0.34	-5.21	22.00	-27.21	QP
4	14.81	-7.18	0.38	-6.80	22.00	-28.80	QP
5	20.66	-3.88	0.49	-3.39	22.00	-25.39	QP
6	25.72	-4.52	0.60	-3.92	22.00	-25.92	QP

Notes: Emission Level = Read Level + Cable loss

Mode:a; Axial:Y

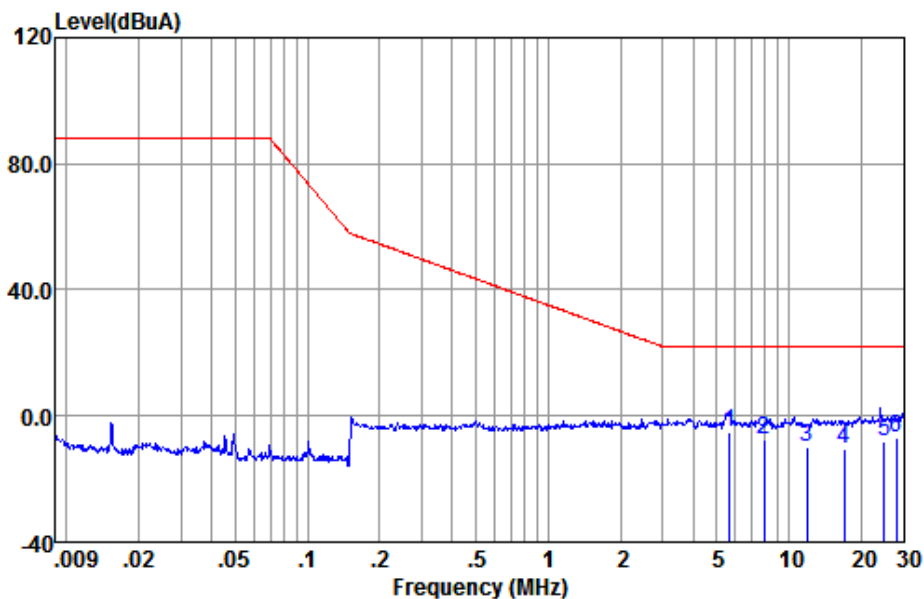

EUT/Project No : 11612LM

Test Mode : a

: Y

	Freq (MHz)	Read level (dBuA)	Cable Loss (dB)	Emission Level (dBuA)	Limit (dBuA)	Over Limit (dB)	Remark
1	5.69	-5.65	0.22	-5.43	22.00	-27.43	QP
2	7.93	-7.61	0.23	-7.38	22.00	-29.38	QP
3	11.90	-10.31	0.37	-9.94	22.00	-31.94	QP
4	17.00	-11.09	0.50	-10.59	22.00	-32.59	QP
5	24.89	-8.46	0.49	-7.97	22.00	-29.97	QP
6	28.12	-7.61	0.53	-7.08	22.00	-29.08	QP

Notes: Emission Level = Read Level + Cable loss

Mode:a; Axial:Z

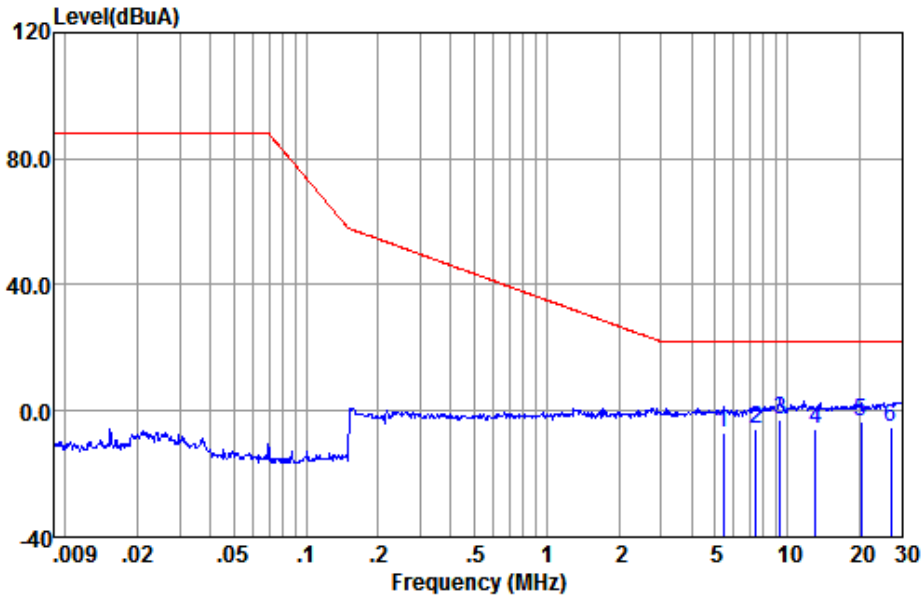

EUT/Project No : 11612LM

Test Mode : a  
: Z

	Freq (MHz)	Read level (dBuA)	Cable Loss (dB)	Emission Level (dBuA)	Limit (dBuA)	Over Limit (dB)	Remark
1	5.42	-7.24	0.21	-7.03	22.00	-29.03	QP
2	7.43	-5.78	0.24	-5.54	22.00	-27.54	QP
3	9.40	-3.37	0.31	-3.06	22.00	-25.06	QP
4	13.12	-6.36	0.37	-5.99	22.00	-27.99	QP
5	20.32	-4.17	0.50	-3.67	22.00	-25.67	QP
6	27.00	-5.71	0.59	-5.12	22.00	-27.12	QP

Notes: Emission Level = Read Level + Cable loss



## 6.4 Harmonic Current Emission

Test Requirement: EN 61000-3-2:2014

Test Method: EN 61000-3-2:2014

Frequency Range: 100Hz to 2kHz

### 6.4.1 Measurement Data

There is no need for Harmonics test to be performed on this LED lighting with rated power less than 25W since it is not the discharge lighting (active input power  $\leq 25W$ ) in accordance with EN 61000-3-2.

### 6.5 Voltage Fluctuations and Flicker

Test Requirement: EN 61000-3-3:2013  
Test Method: EN 61000-3-3:2013

#### 6.5.1 E.U.T. Operation

Operating Environment:  
Temperature: 22 °C Humidity: 50 % RH Atmospheric Pressure: 1020 mbar  
Test mode a: Lighting Mode: Keep the lamp lighting continuously.

#### 6.5.2 Test Setup Diagram

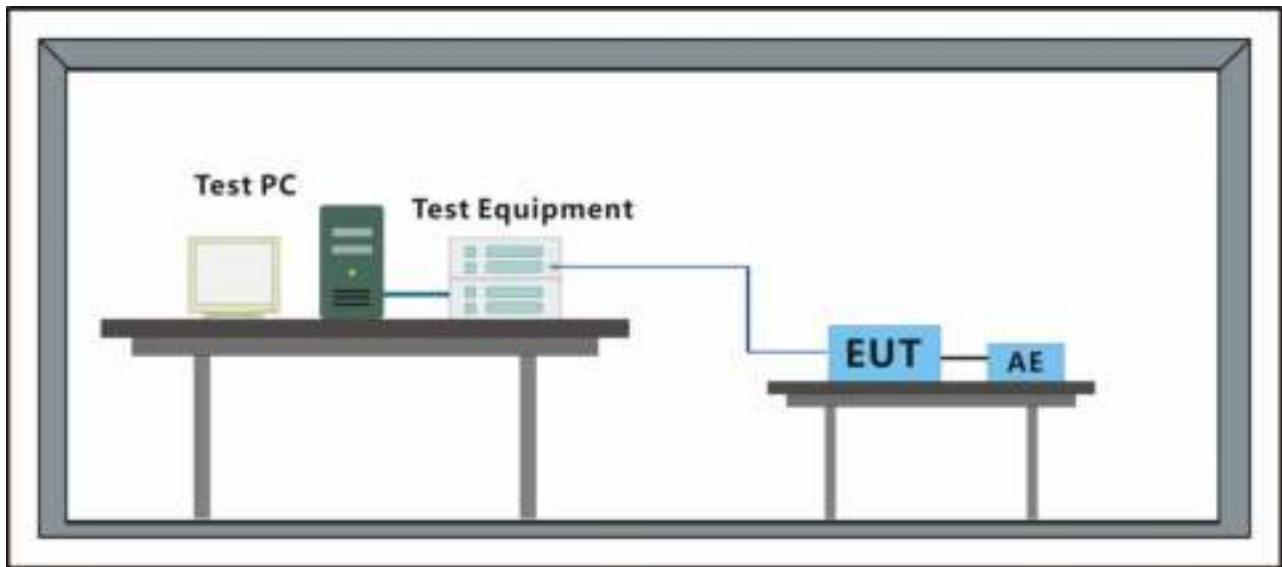

#### 6.5.3 Measurement Data

Mode:a

Parameter values recorded during the test:

Vrms at the end of test (Volt):	229.93			
T-max (mS):	0	Test limit (mS):	500.0	Pass
Highest dc (%):	0.00	Test limit (%):	3.30	Pass
Highest dmax (%):	0.00	Test limit (%):	4.00	Pass

## 7 Immunity Test Results

### 7.1 Performance Criteria Description in EN 61547:2009

- Criterion A** During the test no change of the luminous intensity shall be observed and the regulating control, if any, shall operate during the test as intended.
- Criterion B** During the test the luminous intensity may change to any value. After the test the luminous intensity shall be restored to its initial value within 1 min.  
Regulating controls need not function during the test, but after the test the mode of the control shall be the same as before the test provided that during the test no mode changing commands were given.
- Criterion C** During and after the test any change of the luminous intensity is allowed and the lamp(s) may be extinguished. After the test, within 30 min, all functions shall return to normal if necessary by temporary interruption of the mains supply and/or operating the regulating control.

## 7.2 Electrostatic Discharge

Test Requirement: EN 61547:2009  
 Test Method: EN 61000-4-2:2009  
 Performance Criterion: B  
 Discharge Impedance: 330Ω/150pF  
 Number of Discharge: Minimum 10 times at each test point  
 Discharge Mode: Single Discharge  
 Discharge Period: 1 second minimum

### 7.2.1 Test Setup Diagram

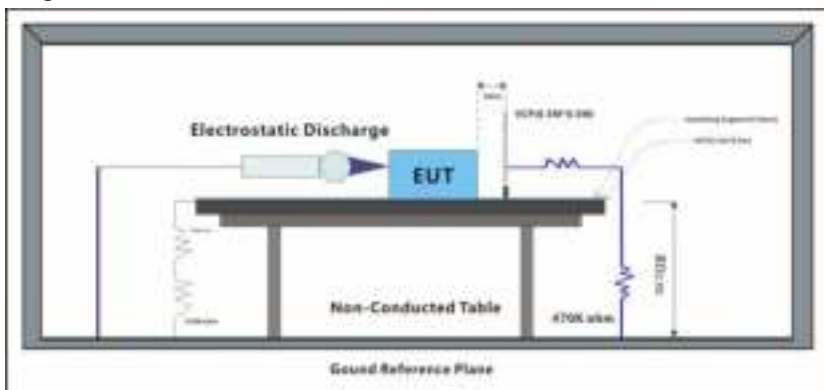

### 7.2.2 E.U.T. Operation

Operating Environment:  
 Temperature: 22 °C Humidity: 50 % RH Atmospheric Pressure: 1020 mbar  
 Test mode: a: Lighting Mode: Keep the lamp lighting continuously.

### 7.2.3 Test Results:

Observations: Test Point:  
 1. All insulated enclosure and seams.  
 2. All accessible metal parts of the enclosure.  
 3. All side

Discharge type	Level (kV)	Polarity	Test Point	Result / Observations
Air Discharge	2,4,8	+	1	A
Air Discharge	2,4,8	-	1	A
Contact Discharge	4	+	2	A
Contact Discharge	4	-	2	A
Horizontal Coupling	4	+	3	A
Horizontal Coupling	4	-	3	A
Vertical Coupling	4	+	3	A
Vertical Coupling	4	-	3	A

### Results:

A: No degradation in the performance of the EUT was observed.

### 7.3 Radiated Immunity (80MHz-1GHz)

Test Requirement: EN 61547:2009  
 Test Method: EN 61000-4-3:2006 +A1:2008+A2:2010  
 Performance Criterion: A  
 Frequency Range: 80MHz to 1GHz  
 Antenna Polarisation: Vertical and Horizontal  
 Modulation: 1kHz,80% Amp. Mod,1% increment

#### 7.3.1 Test Setup Diagram

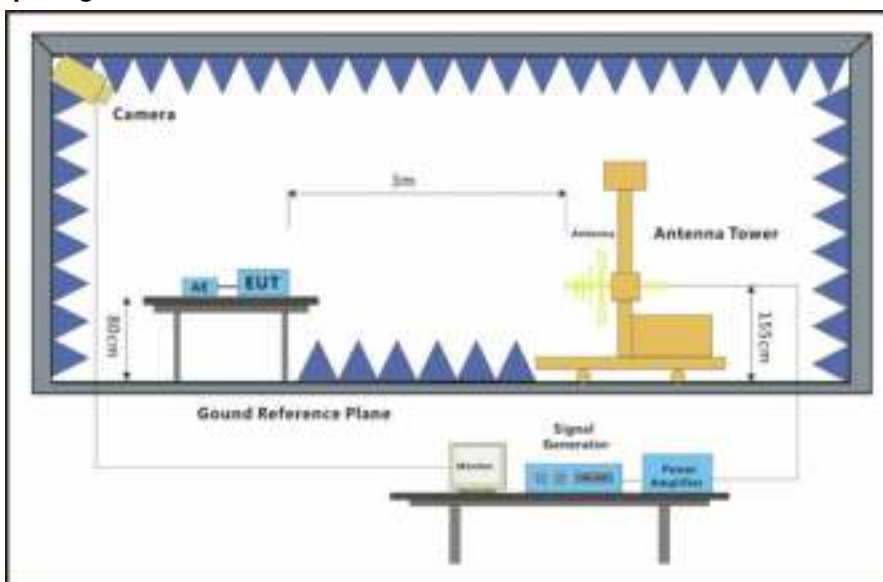

#### 7.3.2 E.U.T. Operation

Operating Environment:

Temperature: 22 °C Humidity: 50 % RH Atmospheric Pressure: 1020 mbar

Test mode: a: Lighting Mode: Keep the lamp lighting continuously.

#### 7.3.3 Test Results:

Frequency	Level (V/m)	EUT Face	Dwell time	Result / Observations
80MHz-1GHz	3	Front	2s	A
80MHz-1GHz	3	Back	2s	A
80MHz-1GHz	3	Left	2s	A
80MHz-1GHz	3	Right	2s	A
80MHz-1GHz	3	Top	2s	A
80MHz-1GHz	3	Underside	2s	A

#### Results:

A: No degradation in the performance of the EUT was observed.



### 7.4 Electrical Fast Transients/Burst at Power Port

Test Requirement: EN 61547:2009  
 Test Method: EN 61000-4-4:2012  
 Performance Criterion: B  
 Repetition Frequency: 5kHz  
 Burst Period: 300ms  
 Test Duration: 2 minute per level & polarity

#### 7.4.1 Test Setup Diagram

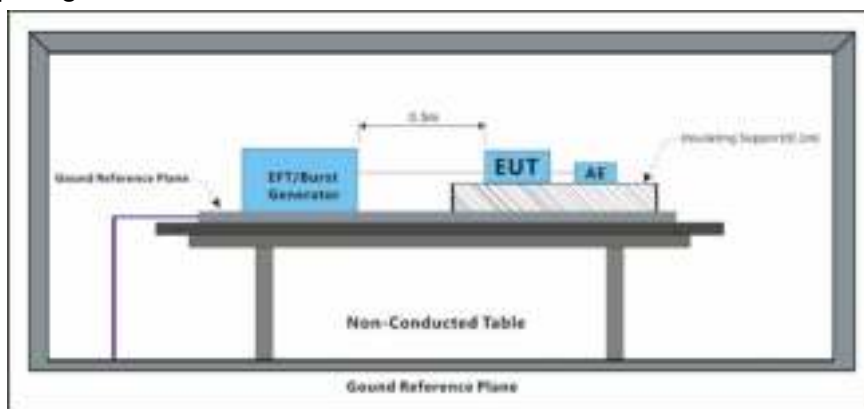

#### 7.4.2 E.U.T. Operation

Operating Environment:  
 Temperature: 22 °C      Humidity: 50 % RH      Atmospheric Pressure: 1020 mbar  
 Test mode: a: Lighting Mode: Keep the lamp lighting continuously.

#### 7.4.3 Test Results:

Test Line	Level (kV)	Polarity	CDN/Clamp	Result / Observations
AC power port	1	+	CDN	A
AC power port	1	-	CDN	A

#### Results:

A: No degradation in the performance of the EUT was observed.

### 7.5 Surge at Power Port

Test Requirement: EN 61547:2009  
 Test Method: EN 61000-4-5:2014 +A1:2017  
 Performance Criterion: C  
 No. of surges: 5 positive at 90°, 5 negative at 270°.

#### 7.5.1 Test Setup Diagram

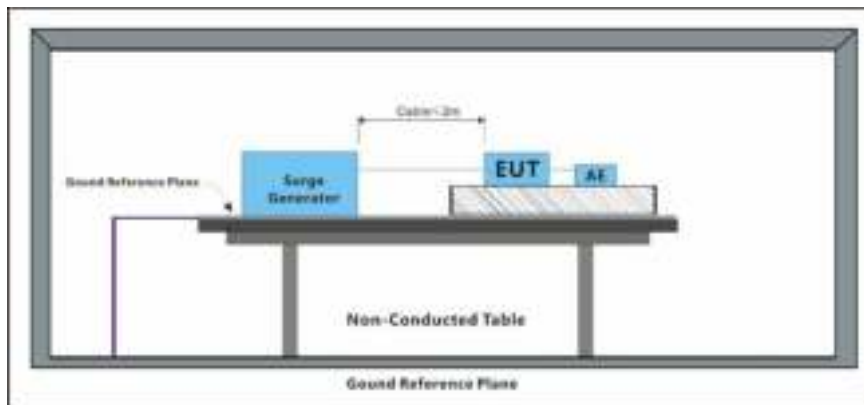

#### 7.5.2 E.U.T. Operation

Operating Environment:  
 Temperature: 22 °C      Humidity: 50 % RH      Atmospheric Pressure: 1020 mbar  
 Test mode: a: Lighting Mode: Keep the lamp lighting continuously.

#### 7.5.3 Test Results:

Test Line	Level (kV)	Polarity	Phase (deg)	Result / Observations
L-N	0.5	+	90°	A
L-N	0.5	-	270°	A

#### Results:

A: No degradation in the performance of the EUT was observed.

### 7.6 Conducted Immunity at Power Port (150kHz-80MHz)

Test Requirement: EN 61547:2009  
 Test Method: EN 61000-4-6:2014  
 Performance Criterion: A  
 Frequency Range: 0.15MHz to 80MHz  
 Modulation: 80%, 1kHz Amplitude Modulation  
 Step Size: 1%

#### 7.6.1 Test Setup Diagram

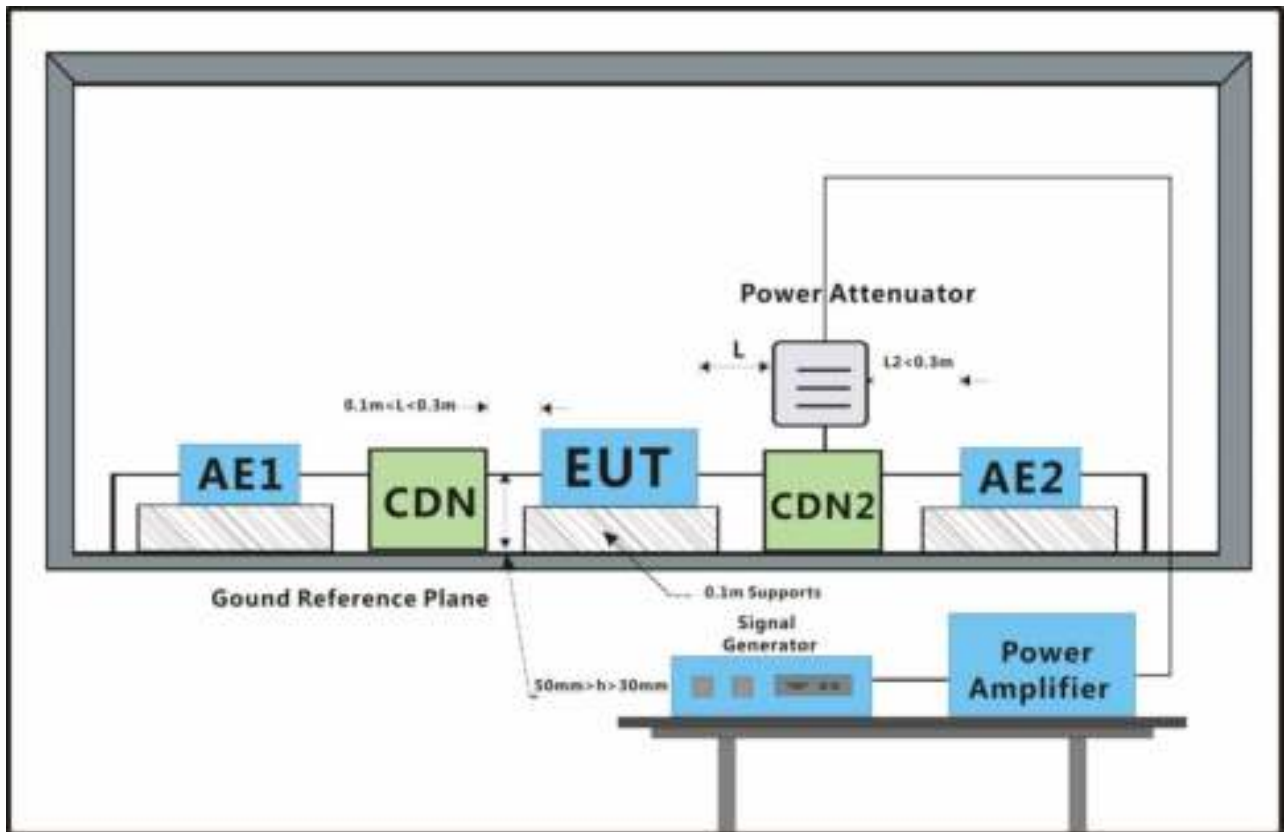

#### 7.6.2 E.U.T. Operation

Operating Environment:

Temperature: 22 °C      Humidity: 50 % RH      Atmospheric Pressure: 1002 mbar

Test mode: a: Lighting Mode: Keep the lamp lighting continuously.

#### 7.6.3 Test Results:

Cable port	Level (Vrms)	CDN/Clamp	Dwell time	Result / Observations
AC power port	3	CDN	2s	A

#### Results:

A: No degradation in the performance of the EUT was observed.

## 7.7 Voltage Dips and Interruptions

Test Requirement: EN 61547:2009  
 Test Method: EN 61000-4-11:2004 +A1:2017  
 Performance Criterion: 0% of UT (Supply Voltage) for 0.5 Periods:B; 70 % of UT for 10 Periods:C  
 No. of Dips / Interruptions: 3 per Level  
 Time between dropout 10s

### 7.7.1 Test Setup Diagram

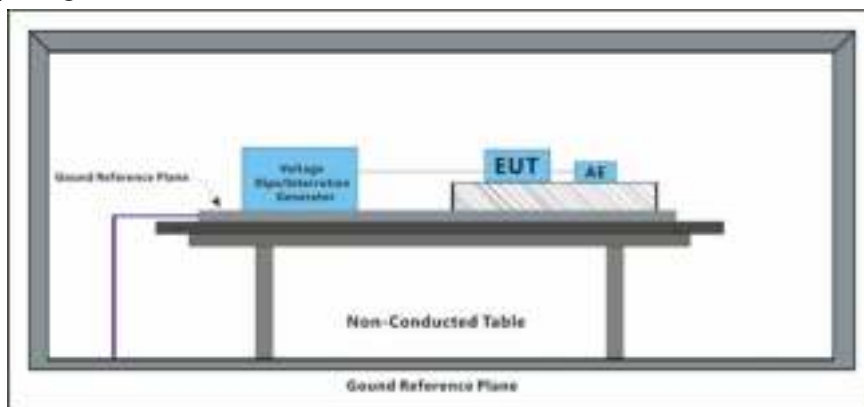

### 7.7.2 E.U.T. Operation

Operating Environment:  
 Temperature: 22 °C Humidity: 50 % RH Atmospheric Pressure: 1020 mbar  
 Test mode: a: Lighting Mode: Keep the lamp lighting continuously.

### 7.7.3 Test Results:

Level % UT	Phase (deg)	Duration	No. of Dips / Interruptions	Result / Observations
0	0°	0.5 Cycles	3	A
0	180°	0.5 Cycles	3	A
70	0°	10 Cycles	3	A
70	180°	10 Cycles	3	A

#### Results:

A: No degradation in the performance of the EUT was observed.

## 8 Photographs

### 8.1 Conducted Emissions at Mains Terminals (9kHz-30MHz) Test Setup



### 8.2 Radiated Emissions (30MHz-300MHz) Test Setup



### 8.3 Radiated Emissions (Magnetic field Induced Current)(9kHz-30MHz) Test Setup



### 8.4 Voltage Fluctuations and Flicker Test Setup



### 8.5 Electrostatic Discharge Test Setup



### 8.6 Radiated Immunity (80MHz-1GHz) Test Setup





### 8.7 Electrical Fast Transients/Burst at Power Port Test Setup



### 8.8 Surge at Power Port Test Setup

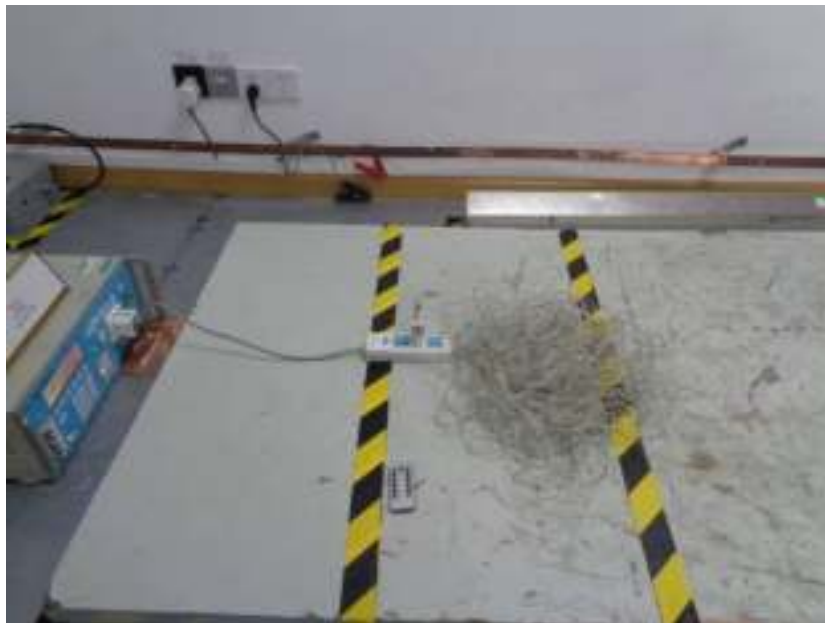



### 8.9 Conducted Immunity at Power Port (150kHz-80MHz) Test Setup



### 8.10 Voltage Dips and Interruptions Test Setup

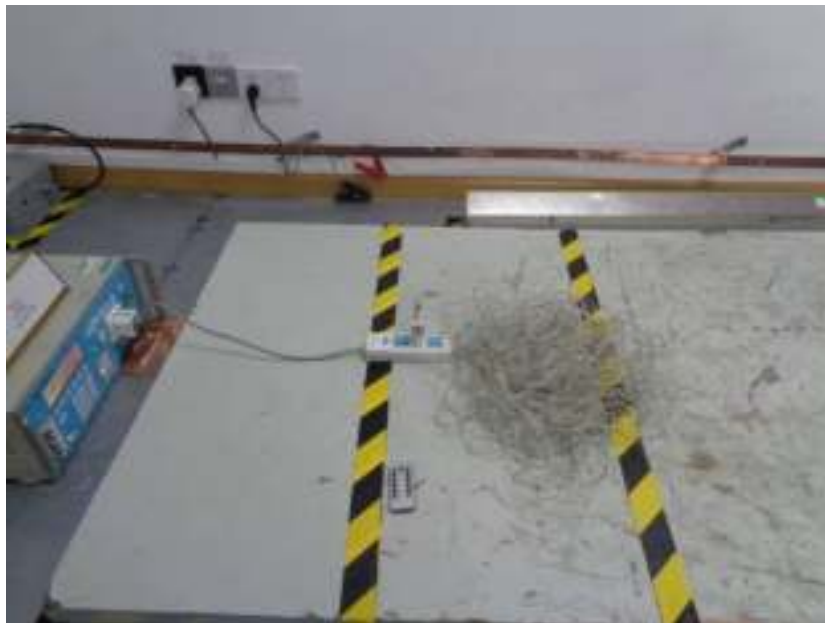

### 8.11 EUT Constructional Details (EUT Photos)

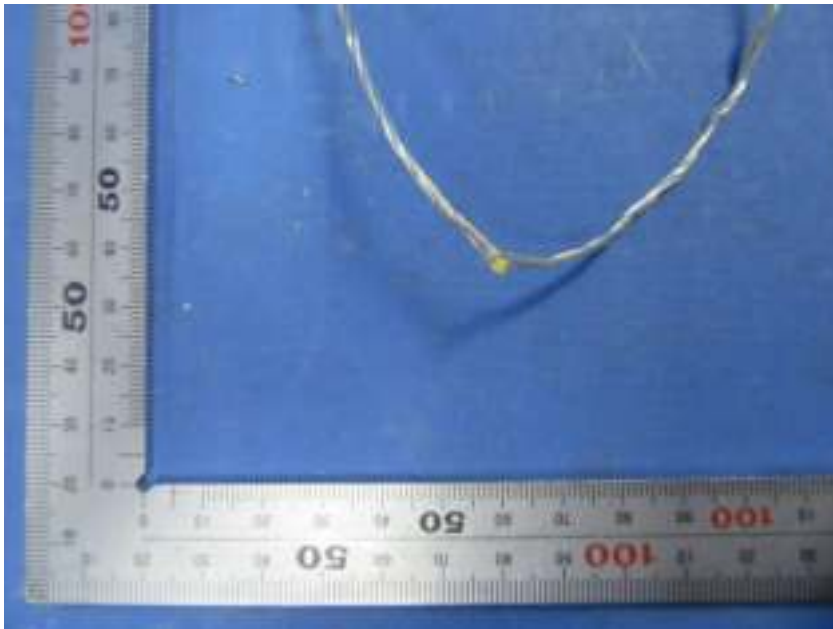

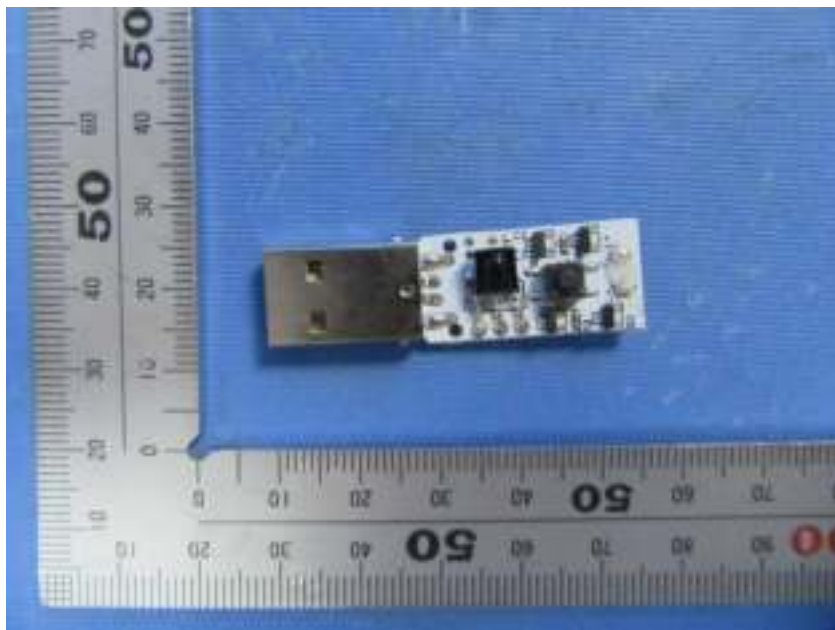

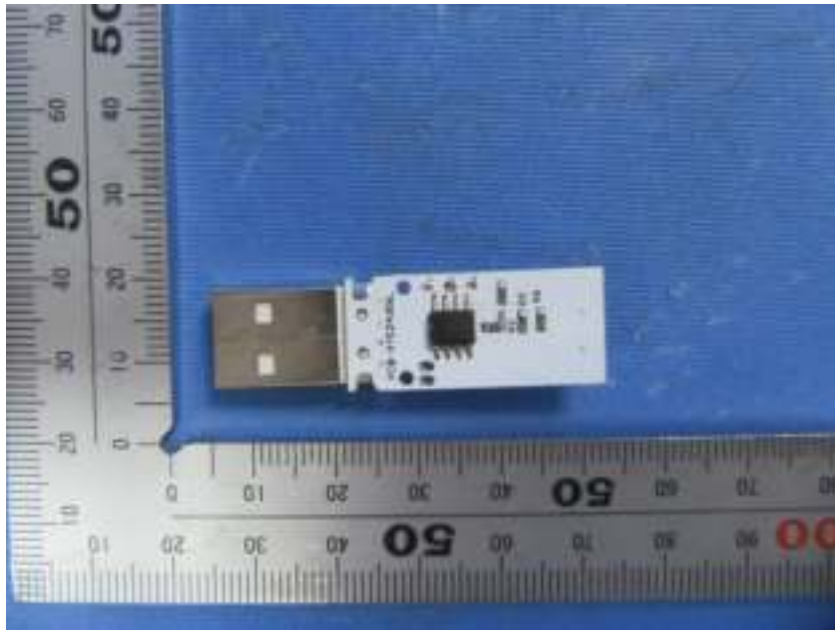

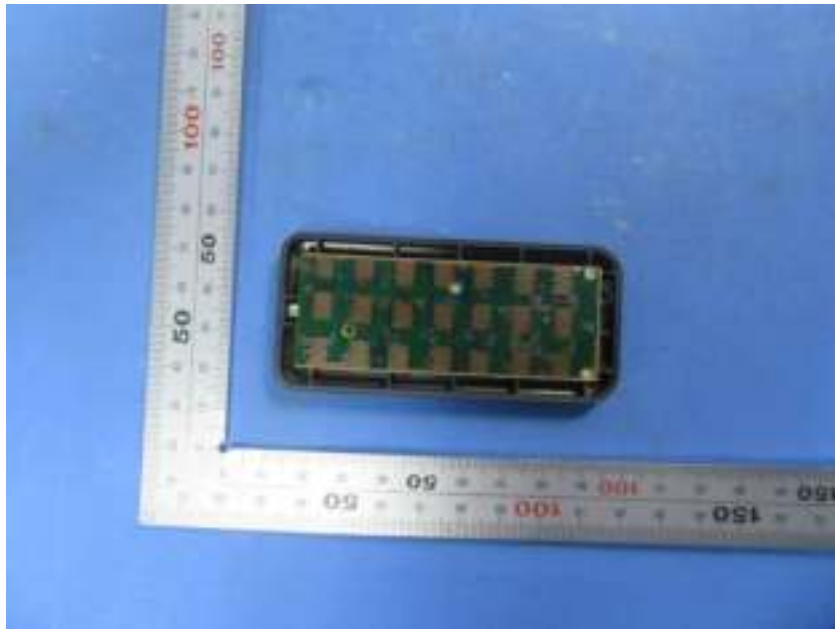



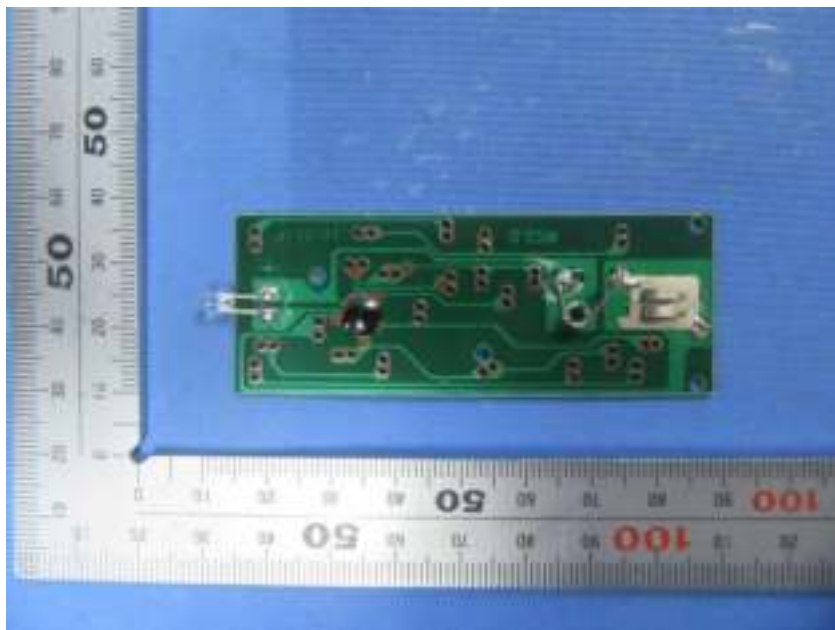
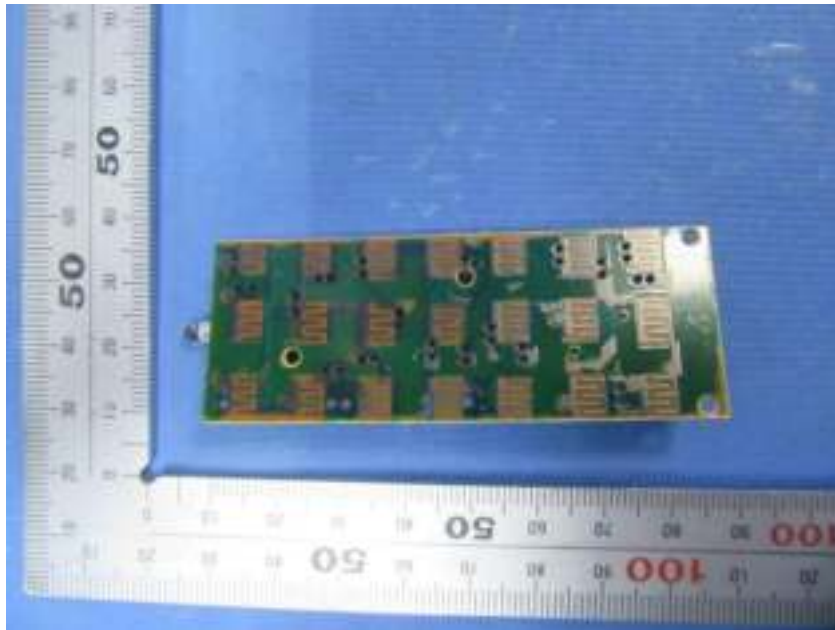



- End of the Report -