

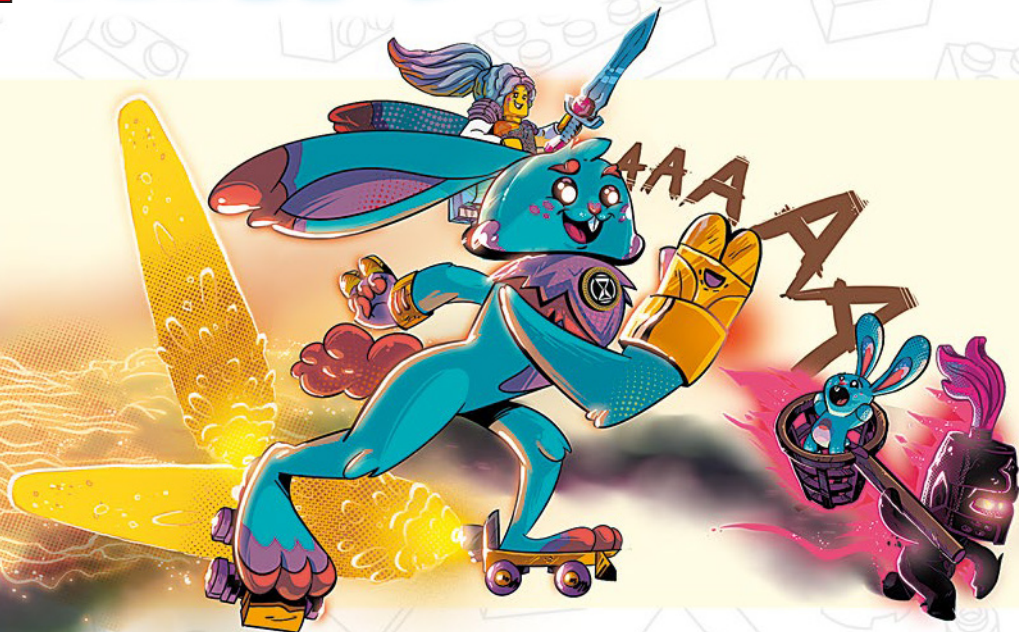

# DREAMZZZ

71453





FR  
**DONNEZ**  
OU  
**RECYCLEZ**

ASSOCIATION OU MAGASIN OU DÉCHÈTERIE

Adresses sur [quefairedemesdechets.fr](http://quefairedemesdechets.fr)



[LEGO.com/sustainable-packaging](https://LEGO.com/sustainable-packaging)



# BUILDER



Apple and the Apple logo are trademarks of Apple Inc., registered in the U.S. and other countries and regions. App Store is a service mark of Apple Inc. Google Play and the Google Play logo are trademarks of Google LLC. Tencent and the Tencent logo are trademarks of Tencent Inc.

Q [LEGO.com/devicecheck](https://www.lego.com/devicecheck)

**EN** Ask parents' permission before going online | **DE** Eltern um Erlaubnis bitten, bevor du online gehst | **FR** Demande l'autorisation d'un parent avant d'aller en ligne | **IT** Chiedi il permesso ai tuoi genitori prima di andare online | **ES** Pídeles permiso a tus papás antes de conectarte a Internet | **PT** Peça autorização aos pais antes de acederes online | **ZH** 上网前应先征得父母的同意 | **PL** Poproś rodziców o zgodę, zanim wejdiesz do Internetu | **CS** Než půjdeš na internet, požádej rodiče o svolení | **SK** Skôr než pôjdeš na internet, vypýtaj si povolenie od rodičov | **HU** Kérj szülői engedélyt, mielőtt online csatlakoznál! | **RO** Cere permisiunea părinților înainte de a te conecta online | **BG** Поискайте разрешение от родител, преди да влезете онлайн | **LV** Pirms došanās tiešsaistē palūdz atļauju vecākiem | **ET** Enne Interneti kasutamist küsi vanematelt luba | **LT** Prieš prisijungdami prie interneto, atsiklauskite tėvų





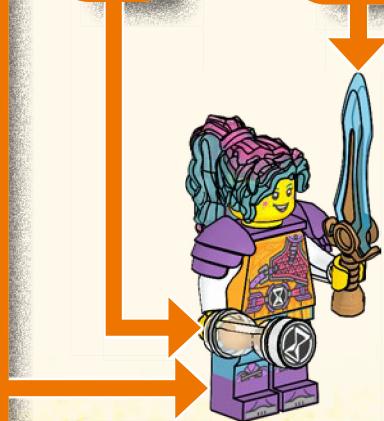
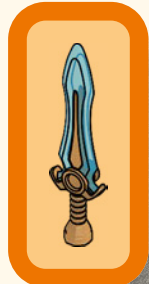
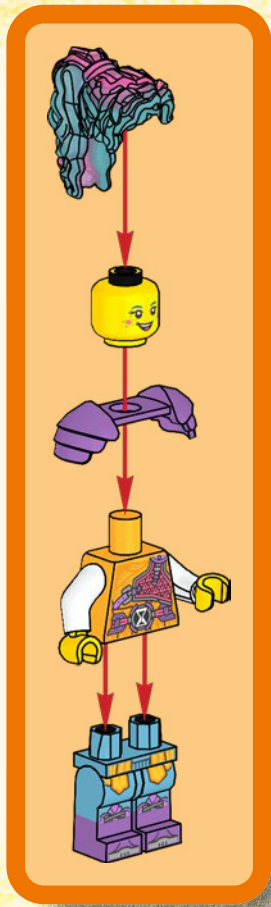

WUHAAA



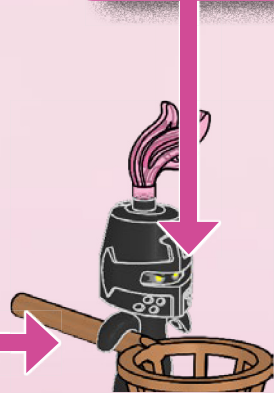
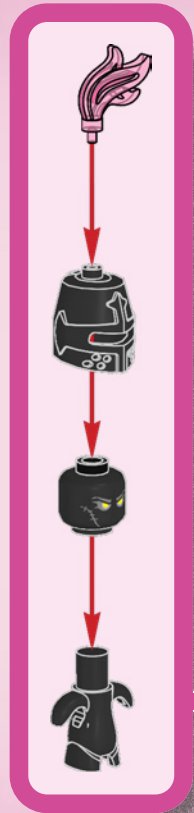





ZBAR

AAAWAA

FRRRRtwh



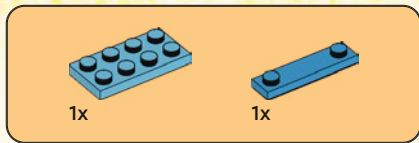

1

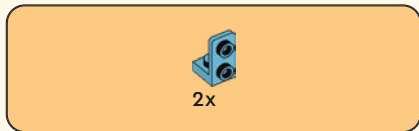
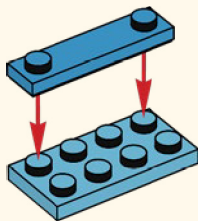

2

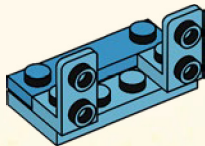

3

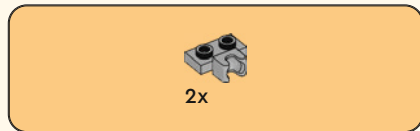
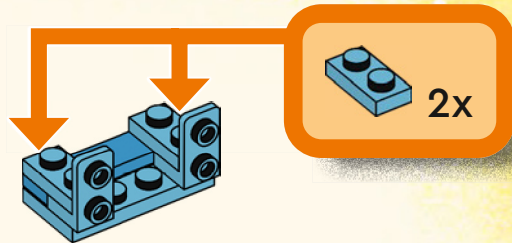

4

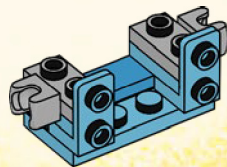



2x

5

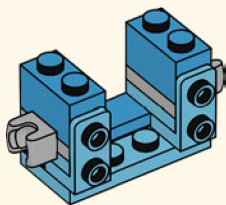

4x

6

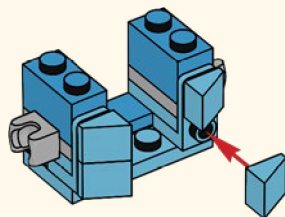

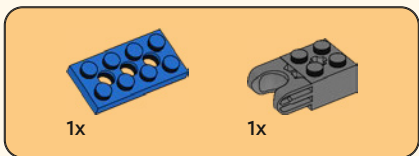
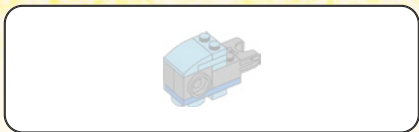

7

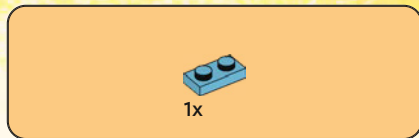
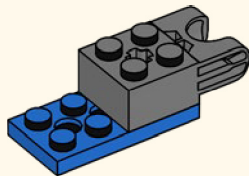

8

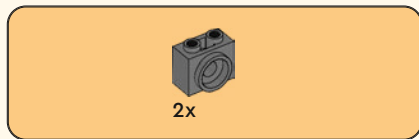
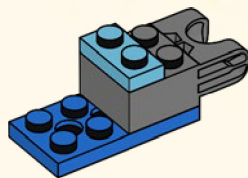

9

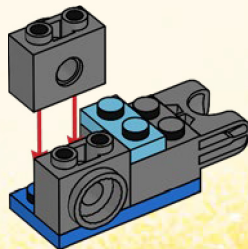



1x



1x

10

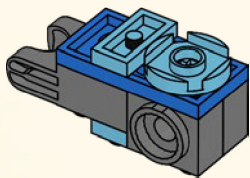

1x

11

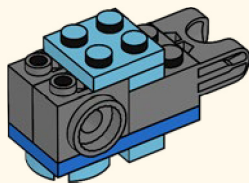



1x



1x

12

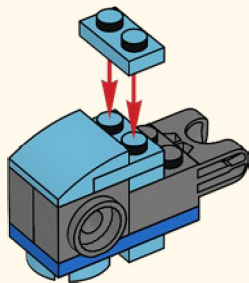

13

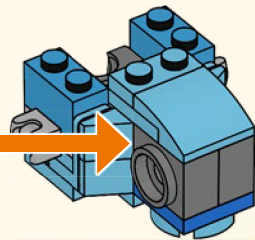



1x

# 14

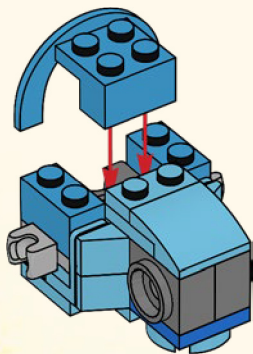

2x



1x

# 15

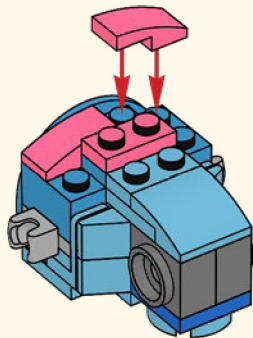





16

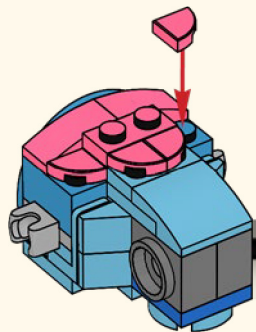

1x

17

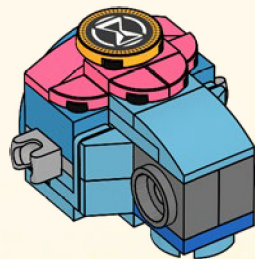

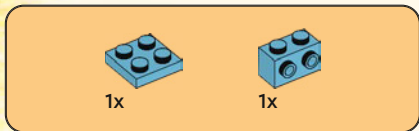

18

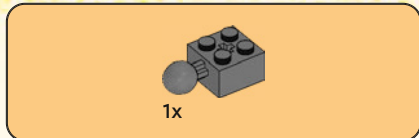
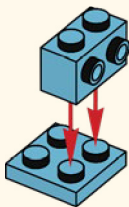

19

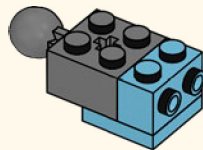



2x

20



2x

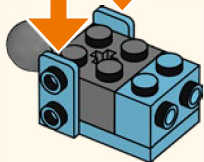

1x



2x

21

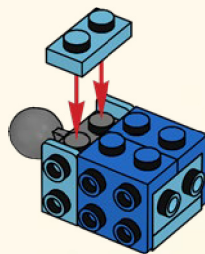



4x

22

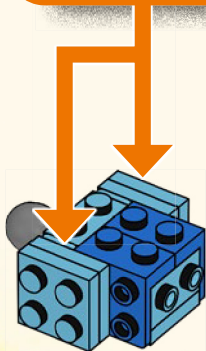
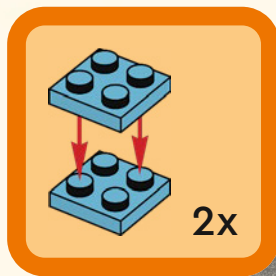

2x

23

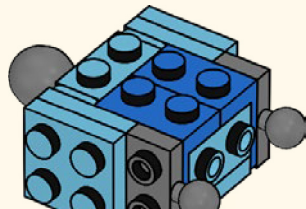



1x



1x

24

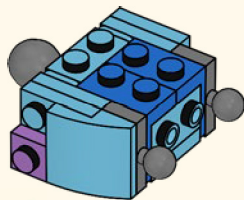

1x



1x

25

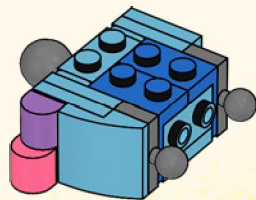



1x



1x

26

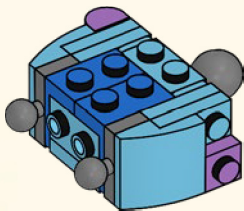

1x



1x

27

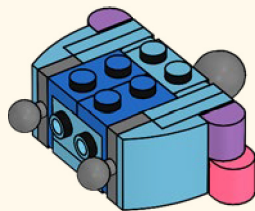

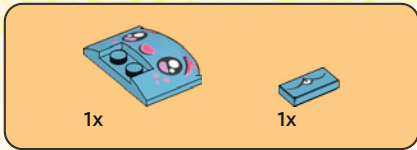

28

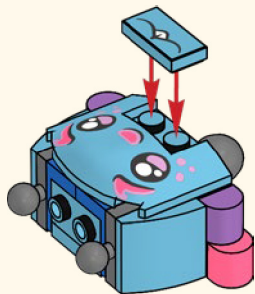

29

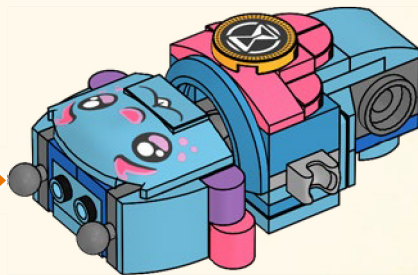

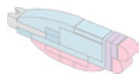

2x



1x



1x

30

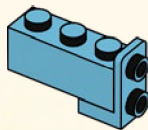

1x

31

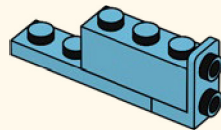





2x

32

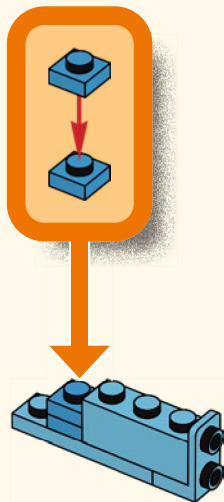

1x



1x

33

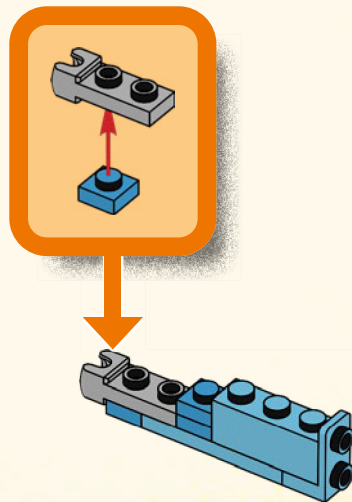

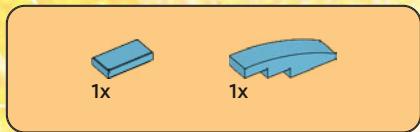

34

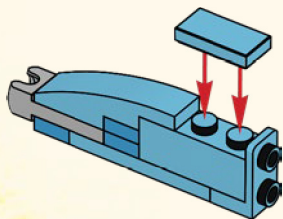

35

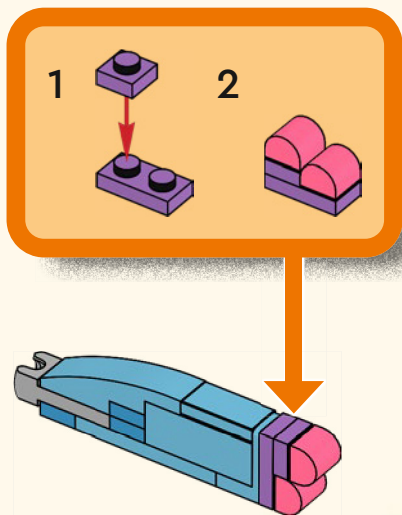



36

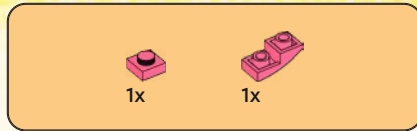
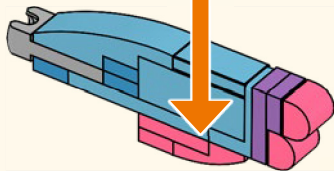
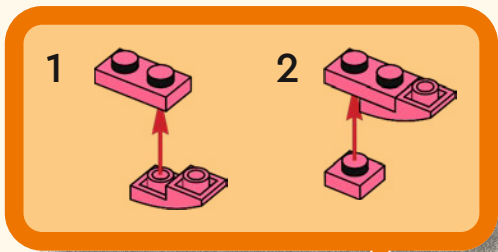

37

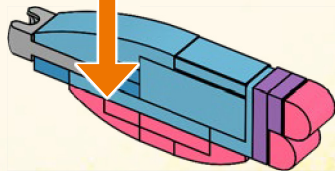
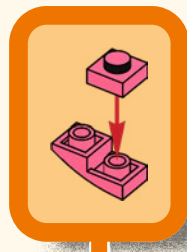

2x

38

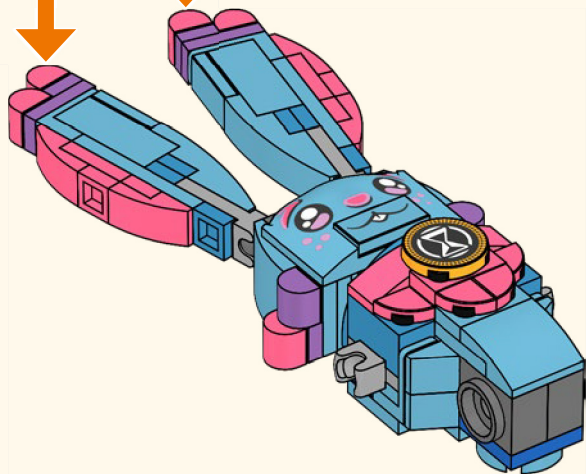





2x



1x



1x

39

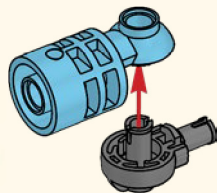

1x

40

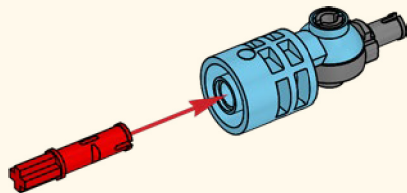



41

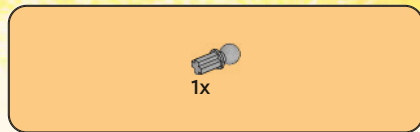
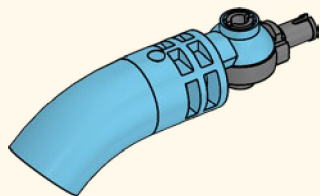

42

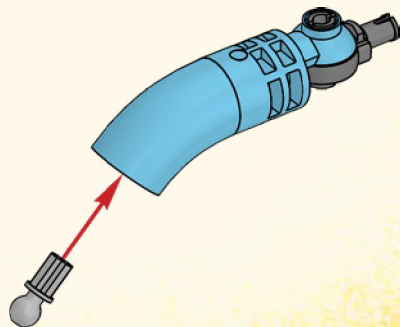

2x

43

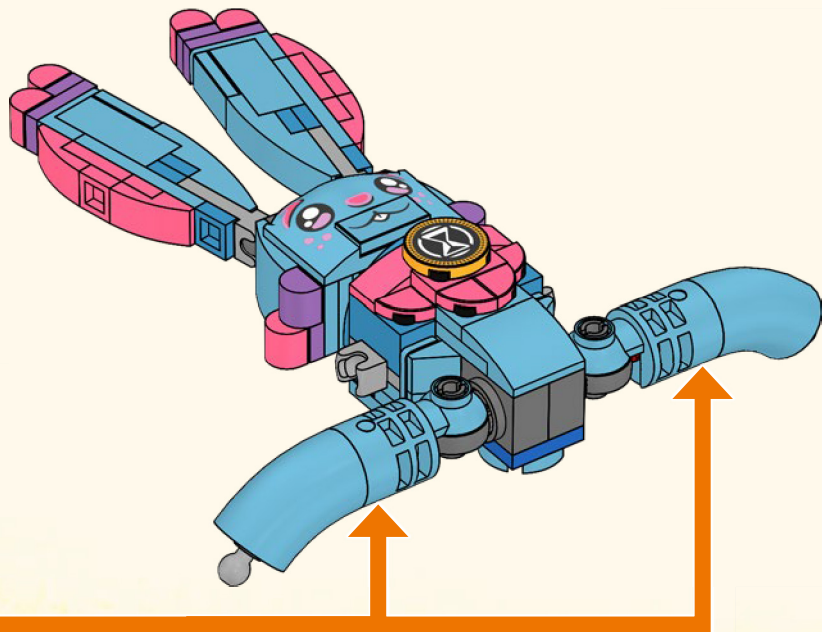



44

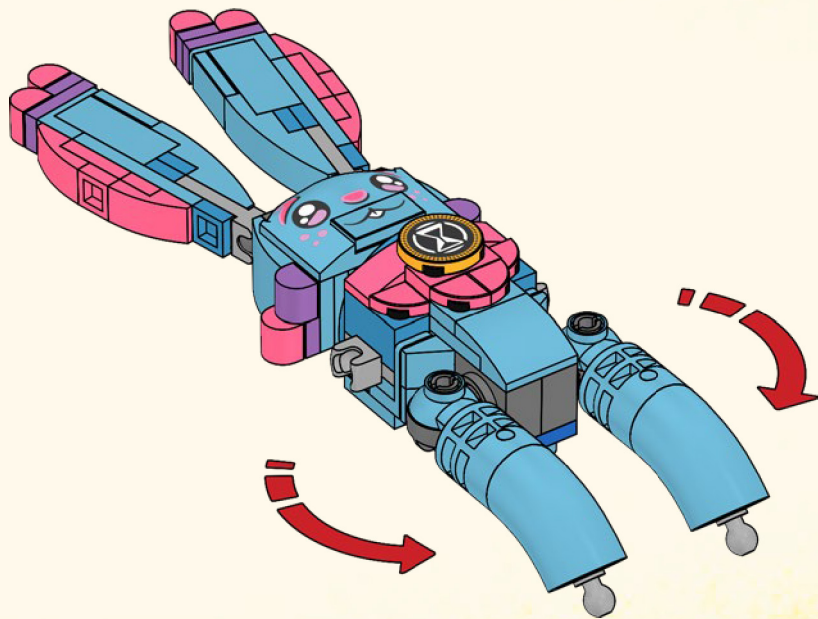

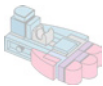

1x



1x

45

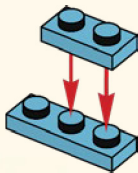

1x



1x

46

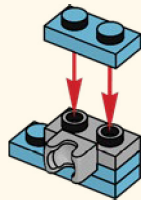



1x

47

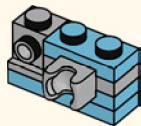

1x



1x



1x



1x

48

1

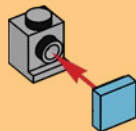

2

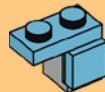

3

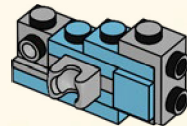
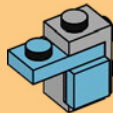



1x

49

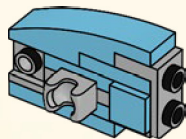

1x



1x



1x

50

1

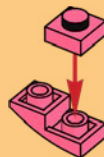

2

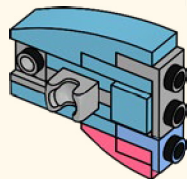



1x



1x

51

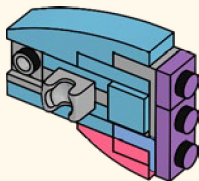

3x



1x

52

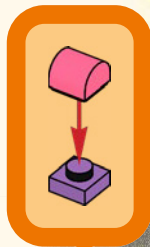
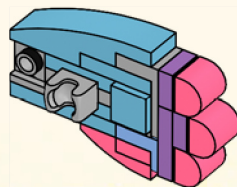



53

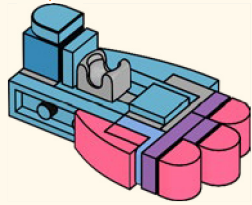
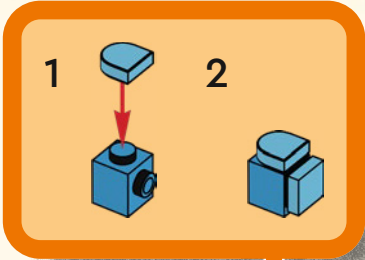

54

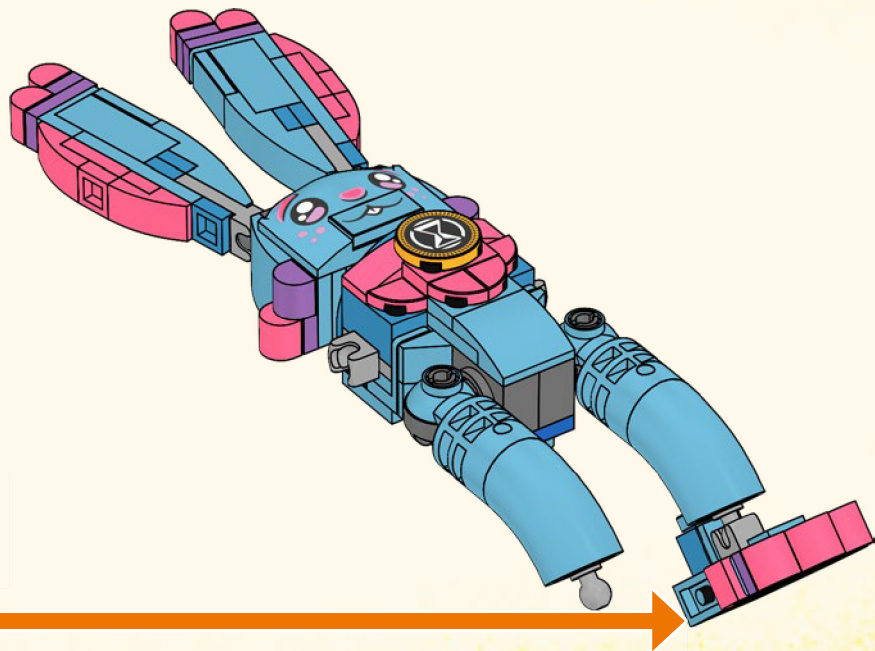

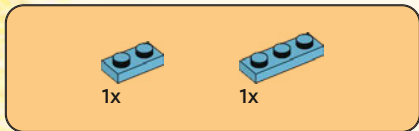
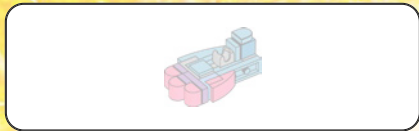

55

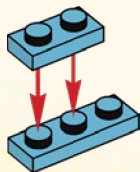

56

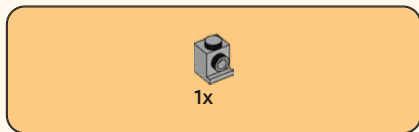
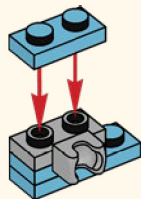

57

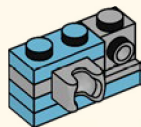



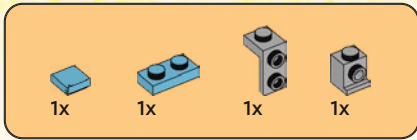

58

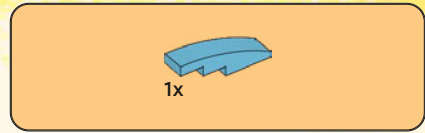
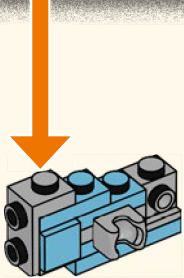
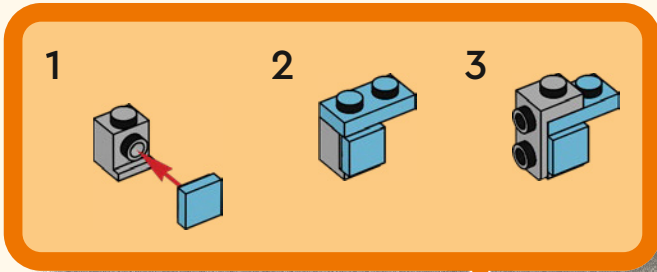

59

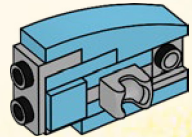



60

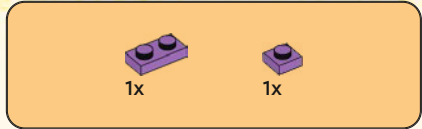
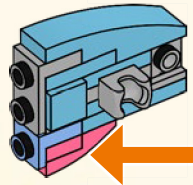
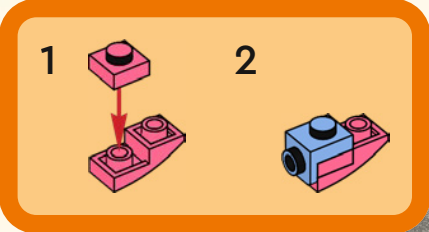

61

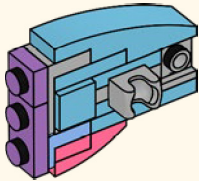



3x



1x

62

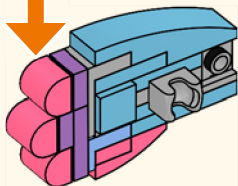
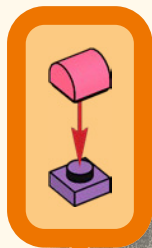

1x



1x



1x

63

1



2

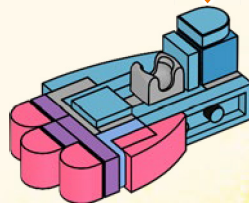

64

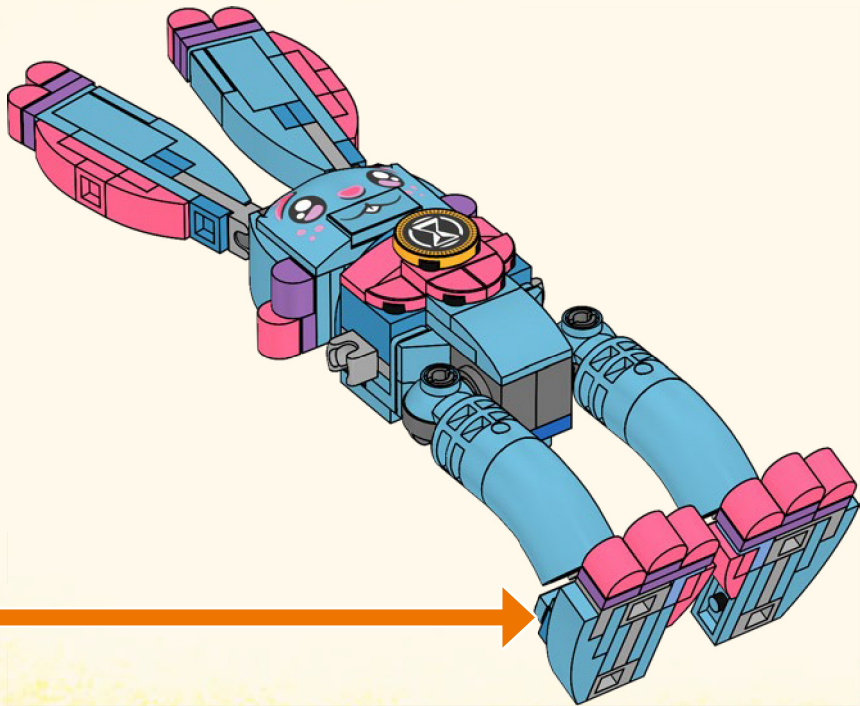

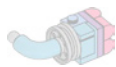

1x



1x

65

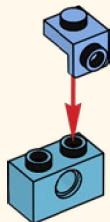

1x

66

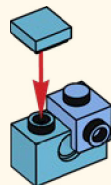

1x

67





68

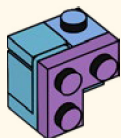

69

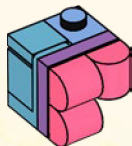

70

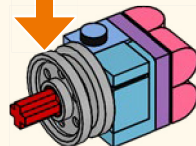
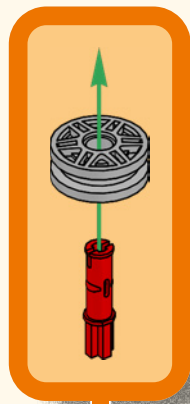

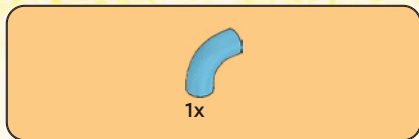

71

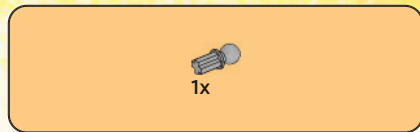
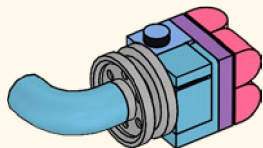

72

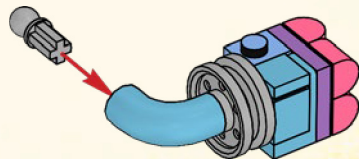

73

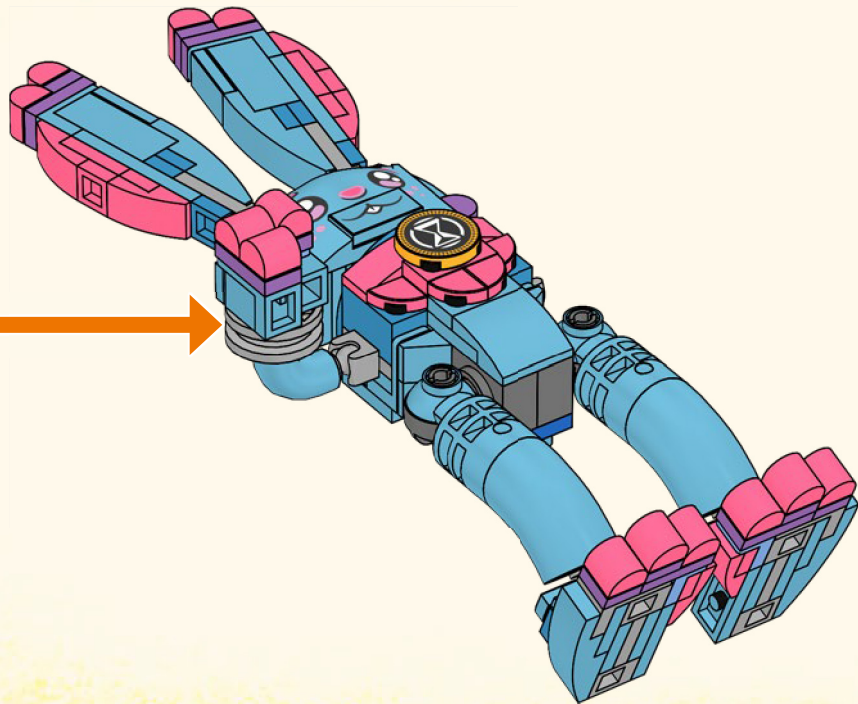





1x



1x

74

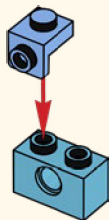

1x

75

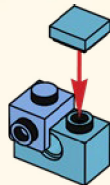

1x

76

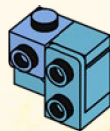



1x

77

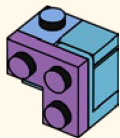

3x

78

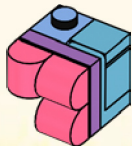

1x



1x

79

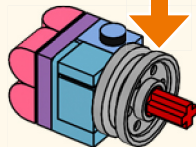
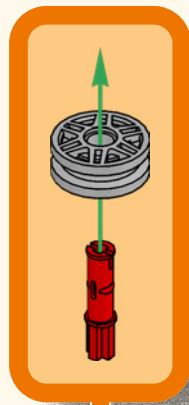

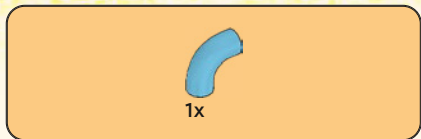

80

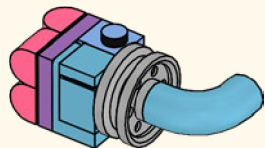

81

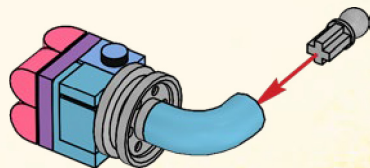

82

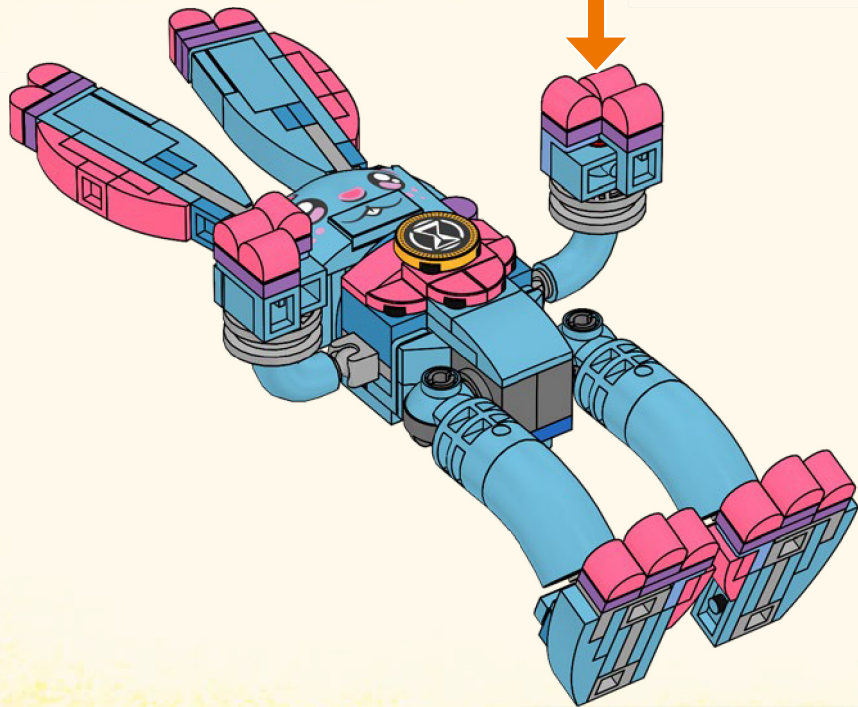



1x

83

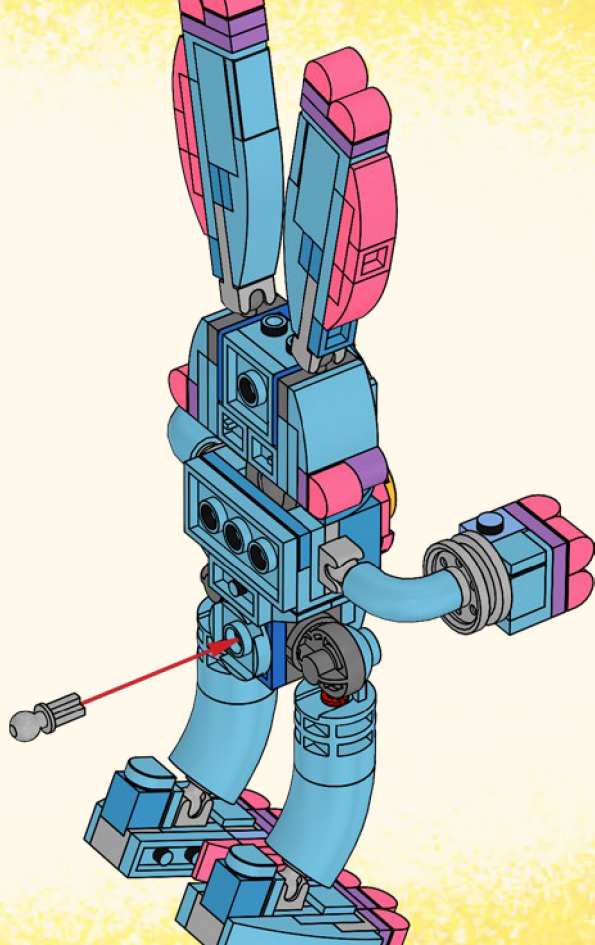

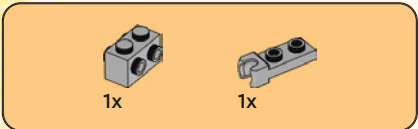

84

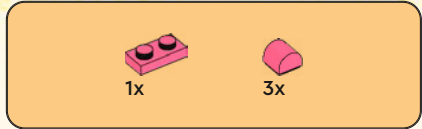
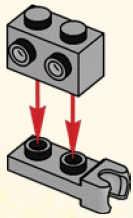

85

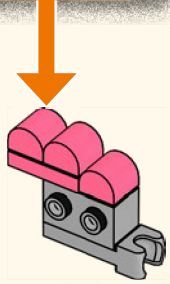
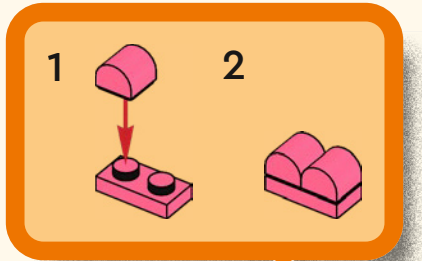



1x



1x

86

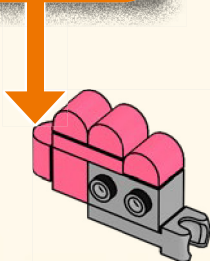
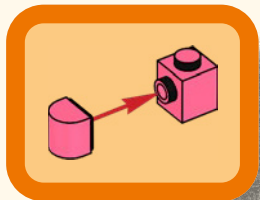

1x



1x

87

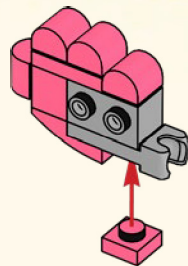

2x

88

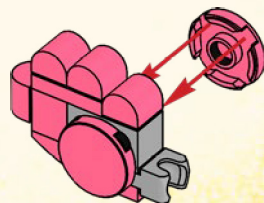

89

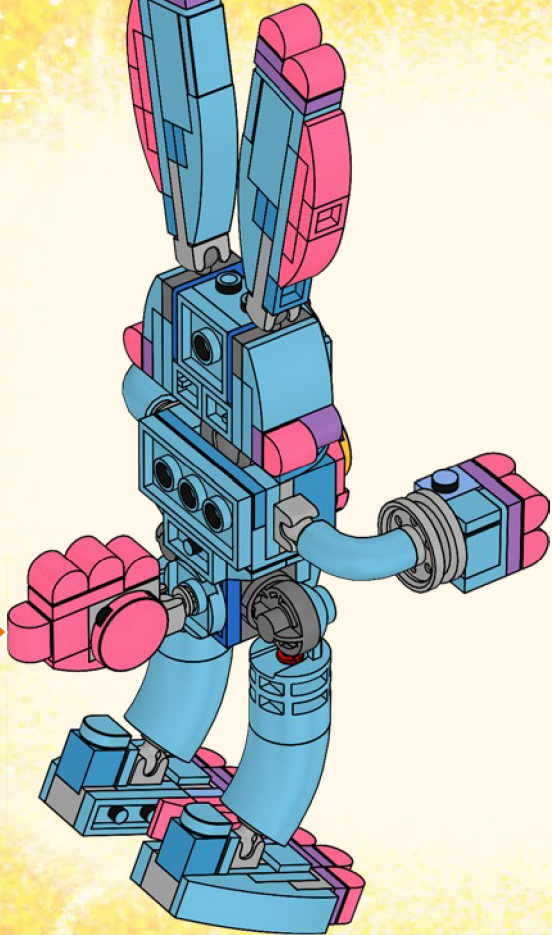

56





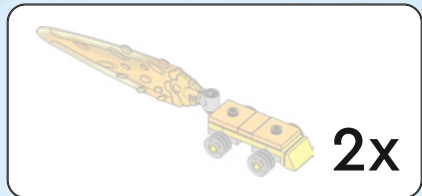

1

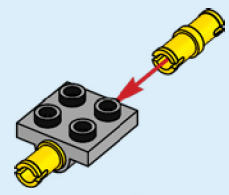



1x

2

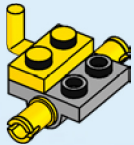

1x

3

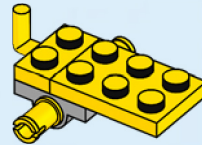



4

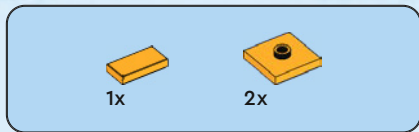
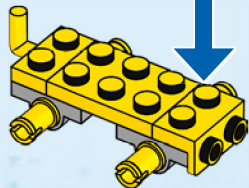
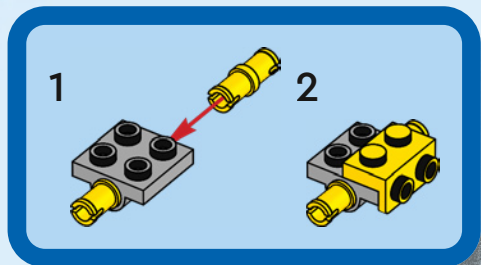

5

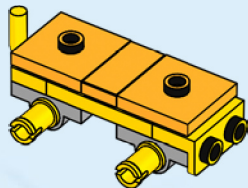



1x

6

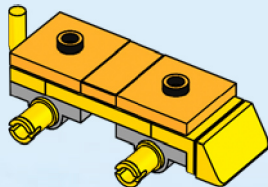

4x

7

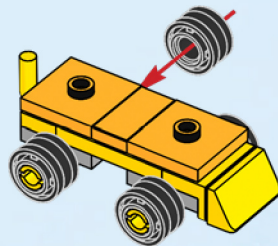

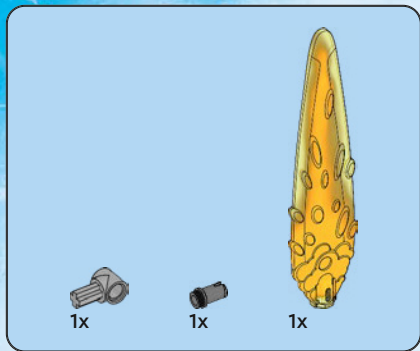

8

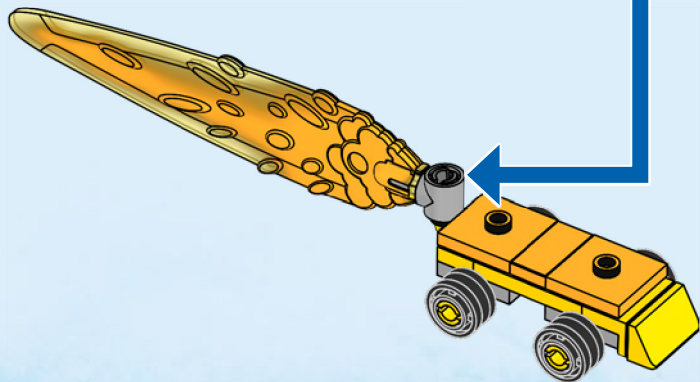
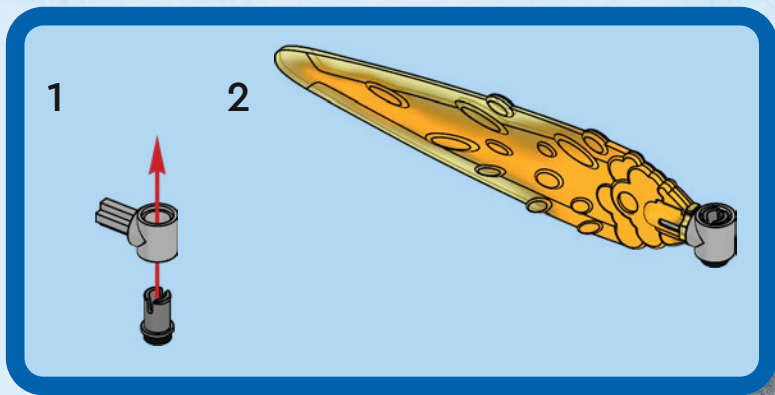

2x

9

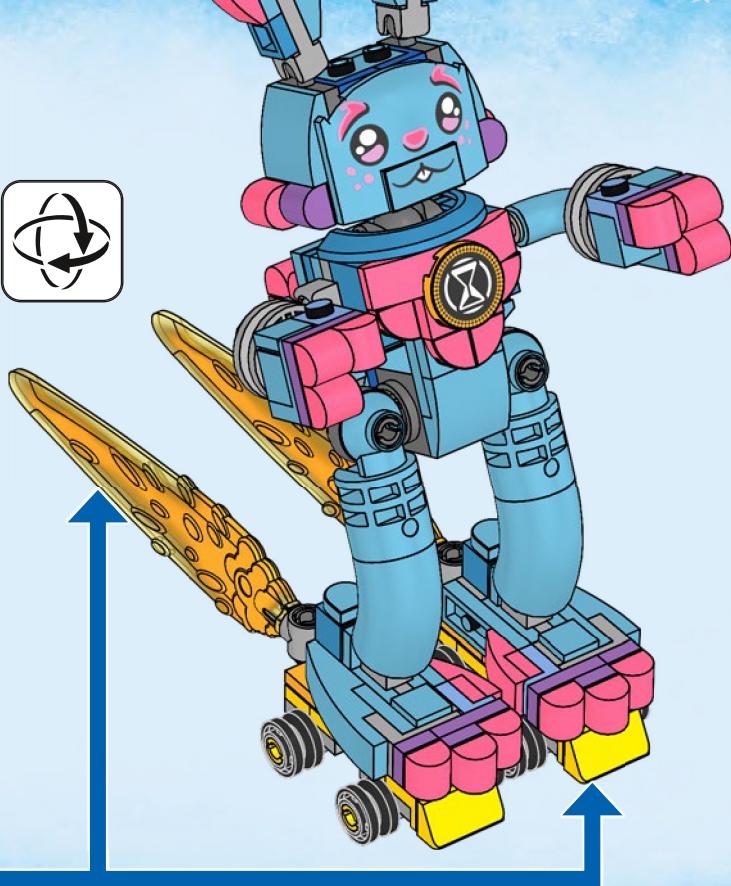



10

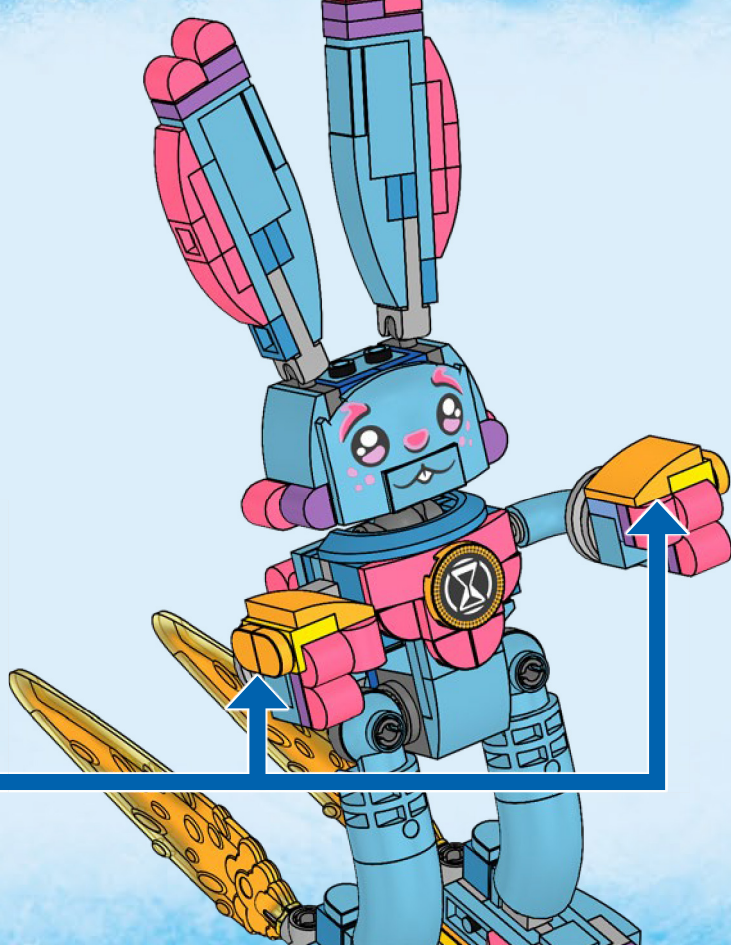
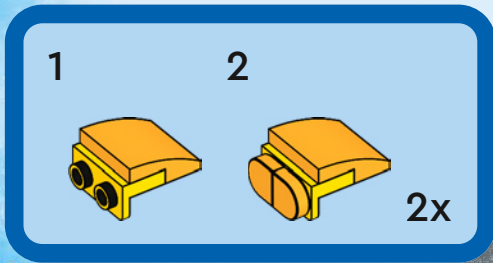





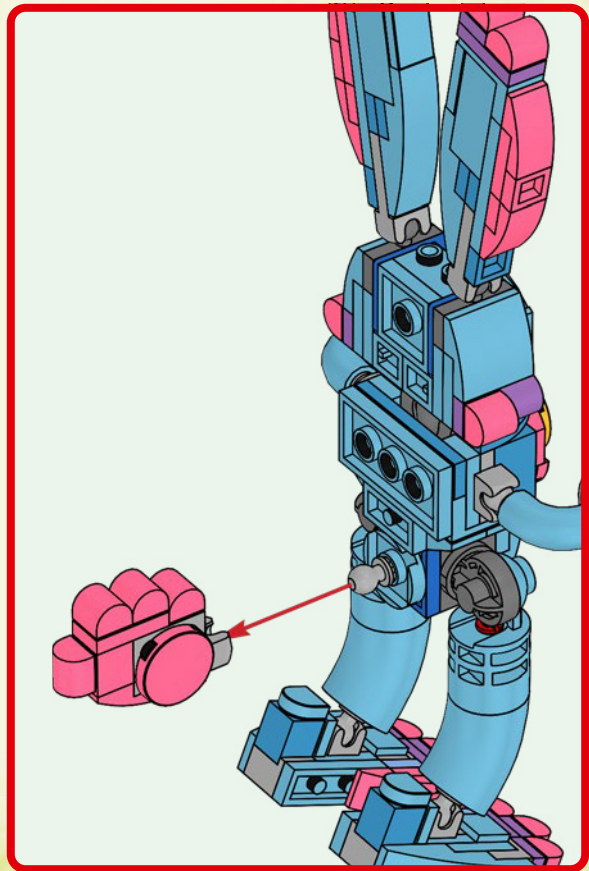

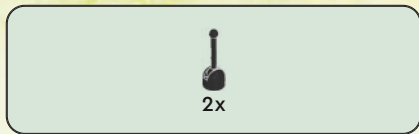

1

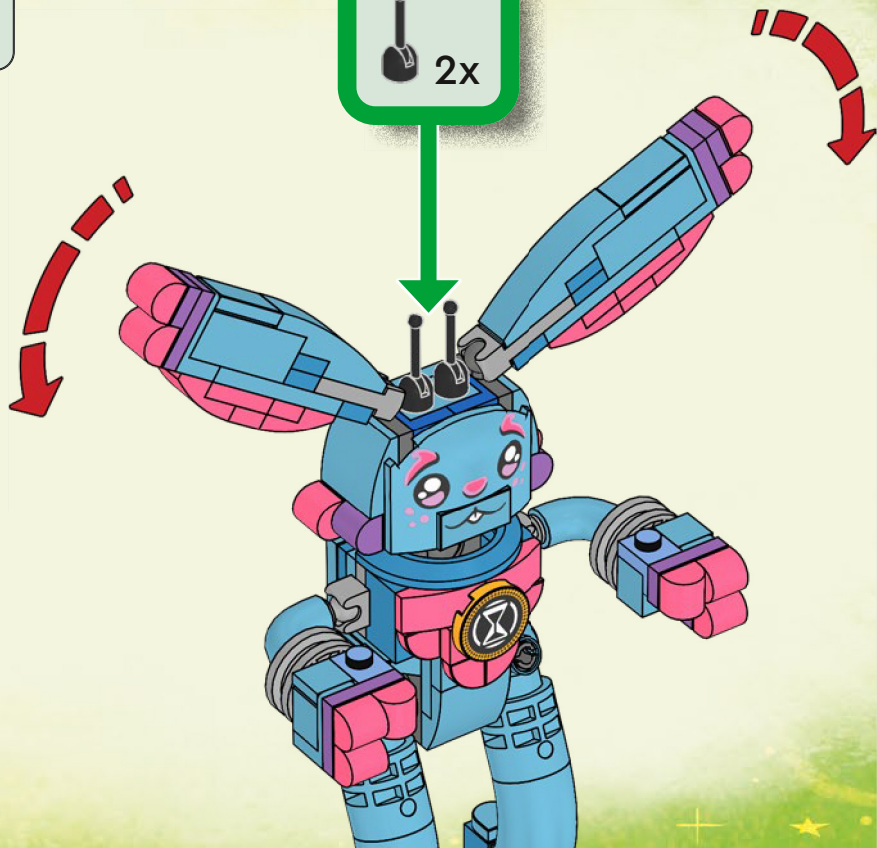
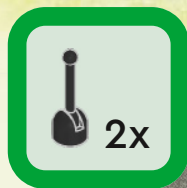



1x



1x

2



1x

3

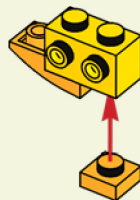

1x

4

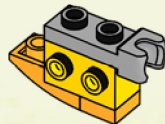



1x

5

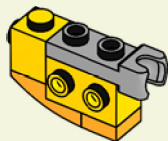

1x



1x

6

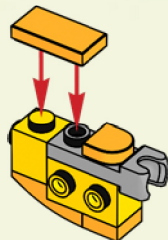

2x

7

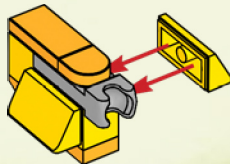



8

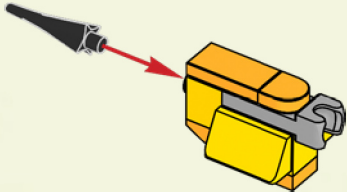

9

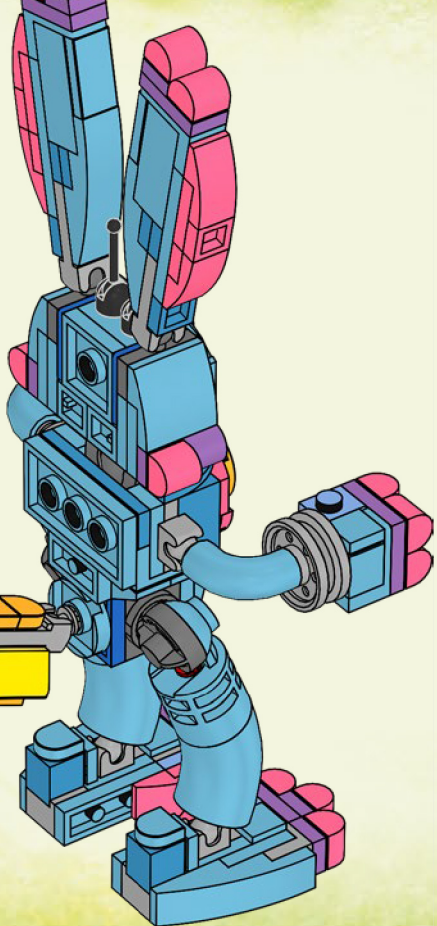

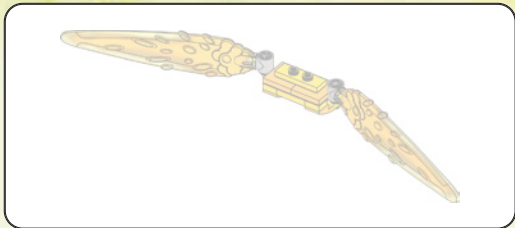

10



11

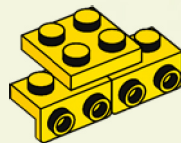

12

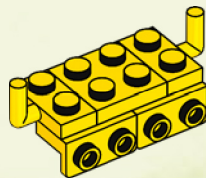



2x

13

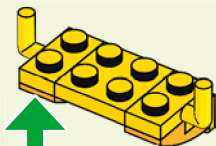

2x



2x

14

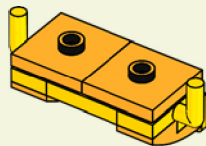

1x

15

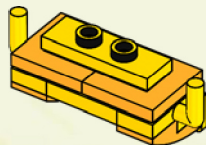



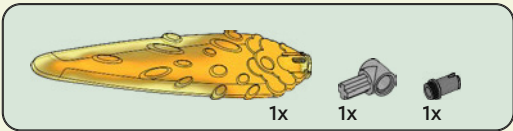

16

1

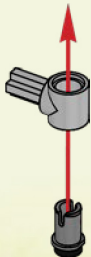

2

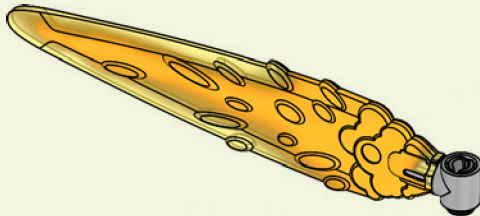

2x

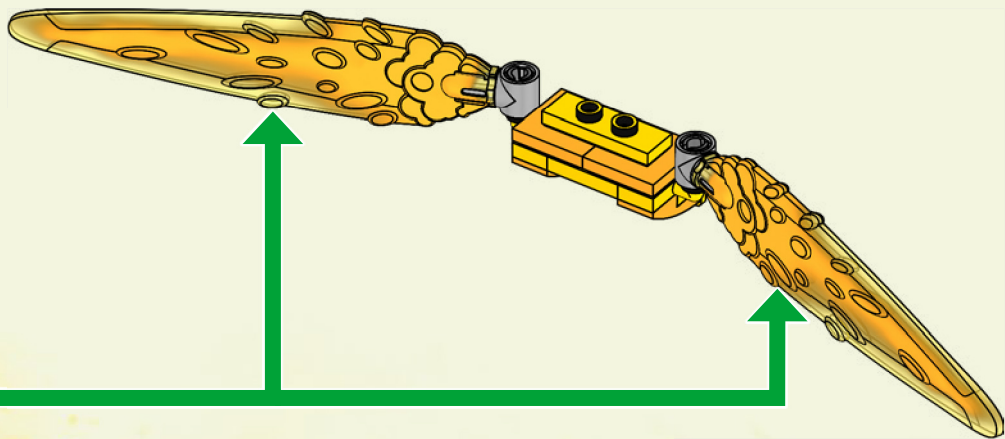

17

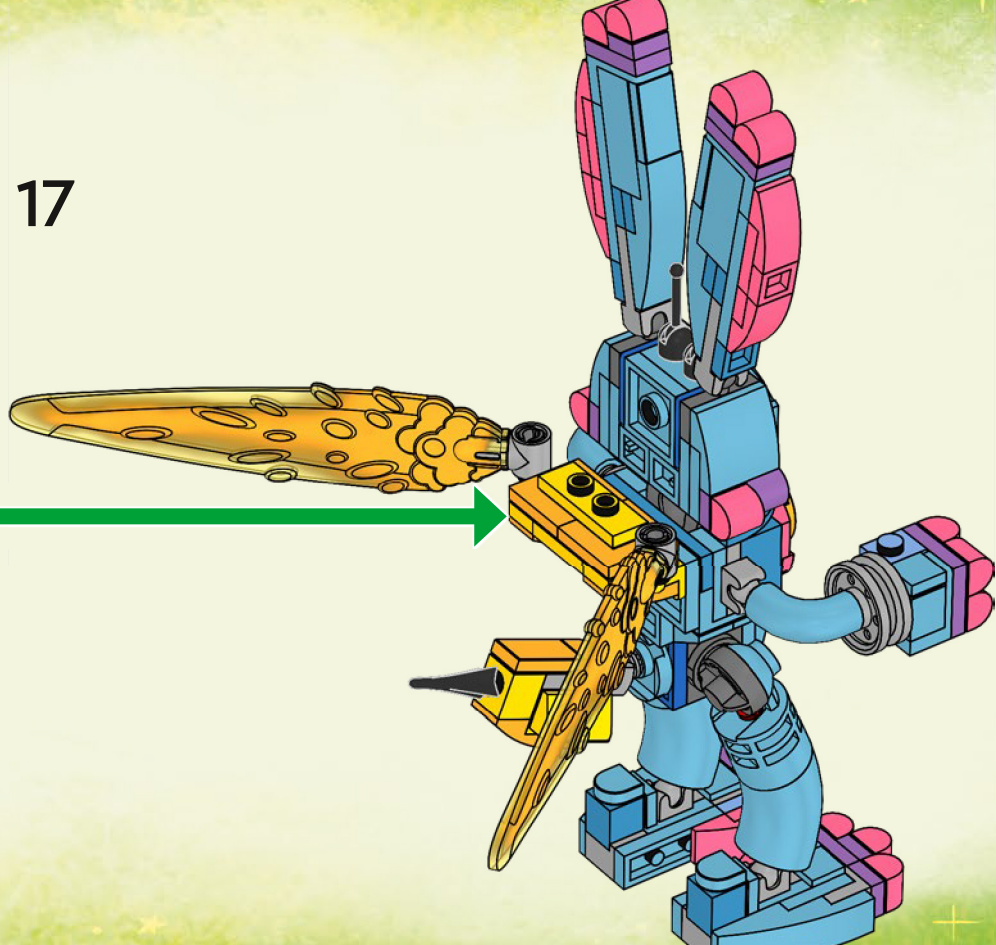

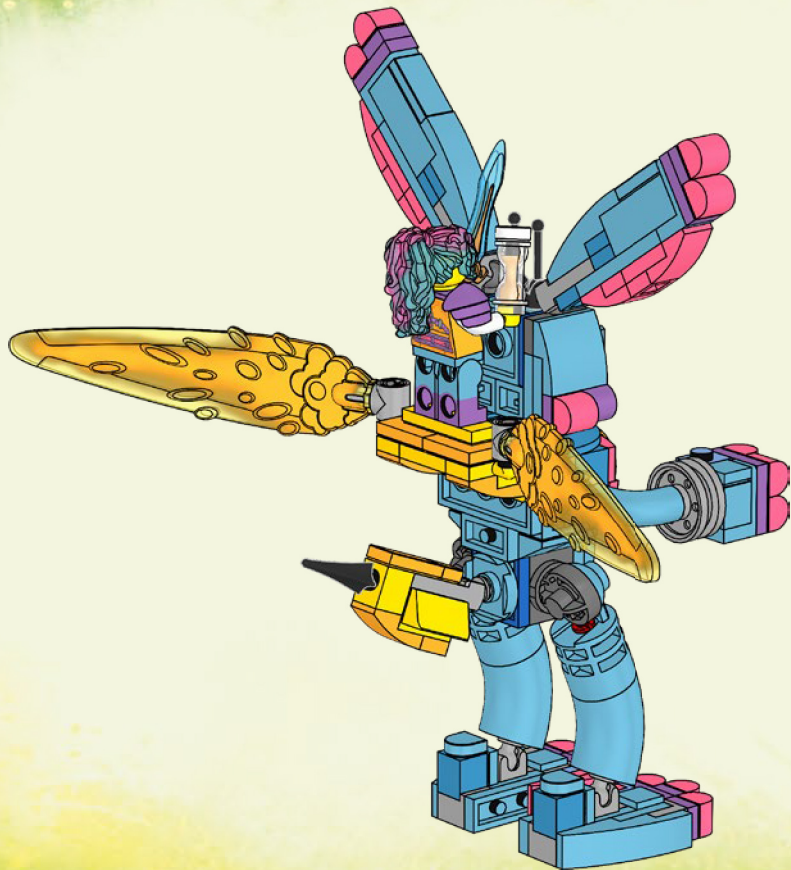



**LEGO**

# DREAMZZZ



**71453**



**71454**



**71455**



**71459**



**71460**



71456



71457



71458



71461



71469

Watch series online  
Schau dir die Serie online an  
Regarde la série en ligne  
Guarda la serie online  
Mira la serie en Internet  
Assistir à série online  
在线观看  
Oglądaj serial w internecie  
Sleduj seriál online  
Pozri si seriál online  
Nézd a sorozatot online  
Vizionează serialul online  
Глядите сериала онлайн  
Skaties seriālu tiešsaistē  
Vaata sarja veebist  
Žiūrėk serialą internetu



**LEGO**



**DREAMZZZ**



**WATCH  
SERIES  
ONLINE**



[LEGO.com/DREAMzzz](https://www.lego.com/DREAMzzz)





Rebuild  
the  
world™





1x  
6434196



4x  
6209519



2x  
6117968



1x  
370923



1x  
6434190



1x  
4624985



2x  
4550348



8x  
6331822



1x  
6289719



2x  
6261356



4x  
6185994



1x  
302224



1x  
6228602



2x  
302124



1x  
6269965



2x  
73587



1x  
6434214



1x  
6349966



8x  
6291068



1x  
6430884



1x  
6440804



2x  
6447085



4x  
6248079



1x  
6303223



4x  
6313554



1x  
6073040



1x  
6434197



3x  
6145215



3x  
4622062



4x  
6193972



2x  
6099730



1x  
6443633



4x  
4211476



2x  
6362975



5x  
6443149



2x  
6123815



1x  
4657459



4x  
6043656



2x  
6044729



4x  
6043639



4x  
4211376



1x  
6253187



2x  
6395635



2x  
6398662



2x  
6039479



2x  
4522784



1x  
4497253



1x  
6338291



1x  
6430886



8x  
4619521



2x  
6261546



4x  
4619512



2x  
4619517



1x  
6443457



2x  
6004938



1x  
6133729



1x  
6254046



6x  
6151664



2x  
6004943



4x  
6250022



22x  
6422223



7x  
6258091



1x  
6261292



7x  
6438408



2x  
6258405



4x  
6258094



2x  
6258075



2x  
6375606



1x  
6430878



4x  
4619520



6x  
4655243



8x  
6369798



1x  
6109752



2x  
6369800



1x  
6434193



2x  
6322828



1x  
6434198



1x  
6348142



2x  
4649741



6x  
4625032



3x  
6119126



2x  
6119107



2x  
6223734



2x  
6447228



4x  
6347671



2x  
6070757



1x  
6434195



1x  
4655256



1x  
6434192



12x  
6097419



2x  
6322807



[LEGO.com/service](https://www.lego.com/service)

**YOU COULD**  
**WIN**



Scan this QR code or go to  
**LEGO.COM/PRODUCTFEEDBACK** and give  
us your short feedback about this LEGO® set  
for a chance to win a cool LEGO prize.

Terms and Conditions apply\*



**EN: YOU COULD WIN.** Terms and Conditions apply\* **DE: Du könntest GEWINNEN.** Es gelten die Teilnahmebedingungen\* **FR: Tu pourrais GAGNER.** Des conditions s'appliquent\* **IT: Potresti VINCERE tu.** Termini e condizioni sono applicabili\* **ES: Puedes GANAR.** Aplican términos y condiciones\* **PT: Poderá GANHAR.** Aplicam-se termos e condições\* **ZH: 轻松获奖. 条款和条件适用\*** **PL: Szansa na WYGRANĄ.** Obowiązują warunki korzystania\* **CS: Máte šanci VYHRÁT.** Platí všeobecné smluvní podmínky\* **SK: Máte šancu VYHRAŤ.** Platia všeobecné zmluvné podmienky\* **HU: TE IS NYERHETSZ.** Felhasználási feltételek érvényesek\* **RO: Ai putea CÂȘTIGA.** Se aplică termenii și condiții\* **BG: Можете да СПЕЧЕЛИТЕ.** Има определени правила и условия\* **LV: Tu vari LAIMĒT.** Ir spēkā noteikumi un nosacījumi.\* **ET: Sul on võimalus VÕITA.** Kehtivad tingimused\* **LT: Jūs galite LAIMĖTI.** Taikomos sąlygos\*

\*[LEGO.com/productfeedback-terms](https://www.lego.com/productfeedback-terms)