



C3224, C3326, C3426, CS331, CS431 Printers

User's Guide

April 2020

www.lexmark.com

Machine type(s):

1500

Models:

218, 638, 836, 8c6

Contents

- Safety information..... 5**
 - Conventions..... 5
 - Product statements..... 5

- Learn about the printer..... 8**
 - Finding information about the printer.....8
 - Printer configurations..... 10
 - Using the control panel.....11
 - Customizing the home screen..... 12
 - Understanding the status of the indicator light..... 12
 - Selecting paper..... 13

- Set up, install, and configure..... 18**
 - Selecting a location for the printer..... 18
 - Attaching cables..... 19
 - Installing optional trays..... 19
 - Setting up and using the home screen applications..... 20
 - Loading paper and specialty media..... 22
 - Installing and updating software, drivers, and firmware..... 26
 - Networking.....28
 - Configuring the SMTP server..... 31
 - Printing the Menu Settings Page..... 31

- Secure the printer.....32**
 - Erasing printer memory..... 32
 - Restoring factory default settings..... 32
 - Statement of Volatility..... 32

- Print..... 33**
 - Printing from a computer..... 33
 - Printing from a mobile device..... 33
 - Configuring confidential jobs..... 35
 - Printing confidential and other held jobs..... 35
 - Printing from a Cloud Connector profile..... 36
 - Printing a font sample list..... 36

Placing separator sheets between copies.....37

Canceling a print job.....37

Adjusting toner darkness.....37

Use printer menus..... 38

Menu map.....38

Device.....38

Print.....48

Paper.....54

Network/Ports.....56

Security.....68

Cloud Connector.....72

Reports.....72

Troubleshooting.....73

Maintain the printer..... 74

Checking the status of parts and supplies.....74

Configuring supply notifications.....74

Setting up e-mail alerts.....74

Viewing reports.....75

Ordering parts and supplies.....75

Replacing parts and supplies.....78

Cleaning the printer.....87

Saving energy and paper.....87

Moving the printer to another location.....88

Shipping the printer.....89

Troubleshoot a problem..... 90

The printer is not responding.....90

Network connection problems.....91

Issues with supplies.....92

Clearing jams.....93

Paper feed problems.....104

Printing problems.....107

Color quality problems.....136

Contacting customer support.....139

Recycle and dispose..... 140
 Recycling Lexmark products.....140
 Recycling Lexmark packaging.....140

Notices..... 141

Index..... 153

Safety information

Conventions

Note: A *note* identifies information that could help you.

Warning: A *warning* identifies something that could damage the product hardware or software.

CAUTION: A *caution* indicates a potentially hazardous situation that could injure you.

Different types of caution statements include:



CAUTION—POTENTIAL INJURY: Indicates a risk of injury.



CAUTION—SHOCK HAZARD: Indicates a risk of electrical shock.



CAUTION—HOT SURFACE: Indicates a risk of burn if touched.



CAUTION—TIPPING HAZARD: Indicates a crush hazard.



CAUTION—PINCH HAZARD: Indicates a risk of being caught between moving parts.

Product statements



CAUTION—POTENTIAL INJURY: To avoid the risk of fire or electrical shock, connect the power cord to an appropriately rated and properly grounded electrical outlet that is near the product and easily accessible.



CAUTION—POTENTIAL INJURY: To avoid the risk of fire or electrical shock, use only the power cord provided with this product or the manufacturer's authorized replacement.



CAUTION—POTENTIAL INJURY: Do not use this product with extension cords, multioutlet power strips, multioutlet extenders, or UPS devices. The power capacity of these types of accessories can be easily overloaded by a laser printer and may result in a risk of fire, property damage, or poor printer performance.



CAUTION—POTENTIAL INJURY: Only a Lexmark Inline Surge Protector that is properly connected between the printer and the power cord provided with the printer may be used with this product. The use of non-Lexmark surge protection devices may result in a risk of fire, property damage, or poor printer performance.











CAUTION—SHOCK HAZARD: To avoid the risk of electrical shock, do not place or use this product near water or wet locations.



CAUTION—SHOCK HAZARD: To avoid the risk of electrical shock, do not set up this product or make any electrical or cabling connections, such as the power cord, fax feature, or telephone, during a lightning storm.



CAUTION—POTENTIAL INJURY: Do not cut, twist, bind, crush, or place heavy objects on the power cord. Do not subject the power cord to abrasion or stress. Do not pinch the power cord between objects such as furniture and walls. If any of these things happen, a risk of fire or electrical shock results. Inspect the power cord regularly for signs of such problems. Remove the power cord from the electrical outlet before inspecting it.

-  **CAUTION—SHOCK HAZARD:** To avoid the risk of electrical shock, make sure that all external connections (such as Ethernet and telephone system connections) are properly installed in their marked plug-in ports.
-  **CAUTION—SHOCK HAZARD:** To avoid the risk of electrical shock, if you are accessing the controller board or installing optional hardware or memory devices sometime after setting up the printer, then turn the printer off, and unplug the power cord from the electrical outlet before continuing. If you have any other devices attached to the printer, then turn them off as well, and unplug any cables going into the printer.
-  **CAUTION—SHOCK HAZARD:** To avoid the risk of electrical shock when cleaning the exterior of the printer, unplug the power cord from the electrical outlet and disconnect all cables from the printer before proceeding.
-  **CAUTION—POTENTIAL INJURY:** If the printer weight is greater than 20 kg (44 lb), then it may require two or more people to lift it safely.
-  **CAUTION—POTENTIAL INJURY:** When moving the printer, follow these guidelines to avoid personal injury or printer damage:
- Make sure that all doors and trays are closed.
 - Turn off the printer, and then unplug the power cord from the electrical outlet.
 - Disconnect all cords and cables from the printer.
 - If the printer has separate floor-standing optional trays or output options attached to it, then disconnect them before moving the printer.
 - If the printer has a caster base, then carefully roll it to the new location. Use caution when passing over thresholds and breaks in flooring.
 - If the printer does not have a caster base but is configured with optional trays or output options, then remove the output options and lift the printer off the trays. Do not try to lift the printer and any options at the same time.
 - Always use the handholds on the printer to lift it.
 - Any cart used to move the printer must have a surface able to support the full footprint of the printer.
 - Any cart used to move the hardware options must have a surface able to support the dimensions of the options.
 - Keep the printer in an upright position.
 - Avoid severe jarring movements.
 - Make sure that your fingers are not under the printer when you set it down.
 - Make sure that there is adequate clearance around the printer.
-  **CAUTION—TIPPING HAZARD:** Installing one or more options on your printer or MFP may require a caster base, furniture, or other feature to prevent instability causing possible injury. For more information on supported configurations, see www.lexmark.com/multifunctionprinters.
-  **CAUTION—TIPPING HAZARD:** To reduce the risk of equipment instability, load each tray separately. Keep all other trays closed until needed.
-  **CAUTION—HOT SURFACE:** The inside of the printer might be hot. To reduce the risk of injury from a hot component, allow the surface to cool before touching it.
-  **CAUTION—PINCH HAZARD:** To avoid the risk of a pinch injury, use caution in areas marked with this label. Pinch injuries may occur around moving parts, such as gears, doors, trays, and covers.

 **CAUTION—POTENTIAL INJURY:** This product uses a laser. Use of controls or adjustments or performance of procedures other than those specified in the *User's Guide* may result in hazardous radiation exposure.

This product is designed, tested, and approved to meet strict global safety standards with the use of specific manufacturer's components. The safety features of some parts may not always be obvious. The manufacturer is not responsible for the use of other replacement parts.

Refer service or repairs, other than those described in the user documentation, to a service representative.

This product uses a printing process that heats the print media, and the heat may cause the media to release emissions. You must understand the section in your operating instructions that discusses the guidelines for selecting print media to avoid the possibility of harmful emissions.

This product may produce small amounts of ozone during normal operation, and may be equipped with a filter designed to limit ozone concentrations to levels well below the recommended exposure limits. To avoid high ozone concentration levels during extensive usage, install this product in a well-ventilated area and replace the ozone and exhaust filters if instructed to do so in the product maintenance instructions. If there are no references to filters in the product maintenance instructions, then there are no filters requiring replacement for this product.

SAVE THESE INSTRUCTIONS.

Learn about the printer

Finding information about the printer

What are you looking for?	Find it here
Initial setup instructions: <ul style="list-style-type: none"> • Connecting the printer • Installing the printer software 	See the setup documentation that came with the printer or go to http://support.lexmark.com .
More setup and instructions for using the printer: <ul style="list-style-type: none"> • Selecting and storing paper and specialty media • Loading paper • Configuring printer settings • Viewing and printing documents and photos • Setting up and using the printer software • Configuring the printer on a network • Caring for and maintaining the printer • Troubleshooting and solving problems 	<i>Information Center</i> —Go to http://infoserve.lexmark.com . Product videos—Go to http://infoserve.lexmark.com/idv/ .
Help using the printer software	Help for Microsoft Windows or Macintosh operating systems—Open a printer software program or application, and then click Help . Click  to view context-sensitive information. Notes: <ul style="list-style-type: none"> • Help is automatically installed with the printer software. • Depending on the operating system, the printer software is located in the printer program folder or on the desktop.

What are you looking for?	Find it here
<p>The latest supplemental information, updates, and customer support:</p> <ul style="list-style-type: none"> • Documentation • Driver downloads • Live chat support • E-mail support • Voice support 	<p>Go to http://support.lexmark.com.</p> <p>Note: Select your country or region, and then select your product to view the appropriate support site.</p> <p>Support contact information for your country or region can be found on the website or on the printed warranty that came with the printer.</p> <p>Have the following information ready when you contact customer support:</p> <ul style="list-style-type: none"> • Place and date of purchase • Machine type and serial number <div data-bbox="945 743 1448 1050" data-label="Image"> </div>
<ul style="list-style-type: none"> • Safety information • Regulatory information • Warranty information • Environmental information 	<p>Warranty information varies by country or region:</p> <ul style="list-style-type: none"> • In the U.S.—See the Statement of Limited Warranty included with the printer, or go to http://support.lexmark.com. • In other countries and regions—See the printed warranty that came with the printer. <p><i>Product Information Guide</i>—See the documentation that came with the printer or go to http://support.lexmark.com.</p>

Printer configurations

Lexmark CS331, Lexmark C3224, Lexmark C3326 printers



1	Control panel
2	Standard bin
3	Manual feeder
4	250-sheet tray

Lexmark CS431, Lexmark C3426 printers



1	Control panel
2	Standard bin
3	Manual feeder
4	Standard 250-sheet tray
5	Optional 250-sheet tray Note: Supported only in some printer models.

Using the control panel

Lexmark CS331, Lexmark C3224, Lexmark C3326 printers

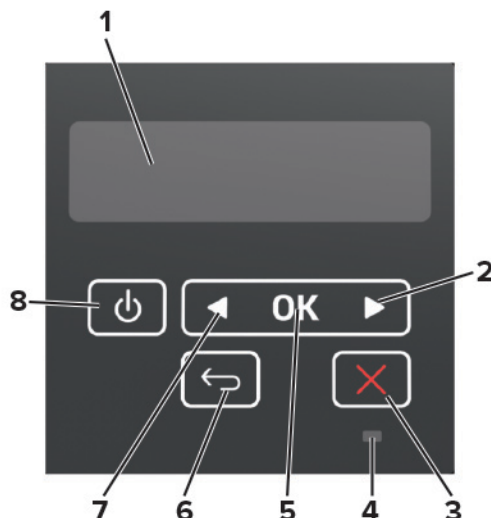

	Control panel part	Function
1	Display	<ul style="list-style-type: none"> View printer messages and supply status. Set up and operate the printer.
2	Right arrow button	<ul style="list-style-type: none"> Scroll through menus or move between screens and menu options. Increase the numeric value of a setting.
3	Stop or Cancel button	Stop the current job.
4	Indicator light	Check the status of the printer.
5	Select button	<ul style="list-style-type: none"> Select a menu option. Save the changes in a setting.
6	Back button	Return to the previous screen.
7	Left arrow button	<ul style="list-style-type: none"> Scroll through menus or move between screens and menu options. Decrease the numeric value of a setting.
8	Power button	Turn on or turn off the printer. Note: To turn off the printer, press and hold the power button for five seconds.

Lexmark CS431, Lexmark C3426 printers

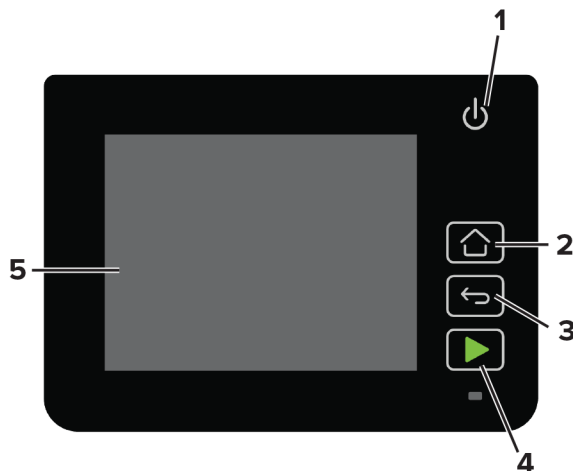

	Control panel part	Function
1	Power button	Turn on or turn off the printer. Note: To turn off the printer, press and hold the power button for five seconds.
2	Home button	Go to the home screen.
3	Back button	Return to the previous screen.
4	Start button	Start a job.
5	Indicator light	Check the status of the printer.
6	Display	<ul style="list-style-type: none"> View printer messages and supply status. Set up and operate the printer.

Customizing the home screen

This feature is available only in some printer models.

- 1 From the control panel, touch **Settings** > **Device** > **Visible Home Screen Icons**.
- 2 Select the icons that you want to appear on the home screen.
- 3 Apply the changes.

Understanding the status of the indicator light

Indicator light	Printer status
Off	The printer is off.
Blue	The printer is on or ready.
Blinking blue	The printer is processing data.
Blinking red	The printer requires user intervention.
Amber	The printer is in Sleep mode.

Selecting paper

Paper guidelines

Use the appropriate paper to prevent jams and help ensure trouble-free printing.

- Always use new, undamaged paper.
- Before loading paper, know the recommended printable side of the paper. This information is usually indicated on the paper package.
- Do not use paper that has been cut or trimmed by hand.
- Do not mix paper sizes, types, or weights in the same tray; mixing results in jams.
- Do not use coated papers unless they are specifically designed for electrophotographic printing.

Paper characteristics

The following paper characteristics affect print quality and reliability. Consider these factors before printing on them.

Weight

The trays can feed paper weights from 60 to 176 g/m² (16 to 47 lb) grain long paper. Paper lighter than 60 g/m² (16 lb) may not be stiff enough to feed properly, and may cause jams.

Curl

Curl is the tendency for paper to curl at its edges. Excessive curl can cause paper feeding problems. Curl can occur after the paper passes through the printer, where it is exposed to high temperatures. Storing paper unwrapped in hot, humid, cold, or dry conditions can contribute to paper curling before printing and can cause feeding problems.

Smoothness

Paper smoothness directly affects print quality. If paper is too rough, toner cannot fuse to it properly. If paper is too smooth, it can cause paper feeding or print quality issues. We recommend the use of paper with 50 Sheffield points.

Moisture content

The amount of moisture in paper affects both print quality and the printer ability to feed the paper correctly. Leave paper in its original wrapper until you use it. Exposure of paper to moisture changes can degrade its performance.

Store paper in its original wrapper in the same environment as the printer for 24 to 48 hours before printing. Extend the time several days if the storage or transportation environment is very different from the printer environment. Thick paper may also require a longer conditioning period.

Grain direction

Grain refers to the alignment of the paper fibers in a sheet of paper. Grain is either *grain long*, running the length of the paper, or *grain short*, running the width of the paper.

For 60–176 g/m² (16–47-lb) paper, grain long paper is recommended.

Fiber content

Most high-quality xerographic paper is made from 100 percent chemically treated pulped wood. This content provides the paper with a high degree of stability, resulting in fewer paper feeding problems and better print quality. Paper containing fibers such as cotton can negatively affect paper handling.

Unacceptable paper

The following paper types are not recommended for use with the printer:

- Chemically treated papers used to make copies without carbon paper, also known as carbonless papers, carbonless copy paper (CCP), or no carbon required (NCR) paper
- Preprinted papers with chemicals that may contaminate the printer
- Preprinted papers that can be affected by the temperature in the printer fuser
- Preprinted papers that require a registration (the precise print location on the page) greater than ± 2.3 mm (± 0.9 in.), such as optical character recognition (OCR) forms

In some cases, registration can be adjusted with a software application to successfully print on these forms.

- Coated papers (erasable bond), synthetic papers, thermal papers
- Rough-edged, rough or heavily textured surface papers, or curled papers
- Recycled papers that fail EN12281:2002 (European)
- Paper weighing less than 60 g/m^2 (16 lb)
- Multiple-part forms or documents

Storing paper

Use these paper storage guidelines to help avoid jams and uneven print quality:

- Store paper in its original wrapper in the same environment as the printer for 24 to 48 hours before printing.
- Extend the time several days if the storage or transportation environment is very different from the printer environment. Thick paper may also require a longer conditioning period.
- For best results, store paper where the temperature is 21°C (70°F) and the relative humidity is 40 percent.
- Most label manufacturers recommend printing in a temperature range of $18\text{--}24^\circ\text{C}$ ($65\text{--}75^\circ\text{F}$) with relative humidity between 40 and 60 percent.
- Store paper in cartons, on a pallet or shelf, rather than on the floor.
- Store individual packages on a flat surface.
- Do not store anything on top of individual paper packages.
- Take paper out of the carton or wrapper only when you are ready to load it in the printer. The carton and wrapper help keep the paper clean, dry, and flat.

Selecting preprinted forms and letterhead

- Use grain long paper.
- Use only forms and letterhead printed using an offset lithographic or engraved printing process.
- Avoid paper with rough or heavily textured surfaces.
- Use inks that are not affected by the resin in toner. Inks that are oxidation-set or oil-based generally meet these requirements; latex inks might not.

- Print samples on preprinted forms and letterheads considered for use before buying large quantities. This action determines whether the ink in the preprinted form or letterhead affects print quality.
- When in doubt, contact your paper supplier.
- When printing on letterhead, load the paper in the proper orientation for your printer. For more information, see the *Paper and Specialty Media Guide*.

Supported paper sizes

Paper size	Standard or optional 250-sheet tray	Manual feeder	Two-sided printing
A4 210 x 297 mm (8.27 x 11.7 in.)	✓	✓	✓
A5¹ 148 x 210 mm (5.83 x 8.27 in.)	✓	✓	X
A6 105 x 148 mm (4.13 x 5.83 in.)	✓	✓	X
JIS B5 182 x 257 mm (7.17 x 10.1 in.)	✓	✓	X
Oficio (Mexico) 215.9 x 340.4 mm (8.5 x 13.4 in.)	✓	✓	✓
Hagaki 100 x 148 mm (3.94 x 5.83 in.)	✓	✓	X
Statement 139.7 x 215.9 mm (5.5 x 8.5 in.)	✓	✓	X
Executive 184.2 x 266.7 mm (7.25 x 10.5 in.)	✓	✓	X
Letter 215.9 x 279.4 mm (8.5 x 11 in.)	✓	✓	✓
Legal 215.9 x 355.6 mm (8.5 x 14 in.)	✓	✓	✓
Folio 215.9 x 330.2 mm (8.5 x 13 in.)	✓	✓	✓
Universal^{2,3} 98.4 x 148 mm (3.86 x 5.83 in.) to 215.9 x 355.6 mm (8.5 x 14 in.)	✓	✓	✓

¹ The default support is long-edge feed. When running on short-edge feed, A5 is treated as narrow paper.

² When Universal is selected, the page is formatted for 215.90 x 355.60 mm (8.5 x 14 in.) unless specified by the software application.

³ Load narrow paper with the short edge entering the printer first.

⁴ The standard 250-sheet tray supports up to 5 envelopes at a time. The optional 250-sheet tray supports up to 40 envelopes at a time.

Paper size	Standard or optional 250-sheet tray	Manual feeder	Two-sided printing
Universal ^{2,3} 25.4 x 25.4 mm (1 x 1 in.) to 215.9 x 297 mm (8.5 x 11.69 in.)	X	X	X
Universal ^{2,3} 105 x 148 mm (4.13 x 5.83 in.) to 215.9 x 355.6 mm (8.5 x 14 in.)	X	X	X
7 3/4 Envelope 98.4 x 190.5 mm (3.875 x 7.5 in.)	✓ ⁴	✓	X
9 Envelope 98.4 x 225.4 mm (3.875 x 8.9 in.)	✓ ⁴	✓	X
10 Envelope 104.8 x 241.3 mm (4.12 x 9.5 in.)	✓ ⁴	✓	X
DL Envelope 110 x 220 mm (4.33 x 8.66 in.)	✓ ⁴	✓	X
C5 Envelope 162 x 229 mm (6.38 x 9.01 in.)	✓ ⁴	✓	X
B5 Envelope 176 x 250 mm (6.93 x 9.84 in.)	✓ ⁴	✓	X
Other Envelope 98.4 x 162 mm (3.87 x 6.38 in.) to 176 x 250 mm (6.93 x 9.84 in.)	✓ ⁴	✓	X

¹ The default support is long-edge feed. When running on short-edge feed, A5 is treated as narrow paper.

² When Universal is selected, the page is formatted for 215.90 x 355.60 mm (8.5 x 14 in.) unless specified by the software application.

³ Load narrow paper with the short edge entering the printer first.

⁴ The standard 250-sheet tray supports up to 5 envelopes at a time. The optional 250-sheet tray supports up to 40 envelopes at a time.

Supported paper types

Notes:

- Labels, envelopes, and card stock always print at reduced speed.
- Labels are supported for occasional use and must be tested for acceptability.

Paper type	Standard or optional 250-sheet tray	Manual feeder	Two-sided printing
Plain paper	✓	✓	✓
Card stock	✓	✓	X

Paper type	Standard or optional 250-sheet tray	Manual feeder	Two-sided printing
Labels	✓	✓	X
Envelopes	✓	✓	X

Supported paper weights

Paper type and weight	Standard or optional 250-sheet tray	Manual feeder	Two-sided printing
Light paper 60–74.9 g/m ² grain long (16–19.9-lb bond)	✓	✓	✓
Plain paper 75–90.3 g/m ² grain long (20–24-lb bond)	✓	✓	✓
Heavy paper 90.3–100 g/m ² grain long (24.1–26-lb bond)	✓	✓	✓
Card stock 105.1–162 g/m ² grain long (28.1–43-lb bond)	✓	✓	X
Card stock 105.1–200 g/m ² grain long (28.1–53-lb bond)	X	✓	X
Paper labels 131 g/m ² (35-lb bond)	✓	✓	X
Envelopes 60–90 g/m ² (16–24-lb bond)	✓	✓	X

Set up, install, and configure

Selecting a location for the printer

- Leave enough room to open trays, covers, and doors and to install hardware options.
- Set up the printer near an electrical outlet.

⚠ CAUTION—POTENTIAL INJURY: To avoid the risk of fire or electrical shock, connect the power cord to an appropriately rated and properly grounded electrical outlet that is near the product and easily accessible.

⚠ CAUTION—SHOCK HAZARD: To avoid the risk of electrical shock, do not place or use this product near water or wet locations.

- Make sure that airflow in the room meets the latest revision of the ASHRAE 62 standard or the CEN Technical Committee 156 standard.
- Provide a flat, sturdy, and stable surface.
- Keep the printer:
 - Clean, dry, and free of dust
 - Away from stray staples and paper clips
 - Away from the direct airflow of air conditioners, heaters, or ventilators
 - Free from direct sunlight and humidity extremes
- Observe the temperature range.

Operating temperature	10 to 32.2°C (50 to 90°F)
-----------------------	---------------------------

- Allow the following recommended amount of space around the printer for proper ventilation:

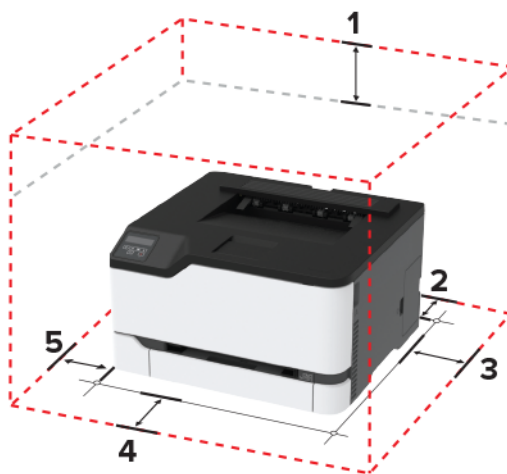

1	Top	101 mm (4 in.)
2	Rear	102 mm (4 in.)
3	Right side	76 mm (3 in.)
4	Front	76 mm (3 in.)
5	Left side	76 mm (3 in.)

Attaching cables

⚠ CAUTION—SHOCK HAZARD: To avoid the risk of electrical shock, do not set up this product or make any electrical or cabling connections, such as the power cord, fax feature, or telephone, during a lightning storm.

⚠ CAUTION—POTENTIAL INJURY: To avoid the risk of fire or electrical shock, connect the power cord to an appropriately rated and properly grounded electrical outlet that is near the product and easily accessible.

⚠ CAUTION—POTENTIAL INJURY: To avoid the risk of fire or electrical shock, use only the power cord provided with this product or the manufacturer's authorized replacement.

Warning—Potential Damage: To avoid loss of data or printer malfunction, do not touch the USB cable, any wireless network adapter, or the printer in the areas shown while actively printing.

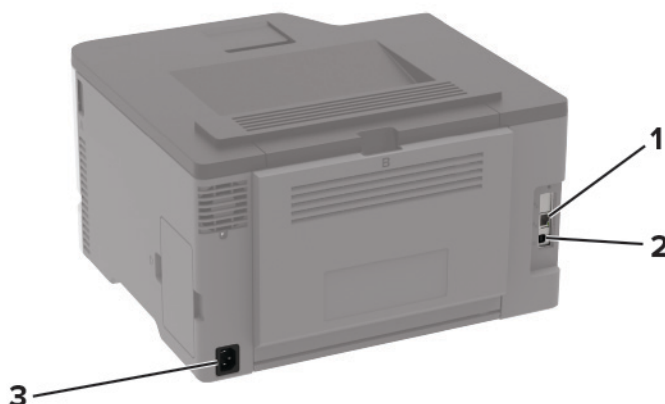

	Printer port	Function
1	Ethernet port	Connect the printer to a network.
2	USB printer port	Connect the printer to a computer.
3	Power cord socket	Connect the printer to an electrical outlet.

Installing optional trays

⚠ CAUTION—SHOCK HAZARD: To avoid the risk of electrical shock, if you are accessing the controller board or installing optional hardware or memory devices sometime after setting up the printer, then turn the printer off, and unplug the power cord from the electrical outlet before continuing. If you have any other devices attached to the printer, then turn them off as well, and unplug any cables going into the printer.

- 1 Turn off the printer.
- 2 Unplug the power cord from the electrical outlet, and then from the printer.
- 3 Unpack the optional tray, and then remove all packing material.

- 4 Align the printer with the optional tray, and then lower the printer into place.

 **CAUTION—POTENTIAL INJURY:** If the printer weight is greater than 20 kg (44 lb), then it may require two or more people to lift it safely.



- 5 Connect the power cord to the printer, and then to the electrical outlet.

 **CAUTION—POTENTIAL INJURY:** To avoid the risk of fire or electrical shock, connect the power cord to an appropriately rated and properly grounded electrical outlet that is near the product and easily accessible.

- 6 Turn on the printer.

Add the tray in the print driver to make it available for print jobs. For more information, see [“Adding available options in the print driver” on page 27](#).

Setting up and using the home screen applications

This feature is available only in some printer models.

Creating a Cloud Connector profile

- 1 From the home screen, touch **Cloud Connector**.
- 2 Select a cloud service provider.
- 3 Touch **Create** or .
- 4 Type a unique profile name.

Note: We recommend creating a PIN to protect the profile.

- 5 Touch **OK**, and then take note of the authorization code.

Note: The authorization code is valid only for 24 hours.

- 6 Open a web browser, and then go to <https://lexmark.cloud-connect.co>.
- 7 Click **Next**, and then accept the Terms of Use.
- 8 Enter the authorization code, and then click **Connect**.
- 9 Log in to your cloud service provider account.
- 10 Grant permissions.

Note: To complete the authorization process, open the profile within 72 hours.

Managing bookmarks

Creating bookmarks

Use bookmarks to print frequently accessed documents that are stored in servers or on the web.

- 1 Open a web browser, and then type the printer IP address in the address field.

Notes:

- View the printer IP address on the printer home screen. The IP address appears as four sets of numbers separated by periods, such as 123.123.123.123.
- If you are using a proxy server, then temporarily disable it to load the web page correctly.

- 2 Click **Bookmarks > Add Bookmark**, and then type a bookmark name.

- 3 Select an Address protocol type, and then do one of the following:

- For HTTP and HTTPS, type the URL that you want to bookmark.
- For HTTPS, make sure to use the host name instead of the IP address. For example, type **myWebsite.com/sample.pdf** instead of typing **123.123.123.123/sample.pdf**. Make sure that the host name also matches the Common Name (CN) value in the server certificate. For more information on obtaining the CN value in the server certificate, see the help information for your web browser.
- For FTP, type the FTP address. For example, **myServer/myDirectory**. Enter the FTP port. Port 21 is the default port for sending commands.
- For SMB, type the network folder address. For example, **myServer/myShare/myFile.pdf**. Type the network domain name.
- If necessary, select the Authentication type for FTP and SMB.

To limit access to the bookmark, enter a PIN.

Note: The application supports the following file types: PDF, JPEG, TIFF, and HTML-based web pages. Other file types such as DOCX and XLXS are supported in some printer models.

- 4 Click **Save**.

Creating folders

- 1 Open a web browser, and then type the printer IP address in the address field.

Notes:

- View the printer IP address on the printer home screen. The IP address appears as four sets of numbers separated by periods, such as 123.123.123.123.

- If you are using a proxy server, then temporarily disable it to load the web page correctly.

2 Click **Bookmarks > Add Folder**, and then type a folder name.

Note: To limit access to the folder, enter a PIN.

3 Click **Save**.

Note: You can create folders or bookmarks inside a folder. To create a bookmark, see [“Creating bookmarks” on page 21](#).

Loading paper and specialty media

Setting the paper size and type

1 From the control panel, navigate to:

Settings > Paper > Tray Configuration > Paper Size/Type > select a paper source

For non-touch-screen printer models, press  to navigate through the settings.

2 Set the paper size and type.

Configuring Universal paper settings

1 From the control panel, navigate to:

Settings > Paper > Media Configuration > Universal Setup

For non-touch-screen printer models, press  to navigate through the settings.

2 Configure the settings.

Loading trays

 **CAUTION—TIPPING HAZARD:** To reduce the risk of equipment instability, load each tray separately. Keep all other trays closed until needed.

1 Remove the tray.

Note: To avoid paper jams, do not remove trays while the printer is busy.



2 Flex, fan, and align the paper edges before loading.

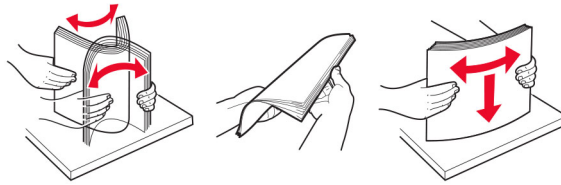

3 Load the paper stack with the printable side faceup.



Notes:

- Load letterhead faceup with the header toward the back of the tray for one-sided printing.
- Load letterhead facedown with the header toward the front of the tray for two-sided printing.
- Do not slide paper into the tray.
- To avoid paper jams, make sure that the stack height is below the maximum paper fill indicator.

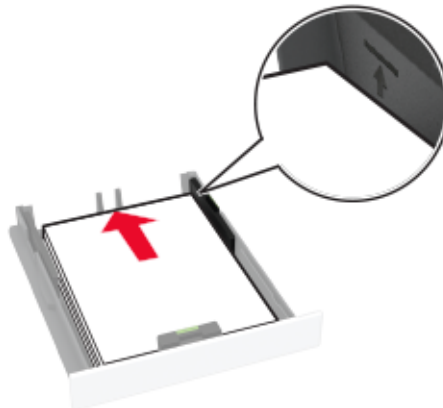

- 4 Adjust the guides to match the size of the paper that you are loading.

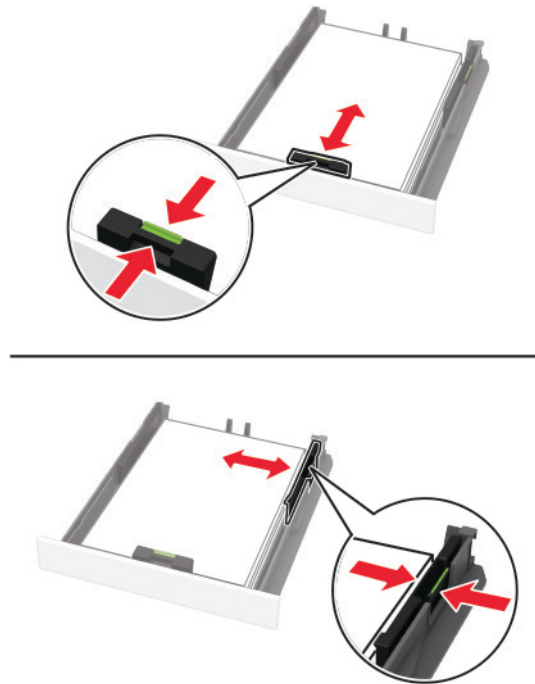

- 5 Insert the tray.

If necessary, set the paper size and paper type from the control panel to match the paper loaded.

Loading the manual feeder

- 1 Adjust the guide to match the size of the paper that you are loading.

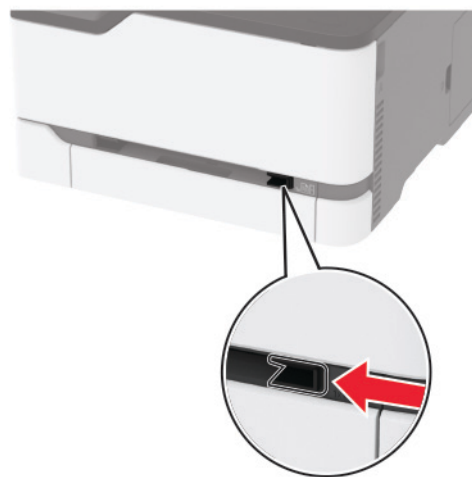

2 Load a sheet of paper with the printable side faceup.

- Load letterhead with the printable side faceup and the top edge entering the printer first for one-sided printing.

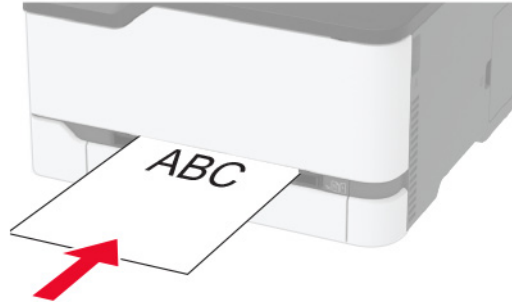

- Load letterhead with the printable side facedown and the top edge entering the printer last for two-sided printing.

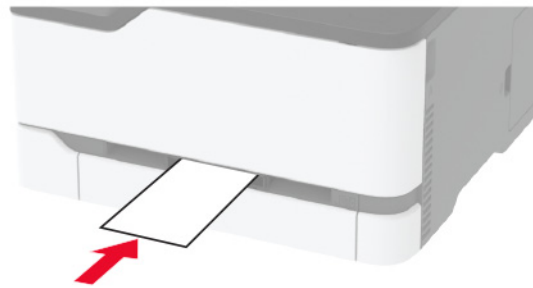

- Load envelope with the flap side down and against the right side of the paper guide.

**3** Feed the paper until its leading edge gets pulled in.**Notes:**

- To avoid paper jams, do not force paper into the manual feeder.
- Before loading another sheet, wait for a message to appear on the display.

Linking trays

- 1 From the control panel, navigate to:
Settings > Paper > Tray Configuration

For non-touch-screen printer models, press  to navigate through the settings.

- 2 Select a paper source.
- 3 Set the same paper size and paper type for the trays that you are linking.
- 4 From the control panel, navigate to:
Settings > Device > Maintenance > Config Menu > Tray Configuration
- 5 Set Tray Linking to **Automatic**.

Note: To unlink trays, make sure that no trays have the same paper size and paper type settings.

Warning—Potential Damage: The temperature of the fuser varies according to the specified paper type. To avoid printing issues, match the paper type setting in the printer with the paper loaded in the tray.

Installing and updating software, drivers, and firmware

Installing the printer software

Notes:

- The print driver is included in the software installer package.
 - For Macintosh computers with macOS version 10.7 or later, you do not need to install the driver to print on an AirPrint-certified printer.
- 1 Obtain a copy of the software installer package.
 - From the software CD that came with your printer.
 - Go to <http://support.lexmark.com>, and then select your printer and operating system.
 - 2 Run the installer, and then follow the instructions on the computer screen.

Updating firmware

Some applications require a minimum device firmware level to operate correctly.

For more information on updating the device firmware, contact your Lexmark representative.

- 1 Open a web browser, and then type the printer IP address in the address field.

Notes:

- View the printer IP address on the printer home screen. The IP address appears as four sets of numbers separated by periods, such as 123.123.123.123.
- If you are using a proxy server, then temporarily disable it to load the web page correctly.

- 2 Click **Settings > Device > Update Firmware**.

- 3 Browse to the flash file.
- 4 Click **Upload**.

Exporting or importing a configuration file

You can export the configuration settings of your printer into a text file, and then import the file to apply the settings to other printers.

- 1 Open a web browser, and then type the printer IP address in the address field.

Notes:

- View the printer IP address on the printer home screen. The IP address appears as four sets of numbers separated by periods, such as 123.123.123.123.
- If you are using a proxy server, then temporarily disable it to load the web page correctly.

- 2 From the Embedded Web Server, click **Export Configuration** or **Import Configuration**.
- 3 Follow the instructions on the screen.
- 4 If the printer supports applications, then do the following:
 - a Click **Apps** > select the application > **Configure**.
 - b Click **Export** or **Import**.

Adding available options in the print driver

For Windows users

- 1 Open the printers folder.
- 2 Select the printer you want to update, and then do either of the following:
 - For Windows 7 or later, select **Printer properties**.
 - For earlier versions, select **Properties**.
- 3 Navigate to the Configuration tab, and then select **Update Now - Ask Printer**.
- 4 Apply the changes.

For Macintosh users

- 1 From System Preferences in the Apple menu, navigate to your printer, and then select **Options & Supplies**.
- 2 Navigate to the list of hardware options, and then add any installed options.
- 3 Apply the changes.

Networking

Connecting the printer to a Wi-Fi network

Make sure that Active Adapter is set to Auto. From the control panel, navigate to:

Settings > Network/Ports > Network Overview > Active Adapter

For non-touch-screen printer models, press  to navigate through the settings.

Using the control panel

1 From the control panel, navigate to:

Settings > Network/Ports > Wireless > Setup On Printer Panel

For non-touch-screen printer models, press  to navigate through the settings.

2 Select a Wi-Fi network, and then type the network password.

Note: For Wi-Fi-network-ready printer models, a prompt to set up the Wi-Fi network appears during initial setup.

Using Lexmark Mobile Assistant

1 Depending on your mobile device, download the Lexmark Mobile Assistant application from either the Google Play™ store or App Store online store.

2 Depending on your printer model, do one of the following:

- From the home screen, touch **Settings > Network/Ports > Wireless > Setup Using Mobile App > Printer ID**.
- From the control panel, navigate to:

 > **Network/Ports** >  > **Wireless** >  > **Setup Using Mobile App** > 

Follow the instructions on the display to view the printer ID.

Note: The printer ID is the printer wireless network SSID.

3 From your mobile device, launch the application, and then accept the Terms of Use.

Note: If necessary, grant permissions.

4 Tap **Connect to Printer > Go to Wi-Fi Settings**.

5 Connect your mobile device to the printer wireless network.

6 Return to the application, and then tap **Setup Wi-Fi Connection**

7 Select a Wi-Fi network, and then type the network password.

8 Tap **Done**.

Connecting the printer to a wireless network using Wi-Fi Protected Setup (WPS)

Before you begin, make sure that:

- The access point (wireless router) is WPS-certified or WPS-compatible. For more information, see the documentation that came with your access point.
- A wireless network adapter is installed in your printer. For more information, see the instructions that came with the adapter.
- Active Adapter is set to Auto. From the control panel, navigate to:
Settings > Network/Ports > Network Overview > Active Adapter

For non-touch-screen printer models, press  to navigate through the settings.

Using the Push Button method

1 From the control panel, navigate to:

Settings > Network/Ports > Wireless > Wi-Fi Protected Setup > Start Push Button Method

For non-touch-screen printer models, press  to navigate through the settings.

2 Follow the instructions on the display.

Using the personal identification number (PIN) method

1 From the control panel, navigate to:

Settings > Network/Ports > Wireless > Wi-Fi Protected Setup > Start PIN Method

For non-touch-screen printer models, press  to navigate through the settings.

2 Copy the eight-digit WPS PIN.

3 Open a web browser, and then type the IP address of your access point in the address field.

Notes:

- To know the IP address, see the documentation that came with your access point.
- If you are using a proxy server, then temporarily disable it to load the web page correctly.

4 Access the WPS settings. For more information, see the documentation that came with your access point.

5 Enter the eight-digit PIN, and then save the changes.

Connecting a mobile device to the printer

Before connecting your mobile device, make sure to do the following:

- Enable Wi-Fi Direct® in the printer. From the control panel, navigate to: **Settings > Network/Ports > Wireless > Enable Wi-Fi Direct**.
- Show the preshared key (PSK) on the Network Setup Page. From the control panel, navigate to: **Settings > Network/Ports > Wi-Fi Direct > Show PSK on Setup Page**.
- Print the Network Setup Page. From the control panel, navigate to: **Settings > Reports > Network > Network Setup Page**.

For non-touch-screen printer models, press  to navigate through the settings.

Connecting using Wi-Fi Direct

- 1 From the mobile device, go to the settings menu.
- 2 Enable Wi-Fi, and then tap **Wi-Fi Direct**.
- 3 Select the printer SSID.
- 4 Confirm the connection on the printer control panel.

Connecting using Wi-Fi

- 1 From the mobile device, go to the settings menu.
- 2 Tap **Wi-Fi**, and then select the printer SSID.

Note: The string **DIRECT-xy** (where **x** and **y** are two random characters) is added before the SSID.

- 3 Enter the PSK.

Note: The PSK is the password.

Notes:

- You can change the SSID on the control panel. Navigate to: **Settings > Network/Ports > Wi-Fi Direct > SSID**.
- You can also change the PSK on the control panel. Navigate to: **Settings > Network/Ports > Wi-Fi Direct > Set PSK**.

Deactivating the Wi-Fi network

- 1 From the printer control panel, navigate to:
Settings > Network/Ports > Network Overview > Active Adapter > Standard Network

For non-touch-screen printer models, press  to navigate through the settings.

- 2 Follow the instructions on the display.

Checking the printer connectivity

- 1 Print the Network Setup Page.

From the control panel, navigate to:

Settings > Reports > Network > Network Setup Page

For non-touch-screen printer models, press  to navigate through the settings.

- 2 Check the first section of the page and confirm that the status is connected.

If the status is not connected, then the LAN drop may be inactive or the network cable may be unplugged or malfunctioning. Contact your administrator for assistance.

Configuring the SMTP server

Note: In some printer models, this setting can be configured only from the Embedded Web Server.

From the control panel

- 1 From the control panel, navigate to:
Settings > Device > Notifications > E-mail Alerts Setup > E-mail Setup
- 2 Configure the settings.

From the Embedded Web Server

- 1 Open a web browser, and then type the printer IP address in the address field.

Notes:

- View the printer IP address on the printer home screen. The IP address appears as four sets of numbers separated by periods, such as 123.123.123.123.
- If you are using a proxy server, then temporarily disable it to load the web page correctly.

- 2 Click **Settings > Device > Notifications > E-mail Alerts Setup**.
- 3 From the E-mail Setup section, configure the settings.
- 4 Click **Save**.

Printing the Menu Settings Page

From the control panel, navigate to:

Settings > Reports > Menu Settings Page

For non-touch-screen printer models, press  to navigate through the settings.

Secure the printer

Erasing printer memory

To erase volatile memory or buffered data, turn off the printer.

To erase non-volatile memory or individual settings, device and network settings, security settings, and embedded solutions, do the following:

- 1 From the control panel, navigate to:
Settings > Device > Maintenance > Out of Service Erase > Sanitize all information on nonvolatile memory

For non-touch-screen printer models, press  to navigate through the settings.

- 2 Select either **Start initial setup** or **Leave printer offline**.

Restoring factory default settings

- 1 From the control panel, navigate to:
Settings > Device > Restore Factory Defaults

For non-touch-screen printer models, press  to navigate through the settings.

- 2 Select **Restore all settings**.

Statement of Volatility

Your printer contains various types of memory that can store device and network settings, and user data.

Type of memory	Description
Volatile memory	Your printer uses standard <i>random access memory</i> (RAM) to temporarily buffer user data during simple print jobs.
Non-volatile memory	Your printer may use two forms of non-volatile memory: EEPROM and NAND (flash memory). Both types are used to store operating system, device settings, and network information.

Erase the content of any installed printer memory in the following circumstances:

- The printer is being decommissioned.
- The printer is being moved to a different department or location.
- The printer is being serviced by someone from outside your organization.
- The printer is being removed from your premises for service.
- The printer is being sold to another organization.

Print

Printing from a computer

Note: For labels, card stock, and envelopes, set the paper size and type in the printer before printing the document.

- 1 From the document that you are trying to print, open the Print dialog.
- 2 If necessary, adjust the settings.
- 3 Print the document.



Printing from a mobile device

Printing from a mobile device using Google Cloud Print

Google Cloud Print™ is a printing service that allows you to print to any Google Cloud Print-ready printer.

Before you begin, make sure that:

- The printer is registered to the Google Cloud Print server.
- The Cloud Print plugin is downloaded from the Google Play store and is enabled in the mobile device.

- 1 From your Android™ mobile device, open a document or select a document from your file manager.
- 2 Tap  > **Print**.
- 3 Select a printer, and then tap .

Printing from a mobile device using Lexmark Mobile Print

Lexmark™ Mobile Print allows you to send documents and images directly to a supported Lexmark printer.

- 1 Open the document, and then send or share the document to Lexmark Mobile Print.



Note: Some third-party applications may not support the send or share feature. For more information, see the documentation that came with the application.

- 2 Select a printer.
- 3 Print the document.

Printing from a mobile device using Mopria Print Service

Mopria® Print Service is a mobile printing solution for mobile devices running on Android version 5.0 or later. It allows you to print directly to any Mopria-certified printer.

Note: Make sure that you download the Mopria Print Service application from the Google Play store and enable it in the mobile device.

- 1 From your Android mobile device, launch a compatible application or select a document from your file manager.
- 2 Tap  > **Print**.
- 3 Select a printer, and then adjust the settings, if necessary.
- 4 Tap .

Printing from a mobile device using AirPrint

The AirPrint software feature is a mobile printing solution that allows you to print directly from Apple devices to an AirPrint-certified printer.

Notes:



- Make sure that the Apple device and the printer are connected to the same network. If the network has multiple wireless hubs, then make sure that both devices are connected to the same subnet.
- This application is supported only in some Apple devices.

- 1 From your mobile device, select a document from your file manager or launch a compatible application.
- 2 Tap  > **Print**.
- 3 Select a printer, and then adjust the settings, if necessary.
- 4 Print the document.

Printing from a mobile device using Wi-Fi Direct®

Wi-Fi Direct is a printing service that lets you print to any Wi-Fi Direct-ready printer.

Note: Make sure that the mobile device is connected to the printer wireless network. For more information, see [“Connecting a mobile device to the printer” on page 29](#).

- 1 From your mobile device, launch a compatible application or select a document from your file manager.
- 2 Depending on your mobile device, do one of the following:
 - Tap  > **Print**.
 - Tap  > **Print**.
 - Tap  > **Print**.
- 3 Select a printer, and then adjust the settings, if necessary.
- 4 Print the document.

Configuring confidential jobs

In some printer models, this setting can be configured only from the Embedded Web Server.

Using the control panel

- 1 From the home screen, touch:
Settings > Security > Confidential Print Setup
- 2 Configure the settings.

Using the Embedded Web Server

- 1 Open a web browser, and then type the printer IP address in the address field.

Notes:

- View the printer IP address on the home screen. The IP address appears as four sets of numbers separated by periods, such as 123.123.123.123.
- If you are using a proxy server, then temporarily disable it to load the web page correctly.

- 2 Click **Settings > Security > Confidential Print Setup**.
- 3 Configure the settings.

Printing confidential and other held jobs

For Windows users

- 1 With a document open, click **File > Print**.
- 2 Click **Properties, Preferences, Options, or Setup**.
- 3 Click **Print and Hold**.
- 4 Select **Use Print and Hold**, and then assign a user name.
- 5 Select the print job type (Confidential, Repeat, Reserve, or Verify).
If the print job is confidential, then enter a four-digit PIN.
- 6 Click **OK** or **Print**.
- 7 From the printer home screen, release the print job.
 - For confidential print jobs, navigate to:
Held jobs > select your user name > Confidential > enter the PIN > select the print job > configure the settings > Print
 - For other print jobs, navigate to:
Held jobs > select your user name > select the print job > configure the settings > Print

For Macintosh users

- 1 With a document open, choose **File > Print**.

If necessary, click the disclosure triangle to see more options.

- 2 From the print options or Copies & Pages menu, choose **Job Routing**.

- 3 Select the print job type (Confidential, Repeat, Reserve, or Verify).

If the print job is confidential, then assign a user name and a four-digit PIN.

- 4 Click **OK** or **Print**.

- 5 From the printer home screen, release the print job.

- For confidential print jobs, navigate to:

Held jobs > select your user name > **Confidential** > enter the PIN > select the print job > configure the settings > **Print**

- For other print jobs, navigate to:

Held jobs > select your user name > select the print job > configure the settings > **Print**

Printing from a Cloud Connector profile

- 1 From the home screen, touch **Cloud Connector**.

- 2 Select a cloud service provider, and then select a profile.

Note: For more information on creating a Cloud Connector profile, see [“Creating a Cloud Connector profile” on page 20](#).

- 3 Touch **Print**, and then select a file.

If necessary, change the settings.

Note: Make sure to select a supported file.

- 4 Print the document.

Printing a font sample list

- 1 From the control panel, navigate to:

Settings > Reports > Print > Print Fonts

For non-touch-screen printer models, press  to navigate through the settings.

- 2 Select a font sample.

Placing separator sheets between copies

1 From the home screen, navigate to:

Settings > Print > Layout > Separator Sheets > Between Copies

For non-touch-screen printer models, press  to navigate through the settings.

2 Print the document.

Canceling a print job

From the printer control panel

For touch-screen printer models, do the following:

1 From the home screen, touch **Cancel a job**.

2 Select a job to cancel.

For non-touch-screen printer models, press .

From the computer

1 Depending on the operating system, do either of the following:

- Open the printers folder, and then select your printer.
- From the System Preferences in the Apple menu, navigate to your printer.

2 Select the job to cancel.

Adjusting toner darkness

1 From the control panel, navigate to:

Settings > Print > Quality > Toner Darkness

For non-touch-screen printer models, press  to navigate through the settings.

2 Adjust the setting.

3 Apply the changes.

Use printer menus

Menu map

Device	<ul style="list-style-type: none"> • Preferences • Eco-Mode • Remote Operator Panel² • Notifications • Power Management 	<ul style="list-style-type: none"> • Information Sent to Lexmark • Restore Factory Defaults • Maintenance • Visible Home Screen Icons¹ • About this Printer
Print	<ul style="list-style-type: none"> • Layout • Setup • Quality 	<ul style="list-style-type: none"> • PostScript • PCL • Image
Paper	<ul style="list-style-type: none"> • Tray Configuration 	<ul style="list-style-type: none"> • Media Configuration
Network/Ports	<ul style="list-style-type: none"> • Network Overview • Wireless • Ethernet • TCP/IP • SNMP • IPSec • 802.1x 	<ul style="list-style-type: none"> • LPD Configuration • HTTP/FTP Settings • USB • Restrict external network access • Google Cloud Print • Wi-Fi Direct
Security ²	<ul style="list-style-type: none"> • Login Methods • Certificate Management • Login Restrictions 	<ul style="list-style-type: none"> • Confidential Print Setup • Erase Temporary Data Files • Miscellaneous
Cloud Connector ¹	Enable/Disable Connectors	
Reports	<ul style="list-style-type: none"> • Menu Settings Page • Device 	<ul style="list-style-type: none"> • Print • Network
Troubleshooting	Print Quality Test Pages	
¹ This menu is available only in some printer models.		
² In some printer models, this menu can be configured only from the Embedded Web Server.		

Device

Preferences

Menu item	Description
Display Language [List of languages]	Set the language of the text that appears on the display.
Note: An asterisk (*) next to a value indicates the factory default setting.	

Menu item	Description
Country/Region [List of countries or regions]	Identify the country or region where the printer is configured to operate.
Run initial setup No* Yes	Run the setup wizard.
Keyboard Keyboard Type [List of languages]	Select a language as a keyboard type. Notes: <ul style="list-style-type: none"> • All the Keyboard Type values may not appear or may require special hardware to appear. • This menu item appears only in some printer models.
Displayed information Display Text 1 (IP Address*) Display Text 2 (Date/Time*) Custom Text 1 Custom Text 2	Specify the information to appear on the home screen.
Date and Time Configure Current Date and Time Manually Set Date and Time Date Format (MM-DD-YYYY*) Time Format (12 hour A.M./P.M.*) Time Zone (GMT*)	Configure the printer date and time.
Date and Time Network Time Protocol Enable NTP (On*) NTP Server Enable Authentication (None*)	Configure the settings for Network Time Protocol (NTP). Notes: <ul style="list-style-type: none"> • Enable Authentication appears only in some printer models. • When Enable Authentication is set to MD5 key, Key ID and Password appear.
Paper Sizes U.S.* Metric	Specify the unit of measurement for paper sizes. Note: The country or region selected in the initial setup wizard determines the initial paper size setting.
Screen Brightness 20–100% (100*)	Adjust the brightness of the display. Note: This menu item appears only in some printer models.
Screen Timeout 10–300 (60*)	Set the idle time in seconds before the display shows the home screen or before the printer logs off a user account automatically.
Note: An asterisk (*) next to a value indicates the factory default setting.	

Eco-Mode

Menu item	Description
Print Sides 1-Sided* 2-Sided	Specify whether to print on one side or two sides of the paper.
Print Pages per Side Off* 2 pages per side 3 pages per side 4 pages per side 6 pages per side 9 pages per side 12 pages per side 16 pages per side	Print multiple page images on one side of a sheet of paper.
Print Toner Darkness Light Normal* Dark	Determine the lightness or darkness of text images.
Note: An asterisk (*) next to a value indicates the factory default setting.	

Remote Operator Panel

Menu item	Description
External VNC Connection Don't Allow* Allow	Connect an external Virtual Network Computing (VNC) client to the remote control panel.
Authentication Type None* Standard Authentication	Set the authentication type when accessing the VNC client server.
VNC Password	Specify the password to connect to the VNC client server. Note: This menu item appears only if Authentication Type is set to Standard Authentication.
Note: An asterisk (*) next to a value indicates the factory default setting.	

Notifications

Menu item	Description
Supplies Show Supply Estimates Show estimates* Do not show estimates	Show the estimated status of the supplies.
Supplies Custom Supply Notifications	Configure notification settings when the printer requires user intervention. Note: This menu item appears only in the Embedded Web Server.
E-mail Alerts Setup E-mail Setup Primary SMTP Gateway Primary SMTP Gateway Port (25*) Secondary SMTP Gateway Secondary SMTP Gateway Port (25*) SMTP Timeout (30 seconds*) Reply Address Always use SMTP default Reply Address(Off*) Use SSL/TLS(Disabled*) Require Trusted Certificate(On*) SMTP Server Authentication(No authentication required*) Device-Initiated E-mail(None*) Device Userid Device Password NTLM Domain	Configure the e-mail settings of the printer. Note: In some printer models, this menu can be configured only from the Embedded Web Server.
Error Prevention Jam Assist Off On*	Set the printer to check for jammed paper automatically.
Error Prevention Auto Continue Disabled 5–255 (5*) Auto Continue Time	Let the printer continue processing or printing a job automatically after clearing certain attendance conditions. Note: Auto Continue Time is available only in some printer models.
Error Prevention Auto Reboot Auto Reboot Reboot always* Reboot never Reboot when idle	Set the printer to restart when an error occurs.
Note: An asterisk (*) next to a value indicates the factory default setting.	

Menu item	Description
Error Prevention Auto Reboot Max Auto Reboots 1–20 (2*)	Set the number of automatic reboots that the printer can perform.
Error Prevention Auto Reboot Auto Reboot Window 1–525600 (720*)	Set the number of seconds before the printer performs an automatic reboot.
Error Prevention Auto Reboot Auto Reboot Counter	Show a read-only information of the reboot counter.
Error Prevention Display Short Paper Error Auto-clear* On	Set the printer to show a message when a short paper error occurs. Note: Short paper refers to the size of the paper loaded.
Error Prevention Page Protect Off* On	Set the printer to process the entire page into the memory before printing it.
Jam Content Recovery Jam Recovery Auto* Off On	Set the printer to reprint jammed pages.
Note: An asterisk (*) next to a value indicates the factory default setting.	

Power Management

Menu item	Description
Sleep Mode Profile Print from Sleep Mode Stay awake after printing Enter Sleep Mode after printing*	Set the printer to stay in Ready mode or return to Sleep mode after printing.
Timeouts Sleep Mode 1–60 minutes (15*)	Set the idle time before the printer begins operating in Sleep mode.
Note: An asterisk (*) next to a value indicates the factory default setting.	

Menu item	Description
Timeouts Hibernate Timeout Disabled 1 hour 2 hours 3 hours 6 hours 1 day 2 days 3 days* 1 week 2 weeks 1 month	Set the time before the printer turns off.
Timeouts Hibernate Timeout on Connection Hibernate Do Not Hibernate*	Set Hibernate Timeout to turn off the printer while an active Ethernet connection exists.
Note: An asterisk (*) next to a value indicates the factory default setting.	

Information Sent to Lexmark

Menu item	Description
Information Sent to Lexmark Supplies and Page Usage Device Performance None*	Send printer usage and performance information to Lexmark. Note: Information Send Time appears only when you select any of the settings in Information Sent to Lexmark, except None.
Information Send Time Start Time Stop Time	
Note: An asterisk (*) next to a value indicates the factory default setting.	

Restore Factory Defaults

Menu item	Description
Restore Settings Restore all settings Restore printer settings Restore network settings	Restore the printer factory default settings.

Maintenance

Config Menu

Menu item	Description
USB Configuration USB PnP 1* 2	Change the USB driver mode of the printer to improve its compatibility with a personal computer.
USB Configuration USB Speed Full Auto*	Set the USB port to run at full speed and disable its high-speed capabilities.
Tray Configuration Tray Linking Automatic* Off	Set the printer to link the trays that have the same paper type and paper size settings. Note: This menu item is available only in some printer models.
Tray Configuration Show Tray Insert Message Off Only for unknown sizes* Always	Display a message to select paper size and type after inserting the tray.
Tray Configuration A5 Loading Short Edge Long Edge*	Specify the page orientation when loading A5 paper size.
Tray Configuration Paper Prompts Auto* Manual Paper	Set the paper source that the user fills when a prompt to load paper appears.
Tray Configuration Envelope Prompts Auto* Manual Envelope	Set the paper source that the user fills when a prompt to load envelope appears.
Tray Configuration Action for Prompts Prompt user* Continue Use current	Set the printer to resolve paper- or envelope-related change prompts.

Note: An asterisk (*) next to a value indicates the factory default setting.

Menu item	Description
Reports Menu Settings Page Event Log Event Log Summary	Print reports about printer menu settings, status, and event logs.
Supply Usage And Counters Clear Supply Usage History	Reset the supply usage history, such as number of pages and days remaining, to the factory shipped level.
Supply Usage And Counters Fuser Reset ITM Reset	Reset the counter after installing a new supply.
Printer Emulations PPDS Emulation Off* On	Set the printer to recognize and use the PPDS data stream.
Printer Emulations PS Emulation On* Off	Set the printer to recognize and use the PS data stream.
Printer Emulations Emulator Security Page Timeout 0–60 (60*)	Set the page timeout during emulation.
Printer Emulations Emulator Security Reset Emulator After Job Off* On	Reset the emulator after a print job.
Printer Emulations Emulator Security Disable Printer Message Access On* Off	Disable access to printer message during emulation.
Print Configuration Black Only Mode Off* On	Print color content in grayscale.
Note: An asterisk (*) next to a value indicates the factory default setting.	

Menu item	Description
Print Configuration Color Trapping Off 1 2* 3 4 5	Enhance the printed output to compensate for misregistration in the printer.
Print Configuration Font Sharpening 0–150 (24*)	Set a text point-size value below which the high-frequency screens are used when printing font data. For example, if the value is 24, then all fonts sized 24 points or less use the high-frequency screens.
Device Operations Quiet Mode Off* On	Set the printer to operate in Quiet Mode. Note: Enabling this setting slows down the printer performance.
Device Operations Safe Mode Off* On	Set the printer to operate in a mode in which it attempts to continue offering as much functionality as possible, despite known issues. For example, when set to On, and the duplex motor is nonfunctional, the printer performs one-sided printing of the documents even if the job is two-sided printing. Note: This menu item is available only in some printer models.
Device Operations Clear Custom Status	Erase user-defined strings for the Default or Alternate custom messages.
Device Operations Clear all remotely-installed messages	Erase messages that were remotely installed. Note: This menu item is available only in some printer models.
Device Operations Automatically Display Error Screens On* Off	Show existing error messages on the display after the printer remains inactive on the home screen for a length of time equal to the Screen Timeout setting. Note: This menu item is available only in some printer models.
Toner patch sensor setup Calibration frequency preference Disabled Fewest color adjustments Fewer color adjustments Normal* Better color accuracy Best color accuracy	Set the default calibration frequency.
Note: An asterisk (*) next to a value indicates the factory default setting.	

Menu item	Description
Toner patch sensor setup Full calibration	Run the full color calibration.
Toner patch sensor setup Print TPS information page	Print a diagnostic page that contains toner patch sensor calibration.
Note: An asterisk (*) next to a value indicates the factory default setting.	

Out of Service Erase

Menu item	Description
Erase Printer Memory Printer Memory Last Sanitized Sanitize all information on nonvolatile memory Erase all printer and network settings Erase all shortcuts and shortcut settings	Clear all settings and applications that are stored in the printer.
Note: *Available only in some printer models.	

Visible Home Screen Icons

Menu	Description
Status/Supplies Job Queue Change Language Bookmarks Held Jobs	Specify which icons to show on the home screen.

About this Printer

Menu item	Description
Asset Tag	Show the serial number of the printer.
Printer's Location	Identify the printer location. The maximum length is 63 characters.
Contact	Personalize the printer name. The maximum length is 63 characters.
Send Logs Cancel Send	Send diagnostic information to Lexmark.

Print

Layout

Menu item	Description
Sides 1-sided* 2-sided	Specify whether to print on one side or two sides of the paper.
Flip Style Long Edge* Short Edge	Determine which side of the paper (long edge or short edge) is bound when performing two-sided printing. Note: Depending on the option selected, the printer automatically offsets each printed information of the page to bind the job correctly.
Blank Pages Print Do Not Print*	Print blank pages that are included in a print job.
Collate Off [1,1,1,2,2,2]* On [1,2,1,2,1,2]	Keep the pages of a print job stacked in sequence, particularly when printing multiple copies of the job.
Separator Sheets None* Between Copies Between Jobs Between Pages	Insert blank separator sheets when printing.
Separator Sheet Source Tray [x] (1*)	Specify the paper source for the separator sheet.
Pages per Side Off* 2 pages per side 3 pages per side 4 pages per side 6 pages per side 9 pages per side 12 pages per side 16 pages per side	Print multiple page images on one side of a sheet of paper.
Pages per Side Ordering Horizontal* Reverse Horizontal Vertical Reverse Vertical	Specify the positioning of multiple page images when using Pages per Side. Note: The positioning depends on the number of page images and their page orientation.
Note: An asterisk (*) next to a value indicates the factory default setting.	

Menu item	Description
Pages per Side Orientation Auto* Landscape Portrait	Specify the orientation of a multiple-page document when using Pages per Side.
Pages per Side Border None* Solid	Print a border around each page image when using Pages per Side.
Copies 1–9999 (1*)	Specify the number of copies for each print job.
Print Area Normal* Fit to Page Whole Page	Set the printable area on a sheet of paper.
Note: An asterisk (*) next to a value indicates the factory default setting.	

Setup

Menu item	Description
Printer Language PCL Emulation PS Emulation*	Set the printer language. Note: Setting a printer language default does not prevent a software program from sending print jobs that use another printer language.
Printer Usage Max Speed Max Yield*	Determine how the color print cartridges operate during printing. Notes: <ul style="list-style-type: none"> • When set to Max Yield, the color print cartridges slow down or stop while printing groups of black-only pages. • When set to Max Speed, the color print cartridges always run while printing, whether color or black pages are being printed.
Resource Save Off* On	Determine what the printer does with downloaded resources, such as fonts and macros, when it receives a job that requires more than the available memory. Notes: <ul style="list-style-type: none"> • When set to Off, the printer retains downloaded resources only until memory is needed. Resources associated with the inactive printer language are deleted. • When set to On, the printer preserves all the permanent downloaded resources across all language switches. When necessary, the printer shows memory full messages instead of deleting permanent resources.
Note: An asterisk (*) next to a value indicates the factory default setting.	

Menu item	Description
Print All Order Alphabetical* Newest First Oldest First	Specify the order in which held and confidential jobs are printed when Print All is selected.
Note: An asterisk (*) next to a value indicates the factory default setting.	

Quality

Menu item	Description
Print Mode Black and White Color*	Set the print mode.
Print Resolution 4800 CQ*	Set the resolution for the printed output. Note: 4800 CQ provides high-quality output at maximum speed.
Toner Darkness Light Normal* Dark	Determine the lightness or darkness of text images.
Halftone Normal* Detail	Enhance the printed output to have smoother lines with sharper edges.
RGB Brightness -6 to 6 (0*)	Adjust the brightness, contrast, and saturation for color output. Note: This setting does not affect files where CMYK color specifications are used.
RGB Contrast 0 to 5 (0*)	
RGB Saturation 0 to 5 (0*)	
Note: An asterisk (*) next to a value indicates the factory default setting.	

Advanced Imaging

Menu item	Description
Color Balance Cyan -5 to 5 (0*) Magenta -5 to 5 (0*) Yellow -5 to 5 (0*) Black -5 to 5 (0*) Reset Defaults	Adjust the amount of toner that is used for each color.
Color Correction Color Correction Auto* Off Manual Color Correction Content	Modify the color settings used to print documents. Notes: <ul style="list-style-type: none"> • Off sets the printer to receive the color correction from the software. • Auto sets the printer to apply different color profiles to each object on the printed page. • Manual allows the customization of the RGB or CMYK color conversions applied to each object on the printed page. • Color Correction Content is available only when Color Correction is set to Manual.
Color Adjust	Calibrate the printer to adjust color variations in the printed output.
Note: An asterisk (*) next to a value indicates the factory default setting.	

PostScript

Menu item	Description
Print PS Error On Off*	Print a page that describes the PostScript® error. Note: When an error occurs, processing of the job stops, the printer prints an error message, and the rest of the print job is flushed.
Minimum Line Width 1–30 (2*)	Set the minimum stroke width. Note: Jobs printed in 4800 CQ use half the value.
Lock PS Startup Mode On* Off	Disable the SysStart file. Note: The default setting varies depending on the printer model.
Image Smoothing On Off*	Enhance the contrast and sharpness of low-resolution images. Note: This setting has no effect on images with a resolution of 300 dpi or higher.
Wait Timeout Disabled Enabled*	Enable the printer to wait for more data before canceling a print job.
Note: An asterisk (*) next to a value indicates the factory default setting.	

Menu item	Description
Wait Timeout Time 15–65535 (40*)	Set the time in seconds for the printer to wait for more data before canceling a print job. Note: This menu item appears only when Wait Timeout is enabled.
Note: An asterisk (*) next to a value indicates the factory default setting.	

PCL

Menu item	Description
Font Name [List of available fonts] (Courier*)	Select a font from the specified font source.
Symbol Set [List of available symbol set] (10U PC-8*)	Specify the symbol set for each font name. Note: A symbol set is a set of alphabetic and numeric characters, punctuation, and special symbols. Symbol sets support the different languages or specific programs such as math symbols for scientific text.
Pitch 0.08–100 (10*)	Specify the pitch for fixed or monospaced fonts. Note: Pitch refers to the number of fixed-space characters in a horizontal inch of type.
Orientation Portrait* Landscape Reverse Portrait Reverse Landscape	Specify the orientation of text and graphics on the page.
Lines per Page 1–255	Specify the number of lines of text for each page printed through the PCL® datastream. Notes: <ul style="list-style-type: none"> This menu item activates vertical escapement that causes the selected number of requested lines to print between the default margins of the page. 60 is the U.S. factory default setting. 64 is the international factory default setting.
PCL5 Minimum Line Width 1–30 (2*)	Set the initial minimum stroke width. Note: Jobs printed in 4800 CQ use half the value.
PCLXL Minimum Line Width 1–30 (2*)	
A4 Width 198 mm* 203 mm	Set the width of the logical page on A4-size paper. Note: Logical page is the space on the physical page where data is printed.
Note: An asterisk (*) next to a value indicates the factory default setting.	

Menu item	Description
Auto CR after LF Off* On	Set the printer to perform a carriage return after a line feed control command. Note: Carriage return is a mechanism that commands the printer to move the position of the cursor to the first position on the same line.
Auto LF after CR Off* On	Set the printer to perform a line feed after a carriage return control command.
Tray Renumber Assign Tray [x] Off* None 0–201 Assign Manual Paper Off* None 0–201 Assign Manual Envelope Off* None 0–201	Configure the printer to work with print drivers or applications that use different source assignments for the paper source.
Tray Renumber View Factory Defaults	Show the factory default setting assigned for each paper source.
Tray Renumber Restore Defaults	Return all tray assignments to factory default values.
Print Timeout Disabled Enabled* [90]	Set the printer to end a print job after it has been idle for the specified amount of time in seconds. Note: Print Timeout Time appears only in some printer models.
Print Timeout Time 1–255 (90*)	
Note: An asterisk (*) next to a value indicates the factory default setting.	

Image

Menu item	Description
Auto Fit On Off*	Select the best available paper size and orientation setting for an image. Note: When set to On, this menu item overrides the scaling and orientation settings for the image.
Invert Off* On	Invert bitonal monochrome images. Note: This menu item does not apply to GIF or JPEG image formats.
Note: An asterisk (*) next to a value indicates the factory default setting.	

Menu item	Description
Scaling Anchor Top Left Best Fit* Anchor Center Fit Height/Width Fit Height Fit Width	Adjust the image to fit the printable area. Note: When Auto Fit is set to On, Scaling is automatically set to Best Fit.
Orientation Portrait* Landscape Reverse Portrait Reverse Landscape	Specify the orientation of text and graphics on the page.
Note: An asterisk (*) next to a value indicates the factory default setting.	

Paper

Tray Configuration

Menu item	Description
Default Source Tray [x] (1*) Manual Paper Manual Envelope	Set the paper source for all print jobs.
Paper Size/Type Tray [x] (1*) Manual Paper Manual Envelope	Specify the paper size or paper type loaded in each paper source.
Substitute Size Off Letter/A4 All Listed*	Set the printer to substitute a specified paper size if the requested size is not loaded in any paper source. Notes: <ul style="list-style-type: none"> • Off prompts the user to load the required paper size. • Letter/A4 prints an A4-size document on letter when loading letter, and letter-size jobs on A4 paper size when loading A4. • All Listed substitutes Letter/A4.
Note: An asterisk (*) next to a value indicates the factory default setting.	

Media Configuration

Universal Setup

Menu item	Description
Units of Measure Inches Millimeters	Specify the unit of measurement for the universal paper. Note: Inches is the U.S. factory default setting. Millimeters is the international factory default setting.
Portrait Width 3.00–14.17 inches (8.50*) 76–360 mm (216*)	Set the portrait width of the universal paper.
Portrait Height 3.00–14.17 inches (14*) 76–360 mm (356*)	Set the portrait height of the universal paper.
Feed Direction Short Edge* Long Edge	Set the printer to pick paper from the short edge or long edge direction. Note: Long Edge appears only when the longest edge is shorter than the maximum width supported.
Note: An asterisk (*) next to a value indicates the factory default setting.	

Media Types

Menu item	Description
Plain Paper Card Stock Recycled Glossy Labels Bond Envelope Letterhead Preprinted Colored Paper Light Heavy Rough/Cotton Custom Type [x]	Specify the texture, weight, and orientation of the paper loaded. Note: Custom Type is supported only in some printer models.

Network/Ports

Network Overview

Menu item	Description
Active Adapter Auto* Standard Network Wireless	Specify how a network is connected.
Network Status	Show the printer network status and connectivity settings.
Display Network Status on Printer Off On*	Show the network status on the display.
Speed, Duplex	Show the speed of the currently active network card.
IPv4	Show the IPv4 address.
All IPv6 Addresses	Show all IPv6 addresses.
Reset Print Server Start	Reset all active network connections to the printer. Note: This setting removes all network configuration settings.
Network Job Timeout Off On* (90 seconds)	Set the time before the printer cancels a network print job. Note: Network Job Timeout Time appears only in some printer models.
Network Job Timeout Disabled Enabled*	
Network Job Timeout Time 10–255 seconds (90*)	
Banner Page Off* On	Print a banner page.
Enable Network Connections Enable* Disable	Enable or disable all network connections.
Enable LLDP On Off*	Enable Link Layer Discovery Protocol (LLDP) in the printer.
Note: An asterisk (*) next to a value indicates the factory default setting.	

Wireless

Menu item	Description
Setup Using Mobile App	Configure the wireless connection using the Lexmark Mobile Assistant app.
Setup On Printer Panel Choose Network Add Wi-Fi Network <ul style="list-style-type: none"> • Network Name • Network Mode <ul style="list-style-type: none"> Infrastructure • Wireless Security Mode <ul style="list-style-type: none"> Disabled* WEP WPA2/WPA - Personal WPA2 - Personal 	Determine the wireless network that the printer connects to. Note: This menu item appears as <i>Wireless Connection Setup</i> in the Embedded Web Server.
Wi-Fi Protected Setup Start Push Button Method Start PIN Method	Establish a wireless network and enable network security. Notes: <ul style="list-style-type: none"> • Start Push Button Method connects the printer to a wireless network when buttons on both the printer and the access point (wireless router) are pressed within a given time. • Start PIN Method connects the printer to a wireless network when a PIN on the printer is entered into the wireless settings of the access point.
Enable Wi-Fi Direct On Off*	Set the printer to connect directly to Wi-Fi devices.
Compatibility 802.11b/g/n (2.4GHz) 802.11a/b/g/n/ac (2.4GHz/5GHz)* 802.11a/n/ac (5GHz)	Specify the wireless standard for the wireless network.
Wireless Security Mode Disabled* WEP WPA2/WPA - Personal WPA2 - Personal 802.1x - RADIUS	Set the type of security for connecting the printer to wireless devices.
WEP Authentication Mode Auto* Open Shared	Set the type of Wireless Encryption Protocol (WEP) used by the printer. Note: This menu item appears only if Wireless Security Mode is set to WEP.
Set WEP Key	Specify a WEP password for secure wireless connection. Note: This menu item appears only if Wireless Security Mode is set to WEP.

Menu item	Description
WPA2-Personal AES*	Enable wireless security through WPA2. Note: This menu item appears only if Wireless Security Mode is set to WPA2-Personal.
Set PSK	Set the password for secure wireless connection. Note: This menu item appears only if Wireless Security Mode is set to WPA2/WPA-Personal or WPA2-Personal.
WPA2/WPA-Personal AES*	Enable wireless security through WPA2/WPA. Note: This menu item appears only when Wireless Security Mode is set to WPA2/WPA-Personal.
802.1x Encryption Mode WPA+ WPA2*	Enable wireless security through 802.1x standard. Note: This menu item appears only when Wireless Security Mode is set to 802.1x - Radius.
IPv4 Enable DHCP On* Off	Enable Dynamic Host Configuration Protocol (DHCP). Note: DHCP is a standard protocol that allows a server to distribute IP addressing and configuration information dynamically to clients.
IPv4 Set Static IP Address IP Address Netmask Gateway	Set the static IP address of your printer.
IPv6 Enable IPv6 On* Off	Enable IPv6 in the printer.
IPv6 Enable DHCPv6 Off* On	Enable DHCPv6 in the printer.
IPv6 Stateless Address Autoconfiguration Off On*	Set the network adapter to accept the automatic IPv6 address configuration entries provided by a router.
IPv6 DNS Address	Specify the DNS server address.
IPv6 Manually Assigned IPV6 Address	Assign the IPv6 address. Note: This menu item appears only in some printer models.
IPv6 Manually Assigned IPV6 Router	Assign the IPv6 router address. Note: This menu item appears only in some printer models.

Menu item	Description
IPv6 Address Prefix 0–128 (64*)	Specify the address prefix.
IPv6 All IPv6 Addresses	Show all IPv6 addresses.
IPv6 All IPv6 Router Addresses	Show all IPv6 router addresses.
Network Address UAA LAA	View the network addresses.
PCL SmartSwitch On* Off	Set the printer to switch automatically to PCL emulation when a print job requires it, regardless of the default printer language. Note: If PCL SmartSwitch is off, then the printer does not examine incoming data and uses the default printer language specified in the Setup menu.
PS SmartSwitch On* Off*	Set the printer to switch automatically to PostScript emulation when a print job requires it, regardless of the default printer language. Note: If PS SmartSwitch is off, then the printer does not examine incoming data and uses the default printer language specified in the Setup menu.
Mac Binary PS Auto* On Off	Set the printer to process Macintosh binary PostScript print jobs. Notes: <ul style="list-style-type: none"> • On processes raw binary PostScript print jobs. • Off filters print jobs using the standard protocol.

Ethernet

Menu item	Description
Network Speed	Show the speed of an active network adapter.
IPv4 Enable DHCP On* Off	Enable Dynamic Host Configuration Protocol (DHCP). Note: DHCP is a standard protocol that allows a server to distribute IP addressing and configuration information to clients in a dynamic manner.
IPv4 Set Static IP Address IP Address Netmask Gateway	Set the static IP address of your printer.
Note: An asterisk (*) next to a value indicates the factory default setting.	

Menu item	Description
IPv6 Enable IPv6 Off On*	Enable IPv6 in the printer.
IPv6 Enable DHCPv6 Off* On	Enable DHCPv6 in the printer.
IPv6 Stateless Address Autoconfiguration Off On*	Set the network adapter to accept the automatic IPv6 address configuration entries provided by a router.
IPv6 DNS Address	Specify the DNS server address.
IPv6 Manually Assigned IPV6 Address	Assign the IPv6 address. Note: This menu item appears only in some printer models.
IPv6 Manually Assigned IPV6 Router	Assign the IPv6 router address. Note: This menu item appears only in some printer models.
IPv6 Address Prefix 0–128 (64*)	Specify the address prefix.
IPv6 All IPv6 Addresses	Show all IPv6 addresses.
IPv6 All IPv6 Router Addresses	Show all IPv6 router addresses.
Network Address UAA LAA	Show the printer Media Access Control (MAC) addresses: Locally Administered Address (LAA) and Universally Administered Address (UAA). Note: You can change the printer LAA manually.
PCL SmartSwitch Off On*	Set the printer to switch automatically to PCL emulation when a print job requires it, regardless of the default printer language. Note: If PCL SmartSwitch is off, then the printer does not examine incoming data and uses the default printer language specified in the Setup menu.
PS SmartSwitch On* Off*	Set the printer to switch automatically to PS emulation when a print job requires it, regardless of the default printer language. Note: If PS SmartSwitch is off, then the printer does not examine incoming data and uses the default printer language specified in the Setup menu.
Note: An asterisk (*) next to a value indicates the factory default setting.	

Menu item	Description
Mac Binary PS Auto* On Off	Set the printer to process Macintosh binary PostScript print jobs. Notes: <ul style="list-style-type: none"> • On processes raw binary PostScript print jobs. • Off filters print jobs using the standard protocol.
Energy Efficient Ethernet Off On Auto*	Reduce power consumption when the printer does not receive data from the Ethernet network.
Note: An asterisk (*) next to a value indicates the factory default setting.	

TCP/IP

Note: This menu appears only in network printers or printers attached to print servers.

Menu item	Description
Set Hostname	Set the current TCP/IP host name.
Domain Name	Set the domain name. Note: This menu item appears only in some printer models.
Allow DHCP/BOOTP to update NTP server On* Off	Allow the DHCP and BOOTP clients to update the NTP settings of the printer.
Zero Configuration Name	Specify a service name for the zero configuration network. Note: This menu item appears only in some printer models.
Enable Auto IP On* Off	Assign an IP address automatically.
DNS Address	Specify the current Domain Name System (DNS) server address.
Backup DNS Address	Specify the backup DNS server addresses.
Backup DNS Address 2	
Backup DNS Address 3	
Domain Search Order	Specify a list of domain names to locate the printer and its resources that reside in different domains on the network. Note: This menu item appears only in some printer models.
Enable DDNS On Off*	Update the Dynamic DNS settings.
Note: An asterisk (*) next to a value indicates the factory default setting.	

Menu item	Description
DDNS TTL	Specify the current DDNS settings.
Default TTL	
DDNS Refresh Time	
Enable mDNS Off On*	Update multicast DNS settings.
WINS Address	Specify a server address for Windows Internet Name Service (WINS).
Enable BOOTP Off* On	Allow the BOOTP to assign a printer IP address.
Restricted Server List	Specify an IP address for the TCP connections. Notes: <ul style="list-style-type: none"> • This menu item appears only in some printer models. • Use a comma to separate each IP address. • You can add up to 50 IP addresses.
Restricted Server List Options Block All Ports* Block Printing Only Block Printing and HTTP Only	Specify how the IP addresses in the list can access the printer functionality. Note: This menu item appears only in some printer models.
MTU	Specify a maximum transmission unit (MTU) parameter for the TCP connections.
Raw Print Port 1–65535 (9100*)	Specify a raw port number for printers connected on a network.
Outbound Traffic Maximum Speed Disabled* Enabled	Enable the printer maximum transfer rate.
Enable TLSv1.0 Off On*	Enable the TLSv1.0 protocol.
Enable TLSv1.1 Off On*	Enable the TLSv1.1 protocol.
SSL Cipher List	Specify the cipher algorithms to use for the SSL or the TLS connections.
Note: An asterisk (*) next to a value indicates the factory default setting.	

SNMP

Note: This menu appears only in network printers or printers that are attached to print servers.

Menu item	Description
<p>SNMP Versions 1 and 2c</p> <ul style="list-style-type: none"> Enabled Off On* Allow SNMP Set Off On* Enable PPM MIB Off On* SNMP Community 	<p>Configure Simple Network Management Protocol (SNMP) versions 1 and 2c to install print drivers and applications.</p>
<p>SNMP Version 3</p> <ul style="list-style-type: none"> Enabled Off On* Set Read/Write Credentials <ul style="list-style-type: none"> User Name Password Set Read-only Credentials <ul style="list-style-type: none"> User Name Password Authentication Hash <ul style="list-style-type: none"> MD5 SHA1* Minimum Authentication Level <ul style="list-style-type: none"> No Authentication, No Privacy Authentication, No Privacy Authentication, Privacy* Privacy Algorithm <ul style="list-style-type: none"> DES AES-128* 	<p>Configure SNMP version 3 to install and update the printer security.</p>
<p>Note: An asterisk (*) next to a value indicates the factory default setting.</p>	

IPSec

Note: This menu appears only in network printers or printers that are attached to print servers.

Menu item	Description
<p>Enable IPSec</p> <ul style="list-style-type: none"> Off* On 	<p>Enable Internet Protocol Security (IPSec).</p>
<p>Note: An asterisk (*) next to a value indicates the factory default setting.</p>	

Menu item	Description
Base Configuration Default* Compatibility Secure	Set the IPSec base configuration. Note: This menu item appears only when Enable IPSec is set to On.
DH (Diffie-Hellman) Group Proposal modp2048 (14)* modp3072 (15) modp4069 (16) modp6144 (17)	Set the IPSec encryption. Notes: <ul style="list-style-type: none"> • DH (Diffie-Hellman) Group Proposal appears only when Base Configuration is set to Compatibility. • IKE SA Lifetime (Hours) and IPSec SA Lifetime (Hours) appear only when Base Configuration is set to Secure.
IKE SA Lifetime (Hours) 1 2 4 8 24*	
IPSec SA Lifetime (Hours) 1 2 4 8* 24	
Proposed Encryption Method 3DES AES*	Specify the encryption and authentication methods to connect to a network securely. Note: These menu items appear only when Base Configuration is set to Compatibility.
Proposed Authentication Method SHA1 SHA256* SHA512	
IPSec Device Certificate	Specify an IPSec certificate. Note: This menu item appears only when Enable IPSec is set to On.
Pre-Shared Key Authenticated Connections Host [x] Address Key	Configure the authenticated connections of the printer. Note: These menu items appear only when Enable IPSec is set to On.
Certificate Authenticated Connections Host [x] Address[/subnet] Address[/subnet]	
Note: An asterisk (*) next to a value indicates the factory default setting.	

802.1x

Note: This menu appears only in network printers or printers that are attached to print servers.

Menu item	Description
Active Off* On	Let the printer join networks that require authentication before allowing access.
Note: An asterisk (*) next to a value indicates the factory default setting.	

LPD Configuration

Note: This menu appears only in network printers or printers that are attached to print servers.

Menu item	Description
LPD Timeout 0–65535 seconds (90*)	Set the time-out value to stop the Line Printer Daemon (LPD) server from waiting indefinitely for hung or invalid print jobs.
LPD Banner Page Off* On	Print a banner page for all LPD print jobs. Note: A banner page is the first page of a print job used as a separator of print jobs and to identify the originator of the print job request.
LPD Trailer Page Off* On	Print a trailer page for all LPD print jobs. Note: A trailer page is the last page of a print job.
LPD Carriage Return Conversion Off* On	Enable carriage return conversion. Note: Carriage return is a mechanism that commands the printer to move the position of the cursor to the first position on the same line.
Note: An asterisk (*) next to a value indicates the factory default setting.	

HTTP/FTP Settings

Menu item	Description
Enable HTTP Server Off On*	Access the Embedded Web Server to monitor and manage the printer.
Enable HTTPS Off On*	Configure the Hypertext Transfer Protocol Secure (HTTPS) settings.
Force HTTPS Connections On Off*	Force the printer to use the HTTPS connections.
Note: An asterisk (*) next to a value indicates the factory default setting.	

Menu item	Description
Enable FTP/TFTP Off On*	Send files using FTP.
Local Domains	Specify domain names for HTTP and FTP servers. Note: This menu item appears only in the Embedded Web Server.
HTTP Proxy IP Address	Configure the HTTP and FTP server settings. Note: HTTP Proxy IP Address and FTP Proxy IP Address appear only in the Embedded Web Server.
FTP Proxy IP Address	
HTTP Default IP Port 1–65535 (80*)	
HTTPS Device Certificate	
FTP Default IP Port 1–65535 (21*)	
Timeout for HTTP/FTP Requests 1–299 (30*)	Specify the amount of time before the server connection stops.
Retries for HTTP/FTP Requests 1–299 (3*)	Set the number of retries to connect to the HTTP/FTP server.
Note: An asterisk (*) next to a value indicates the factory default setting.	

USB

Menu item	Description
PCL SmartSwitch Off On*	Set the printer to switch to PCL emulation when a print job received through a USB port requires it, regardless of the default printer language. Note: If PCL SmartSwitch is off, then the printer does not examine incoming data and uses the default printer language specified in the Setup menu.
PS SmartSwitch Off On*	Set the printer to switch to PS emulation when a print job received through a USB port requires it, regardless of the default printer language. Note: If PS SmartSwitch is off, then the printer does not examine incoming data and uses the default printer language specified in the Setup menu.
Mac Binary PS On Auto* Off	Set the printer to process Macintosh binary PostScript print jobs. Notes: <ul style="list-style-type: none"> • When set to On, the printer processes raw binary PostScript print jobs from computers using the Macintosh operating system. • When set to Auto, the printer processes print jobs from computers using either Windows or Macintosh operating systems • When set to Off, the printer filters PostScript print jobs using the standard protocol.
Note: An asterisk (*) next to a value indicates the factory default setting.	

Menu item	Description
Enable USB Port Disable Enable*	Enable the standard USB port.
Note: An asterisk (*) next to a value indicates the factory default setting.	

Restrict external network access

Menu item	Description
Restrict external network access Off* On	Restrict access to network sites.
External network address	Specify the network addresses with restricted access.
E-mail address for notification	Specify an e-mail address to send a notification of logged events.
Ping frequency 1–300 (10*)	Specify the network query interval in seconds.
Subject	Specify the subject and message of the notification e-mail.
Message	
Note: An asterisk (*) next to a value indicates the factory default setting.	

Wi-Fi Direct

Note: This menu appears only when a direct Wi-Fi network is the active network.

Menu item	Description
SSID	Specify the service set identifier (SSID) of the Wi-Fi network.
Preferred Channel Number Auto 1–11 (6*)	Show the PSK on the Network Setup Page.
Set PSK	Set the preshared key (PSK) to authenticate and validate users on a Wi-Fi connection.
Show PSK on Setup Page Off On*	Show the PSK on the Network Setup Page.
Group Owner IP Address	Specify the IP address of the group owner.
Auto-Accept Push Button Requests Off* On	Accept requests to connect to the network automatically. Note: Accepting clients automatically is not secure.
Note: An asterisk (*) next to a value indicates the factory default setting.	

Google Cloud Print

Menu item	Description
Registration Register	Register the printer to the Google Cloud Print server.
Options Enable Google Cloud Print Off On*	Print directly from your Google account.
Options Enable Local Discovery Off On*	Allow the registered user and other users on the same subnet to send jobs to the printer locally.
Options Enable SSL Peer Verification Off On*	Verify authenticity of the peer certificate to connect to your Google account.
Options Always Print As Image Off* On	Set the printer to process files as images for faster printing.
Note: An asterisk (*) next to a value indicates the factory default setting.	

Security

Login Methods

Public

Menu item	Description
Manage Permissions Function Access Manage Bookmarks Held Jobs Access Cancel Jobs at the Device Change Language Internet Printing Protocol (IPP) B/W Print Color Print	Control access to the printer functions.

Menu item	Description
<p>Manage Permissions</p> <ul style="list-style-type: none"> Administrative Menus Security Menu Network/Ports Menu Paper Menu Reports Menu Function Configuration Menus Supplies Menu SE Menu Device Menu 	<p>Control access to the printer menus.</p>
<p>Manage Permissions</p> <ul style="list-style-type: none"> Device Management Remote Management Firmware Updates Embedded Web Server Access Import / Export All Settings Out of Service Erase 	<p>Control access to the printer management options.</p>

Local Accounts

Menu item	Description
<p>Add User</p> <ul style="list-style-type: none"> User Name/Password User Name Password PIN 	<p>Create local accounts to manage access to the printer functions.</p>
<p>Manage Groups/Permissions</p> <ul style="list-style-type: none"> Add Group <ul style="list-style-type: none"> Import Access Controls Function Access Administrative Menus Device Management All Users <ul style="list-style-type: none"> Import Access Controls Function Access Administrative Menus Device Management Admin <ul style="list-style-type: none"> Function Access Administrative Menus Device Management 	<p>Control group or user access to the printer functions, applications, and security settings.</p>

Certificate Management

Menu item	Menu item
Configure Certificate Defaults Common Name Organization Name Unit Name Country/Region Province Name City Name Subject Alternate Name	Set the default values for generated certificates.
Device Certificates	Generate, delete, or view device certificates.
Manage CA Certificates	Load, delete, or view Certificate Authority (CA) certificates.

Login Restrictions

Menu item	Description
Login failures 1–10 (3*)	Specify the number of failed login attempts before the user gets locked out.
Failure time frame 1–60 minutes (5*)	Specify the time frame between failed login attempts before the user gets locked out.
Lockout time 1–60 minutes (5*)	Specify the lockout duration.
Web Login Timeout 1–120 minutes (10*)	Specify the delay for a remote login before the user is logged off automatically.
Note: An asterisk (*) next to a value indicates the factory default setting.	

Confidential Print Setup

Menu item	Description
Max Invalid PIN 2–10 (0*)	Set the number of times an invalid PIN can be entered. Notes: <ul style="list-style-type: none"> • A value of zero turns off this setting. • When the limit is reached, the print jobs for that user name and PIN are deleted.
Note: An asterisk (*) next to a value indicates the factory default setting.	

Menu item	Description
Confidential Job Expiration Off* 1 Hour 4 Hours 24 Hours 1 Week	Set the expiration time for confidential print jobs. Notes: <ul style="list-style-type: none"> • If this menu item is changed while confidential print jobs reside in the printer memory, then the expiration time for those print jobs does not change to the new default value. • If the printer is turned off, then all confidential jobs held in the printer memory are deleted.
Repeat Job Expiration Off* 1 Hour 4 Hours 24 Hours 1 Week	Set the expiration time for a print job that you want to repeat.
Verify Job Expiration Off* 1 Hour 4 Hours 24 Hours 1 Week	Set the expiration time that the printer prints a copy for the user to examine its quality, before printing the remaining copies.
Reserve Job Expiration Off* 1 Hour 4 Hours 24 Hours 1 Week	Set the expiration time that the printer stores print jobs for printing later.
Require All Jobs to be Held Off* On	Set the printer to hold all print jobs.
Keep duplicate documents Off* On	Allow the storage of documents with the same file name.
Note: An asterisk (*) next to a value indicates the factory default setting.	

Erase Temporary Data Files

Menu item	Description
Stored in onboard memory Off* On	Delete all files stored on the printer memory.
Note: An asterisk (*) next to a value indicates the factory default setting.	

Miscellaneous

Menu item	Description
Print Permission Off* On	Allow the user to print.
Security Reset Jumper Enable "Guest" access* No Effect	Specify user access to the printer. Notes: <ul style="list-style-type: none"> • The jumper is located beside a lock icon on the controller board. • Enable "Guest" access gives anyone access to all aspects of the printer. • No Effect may make access to the printer impossible when the required security information is unavailable.
Minimum Password Length 0–32	Specify the password length.
Note: An asterisk (*) next to a value indicates the factory default setting.	

Cloud Connector

Cloud Connector

Menu item	Description
Enable/Disable Connectors	Enable a cloud service provider.

Reports

Menu Settings Page

Menu item	Description
Menu Settings Page	Print a report that contains the printer menus.

Device

Menu item	Description
Device Information	Print a report that contains information about the printer.
Device Statistics	Print a report about printer usage and supply status.
Profile List	Print a list of profiles that are stored in the printer.
Asset Report	Print a report that contains the printer serial number and model name.

Print

Menu item	Description
Print Fonts PCL Fonts PostScript Fonts	Print samples and information about the fonts that are available in each printer language.
Print Demo Demo Page	Print a demo page that is used as a diagnostic tool for print problems.

Network

Menu item	Description
Network Setup Page	Print a page that shows the configured network and wireless settings on the printer. Note: This menu item appears only in network printers or printers connected to print servers.
Wi-Fi Direct Connected Clients	Print a page that shows the list of devices that are connected to the printer using Wi-Fi Direct. Note: This menu item appears only when Enable Wi-Fi Direct is set to On.

Troubleshooting

Menu item	Description
Print Quality Test Pages	Print sample pages to identify and correct print quality defects.

Maintain the printer

Checking the status of parts and supplies

1 From the control panel, navigate to:

Settings > Reports > Device > Device Statistics

For non-touch-screen printer models, press  to navigate through the settings.

2 From the Supply Information section of the pages printed, check the status of parts and supplies.

Configuring supply notifications

1 Open a web browser, and then type the printer IP address in the address field.

Notes:

- View the printer IP address on the printer home screen. The IP address appears as four sets of numbers separated by periods, such as 123.123.123.123.
- If you are using a proxy server, then temporarily disable it to load the web page correctly.

2 Click **Settings > Device > Notifications**.

3 From the Supplies menu, click **Custom Supply Notifications**.

4 Select a notification for each supply item.

5 Apply the changes.

Setting up e-mail alerts

Configure the printer to send e-mail alerts when supplies are low, when paper must be changed or added, or when there is a paper jam.

1 Open a web browser, and then type the printer IP address in the address field.

Notes:

- View the printer IP address on the printer home screen. The IP address appears as four sets of numbers separated by periods, such as 123.123.123.123.
- If you are using a proxy server, then temporarily disable it to load the web page correctly.

2 Click **Settings > Device > Notifications > E-mail Alert Setup**, and then configure the settings.

3 Click **Setup E-mail Lists and Alerts**, and then configure the settings.

4 Apply the changes.

Viewing reports

1 From the control panel, navigate to:

Settings > Reports

For non-touch-screen printer models, press  to navigate through the settings.

2 Select the report that you want to view.

Ordering parts and supplies

To order supplies in the U.S., contact Lexmark at 1-800-539-6275 for information about Lexmark authorized supplies dealers in your area. In other countries or regions, go to www.lexmark.com or contact the place where you purchased the printer.

Note: All life estimates for printer supplies assume printing on letter- or A4-size plain paper.

Warning—Potential Damage: Failure to maintain optimum printer performance, or to replace parts and supplies, may cause damage to your printer.

Using genuine Lexmark parts and supplies

Your Lexmark printer is designed to function best with genuine Lexmark parts and supplies. Use of third-party supplies or parts may affect the performance, reliability, or life of the printer and its imaging components. It can also affect warranty coverage. Damage caused by the use of third-party parts and supplies is not covered by the warranty. All life indicators are designed to function with Lexmark parts and supplies, and may deliver unpredictable results if third-party parts and supplies are used. Imaging component usage beyond the intended life may damage your Lexmark printer or its associated components.

Warning—Potential Damage: Supplies and parts without Return Program agreement terms may be reset and remanufactured. However, the manufacturer's warranty does not cover any damage caused by non-genuine supplies or parts. Resetting counters on the supply or part without proper remanufacturing can cause damage to your printer. After resetting the supply or part counter, your printer may display an error indicating the presence of the reset item.

Ordering print cartridges

Notes:

- The estimated cartridge yield is based on the ISO/IEC 19798 standard.
- Extremely low print coverage for extended periods of time may negatively affect actual yield.

Lexmark CS331 and CS431 Return Program print cartridges

Item	United States and Canada	European Economic Area	Asia Pacific	Latin America	Rest of Europe, Middle East, and Africa
Return Program print cartridges					
Cyan	20N10C0	20N20C0	20N30C0	20N40C0	20N50C0
Magenta	20N10M0	20N20M0	20N30M0	20N40M0	20N50M0
Yellow	20N10Y0	20N20Y0	20N30Y0	20N40Y0	20N50Y0
Black	20N10K0	20N20K0	20N30K0	20N40K0	20N50K0
High yield Return Program print cartridges¹					
Cyan	20N1HC0	20N2HC0	20N3HC0	20N4HC0	20N5HC0
Magenta	20N1HM0	20N2HM0	20N3HM0	20N4HM0	20N5HM0
Yellow	20N1HY0	20N2HY0	20N3HY0	20N4HY0	20N5HY0
Black	20N1HK0	20N2HK0	20N3HK0	20N4HK0	20N5HK0
Extra high yield Return Program print cartridges²					
Cyan	20N1XC0	20N2XC0	20N3XC0	20N4XC0	20N5XC0
Magenta	20N1XM0	20N2XM0	20N3XM0	20N4XM0	20N5XM0
Yellow	20N1XY0	20N2XY0	20N3XY0	20N4XY0	20N5XY0
Black	20N1XK0	20N2XK0	20N3XK0	20N4XK0	20N5XK0
¹ Supported only in the Lexmark CS331 printer model. ² Supported only in the Lexmark CS431 printer model. For more information on countries located in each region, go to www.lexmark.com/regions .					

Lexmark CS331 Regular high yield print cartridges

Item	Part number
Cyan	20N0H20
Magenta	20N0H30
Yellow	20N0H40
Black	20N0H10

Lexmark CS431 Regular extra high yield print cartridges

Item	Part number
Cyan	20N0X20
Magenta	20N0X30
Yellow	20N0X40
Black	20N0X10

Lexmark C3224, C3326, and C3426 Return Program print cartridges

Item	United States and Canada	European Economic Area	Asia Pacific	Latin America Distribution	Rest of Europe, Middle East, and Africa
Return Program print cartridges					
Cyan	C3210C0	C3220C0	C3230C0	C3240C0	C3250C0
Magenta	C3210M0	C3220M0	C3230M0	C3240M0	C3250M0
Yellow	C3210Y0	C3220Y0	C3230Y0	C3240Y0	C3250Y0
Black	C3210K0	C3220K0	C3230K0	C3240K0	C3250K0
High yield Return Program print cartridges¹					
Cyan	C331HC0	C332HC0	C333HC0	C334HC0	C335HC0
Magenta	C331HM0	C332HM0	C333HM0	C334HM0	C335HM0
Yellow	C331HY0	C332HY0	C333HY0	C334HY0	C335HY0
Black	C331HK0	C332HK0	C333HK0	C334HK0	C335HK0
Extra high yield Return Program print cartridges²					
Cyan	C341XC0	C342XC0	C343XC0	C344XC0	C345XC0
Magenta	C341XM0	C342XM0	C343XM0	C344XM0	C345XM0
Yellow	C341XY0	C342XY0	C343XY0	C344XY0	C345XY0
Black	C341XK0	C342XK0	C343XK0	C344XK0	C345XK0
¹ Supported only in the Lexmark C3326 printer model.					
² Supported only in the Lexmark C3426 printer model.					

Lexmark C3224 Regular print cartridges

Item	Part number
Cyan	C320020
Magenta	C320030
Yellow	C320040
Black	C320010

Lexmark C3326 Regular high yield print cartridges

Item	Part number
Cyan	C330H20
Magenta	C330H30
Yellow	C330H40
Black	C330H10

Lexmark C3426 Regular extra high yield print cartridges

Item	Part number
Cyan	C340X20
Magenta	C340X30
Yellow	C340X40
Black	C340X10

Ordering a waste toner bottle

Item	Part number
Waste toner bottle	20NOW00

Replacing parts and supplies

Replacing a print cartridge

Note: If the tray is extended, then remove it before replacing a cartridge.

- 1 Open the front door, and then firmly push it down.

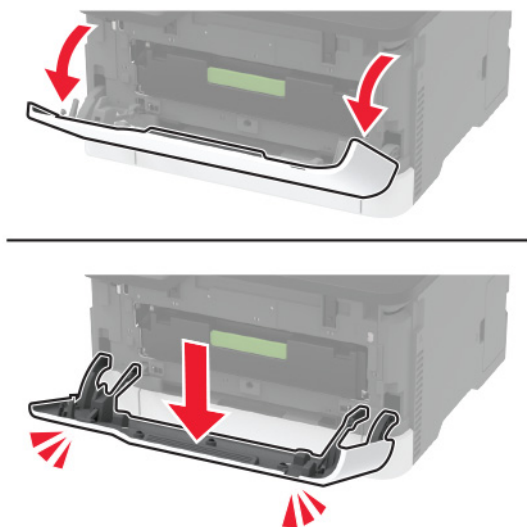

- 2 Pull out the print cartridge tray.



- 3 Remove the used print cartridge.

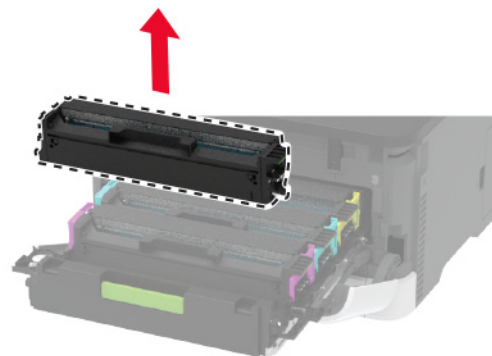
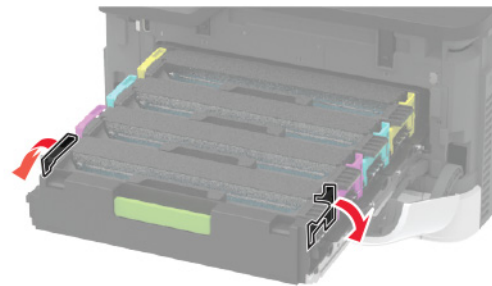

- 4 Unpack the new print cartridge.

Warning—Potential Damage: Do not expose the underside of the print cartridge to direct light. Extended exposure to light may cause print quality problems.

Warning—Potential Damage: Do not touch the underside of the print cartridge. Doing so may affect the quality of future print jobs.



5 Insert the new print cartridge.

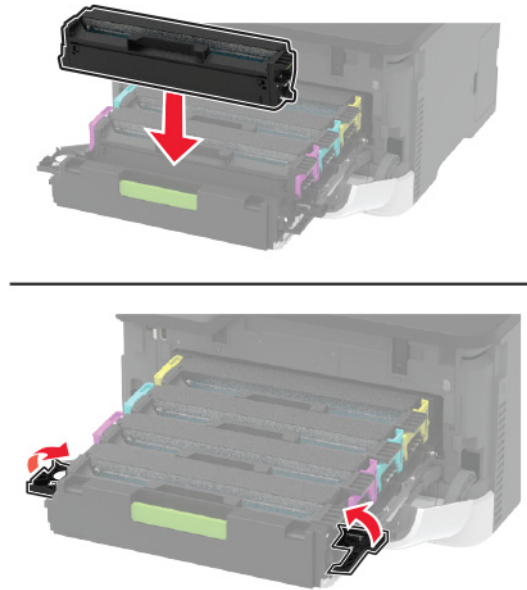

6 Insert the print cartridge tray, and then close the door.

Replacing the waste toner bottle

1 Remove the used waste toner bottle.



Note: To avoid spilling the toner, place the bottle in an upright position.

- 2 Unpack the new waste toner bottle.
- 3 Insert the new waste toner bottle.



Replacing the tray

- 1 Remove the used tray.



- 2 Unpack the new tray.
- 3 Insert the new tray.



Replacing the manual feeder

- 1 Remove the tray.



- 2 Remove the used manual feeder.



- 3 Unpack the new manual feeder.

- 4 Insert the new manual feeder.

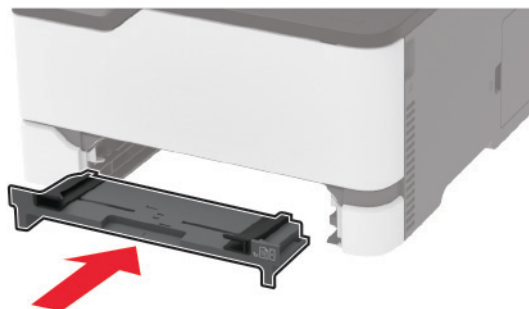

- 5 Insert the tray.

Replacing the pick tires

- 1 Turn off the printer.
- 2 Unplug the power cord from the electrical outlet, and then from the printer.

3 Open the front door, and then firmly push it down.

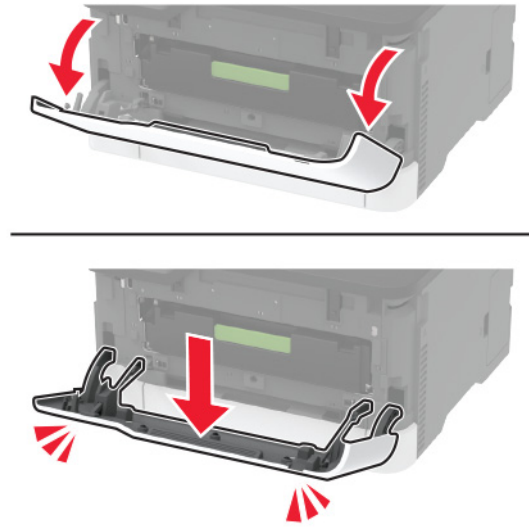

4 Pull out the print cartridge tray.



5 To avoid stray toner contamination, place a sheet of paper on the top of the print cartridge tray, and then insert the print cartridge tray.

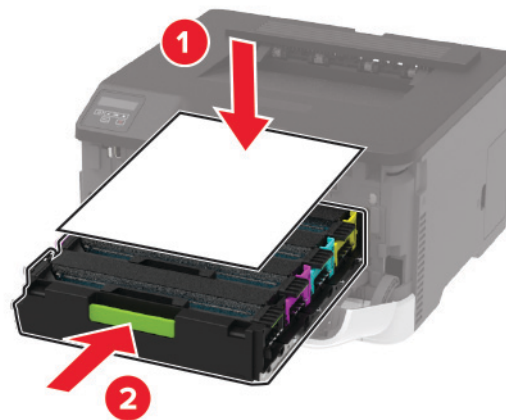

6 Close the front door.

7 Remove the tray.



8 Remove the waste toner bottle.

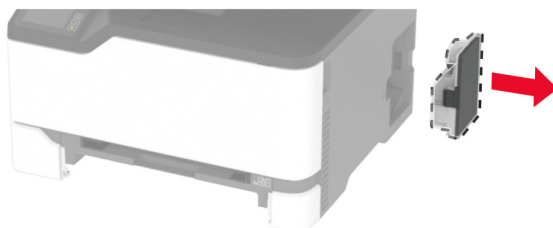

9 Position the printer on its side.



10 Remove the used pick tires.

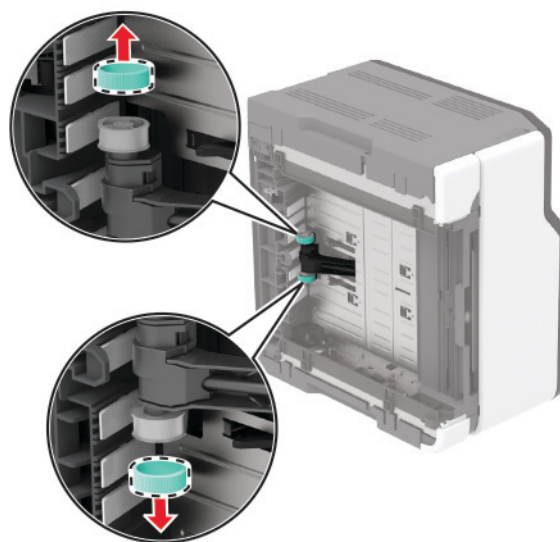
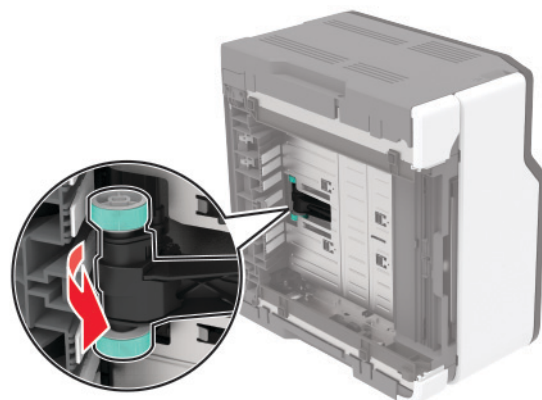

11 Unpack the new pick tires.

Note: To avoid contamination, make sure that your hands are clean.

- 12 Insert the new pick tires.

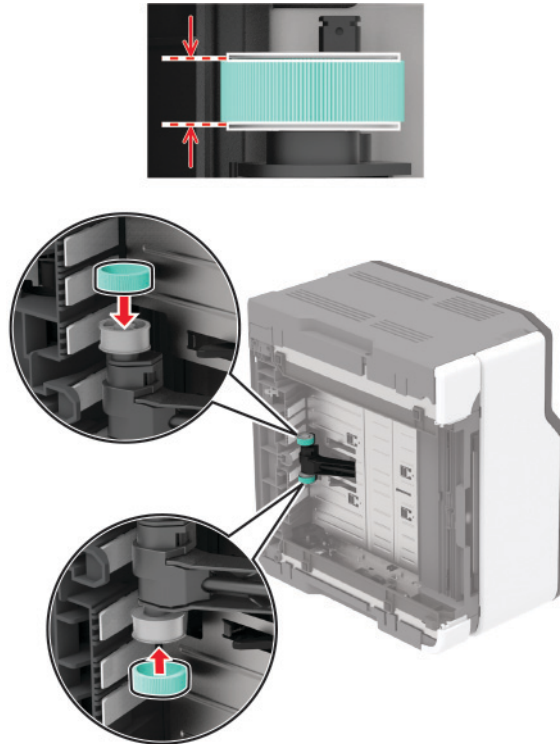

- 13 Return the printer to its original position, and then insert the waste toner bottle.
- 14 Insert the tray.
- 15 Open the front door, and then firmly push it down.
- 16 Pull out the print cartridge tray.
- 17 Remove the paper, and then insert the print cartridge tray.
- 18 Close the front door.
- 19 Connect the power cord to the printer, and then to the electrical outlet.

 **CAUTION—POTENTIAL INJURY:** To avoid the risk of fire or electrical shock, connect the power cord to an appropriately rated and properly grounded electrical outlet that is near the product and easily accessible.

- 20 Turn on the printer.

Resetting the supply usage counters

- 1 From the control panel, navigate to:

Settings > Device > Maintenance > Config Menu > Supply Usage And Counters

For non-touch-screen printer models, press  to navigate through the settings.

- 2 Select the supply counter that you want to reset.

Warning—Potential Damage: Supplies and parts without Return Program agreement terms may be reset and remanufactured. However, the manufacturer's warranty does not cover any damage caused by non-genuine supplies or parts. Resetting counters on the supply or part without proper remanufacturing can cause damage to your printer. After resetting the supply or part counter, your printer may display an error indicating the presence of the reset item.

Cleaning the printer

 **CAUTION—SHOCK HAZARD:** To avoid the risk of electrical shock when cleaning the exterior of the printer, unplug the power cord from the electrical outlet and disconnect all cables from the printer before proceeding.

Notes:

- Perform this task after every few months.
- Damage to the printer caused by improper handling is not covered by the printer warranty.

- 1 Turn off the printer, and then unplug the power cord from the electrical outlet.
- 2 Remove paper from the standard bin.
- 3 Remove any dust, lint, and pieces of paper around the printer using a soft brush or vacuum.
- 4 Wipe the outside of the printer with a damp, soft, lint-free cloth.

Notes:

- Do not use household cleaners or detergents, as they may damage the finish of the printer.
- Make sure that all areas of the printer are dry after cleaning.

- 5 Connect the power cord to the electrical outlet, and then turn on the printer.

 **CAUTION—POTENTIAL INJURY:** To avoid the risk of fire or electrical shock, connect the power cord to an appropriately rated and properly grounded electrical outlet that is near the product and easily accessible.

Saving energy and paper

Configuring the power save mode settings

Sleep mode

- 1 From the control panel, navigate to:

Settings > Device > Power Management > Timeouts > Sleep Mode

For non-touch-screen printer models, press  to navigate through the settings.

- 2 Specify the amount of time that the printer stays idle before it enters Sleep Mode.

Hibernate mode

1 From the control panel, navigate to:

Settings > Device > Power Management > Timeouts > Hibernate Timeout

For non-touch-screen printer models, press  to navigate through the settings.

2 Select the amount of time that the printer stays idle before it enters Hibernate mode.

Notes:

- For Hibernate Timeout to work, set Hibernate Timeout on Connection to Hibernate.
- The Embedded Web Server is disabled when the printer is in Hibernate mode.

Adjusting the brightness of the display

Note: This setting is available only in some printer models.

1 From the home screen, touch **Settings > Device > Preferences**.

2 In the Screen Brightness menu, adjust the setting.

Conserving supplies

- Print on both sides of the paper.

Note: Two-sided printing is the default setting in the print driver.

- Print multiple pages on a single sheet of paper.
- Use the preview feature to see how the document looks like before printing it.
- Print one copy of the document to check its content and format for accuracy.

Moving the printer to another location

 **CAUTION—POTENTIAL INJURY:** If the printer weight is greater than 20 kg (44 lb), then it may require two or more people to lift it safely.

 **CAUTION—POTENTIAL INJURY:** To avoid the risk of fire or electrical shock, use only the power cord provided with this product or the manufacturer's authorized replacement.

 **CAUTION—POTENTIAL INJURY:** When moving the printer, follow these guidelines to avoid personal injury or printer damage:

- Make sure that all doors and trays are closed.
- Turn off the printer, and then unplug the power cord from the electrical outlet.
- Disconnect all cords and cables from the printer.
- If the printer has separate floor-standing optional trays or output options attached to it, then disconnect them before moving the printer.
- If the printer has a caster base, then carefully roll it to the new location. Use caution when passing over thresholds and breaks in flooring.

- If the printer does not have a caster base but is configured with optional trays or output options, then remove the output options and lift the printer off the trays. Do not try to lift the printer and any options at the same time.
- Always use the handholds on the printer to lift it.
- Any cart used to move the printer must have a surface able to support the full footprint of the printer.
- Any cart used to move the hardware options must have a surface able to support the dimensions of the options.
- Keep the printer in an upright position.
- Avoid severe jarring movements.
- Make sure that your fingers are not under the printer when you set it down.
- Make sure that there is adequate clearance around the printer.

Note: Damage to the printer caused by improper moving is not covered by the printer warranty.

Shipping the printer

For shipping instructions, go to <http://support.lexmark.com> or contact customer support.

Troubleshoot a problem

The printer is not responding

Action	Yes	No
<p>Step 1 Check if the power cord is connected to the electrical outlet.</p> <p> CAUTION—POTENTIAL INJURY: To avoid the risk of fire or electrical shock, connect the power cord to an appropriately rated and properly grounded electrical outlet that is near the product and easily accessible.</p> <p>Is the printer responding?</p>	The problem is solved.	Go to step 2.
<p>Step 2 Check if the electrical outlet is turned off by a switch or breaker.</p> <p>Is the electrical outlet turned off by a switch or breaker?</p>	Turn on the switch or reset the breaker.	Go to step 3.
<p>Step 3 Check if the printer is on.</p> <p>Is the printer on?</p>	Go to step 4.	Turn on the printer.
<p>Step 4 Check if the printer is in Sleep or Hibernate mode.</p> <p>Is the printer in Sleep or Hibernate mode?</p>	Press the power button to wake the printer.	Go to step 5.
<p>Step 5 Check if the cables connecting the printer and the computer are inserted to the correct ports.</p> <p>Are the cables inserted to the correct ports?</p>	Go to step 6.	Insert the cables to the correct ports.
<p>Step 6 Turn off the printer, install the hardware options, and then turn on the printer. For more information, see the documentation that came with the option.</p> <p>Is the printer responding?</p>	The problem is solved.	Go to step 7.
<p>Step 7 Install the correct print driver.</p> <p>Is the printer responding?</p>	The problem is solved.	Go to step 8.

Action	Yes	No
<p>Step 8 Turn off the printer, wait for about 10 seconds, and then turn on the printer.</p> <p>Is the printer responding?</p>	<p>The problem is solved.</p>	<p>Contact customer support.</p>

Network connection problems

Cannot open Embedded Web Server

Action	Yes	No
<p>Step 1 Check if the printer is on.</p> <p>Is the printer on?</p>	<p>Go to step 2.</p>	<p>Turn on the printer.</p>
<p>Step 2 Make sure that the printer IP address is correct.</p> <p>Notes:</p> <ul style="list-style-type: none"> • View the IP address on the home screen. • An IP address appears as four sets of numbers separated by periods, such as 123.123.123.123. <p>Is the printer IP address correct?</p>	<p>Go to step 3.</p>	<p>Type the correct printer IP address in the address field.</p>
<p>Step 3 Check if you are using a supported browser:</p> <ul style="list-style-type: none"> • Internet Explorer version 11 or later • Microsoft Edge • Safari version 6 or later • Google Chrome™ version 32 or later • Mozilla Firefox version 24 or later <p>Is your browser supported?</p>	<p>Go to step 4.</p>	<p>Install a supported browser.</p>
<p>Step 4 Check if the network connection is working.</p> <p>Is the network connection working?</p>	<p>Go to step 5.</p>	<p>Contact your administrator.</p>

Action	Yes	No
<p>Step 5 Make sure that the cable connections to the printer and print server are secure. For more information, see the documentation that came with the printer.</p> <p>Are the cable connections secure?</p>	Go to step 6.	Secure the cable connections.
<p>Step 6 Check if the web proxy servers are disabled.</p> <p>Are the web proxy servers disabled?</p>	Go to step 7.	Contact your administrator.
<p>Step 7 Access the Embedded Web Server.</p> <p>Did the Embedded Web Server open?</p>	The problem is solved.	Contact customer support .

Issues with supplies

Replace cartridge, printer region mismatch

To correct this problem, purchase a cartridge with the correct region that matches the printer region, or purchase a worldwide cartridge.

- The first number in the message after 42 indicates the region of the printer.
- The second number in the message after 42 indicates the region of the cartridge.

Printer and print cartridge regions

Region	Numeric code
Worldwide or Undefined region	0
North America (United States, Canada)	1
European Economic Area, Western Europe, Nordic countries, Switzerland	2
Asia Pacific	3
Latin America	4
Rest of Europe, Middle East, Africa	5
Australia, New Zealand	6
Invalid region	9

Note: To find the region settings of the printer and print cartridge, print the Print Quality Test Pages. From the control panel, navigate to: **Settings > Troubleshooting > Print Quality Test Pages**.

Non-Lexmark supply

The printer has detected a non-Lexmark supply or part installed in the printer.

Your Lexmark printer is designed to function best with genuine Lexmark supplies and parts. Use of third-party supplies or parts may affect the performance, reliability, or life of the printer and its imaging components.

All life indicators are designed to function with Lexmark supplies and parts and may deliver unpredictable results if third-party supplies or parts are used. Imaging component usage beyond the intended life may damage your Lexmark printer or associated components.



Warning—Potential Damage: Use of third-party supplies or parts can affect warranty coverage. Damage caused by the use of third-party supplies or parts may not be covered by the warranty.

To accept any and all of these risks and to proceed with the use of non-genuine supplies or parts in your printer, do either of the following:

For touch-screen printer models, press  twice, and then press  twice.

For non-touch-screen printer models, press and hold **X** and  simultaneously for 15 seconds.

If you do not want to accept these risks, then remove the third-party supply or part from your printer and install a genuine Lexmark supply or part. For more information, see [“Using genuine Lexmark parts and supplies” on page 75](#).

For touch-screen printer models, if the printer does not print after pressing  twice, and then pressing  twice, then reset the supply usage counter.

For non-touch-screen printer models, if the printer does not print after pressing and holding **X** and  simultaneously for 15 seconds, then reset the supply usage counter.



1 From the control panel, navigate to:

Settings > Device > Maintenance > Config Menu > Supply Usage And Counters

For non-touch-screen printer models, press  to navigate through the settings.

2 Select the part or supply that you want to reset.

3 To clear the message, do either of the following:

- For touch-screen printer models, press  twice, and then press  twice.
- For non-touch-screen printer models, press and hold **X** and  simultaneously for 15 seconds.

Note: If you are unable to reset the supply usage counters, then return the item to the place of purchase.

Clearing jams

Avoiding jams

Load paper properly

- Make sure that the paper lies flat in the tray.

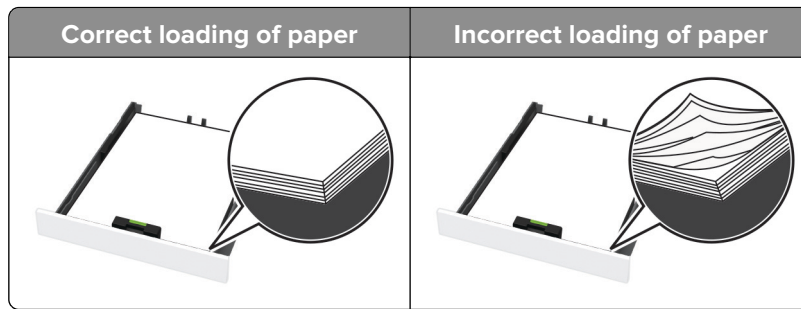

- Do not load or remove a tray while the printer is printing.
- Do not load too much paper. Make sure that the stack height is below the maximum paper fill indicator.
- Do not slide paper into the tray. Load paper as shown in the illustration.



- Make sure that the paper guides are positioned correctly and are not pressing tightly against the paper or envelopes.
- Push the tray firmly into the printer after loading paper.

Use recommended paper

- Use only recommended paper or specialty media.
- Do not load paper that is wrinkled, creased, damp, bent, or curled.
- Flex, fan, and align the paper edges before loading.

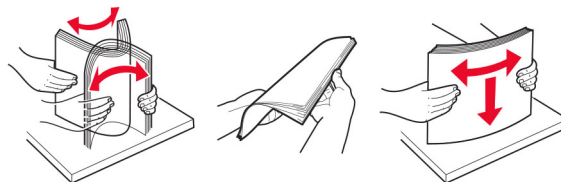

- Do not use paper that has been cut or trimmed by hand.
- Do not mix paper sizes, weights, or types in the same tray.
- Make sure that the paper size and type are set correctly on the computer or printer control panel.
- Store paper according to manufacturer recommendations.

Identifying jam locations

Notes:

- When Jam Assist is set to On, the printer might attempt to flush blank pages or pages with partial prints after a jammed page has been cleared. Check your printed output for blank pages.
- When Jam Recovery is set to On or Auto, the printer reprints jammed pages.

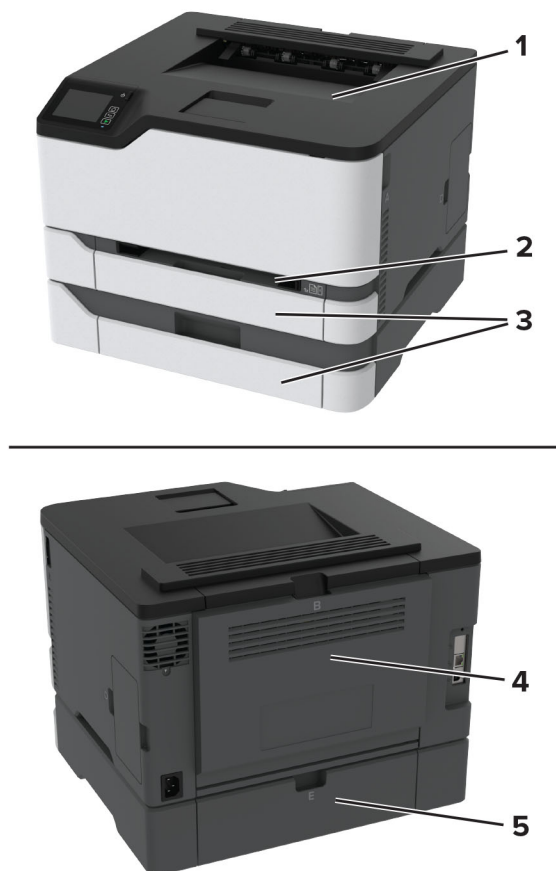

Jam locations	
1	Standard bin
2	Manual feeder
3	Trays
4	Door B
5	Door E

Paper jam in the standard tray

1 Open door B.

 **CAUTION—HOT SURFACE:** The inside of the printer might be hot. To reduce the risk of injury from a hot component, allow the surface to cool before touching it.

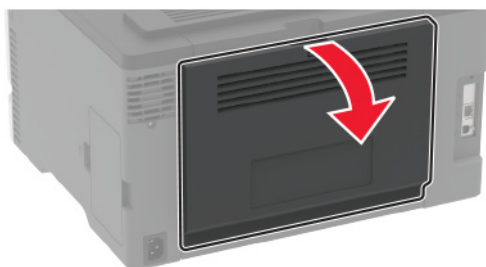

2 Remove the jammed paper.

Note: Make sure that all paper fragments are removed.

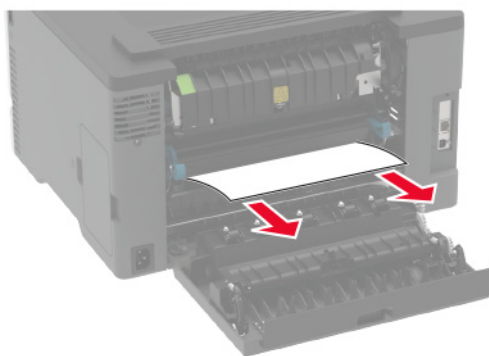

3 Close the door.

- 4 Remove the tray and the manual feeder.

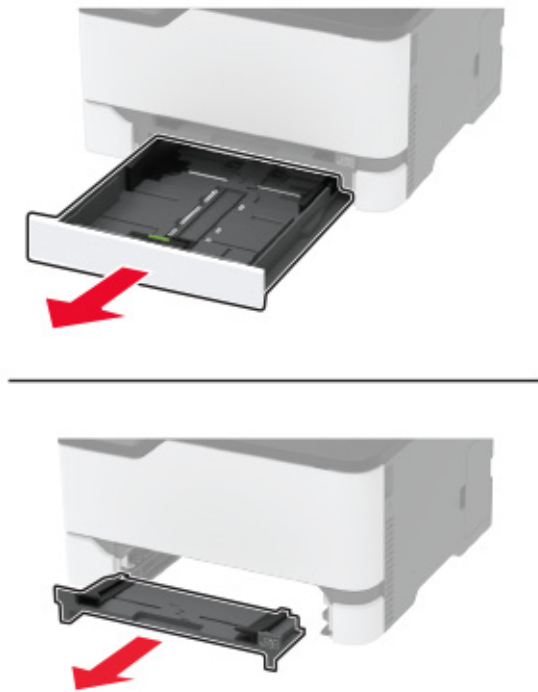

- 5 Remove the jammed paper.

Note: Make sure that all paper fragments are removed.

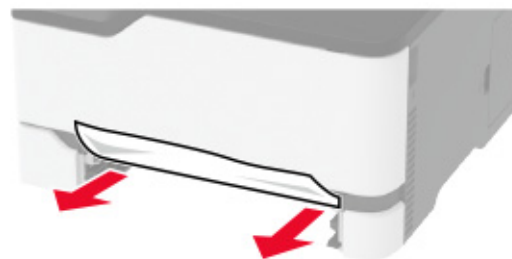

- 6 Insert the manual feeder and the tray.

Paper jam in the optional tray

- 1 Open door B.

 **CAUTION—HOT SURFACE:** The inside of the printer might be hot. To reduce the risk of injury from a hot component, allow the surface to cool before touching it.

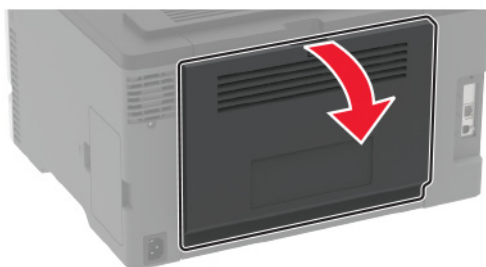

2 Remove the jammed paper.

Note: Make sure that all paper fragments are removed.

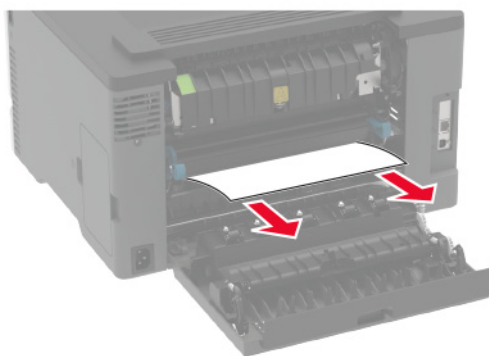

3 Close the door.

4 Open door E.

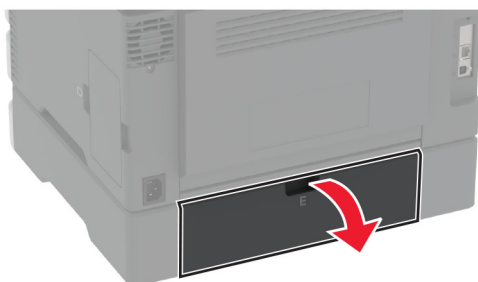

5 Remove the jammed paper.

Note: Make sure that all paper fragments are removed.

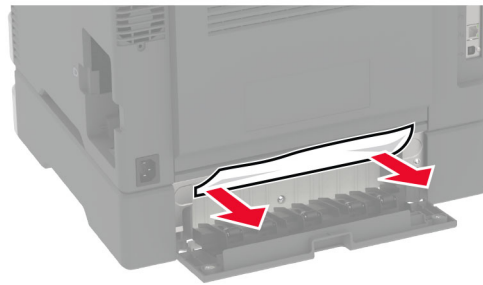

6 Close the door.

7 Remove the optional tray.



8 Remove the jammed paper.

Note: Make sure that all paper fragments are removed.

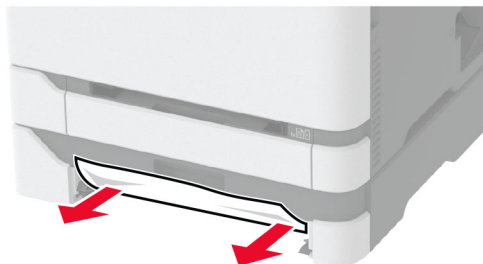

9 Insert the tray.

Paper jam in the standard bin

Remove the jammed paper.

Note: Make sure that all paper fragments are removed.



Paper jam in the manual feeder

- 1 Remove the tray and the manual feeder.

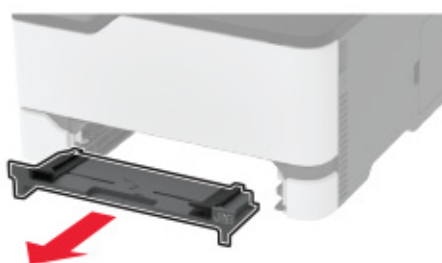

- 2 Remove the jammed paper.

Note: Make sure that all paper fragments are removed.

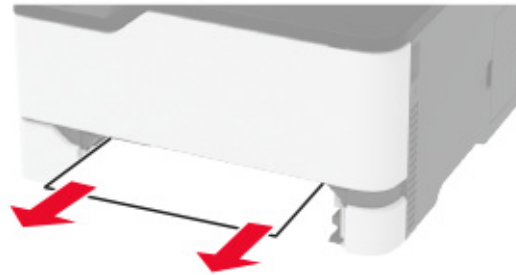

3 Insert the manual feeder and the tray.

Paper jam in door B

1 Open door B.

 **CAUTION—HOT SURFACE:** The inside of the printer might be hot. To reduce the risk of injury from a hot component, allow the surface to cool before touching it.

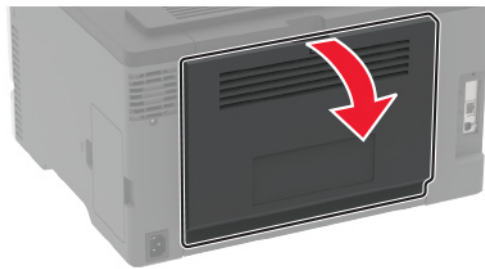

2 Remove the jammed paper from any of the following areas:

Note: Make sure that all paper fragments are removed.

- Fuser area

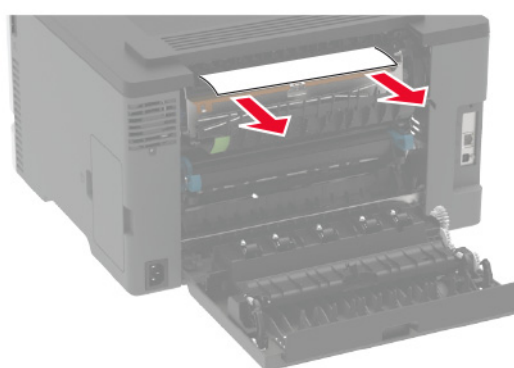
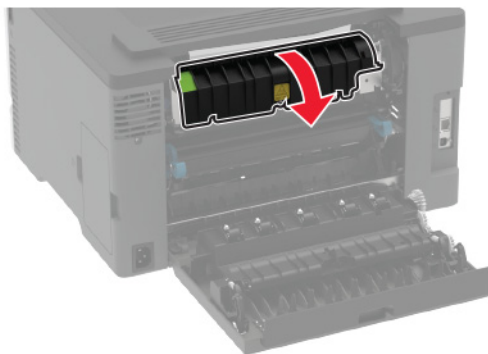

- Below the fuser area

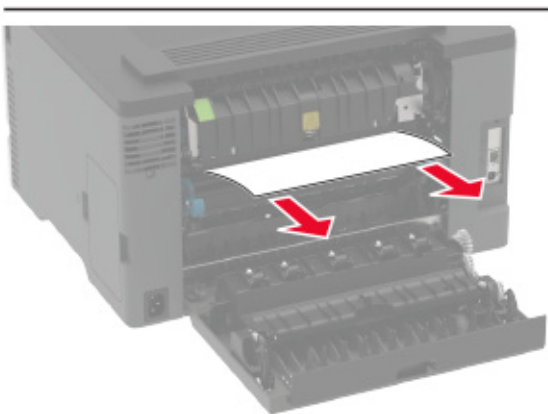
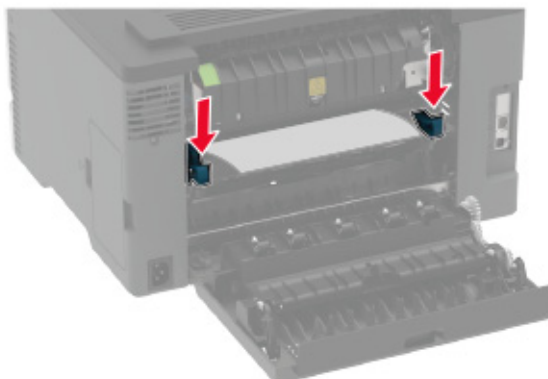

- Duplex unit

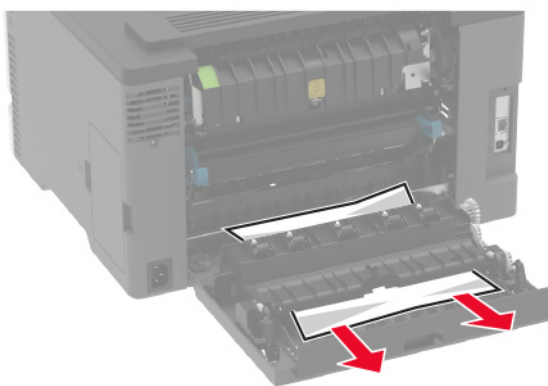

3 Close the door.

Paper feed problems

Envelope seals when printing

Action	Yes	No
<p>Step 1</p> <p>a Use an envelope that has been stored in a dry environment.</p> <p>Note: Printing on envelopes with high moisture content can seal the flaps.</p> <p>b Send the print job.</p> <p>Does the envelope seal when printing?</p>	Go to step 2.	The problem is solved.
<p>Step 2</p> <p>a Make sure that paper type is set to Envelope.</p> <p>From the control panel, navigate to:</p> <p>Settings > Paper > Tray Configuration > Paper Size/Type</p> <p>For non-touch-screen printer models, press  to navigate through the settings.</p> <p>b Send the print job.</p> <p>Does the envelope seal when printing?</p>	Contact customer support .	The problem is solved.

Collated printing does not work

Action	Yes	No
<p>Step 1</p> <p>a From the control panel, navigate to:</p> <p>Settings > Print > Layout > Collate</p> <p>For non-touch-screen printer models, press  to navigate through the settings.</p> <p>b Select On [1,2,1,2,1,2].</p> <p>c Print the document.</p> <p>Is the document collated correctly?</p>	The problem is solved.	Go to step 2.
<p>Step 2</p> <p>a From the document that you are trying to print, open the Print dialog, and then select Collate.</p> <p>b Print the document.</p> <p>Is the document collated correctly?</p>	The problem is solved.	Go to step 3.

Action	Yes	No
<p>Step 3</p> <p>a Reduce the number of pages to print.</p> <p>b Print the document.</p> <p>Are the pages collated correctly?</p>	The problem is solved.	Contact customer support .

Tray linking does not work

Action	Yes	No
<p>Step 1</p> <p>a Check if the trays contain the same paper size and paper type.</p> <p>b Check if the paper guides are positioned correctly.</p> <p>c Print the document.</p> <p>Do the trays link correctly?</p>	The problem is solved.	Go to step 2.
<p>Step 2</p> <p>a From the control panel, navigate to: Settings > Paper > Tray Configuration > Paper Size/Type</p> <p>For non-touch-screen printer models, press  to navigate through the settings.</p> <p>b Set the paper size and paper type to match the paper loaded in the linked trays.</p> <p>c Print the document.</p> <p>Do the trays link correctly?</p>	The problem is solved.	Go to step 3.
<p>Step 3</p> <p>a Make sure that Tray Linking is set to Automatic. For more information, see “Linking trays” on page 26.</p> <p>b Print the document.</p> <p>Do the trays link correctly?</p>	The problem is solved.	Contact customer support .

Paper frequently jams

Action	Yes	No
<p>Step 1</p> <p>a Remove the tray.</p> <p>b Check if paper is loaded correctly.</p> <p>Notes:</p> <ul style="list-style-type: none"> • Make sure that the paper guides are positioned correctly. • Make sure that the stack height is below the maximum paper fill indicator. • Make sure to print on recommended paper size and type. <p>c Insert the tray.</p> <p>d Print the document.</p> <p>Do paper jams occur frequently?</p>	Go to step 2.	The problem is solved.
<p>Step 2</p> <p>a From the control panel, navigate to: Settings > Paper > Tray Configuration > Paper Size/Type</p> <p>For non-touch-screen printer models, press  to navigate through the settings.</p> <p>b Set the correct paper size and type.</p> <p>c Print the document.</p> <p>Do paper jams occur frequently?</p>	Go to step 3.	The problem is solved.
<p>Step 3</p> <p>a Load paper from a fresh package.</p> <p>Note: Paper absorbs moisture due to high humidity. Store paper in its original wrapper until you are ready to use it.</p> <p>b Print the document.</p> <p>Do paper jams occur frequently?</p>	Contact customer support .	The problem is solved.

Jammed pages are not reprinted

Action	Yes	No
<p>a From the control panel, navigate to: Settings > Device > Notifications > Jam Content Recovery</p> <p>For non-touch-screen printer models, press  to navigate through the settings.</p> <p>b In the Jam Recovery menu, select On or Auto.</p> <p>c Print the document.</p> <p>Are the jammed pages reprinted?</p>	<p>The problem is solved.</p>	<p>Contact customer support.</p>

Printing problems

Print jobs do not print

Action	Yes	No
<p>Step 1</p> <p>a From the document you are trying to print, open the Print dialog, and then check if you have selected the correct printer.</p> <p>b Print the document.</p> <p>Is the document printed?</p>	<p>The problem is solved.</p>	<p>Go to step 2.</p>
<p>Step 2</p> <p>a Check if the printer is on.</p> <p>b Resolve any error messages that appear on the display.</p> <p>c Print the document.</p> <p>Is the document printed?</p>	<p>The problem is solved.</p>	<p>Go to step 3.</p>
<p>Step 3</p> <p>a Check if the ports are working and if the cables are securely connected to the computer and the printer.</p> <p>For more information, see the setup documentation that came with the printer.</p> <p>b Print the document.</p> <p>Is the document printed?</p>	<p>The problem is solved.</p>	<p>Go to step 4.</p>
<p>Step 4</p> <p>a Turn off the printer, wait for about 10 seconds, and then turn on the printer.</p> <p>b Print the document.</p> <p>Is the document printed?</p>	<p>The problem is solved.</p>	<p>Go to step 5.</p>

Action	Yes	No
<p>Step 5</p> <p>a Remove, and then reinstall the print driver.</p> <p>b Print the document.</p> <p>Is the document printed?</p>	The problem is solved.	Contact customer support .



Confidential and other held documents do not print

Action	Yes	No
<p>Step 1</p> <p>a From the control panel, check if the documents appear in the Held Jobs list.</p> <p>Note: If the documents are not listed, then print the documents using the Print and Hold options.</p> <p>b Print the documents.</p> <p>Are the documents printed?</p>	The problem is solved.	Go to step 2.
<p>Step 2</p> <p>The print job may contain a formatting error or invalid data. Delete the print job, and then send it again.</p> <p>Are the documents printed?</p>	The problem is solved.	Go to step 3.
<p>Step 3</p> <p>If you are printing from the Internet, then the printer may be reading the multiple job titles as duplicates.</p> <p>For Windows users</p> <p>a Open the Printing Preferences dialog.</p> <p>b From the Print and Hold tab, click Use Print and Hold, and then click Keep duplicate documents.</p> <p>c Enter a PIN, and then save the changes.</p> <p>d Send the print job.</p> <p>For Macintosh users</p> <p>a Save and name each job differently.</p> <p>b Send the job individually.</p> <p>Are the documents printed?</p>	The problem is solved.	Go to step 4.
<p>Step 4</p> <p>a Delete some held jobs to free up printer memory.</p> <p>b Print the documents.</p> <p>Are the documents printed?</p>	The problem is solved.	Contact customer support .

Job prints from the wrong tray or on the wrong paper

Action	Yes	No
<p>Step 1</p> <p>a Check if you are printing on the correct paper.</p> <p>b Print the document.</p> <p>Is the document printed on the correct paper?</p>	Go to step 2.	Load the correct paper size and paper type.
<p>Step 2</p> <p>a Depending on your operating system, specify the paper size and paper type from the Printing Preferences or Print dialog.</p> <p>Note: You can also change the settings on the printer control panel. Navigate to:</p> <p>Settings > Paper > Tray Configuration > Paper Size/Type</p> <p>For non-touch-screen printer models, press  to navigate through the settings.</p> <p>b Make sure that the settings match the paper loaded.</p> <p>c Print the document.</p> <p>Is the document printed on the correct paper?</p>	The problem is solved.	Go to step 3.
<p>Step 3</p> <p>a Check if the trays are linked.</p> <p>For more information, see “Linking trays” on page 26.</p> <p>b Print the document.</p> <p>Is the document printed from the correct tray?</p>	The problem is solved.	Contact customer support .

Slow printing

Action	Yes	No
<p>Step 1</p> <p>Make sure that the printer cable is securely connected to the printer and to the computer, print server, option, or other network device.</p> <p>Is the printer printing slow?</p>	Go to step 2.	The problem is solved.
<p>Step 2</p> <p>a Make sure that the printer is not in Quiet Mode.</p> <ul style="list-style-type: none"> From the control panel, navigate to: Settings > Device > Maintenance > Config Menu > Device Operations > Quiet Mode <p>For non-touch-screen printer models, press  to navigate through the settings.</p> <p>b Print the document.</p> <p>Is the printer printing slow?</p>	Go to step 3.	The problem is solved.
<p>Step 3</p> <p>a Depending on your operating system, specify the print resolution from the Printing Preferences or Print dialog.</p> <p>b Set the resolution to 4800 CQ.</p> <p>c Print the document.</p> <p>Is the printer printing slow?</p>	Go to step 4.	The problem is solved.
<p>Step 4</p> <p>a Depending on your operating system, specify the paper type from the Printing Preferences or Print dialog.</p> <p>Notes:</p> <ul style="list-style-type: none"> Make sure that the setting matches the paper loaded. You can also change the setting on the printer control panel. Navigate to Settings > Paper > Tray Configuration > Paper Size/Type. For non-touch-screen printer models, press  to navigate through the settings. Heavier paper prints more slowly. Paper narrower than letter, A4, and legal may print more slowly. <p>b Print the document.</p> <p>Is the printer printing slow?</p>	Go to step 5.	The problem is solved.

Action	Yes	No
<p>Step 5</p> <p>a Make sure that the printer settings for texture and weight match the paper being loaded.</p> <p>From the control panel, navigate to:</p> <p>Settings > Paper > Media Configuration > Media Types</p> <p>For non-touch-screen printer models, press  to navigate through the settings.</p> <p>Note: Rough paper textures and heavy paper weights may print more slowly.</p> <p>b Print the document.</p> <p>Is the printer printing slow?</p>	<p>Go to step 6.</p>	<p>The problem is solved.</p>
<p>Step 6</p> <p>Remove held jobs.</p> <p>Is the printer printing slow?</p>	<p>Go to step 7.</p>	<p>The problem is solved.</p>
<p>Step 7</p> <p>a Make sure that the printer is not overheating.</p> <p>Notes:</p> <ul style="list-style-type: none"> • Allow the printer to cool down after a long print job. • Observe the recommended ambient temperature for the printer. For more information, see “Selecting a location for the printer” on page 18. <p>b Print the document.</p> <p>Is the printer printing slow?</p>	<p>Contact customer support.</p>	<p>The problem is solved.</p>

Print quality problems

Print quality is poor

Find the image that resembles the print quality problem you are having, and then click the link below it to read problem-solving steps.

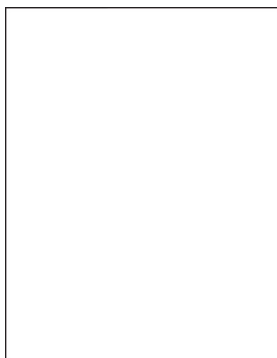

[“Blank or white pages” on page 113](#)

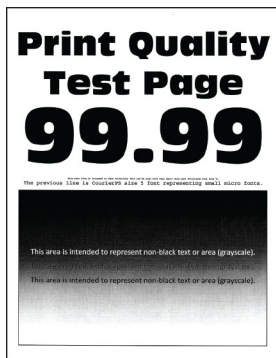

[“Dark print” on page 114](#)



[“Ghost images” on page 116](#)

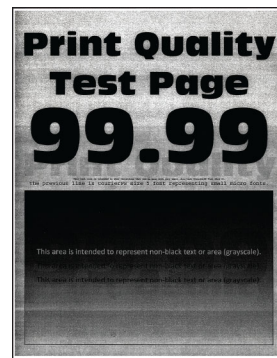

[“Gray or colored background” on page 117](#)



[“Incorrect margins” on page 118](#)

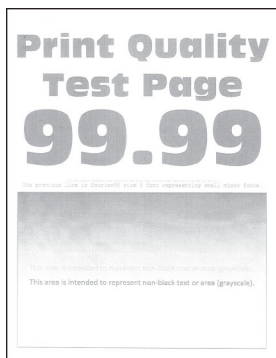

[“Light print” on page 119](#)

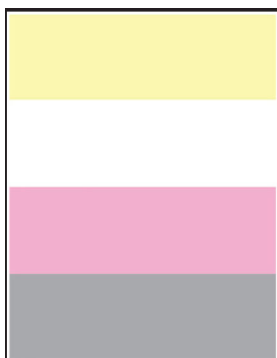

[“Missing colors” on page 121](#)



[“Mottled print and dots” on page 122](#)



[“Paper curl” on page 124](#)



[“Print crooked or skewed” on page 126](#)



[“Solid color or black images” on page 126](#)

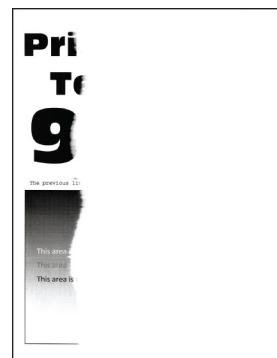

[“Text or images cut off” on page 127](#)



[“Toner easily rubs off” on page 128](#)

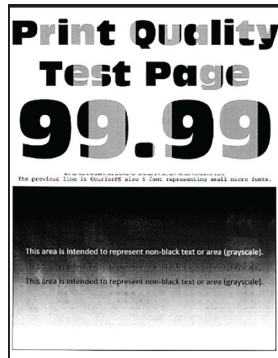

[“Uneven print density” on page 129](#)

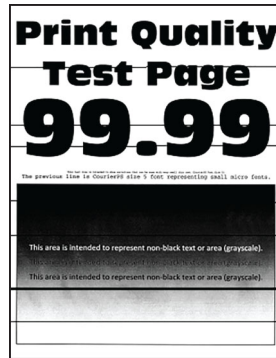

[“Horizontal dark lines” on page 130](#)



[“Vertical dark lines” on page 132](#)

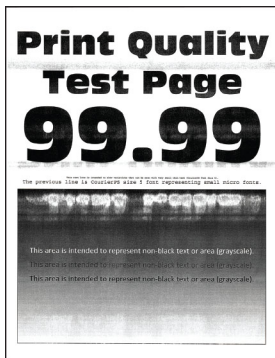

[“Horizontal white lines” on page 133](#)

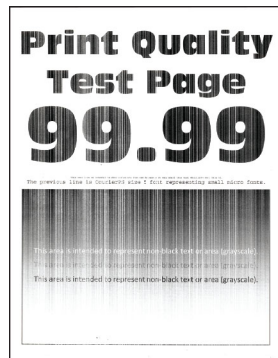

[“Vertical white lines” on page 134](#)

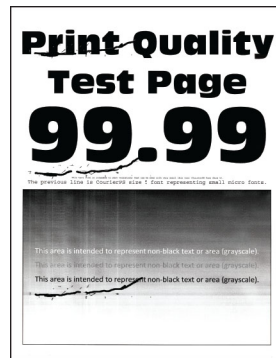

[“Repeating defects” on page 136](#)

Blank or white pages



Note: Before solving the problem, print the Print Quality Test Pages. From the control panel, navigate to

Settings > Troubleshooting > Print Quality Test Pages. For non-touch-screen printer models, press  to navigate through the settings.

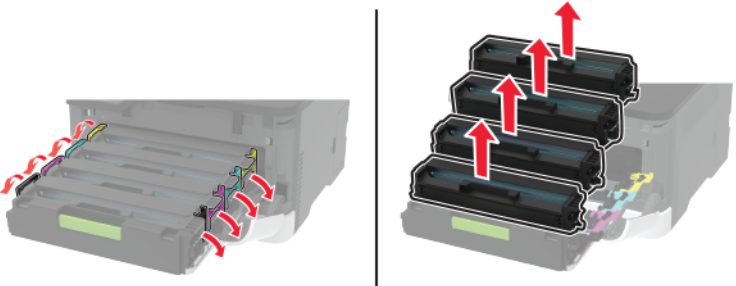
Action	Yes	No
<p>a Open the front door, and then firmly push it down. b Pull out the print cartridge tray. c Remove, and then insert the print cartridges.</p>  <p>d Insert the print cartridge tray, and then close the door. e Print the document.</p> <p>Is the printer printing blank or white pages?</p>	<p>Contact customer support.</p>	<p>The problem is solved.</p>

Dark print

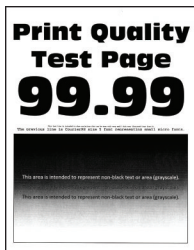

Note: Before solving the problem, print the Print Quality Test Pages. From the control panel, navigate to

Settings > Troubleshooting > Print Quality Test Pages. For non-touch-screen printer models, press  to navigate through the settings.

Action	Yes	No
<p>Step 1</p> <p>a Perform Color Adjust. From the control panel, navigate to: Settings > Print > Quality > Advanced Imaging > Color Adjust</p> <p>b Print the document.</p> <p>Is the print too dark?</p>	<p>Go to step 2.</p>	<p>The problem is solved.</p>

Action	Yes	No
<p>Step 2</p> <p>a Depending on your operating system, reduce toner darkness from the Printing Preferences or Print dialog.</p> <p>Note: You can also change the setting on the printer control panel. Navigate to:</p> <p>Settings > Print > Quality > Toner Darkness</p> <p>b Print the document.</p> <p>Is the print too dark?</p>	<p>Go to step 3.</p>	<p>The problem is solved.</p>
<p>Step 3</p> <p>a Depending on your operating system, specify the paper type from the Printing Preferences or Print dialog.</p> <p>Notes:</p> <ul style="list-style-type: none"> • Make sure that the setting matches the paper loaded. • You can also change the setting on the printer control panel. Navigate to: <p>Settings > Paper > Tray Configuration > Paper Size/Type</p> <p>b Print the document.</p> <p>Is the print too dark?</p>	<p>Go to step 4.</p>	<p>The problem is solved.</p>
<p>Step 4</p> <p>Check if the paper has texture or rough finishes.</p> <p>Are you printing on textured or rough paper?</p>	<p>Go to step 5.</p>	<p>Go to step 6.</p>
<p>Step 5</p> <p>a Replace textured or rough paper with plain paper.</p> <p>b Print the document.</p> <p>Is the print too dark?</p>	<p>Go to step 6.</p>	<p>The problem is solved.</p>
<p>Step 6</p> <p>a Load paper from a fresh package.</p> <p>Note: Paper absorbs moisture due to high humidity. Store paper in its original wrapper until you are ready to use it.</p> <p>b Print the document.</p> <p>Is the print too dark?</p>	<p>Contact customer support.</p>	<p>The problem is solved.</p>

Ghost images

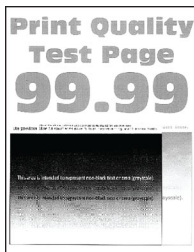

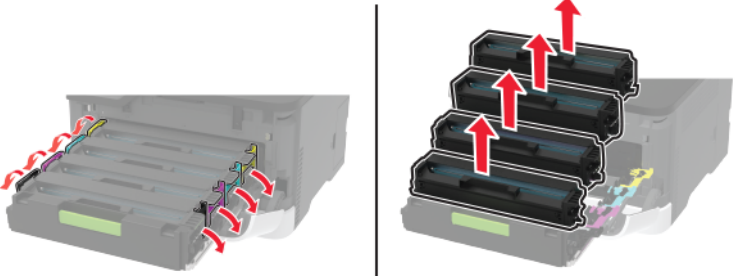

Note: Before solving the problem, print the Print Quality Test Pages. From the control panel, navigate to **Settings > Troubleshooting > Print Quality Test Pages**. For non-touch-screen printer models, press **OK** to navigate through the settings.

Action	Yes	No
<p>Step 1</p> <p>a Load the tray with the correct paper type.</p> <p>b Print the document.</p> <p>Do ghost images appear on prints?</p>	Go to step 2.	The problem is solved.
<p>Step 2</p> <p>a Depending on your operating system, specify the paper type from the Printing Preferences or Print dialog.</p> <p>Notes:</p> <ul style="list-style-type: none"> • Make sure that the setting matches the paper loaded. • You can also change the setting on the printer control panel. Navigate to Settings > Paper > Tray Configuration > Paper Size/Type. <p>b Print the document.</p> <p>Do ghost images appear on prints?</p>	Go to step 3.	The problem is solved.
<p>Step 3</p> <p>a Perform Color Adjust.</p> <p>From the control panel, navigate to:</p> <p>Settings > Print > Quality > Advanced Imaging > Color Adjust.</p> <p>b Print the document.</p> <p>Do ghost images appear on prints?</p>	Go to step 4.	The problem is solved.

Action	Yes	No
<p>Step 4</p> <p>a Open the front door, and then firmly push it down.</p> <p>b Pull out the print cartridge tray.</p> <p>c Remove, and then insert the print cartridges.</p>  <p>d Insert the print cartridge tray, and then close the door.</p> <p>e Print the document.</p> <p>Do ghost images appear on prints?</p>	<p>Contact customer support.</p>	<p>The problem is solved.</p>

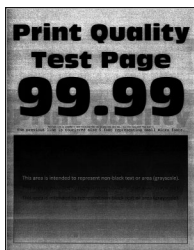
Gray or colored background



Note: Before solving the problem, print the Print Quality Test Pages. From the control panel, navigate to **Settings > Troubleshooting > Print Quality Test Pages**. For non-touch-screen printer models, press  to navigate through the settings.

Action	Yes	No
<p>Step 1</p> <p>a Perform Color Adjust. From the control panel, navigate to: Settings > Print > Quality > Advanced Imaging > Color Adjust.</p> <p>b Print the document.</p> <p>Does gray or colored background appear on prints?</p>	<p>Go to step 2.</p>	<p>The problem is solved.</p>

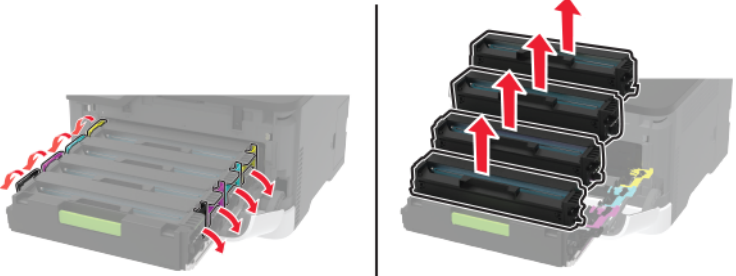
Action	Yes	No
<p>Step 2</p> <p>a Open the front door, and then firmly push it down.</p> <p>b Pull out the print cartridge tray.</p> <p>c Remove, and then insert the print cartridges.</p>  <p>d Insert the print cartridge tray, and then close the door.</p> <p>e Print the document.</p> <p>Does gray or colored background appear on prints?</p>	<p>Contact customer support.</p>	<p>The problem is solved.</p>

Incorrect margins





Note: Before solving the problem, print the Print Quality Test Pages. From the control panel, navigate to **Settings > Troubleshooting > Print Quality Test Pages**. For non-touch-screen printer models, press  to navigate through the settings.

Action	Yes	No
<p>Step 1</p> <p>a Adjust the paper guides to the correct position for the paper loaded.</p> <p>b Print the document.</p> <p>Are the margins correct?</p>	<p>The problem is solved.</p>	<p>Go to step 2.</p>

Action	Yes	No
<p>Step 2</p> <p>a Depending on your operating system, specify the paper size from the Printing Preferences or Print dialog.</p> <p>Notes:</p> <ul style="list-style-type: none"> • Make sure that the setting matches the paper loaded. • You can also change the setting from the printer control panel. Navigate to Settings > Paper > Tray Configuration > Paper Size/Type. <p>b Print the document.</p> <p>Are the margins correct?</p>	<p>The problem is solved.</p>	<p>Contact customer support.</p>

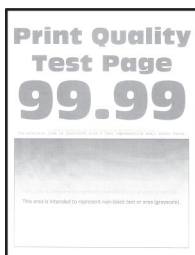
Light print



Note: Before solving the problem, print the Print Quality Test Pages. From the control panel, navigate to **Settings > Troubleshooting > Print Quality Test Pages**. For non-touch-screen printer models, press  to navigate through the settings.

Action	Yes	No
<p>Step 1</p> <p>a Perform Color Adjust. From the control panel, navigate to: Settings > Print > Quality > Advanced Imaging > Color Adjust.</p> <p>b Print the document.</p> <p>Is the print light?</p>	<p>Go to step 2.</p>	<p>The problem is solved.</p>
<p>Step 2</p> <p>a Depending on your operating system, increase toner darkness from the Printing Preferences or Print dialog. Note: You can also change the setting on the printer control panel. Navigate to Settings > Print > Quality > Toner Darkness.</p> <p>b Print the document.</p> <p>Is the print light?</p>	<p>Go to step 3.</p>	<p>The problem is solved.</p>

Action	Yes	No
<p>Step 3</p> <p>a Depending on your operating system, specify the paper type from the Printing Preferences or Print dialog.</p> <p>Notes:</p> <ul style="list-style-type: none"> • Make sure that the setting matches the paper loaded. • You can also change the setting on the printer control panel. Navigate to Settings > Paper > Tray Configuration > Paper Size/Type. <p>b Print the document.</p> <p>Is the print light?</p>	<p>Go to step 4.</p>	<p>The problem is solved.</p>
<p>Step 4</p> <p>Check if paper has texture or rough finishes.</p> <p>Are you printing on textured or rough paper?</p>	<p>Go to step 5.</p>	<p>Go to step 7.</p>
<p>Step 5</p> <p>a Replace textured or rough paper with plain paper.</p> <p>b Print the document.</p> <p>Is the print light?</p>	<p>Go to step 7.</p>	<p>The problem is solved.</p>
<p>Step 6</p> <p>a Load paper from a fresh package.</p> <p>Note: Paper absorbs moisture due to high humidity. Store paper in its original wrapper until you are ready to use it.</p> <p>b Print the document.</p> <p>Is the print light?</p>	<p>Go to step 7.</p>	<p>The problem is solved.</p>

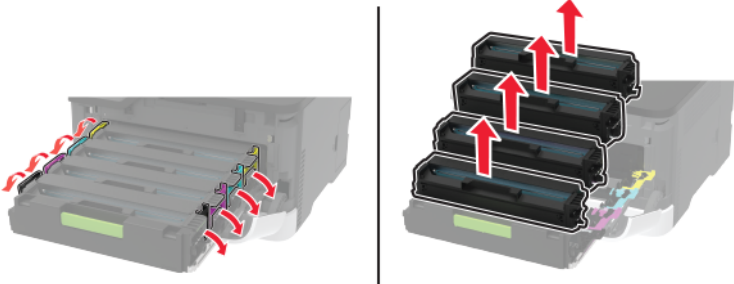
Action	Yes	No
<p>Step 7</p> <ul style="list-style-type: none"> a Open the front door, and then firmly push it down. b Pull out the print cartridge tray. c Remove, and then insert the print cartridges.  <ul style="list-style-type: none"> d Insert the print cartridge tray, and then close the door. e Print the document. <p>Is the print light?</p>	<p>Contact customer support.</p>	<p>The problem is solved.</p>

Missing colors

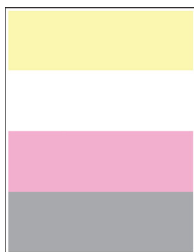

Note: Before solving the problem, print the Print Quality Test Pages. From the control panel, navigate to **Settings > Troubleshooting > Print Quality Test Pages**. For non-touch-screen printer models, press  to navigate through the settings.

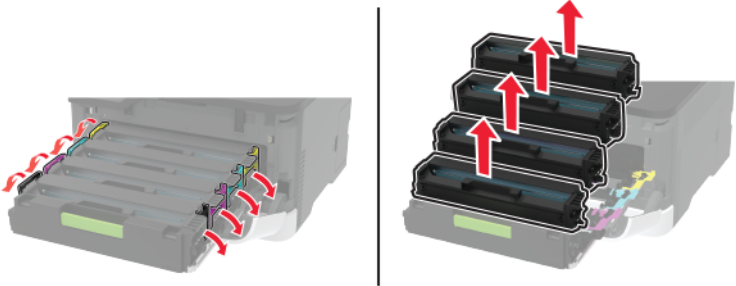
Action	Yes	No
<p> a Open the front door, and then firmly push it down. b Pull out the print cartridge tray. c Remove, and then insert the print cartridge of the missing color. </p> <div style="text-align: center;">  </div> <p> d Insert the print cartridge tray, and then close the door. e Print the document. </p> <p>Are some colors missing on prints?</p>	<p>Contact customer support.</p>	<p>The problem is solved.</p>

Mottled print and dots



Note: Before solving the problem, print the Print Quality Test Pages. From the control panel, navigate to **Settings > Troubleshooting > Print Quality Test Pages**. For non-touch-screen printer models, press  to navigate through the settings.

Action	Yes	No
<p>Step 1 Check the printer for leaked toner contamination.</p> <p>Is the printer free of leaked toner?</p>	Go to step 2.	Contact customer support .
<p>Step 2 a From the control panel, navigate to: Settings > Paper > Tray Configuration > Paper Size/Type b Check if the paper size and paper type settings match the paper loaded. Note: Make sure that paper does not have texture or rough finishes.</p> <p>Do the settings match?</p>	Go to step 4.	Go to step 3.
<p>Step 3 a Depending on your operating system, specify the paper size and paper type from the Printing Preferences or Print dialog. Note: Make sure that the settings match the paper loaded. b Print the document.</p> <p>Is the print mottled?</p>	Go to step 4.	The problem is solved.
<p>Step 4 a Load paper from a fresh package. Note: Paper absorbs moisture due to high humidity. Store paper in its original wrapper until you are ready to use it. b Print the document.</p> <p>Is the print mottled?</p>	Go to step 5.	The problem is solved.

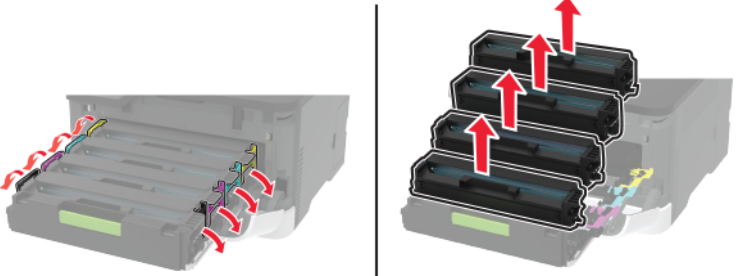
Action	Yes	No
<p>Step 5</p> <p>a Open the front door, and then firmly push it down.</p> <p>b Pull out the print cartridge tray.</p> <p>c Remove, and then insert the print cartridges.</p>  <p>d Insert the print cartridge tray, and then close the door.</p> <p>e Print the document.</p> <p>Is the print mottled?</p>	<p>Contact customer support.</p>	<p>The problem is solved.</p>

Paper curl



Note: Before solving the problem, print the Print Quality Test Pages. From the control panel, navigate to **Settings > Troubleshooting > Print Quality Test Pages**. For non-touch-screen printer models, press  to navigate through the settings.

Action	Yes	No
<p>Step 1</p> <p>a Check if the paper loaded is supported. Note: If paper is not supported, then load a supported paper.</p> <p>b Print the document.</p> <p>Is the paper curled?</p>	<p>Go to step 2.</p>	<p>The problem is solved.</p>

Action	Yes	No
<p>Step 2</p> <p>a Check if the printer is using a genuine and supported Lexmark toner cartridge.</p> <p>Note: If the cartridge is not supported, then install a supported one.</p> <p>b Print the document.</p> <p>Is the paper curled?</p>	Go to step 3.	The problem is solved.
<p>Step 3</p> <p>a Adjust the guides in the tray to the correct position for the paper loaded.</p> <p>b Print the document.</p> <p>Is the paper curled?</p>	Go to step 4.	The problem is solved.
<p>Step 4</p> <p>a Depending on your operating system, specify the paper size and paper type from the Printing Preferences or Print dialog.</p> <p>Notes:</p> <ul style="list-style-type: none"> • Make sure that the settings match the paper loaded. • You can also change the setting on the printer control panel. Navigate to Settings > Paper > Tray Configuration > Paper Size/Type. <p>b Print the document.</p> <p>Is the paper curled?</p>	Go to step 5.	The problem is solved.
<p>Step 5</p> <p>a Remove paper, flip it over, and then reload paper.</p> <p>b Print the document.</p> <p>Is the paper curled?</p>	Go to step 6.	The problem is solved.
<p>Step 6</p> <p>a Load paper from a fresh package.</p> <p>Note: Paper absorbs moisture due to high humidity. Store paper in its original wrapper until you are ready to use it.</p> <p>b Print the document.</p> <p>Is the paper curled?</p>	Contact customer support .	The problem is solved.

Print crooked or skewed

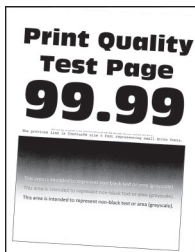

Note: Before solving the problem, print the Print Quality Test Pages. From the control panel, navigate to **Settings > Troubleshooting > Print Quality Test Pages**. For non-touch-screen printer models, press **OK** to navigate through the settings.

Action	Yes	No
<p>Step 1</p> <p>a Adjust the paper guides in the tray to the correct position for the paper loaded.</p> <p>b Print the document.</p> <p>Is the print crooked or skewed?</p>	Go to step 2.	The problem is solved.
<p>Step 2</p> <p>a Load paper from a fresh package.</p> <p>Note: Paper absorbs moisture due to high humidity. Store paper in its original wrapper until you are ready to use it.</p> <p>b Print the document.</p> <p>Is the print crooked or skewed?</p>	Go to step 3.	The problem is solved.
<p>Step 3</p> <p>a Check if the paper loaded is supported.</p> <p>Note: If paper is not supported, then load a supported paper.</p> <p>b Print the document.</p> <p>Is the print crooked or skewed?</p>	Contact customer support .	The problem is solved.

Solid color or black images

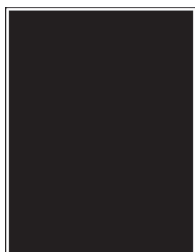

Note: Before solving the problem, print the Print Quality Test Pages. From the control panel, navigate to **Settings > Troubleshooting > Print Quality Test Pages**. For non-touch-screen printer models, press **OK** to navigate through the settings.

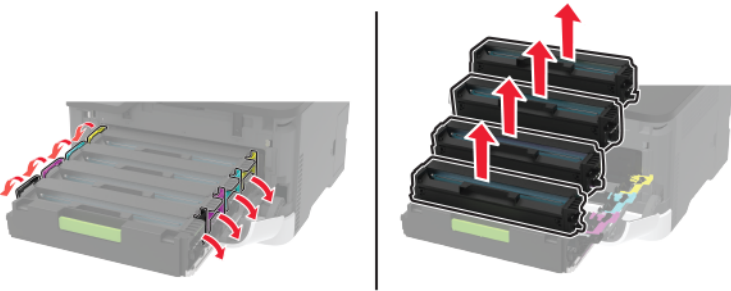
Action	Yes	No
<p>a Open the front door, and then firmly push it down. b Pull out the print cartridge tray. c Remove, and then insert the print cartridges.</p>  <p>d Insert the print cartridge tray, and then close the door. e Print the document.</p> <p>Is the printer printing solid color or black images?</p>	<p>Contact customer support.</p>	<p>The problem is solved.</p>

Text or images cut off





Note: Before solving the problem, print the Print Quality Test Pages. From the control panel, navigate to **Settings > Troubleshooting > Print Quality Test Pages**. For non-touch-screen printer models, press **OK** to navigate through the settings.

Action	Yes	No
<p>Step 1</p> <p>a Adjust the paper guides in the tray to the correct position for the paper loaded. b Print the document.</p> <p>Are text or images cut off?</p>	<p>Go to step 2.</p>	<p>The problem is solved.</p>

Action	Yes	No
<p>Step 2</p> <p>a Depending on your operating system, specify the paper size from the Printing Preferences or Print dialog.</p> <p>Notes:</p> <ul style="list-style-type: none"> • Make sure that the setting matches the paper loaded. • You can also change the setting on the printer control panel. Navigate to Settings > Paper > Tray Configuration > Paper Size/Type. <p>b Print the document.</p> <p>Are text or images cut off?</p>	<p>Go to step 3.</p>	<p>The problem is solved.</p>
<p>Step 3</p> <p>a Open the front door, and then firmly push it down.</p> <p>b Pull out the print cartridge tray.</p> <p>c Remove, and then insert the print cartridges.</p> <div data-bbox="215 905 946 1188" data-label="Image"> </div> <p>d Insert the print cartridge tray, and then close the door.</p> <p>e Print the document.</p> <p>Are text or images cut off?</p>	<p>Contact customer support.</p>	<p>The problem is solved.</p>

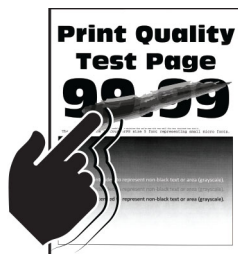
Toner easily rubs off



Note: Before solving the problem, print the Print Quality Test Pages. From the control panel, navigate to **Settings > Troubleshooting > Print Quality Test Pages**. For non-touch-screen printer models, press  to navigate through the settings.

Action	Yes	No
<p>Step 1</p> <p>a Depending on your operating system, specify the paper type from the Printing Preferences or Print dialog.</p> <p>Notes:</p> <ul style="list-style-type: none"> • Make sure that the setting matches the paper loaded. • You can also change the setting on the printer control panel. Navigate to: <p>Settings > Paper > Tray Configuration > Paper Size/Type</p> <p>b Print the document.</p> <p>Does toner easily rub off?</p>	Go to step 2.	The problem is solved.
<p>Step 2</p> <p>a Check if the paper weight is supported.</p> <p>Note: If paper weight is not supported, then load a supported one.</p> <p>b Print the document.</p> <p>Does toner easily rub off?</p>	Go to step 3.	The problem is solved.
<p>Step 3</p> <p>a Load paper from a fresh package.</p> <p>Note: Paper absorbs moisture due to high humidity. Store paper in its original wrapper until you are ready to use it.</p> <p>b Print the document.</p> <p>Does toner easily rub off?</p>	Contact customer support .	The problem is solved.

Uneven print density

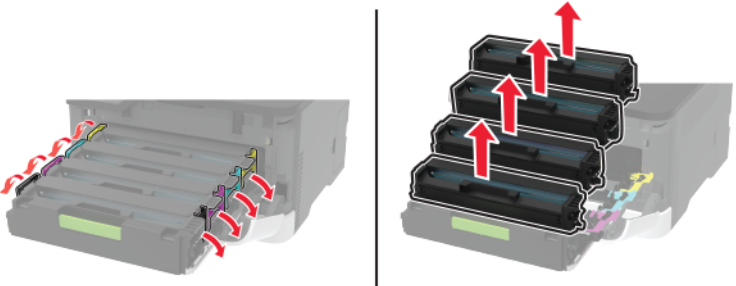

Note: Before solving the problem, print the Print Quality Test Pages. From the control panel, navigate to **Settings > Troubleshooting > Print Quality Test Pages**. For non-touch-screen printer models, press  to navigate through the settings.

Action	Yes	No
<p>a Open the front door, and then firmly push it down. b Pull out the print cartridge tray. c Remove, and then insert the print cartridges.</p>  <p>d Insert the print cartridge tray, and then close the door. e Print the document.</p> <p>Is the print density uneven?</p>	<p>Contact customer support.</p>	<p>The problem is solved.</p>

Horizontal dark lines



Notes:

- Before solving the problem, print the Print Quality Test Pages. From the control panel, navigate to **Settings > Troubleshooting > Print Quality Test Pages**. For non-touch-screen printer models, press  to navigate through the settings.
- If horizontal dark lines keep appearing on the prints, then see the “Repeating defects” topic.

Action	Yes	No
<p>Step 1</p> <p>a Depending on your operating system, specify the paper type from the Printing Preferences or Print dialog.</p> <p>Notes:</p> <ul style="list-style-type: none"> • Make sure that the setting matches the paper loaded. • You can also change the setting on the printer control panel. Navigate to Settings > Paper > Tray Configuration > Paper Size/Type. <p>b Print the document.</p> <p>Do dark lines appear on prints?</p>	<p>Go to step 2.</p>	<p>The problem is solved.</p>
<p>Step 2</p> <p>a Load paper from a fresh package.</p> <p>Note: Paper absorbs moisture due to high humidity. Store paper in its original wrapper until you use it.</p> <p>b Print the document.</p> <p>Do dark lines appear on prints?</p>	<p>Go to step 3.</p>	<p>The problem is solved.</p>
<p>Step 3</p> <p>a Open the front door, and then firmly push it down.</p> <p>b Pull out the print cartridge tray.</p> <p>c Remove, and then insert the print cartridges.</p> <div data-bbox="217 1192 945 1478" data-label="Image"> </div> <p>d Insert the print cartridge tray, and then close the door.</p> <p>e Print the document.</p> <p>Do dark lines appear on prints?</p>	<p>Contact customer support.</p>	<p>The problem is solved.</p>

Vertical dark lines



Note: Before solving the problem, print the Print Quality Test Pages. From the control panel, navigate to **Settings > Troubleshooting > Print Quality Test Pages**. For non-touch-screen printer models, press **OK** to navigate through the settings.

Action	Yes	No
<p>Step 1</p> <p>a Depending on your operating system, specify the paper type from the Printing Preferences or Print dialog.</p> <p>Notes:</p> <ul style="list-style-type: none"> • Make sure that the setting matches the paper loaded. • You can also change the setting on the printer control panel. Navigate to Settings > Paper > Tray Configuration > Paper Size/Type. <p>b Print the document.</p> <p>Do vertical dark lines appear on prints?</p>	Go to step 2.	The problem is solved.
<p>Step 2</p> <p>a Load paper from a fresh package.</p> <p>Note: Paper absorbs moisture due to high humidity. Store paper in its original wrapper until you use it.</p> <p>b Print the document.</p> <p>Do vertical dark lines appear on prints?</p>	Go to step 3.	The problem is solved.

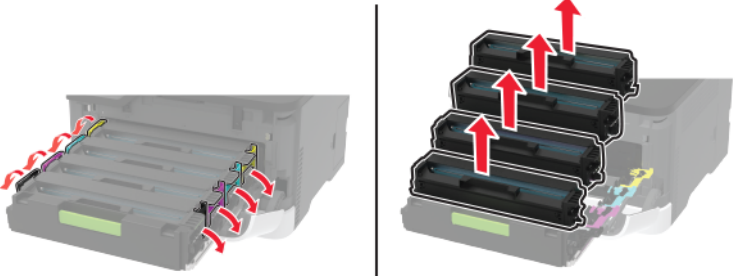
Action	Yes	No
<p>Step 3</p> <p>a Open the front door, and then firmly push it down.</p> <p>b Pull out the print cartridge tray.</p> <p>c Remove, and then insert the print cartridges.</p>  <p>d Insert the print cartridge tray, and then close the door.</p> <p>e Print the document.</p> <p>Do vertical dark lines appear on prints?</p>	<p>Contact customer support.</p>	<p>The problem is solved.</p>

Horizontal white lines

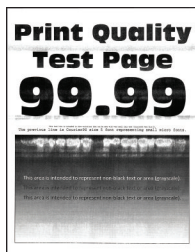

Notes:

- Before solving the problem, print the Print Quality Test Pages. From the control panel, navigate to **Settings > Troubleshooting > Print Quality Test Pages**. For non-touch-screen printer models, press  to navigate through the settings.
- If horizontal white lines keep appearing on your prints, then see the “Repeating defects” topic.

Action	Yes	No
<p>Step 1</p> <p>a Depending on your operating system, specify the paper type from the Printing Preferences or Print dialog.</p> <p>Notes:</p> <ul style="list-style-type: none"> • Make sure that the setting matches the paper loaded. • You can also change the setting on the printer control panel. Navigate to Settings > Paper > Tray Configuration > Paper Size/Type. <p>b Print the document.</p> <p>Do horizontal white lines appear on prints?</p>	<p>Go to step 2.</p>	<p>The problem is solved.</p>
<p>Step 2</p> <p>a Open the front door, and then firmly push it down.</p> <p>b Pull out the print cartridge tray.</p> <p>c Remove, and then insert the print cartridges.</p> <div data-bbox="215 911 943 1199" data-label="Image"> </div> <p>d Insert the print cartridge tray, and then close the door.</p> <p>e Print the document.</p> <p>Do horizontal white lines appear on prints?</p>	<p>Contact customer support.</p>	<p>The problem is solved.</p>

Vertical white lines



Note: Before solving the problem, print the Print Quality Test Pages. From the control panel, navigate to **Settings > Troubleshooting > Print Quality Test Pages**. For non-touch-screen printer models, press  to navigate through the settings.

Action	Yes	No
<p>Step 1</p> <p>a Depending on your operating system, specify the paper type from the Printing Preferences or Print dialog.</p> <p>Notes:</p> <ul style="list-style-type: none"> • Make sure that the setting matches the paper loaded. • You can also change the setting on the printer control panel. Navigate to Settings > Paper > Tray Configuration > Paper Size/Type. <p>b Print the document.</p> <p>Do vertical white lines appear on prints?</p>	<p>Go to step 2.</p>	<p>The problem is solved.</p>
<p>Step 2</p> <p>Check if you are using the recommended paper type.</p> <p>a Load the paper source with the recommended paper type.</p> <p>b Print the document.</p> <p>Do vertical white lines appear on prints?</p>	<p>Go to step 3.</p>	<p>The problem is solved.</p>
<p>Step 3</p> <p>a Open the front door, and then firmly push it down.</p> <p>b Pull out the print cartridge tray.</p> <p>c Remove, and then insert the print cartridges.</p> <div data-bbox="217 1163 946 1444" data-label="Image"> </div> <p>d Insert the print cartridge tray, and then close the door.</p> <p>e Print the document.</p> <p>Do vertical white lines appear on prints?</p>	<p>Contact customer support.</p>	<p>The problem is solved.</p>

Repeating defects



Note: Before solving the problem, print the Print Quality Test Pages. From the control panel, navigate to **Settings > Troubleshooting > Print Quality Test Pages**. For non-touch-screen printer models, press **OK** to navigate through the settings.

Action	Yes	No
<p>a Using the Print Quality Test Pages, measure the distance between the repeating defects on the affected color page.</p> <p>b Check if the repeating defects match any of the following measurements:</p> <p>Print cartridges</p> <ul style="list-style-type: none"> • 25.70 mm (1.01 in.) • 35.30 mm (1.39 in.) • 75.6 mm (2.98 in.) • 26.7 mm (1.05 in.) <p>Fuser</p> <ul style="list-style-type: none"> • 56.5 mm (2.22 in.) <p>Transfer module</p> <ul style="list-style-type: none"> • 25.10 mm (0.99 in.) • 59.70 mm (2.35 in.) • 28.30 mm (1.11 in.) • 65 mm (2.56 in.) • 44 mm (1.73 in.) <p>Do the repeating defects match any of the measurements?</p>	<p>Take note of the distance, and then contact customer support.</p>	<p>Take note of the distance, and then contact customer support.</p>

Color quality problems

Modifying the colors in printed output

For non-touch-screen printer models, press **OK** to navigate through the settings.

- 1 From the control panel, navigate to:
Settings > Print > Quality > Advanced Imaging > Color Correction
- 2 From the Color Correction menu, select **Manual > Color Correction Content**.

3 Choose the appropriate color conversion setting.

Object type	Color conversion tables
RGB Image RGB Text RGB Graphics	<ul style="list-style-type: none"> • Vivid—Produces brighter, more saturated colors and may be applied to all incoming color formats. • sRGB Display—Produces an output that approximates the colors displayed on a computer monitor. Black toner usage is optimized for printing photographs. • Display-True Black—Produces an output that approximates the colors displayed on a computer monitor. This setting uses only black toner to create all levels of neutral gray. • sRGB Vivid—Provides an increased color saturation for the sRGB Display color correction. Black toner usage is optimized for printing business graphics. • Off
CMYK Image CMYK Text CMYK Graphics	<ul style="list-style-type: none"> • US CMYK—Applies color correction to approximate the Specifications for Web Offset Publishing (SWOP) color output. • Euro CMYK—Applies color correction to approximate Euroscale color output. • Vivid CMYK—Increases the color saturation of the US CMYK color correction setting. • Off

FAQ about color printing

What is RGB color?

RGB color is a method of describing colors by indicating the amount of red, green, or blue used to produce a certain color. Red, green, and blue light can be added in various amounts to produce a large range of colors observed in nature. Computer screens, scanners, and digital cameras use this method to display colors.

What is CMYK color?

CMYK color is a method of describing colors by indicating the amount of cyan, magenta, yellow, and black used to reproduce a particular color. Cyan, magenta, yellow, and black inks or toners can be printed in various amounts to produce a large range of colors observed in nature. Printing presses, inkjet printers, and color laser printers create colors in this manner.

How is color specified in a document to be printed?

Software programs are used to specify and modify the document color using RGB or CMYK color combinations. For more information, see the software program Help topics.

How does the printer know what color to print?

When printing a document, information describing the type and color of each object is sent to the printer and is passed through color conversion tables. Color is translated into the appropriate amounts of cyan, magenta, yellow, and black toner used to produce the color you want. The object information determines the application of color conversion tables. For example, it is possible to apply one type of color conversion table to text while applying a different color conversion table to photographic images.

What is manual color correction?

When manual color correction is enabled, the printer employs user-selected color conversion tables to process objects. Manual color correction settings are specific to the type of object being printed (text, graphics, or images). It is also specific to how the color of the object is specified in the software program (RGB or CMYK combinations). To apply a different color conversion table manually, see [“Modifying the colors in printed output” on page 136](#).

If the software program does not specify colors with RGB or CMYK combinations, then manual color correction is not useful. It is also not effective if the software program or the computer operating system controls the adjustment of colors. In most situations, setting the Color Correction to Auto generates preferred colors for the documents.

How can I match a particular color (such as a corporate logo)?

From the printer Quality menu, nine types of Color Samples sets are available. These sets are also available from the Color Samples page of the Embedded Web Server. Selecting any sample set generates multiple-page prints consisting of hundreds of colored boxes. Each box contains a CMYK or RGB combination, depending on the table selected. The observed color of each box is obtained by passing the CMYK or RGB combination labeled on the box through the selected color conversion table.

By examining Color Samples sets, you can identify the box with color closest to the color being matched. The color combination labeled on the box can then be used for modifying the color of the object in a software program. For more information, see the software program Help topics. Manual color correction may be necessary to use the selected color conversion table for the particular object.

Selecting which Color Samples set to use for a particular color-matching problem depends on:

- The Color Correction setting being used (Auto, Off, or Manual)
- The type of object being printed (text, graphics, or images)
- How the color of the object is specified in the software program (RGB or CMYK combinations)

If the software program does not specify colors with RGB or CMYK combinations, then the Color Samples pages are not useful. Additionally, some software programs adjust the RGB or CMYK combinations specified in the program through color management. In these situations, the printed color may not be an exact match of the Color Samples pages.

The print appears tinted

Action	Yes	No
<p>Step 1 Perform Color Adjust.</p> <p>a From the control panel, navigate to: Settings > Print > Quality > Advanced Imaging > Color Adjust</p> <p>For non-touch-screen printer models, press  to navigate through the settings.</p> <p>b Print the document.</p> <p>Does the print appear tinted?</p>	<p>Go to step 2.</p>	<p>The problem is solved.</p>

Action	Yes	No
<p>Step 2</p> <p>a From the control panel, navigate to: Settings > Print > Quality > Advanced Imaging > Color Balance</p> <p>For non-touch-screen printer models, press  to navigate through the settings.</p> <p>b Adjust the settings.</p> <p>c Print the document.</p> <p>Does the print appear tinted?</p>	<p>Contact customer support.</p>	<p>The problem is solved.</p>

Contacting customer support

Before contacting customer support, make sure to have the following information:

- Printer problem
- Error message
- Printer model type and serial number

Go to <http://support.lexmark.com> to receive e-mail or chat support, or browse through the library of manuals, support documentation, drivers, and other downloads.

Technical support via telephone is also available. In the U.S. or Canada, call 1-800-539-6275. For other countries or regions, go to <http://support.lexmark.com>.

Recycle and dispose

Recycling Lexmark products

To return Lexmark products for recycling:

- 1 Go to www.lexmark.com/recycle.
- 2 Select the product you want to recycle.

Note: Printer supplies and hardware not listed in the Lexmark Collection and Recycling Program may be recycled through your local recycling center.

Recycling Lexmark packaging

Lexmark continually strives to minimize packaging. Less packaging helps to ensure that Lexmark printers are transported in the most efficient and environmentally sensitive manner and that there is less packaging to dispose of. These efficiencies result in fewer greenhouse emissions, energy savings, and natural resource savings. Lexmark also offers recycling of packaging components in some countries or regions. For more information, go to www.lexmark.com/recycle, and then choose your country or region. Information on available packaging recycling programs is included with the information on product recycling.

Lexmark cartons are 100% recyclable where corrugated recycling facilities exist. Facilities may not exist in your area.

The foam used in Lexmark packaging is recyclable where foam recycling facilities exist. Facilities may not exist in your area.

When you return a cartridge to Lexmark, you can reuse the box that the cartridge came in. Lexmark recycles the box.

Notices

Product information

Product name:

Lexmark C3224dw; Lexmark C3326dw; Lexmark C3426dw; Lexmark CS331dw; Lexmark CS431dw printers

Machine type:

1500

Model(s):

218, 638, 836, 8c6

Edition notice

April 2020

The following paragraph does not apply to any country where such provisions are inconsistent with local law: LEXMARK INTERNATIONAL, INC., PROVIDES THIS PUBLICATION "AS IS" WITHOUT WARRANTY OF ANY KIND, EITHER EXPRESS OR IMPLIED, INCLUDING, BUT NOT LIMITED TO, THE IMPLIED WARRANTIES OF MERCHANTABILITY OR FITNESS FOR A PARTICULAR PURPOSE. Some states do not allow disclaimer of express or implied warranties in certain transactions; therefore, this statement may not apply to you.

This publication could include technical inaccuracies or typographical errors. Changes are periodically made to the information herein; these changes will be incorporated in later editions. Improvements or changes in the products or the programs described may be made at any time.

References in this publication to products, programs, or services do not imply that the manufacturer intends to make these available in all countries in which it operates. Any reference to a product, program, or service is not intended to state or imply that only that product, program, or service may be used. Any functionally equivalent product, program, or service that does not infringe any existing intellectual property right may be used instead. Evaluation and verification of operation in conjunction with other products, programs, or services, except those expressly designated by the manufacturer, are the user's responsibility.

For Lexmark technical support, go to <http://support.lexmark.com>.

For information on Lexmark's privacy policy governing the use of this product, go to www.lexmark.com/privacy.

For information on supplies and downloads, go to www.lexmark.com.

© 2019 Lexmark International, Inc.

All rights reserved.

GOVERNMENT END USERS

The Software Program and any related documentation are "Commercial Items," as that term is defined in 48 C.F.R. 2.101, "Computer Software" and "Commercial Computer Software Documentation," as such terms are used in 48 C.F.R. 12.212 or 48 C.F.R. 227.7202, as applicable. Consistent with 48 C.F.R. 12.212 or 48 C.F.R. 227.7202-1 through 227.7207-4, as applicable, the Commercial Computer Software and Commercial Software

Documentation are licensed to the U.S. Government end users (a) only as Commercial Items and (b) with only those rights as are granted to all other end users pursuant to the terms and conditions herein.

Trademarks

Lexmark and the Lexmark logo are trademarks or registered trademarks of Lexmark International, Inc. in the United States and/or other countries.

Google Cloud Print, Google Chrome, Android, and Google Play are trademarks of Google LLC.

Macintosh, App Store, Safari, and AirPrint are trademarks of Apple Inc., registered in the U.S. and other countries. Use of the Works with Apple badge means that an accessory has been designed to work specifically with the technology identified in the badge and has been certified by the developer to meet Apple performance standards.

Mopria®, the Mopria® logo, and the Mopria® Alliance logo are registered trademarks and service marks of Mopria Alliance, Inc. in the United States and other countries. Unauthorized use is strictly prohibited.

PCL® is a registered trademark of the Hewlett-Packard Company. PCL is Hewlett-Packard Company’s designation of a set of printer commands (language) and functions included in its printer products. This printer is intended to be compatible with the PCL language. This means the printer recognizes PCL commands used in various application programs, and that the printer emulates the functions corresponding to the commands.

PostScript is a registered trademark of Adobe Systems Incorporated in the United States and/or other countries.

Wi-Fi Direct is a registered trademark of Wi-Fi Alliance®.

All other trademarks are the property of their respective owners.

Licensing notices

All licensing notices associated with this product can be viewed from the CD:\NOTICES directory of the installation software CD.

Noise emission levels

The following measurements were made in accordance with ISO 7779 and reported in conformance with ISO 9296.

Note: Some modes may not apply to your product.

1-meter average sound pressure, dBA	
Printing	One-sided: 52 (C3224dw); 53 (C3326dw, CS331dw, CS431dw, C3426dw) Two-sided: 50 (C3224dw); 52 (C3326dw, CS331dw, CS431dw, C3426dw)
Ready	14

Values are subject to change. See www.lexmark.com for current values.

Waste from Electrical and Electronic Equipment (WEEE) directive



The WEEE logo signifies specific recycling programs and procedures for electronic products in countries of the European Union. We encourage the recycling of our products.

If you have further questions about recycling options, visit the Lexmark Web site at www.lexmark.com for your local sales office phone number.

India E-Waste notice



This product complies with the India E-Waste (Management and Handling) Rules, 2011, which prohibit use of lead, mercury, hexavalent chromium, polybrominated biphenyls, or polybrominated diphenyl ethers in concentrations exceeding 0.1% by weight and 0.01% by weight for cadmium, except for the exemption set in Schedule II of the Rules.

Product disposal

Do not dispose of the printer or supplies in the same manner as normal household waste. Consult your local authorities for disposal and recycling options.

Returning Lexmark cartridges for reuse or recycling

The Lexmark Cartridge Collection Program allows you to return used cartridges for free to Lexmark for reuse or recycling. One hundred percent of the empty cartridges returned to Lexmark are either reused or demanufactured for recycling. The boxes used to return the cartridges are also recycled.

To return Lexmark cartridges for reuse or recycling, do the following:

- 1 Go to www.lexmark.com/recycle.
- 2 Select the product that you want to recycle.

Static sensitivity notice

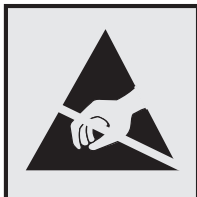

This symbol identifies static-sensitive parts. Do not touch the areas near these symbols without first touching a metal surface in an area away from the symbol.

To prevent damage from electrostatic discharge when performing maintenance tasks such as clearing paper jams or replacing supplies, touch any exposed metal frame of the printer before accessing or touching interior areas of the printer even if the symbol is not present.

ENERGY STAR

Any Lexmark product bearing the ENERGY STAR® emblem on the product or on a start-up screen is certified to comply with Environmental Protection Agency (EPA) ENERGY STAR requirements as of the date of manufacture.



Temperature information

Ambient operating temperature	10 to 32.2°C (50 to 90°F)
Shipping temperature	-40 to 43.3°C (-40 to 110°F)
Storage temperature and relative humidity	1.1 to 32.2°C (34 to 90°F) 8 to 80% RH

Laser notice

The printer is certified in the U.S. to conform to the requirements of DHHS 21 CFR, Chapter I, Subchapter J for Class I (1) laser products, and elsewhere is certified as a Class I laser product conforming to the requirements of IEC 60825-1: 2014.

Class I laser products are not considered to be hazardous. The laser system and printer are designed so there is never any human access to laser radiation above a Class I level during normal operation, user maintenance, or prescribed service conditions. The printer has a non-serviceable printhead assembly that contains a laser with the following specifications:

Class: IIIb (3b) AlGaAs

Nominal output power (milliwatts): 8

Wavelength (nanometers): 770–800

Power consumption

Product power consumption

The following table documents the power consumption characteristics of the product.

Note: Some modes may not apply to your product.

Mode	Description	Power consumption (Watts)
Printing	The product is generating hard-copy output from electronic inputs.	One-sided: 385 (C3224dw); 395 (C3326dw, CS331dw); 400 (CS431dw, C3426dw) Two-sided: 260 (C3224dw); 275 (C3326dw, CS331dw, CS431dw, C3426dw)
Copy	The product is generating hard-copy output from hard-copy original documents.	N/A
Scan	The product is scanning hard-copy documents.	N/A
Ready	The product is waiting for a print job.	15.5 (C3224dw); 17 (C3326dw, CS331dw, CS431dw, C3426dw)
Sleep Mode	The product is in a high-level energy-saving mode.	0.86 (C3224dw); 0.84 (C3326dw, CS331dw); 1.19 (CS431dw, C3426dw)
Hibernate	The product is in a low-level energy-saving mode.	N/A
Off	The product is plugged into an electrical outlet, but the power switch is turned off.	0.1

The power consumption levels listed in the previous table represent time-averaged measurements. Instantaneous power draws may be substantially higher than the average.

Values are subject to change. See www.lexmark.com for current values.

Sleep Mode

This product is designed with an energy-saving mode called *Sleep Mode*. The Sleep Mode saves energy by lowering power consumption during extended periods of inactivity. The Sleep Mode is automatically engaged after this product is not used for a specified period of time, called the *Sleep Mode Timeout*.

Factory default Sleep Mode Timeout for this product (in minutes):	15
---	----

By using the configuration menus, the Sleep Mode Timeout can be modified between 1 minute and 120 minutes. If the print speed is less than or equal to 30 pages per minute, then you can set the timeout only up to 60 minutes. Setting the Sleep Mode Timeout to a low value reduces energy consumption, but may increase the response time of the product. Setting the Sleep Mode Timeout to a high value maintains a fast response, but uses more energy.

Hibernate Mode

This product is designed with an ultra-low power operating mode called *Hibernate mode*. When operating in Hibernate Mode, all other systems and devices are powered down safely.

The Hibernate mode can be entered in any of the following methods:

- Using the Hibernate Timeout
- Using the Schedule Power modes

Factory default Hibernate Timeout for this product in all countries or regions	3 days
--	--------

The amount of time the printer waits after a job is printed before it enters Hibernate mode can be modified between one hour and one month.

Off mode

If this product has an off mode which still consumes a small amount of power, then to completely stop product power consumption, disconnect the power supply cord from the electrical outlet.

Total energy usage

It is sometimes helpful to estimate the total product energy usage. Since power consumption claims are provided in power units of Watts, the power consumption should be multiplied by the time the product spends in each mode in order to calculate energy usage. The total product energy usage is the sum of each mode's energy usage.

Regulatory notices for wireless products

This section contains regulatory information that applies only to wireless models.

If in doubt as to whether your model is a wireless model, go to <http://support.lexmark.com>.

Modular component notice

Wireless models contain one of the following modular components:

Lexmark Regulatory Type/Model Number LEX-M08-001; FCC ID:IYLLEXM08001; IC:2376A-LEXM08001

Lexmark Regulatory Type/Model Number LEX-M07-001; FCC ID:IYLLEXM07001; IC:2376A-LEXM07001

To determine which modular components are installed in your particular product, refer to the labeling on your actual product.

Exposure to radio frequency radiation

The radiated output power of this device is far below the radio frequency exposure limits of the FCC and other regulatory agencies. A minimum separation of 20 cm (8 inches) must be maintained between the antenna and any persons for this device to satisfy the RF exposure requirements of the FCC and other regulatory agencies.

Industry Canada (Canada)

This device complies with Industry Canada license-exempt RSS standards. Operation is subject to the following two conditions: (1) this device may not cause interference, and (2) this device must accept any interference, including interference that may cause undesired operation of the device.

Industrie Canada (Canada)

Cet appareil est conforme aux normes RSS exemptes de licence d'Industrie Canada. Son fonctionnement est soumis aux deux conditions suivantes : (1) cet appareil ne doit pas causer d'interférences et (2) il doit accepter toutes les interférences, y compris les celles qui peuvent entraîner un fonctionnement indésirable.

Singapore IMDA statement

This product is approved for use in Singapore.



European Community (EC) directives conformity

This product is in conformity with the protection requirements of EC Council directive 2014/53/EU on the approximation and harmonization of the laws of the Member States relating to radio equipment.

The manufacturer of this product is: Lexmark International, Inc., 740 West New Circle Road, Lexington, KY, 40550 USA. The authorized representative is: Lexmark International Technology Hungária Kft., 8 Lechner Ödön fasor, Millennium Tower III, 1095 Budapest HUNGARY. A declaration of conformity to the requirements of the Directives is available upon request from the Authorized Representative or may be obtained at www.lexmark.com/en_us/about/regulatory-compliance/european-union-declaration-of-conformity.html.

Compliance is indicated by the CE marking:



Restrictions

This radio equipment is restricted to indoor use only. Outdoor use is prohibited. This restriction applies to all the countries listed in the table below:



AT	BE	BG	CH	CY	CZ	DE	DK	EE
EL	ES	FI	FR	HR	HU	IE	IS	IT
LI	LT	LU	LV	MT	NL	NO	PL	PT
RO	SE	SI	SK	TR	UK			

EU and other countries statement of radio transmitter operational frequency bands and maximum RF power

This radio product transmits in either the 2.4GHz (2.412–2.472 GHz in the EU) or 5GHz (5.15–5.35, 5.47–5.725 in the EU) bands. The maximum transmitter EIRP power output, including antenna gain, is ≤ 20dBm for both bands.

Federal Communications Commission (FCC) compliance information statement

This product has been tested and found to comply with the limits for a Class B digital device, pursuant to Part 15 of the FCC Rules. Operation is subject to the following two conditions: (1) this device may not cause harmful interference, and (2) this device must accept any interference received, including interference that may cause undesired operation.

The FCC Class B limits are designed to provide reasonable protection against harmful interference when the equipment is operated in a residential installation. This equipment generates, uses, and can radiate radio frequency energy and, if not installed and used in accordance with the instructions, may cause harmful interference to radio communications. However, there is no guarantee that interference will not occur in a particular installation. If this equipment does cause harmful interference to radio or television reception, which can be determined by turning the equipment off and on, the user is encouraged to try to correct the interference by one or more of the following measures:

- Reorient or relocate the receiving antenna.
- Increase the separation between the equipment and receiver.
- Connect the equipment into an outlet on a circuit different from that to which the receiver is connected.
- Consult your point of purchase or service representative for additional suggestions.

The manufacturer is not responsible for radio or television interference caused by using other than recommended cables or by unauthorized changes or modifications to this equipment. Unauthorized changes or modifications could void the user's authority to operate this equipment.

Note: To assure compliance with FCC regulations on electromagnetic interference for a Class B computing device, use a properly shielded and grounded cable such as Lexmark part number 1021231 for parallel attach or 1021294 for USB attach. Use of a substitute cable not properly shielded and grounded may result in a violation of FCC regulations.

Any questions regarding this compliance information statement should be directed to:

Director of Lexmark Technology & Services
Lexmark International, Inc.
740 West New Circle Road
Lexington, KY 40550
Telephone: (859) 232-2000
E-mail: regulatory@lexmark.com

Industry Canada compliance statement

This Class B digital apparatus meets all requirements of the Canadian Interference-Causing Equipment Standard ICES-003.

Avis de conformité aux normes de l'industrie du Canada

Cet appareil numérique de classe B est conforme aux exigences de la norme canadienne relative aux équipements pouvant causer des interférences NMB-003.

日本の VCCI 規定

製品にこのマークが表示されている場合、次の要件を満たしています。



この装置は、クラス B 情報技術装置です。この装置は、家庭環境で使用することを目的としていますが、この装置がラジオやテレビジョン受信機に近接して使用されると、受信障害を引き起こすことがあります。取扱説明書に従って正しい取り扱いをしてください。

VCCI-B

European Community (EC) directives conformity

This product is in conformity with the protection requirements of EC Council directive 2014/53/EU on the approximation and harmonization of the laws of the Member States relating to radio equipment.

The manufacturer of this product is: Lexmark International, Inc., 740 West New Circle Road, Lexington, KY, 40550 USA. The authorized representative is: Lexmark International Technology Hungária Kft., 8 Lechner Ödön fasor, Millennium Tower III, 1095 Budapest HUNGARY. A declaration of conformity to the requirements of the Directives is available upon request from the Authorized Representative or may be obtained at www.lexmark.com/en_us/about/regulatory-compliance/european-union-declaration-of-conformity.html.

Compliance is indicated by the CE marking:



Restrictions

This radio equipment is restricted to indoor use only. Outdoor use is prohibited. This restriction applies to all the countries listed in the table below:

								
AT	BE	BG	CH	CY	CZ	DE	DK	EE
EL	ES	FI	FR	HR	HU	IE	IS	IT
LI	LT	LU	LV	MT	NL	NO	PL	PT
RO	SE	SI	SK	TR	UK			

EU statement of radio transmitter operational frequency bands and maximum RF power

This radio product transmits in either the 2.4GHz (2.412–2.472 GHz in the EU) or 5GHz (5.15–5.35, 5.47–5.725 in the EU) bands. The maximum transmitter EIRP power output, including antenna gain, is ≤ 20dBm for both bands.

STATEMENT OF LIMITED WARRANTY FOR LEXMARK LASER PRINTERS, LEXMARK LED PRINTERS, AND LEXMARK MULTIFUNCTION LASER PRINTERS

Lexmark International, Inc., Lexington, KY

This limited warranty applies to the United States and Canada. For customers outside the U.S., refer to the country-specific warranty information that came with your product.

This limited warranty applies to this product only if it was originally purchased for your use, and not for resale, from Lexmark or a Lexmark Remarketer, referred to in this statement as “Remarketer.”

Limited warranty

Lexmark warrants that this product:

- Is manufactured from new parts, or new and serviceable used parts, which perform like new parts
- Is, during normal use, free from defects in material and workmanship

If this product does not function as warranted during the warranty period, contact a Remarketer or Lexmark for repair or replacement (at Lexmark's option).

If this product is a feature or option, this statement applies only when that feature or option is used with the product for which it was intended. To obtain warranty service, you may be required to present the feature or option with the product.

If you transfer this product to another user, warranty service under the terms of this statement is available to that user for the remainder of the warranty period. You should transfer proof of original purchase and this statement to that user.

Limited warranty service

The warranty period starts on the date of original purchase as shown on the purchase receipt and ends 12 months later provided that the warranty period for any supplies and for any maintenance items included with the printer shall end earlier if it, or its original contents, are substantially used up, depleted, or consumed. Fuser Units, Transfer/Transport Units, Paper Feed items, if any, and any other items for which a Maintenance Kit is available are substantially consumed when the printer displays a “Life Warning” or “Scheduled Maintenance” message for such item.

To obtain warranty service you may be required to present proof of original purchase. You may be required to deliver your product to the Remarketer or Lexmark, or ship it prepaid and suitably packaged to a Lexmark designated location. You are responsible for loss of, or damage to, a product in transit to the Remarketer or the Lexmark designated location.

When warranty service involves the exchange of a product or part, the item replaced becomes the property of the Remarketer or Lexmark. The replacement may be a new or repaired item.

The replacement item assumes the remaining warranty period of the original product.

Replacement is not available to you if the product you present for exchange is defaced, altered, in need of a repair not included in warranty service, damaged beyond repair, or if the product is not free of all legal obligations, restrictions, liens, and encumbrances.

As part of your warranty service and/or replacement, Lexmark may update the firmware in your printer to the latest version. Firmware updates may modify printer settings and cause counterfeit and/or unauthorized products, supplies, parts, materials (such as toners and inks), software, or interfaces to stop working. Authorized use of genuine Lexmark products will not be impacted.

Before you present this product for warranty service, remove all print cartridges, programs, data, and removable storage media (unless directed otherwise by Lexmark).

For further explanation of your warranty alternatives and the nearest Lexmark authorized servicer in your area contact Lexmark on the World Wide Web.

Remote technical support is provided for this product throughout its warranty period. For products no longer covered by a Lexmark warranty, technical support may not be available or only be available for a fee.

Extent of limited warranty

Lexmark does not warrant uninterrupted or error-free operation of any product or the durability or longevity of prints produced by any product.

Warranty service does not include repair of failures caused by:

- Modification or unauthorized attachments
- Accidents, misuse, abuse or use inconsistent with Lexmark user’s guides, manuals, instructions or guidance
- Unsuitable physical or operating environment
- Maintenance by anyone other than Lexmark or a Lexmark authorized servicer
- Operation of a product beyond the limit of its duty cycle
- Use of printing media outside of Lexmark specifications

- Refurbishment, repair, refilling or remanufacture by a third party of products, supplies or parts
- Products, supplies, parts, materials (such as toners and inks), software, or interfaces not furnished by Lexmark

TO THE EXTENT PERMITTED BY APPLICABLE LAW, NEITHER LEXMARK NOR ITS THIRD PARTY SUPPLIERS OR REMARKETERS MAKE ANY OTHER WARRANTY OR CONDITION OF ANY KIND, WHETHER EXPRESS OR IMPLIED, WITH RESPECT TO THIS PRODUCT, AND SPECIFICALLY DISCLAIM THE IMPLIED WARRANTIES OR CONDITIONS OF MERCHANTABILITY, FITNESS FOR A PARTICULAR PURPOSE, AND SATISFACTORY QUALITY. ANY WARRANTIES THAT MAY NOT BE DISCLAIMED UNDER APPLICABLE LAW ARE LIMITED IN DURATION TO THE WARRANTY PERIOD. NO WARRANTIES, EXPRESS OR IMPLIED, WILL APPLY AFTER THIS PERIOD. ALL INFORMATION, SPECIFICATIONS, PRICES, AND SERVICES ARE SUBJECT TO CHANGE AT ANY TIME WITHOUT NOTICE.

Limitation of liability

Your sole remedy under this limited warranty is set forth in this document. For any claim concerning performance or nonperformance of Lexmark or a Remarketer for this product under this limited warranty, you may recover actual damages up to the limit set forth in the following paragraph.

Lexmark's liability for actual damages from any cause whatsoever will be limited to the amount you paid for the product that caused the damages. This limitation of liability will not apply to claims by you for bodily injury or damage to real property or tangible personal property for which Lexmark is legally liable. **IN NO EVENT WILL LEXMARK BE LIABLE FOR ANY LOST PROFITS, LOST SAVINGS, INCIDENTAL DAMAGE, OR OTHER ECONOMIC OR CONSEQUENTIAL DAMAGES.** This is true even if you advise Lexmark or a Remarketer of the possibility of such damages. Lexmark is not liable for any claim by you based on a third party claim.

This limitation of remedies also applies to claims against any Suppliers and Remarketers of Lexmark. Lexmark's and its Suppliers' and Remarketers' limitations of remedies are not cumulative. Such Suppliers and Remarketers are intended beneficiaries of this limitation.

Additional rights

Some states do not allow limitations on how long an implied warranty lasts, or do not allow the exclusion or limitation of incidental or consequential damages, so the limitations or exclusions contained above may not apply to you.

This limited warranty gives you specific legal rights. You may also have other rights that vary from state to state.

Index

A

- adding hardware options
 - print driver 27
- adding internal options
 - print driver 27
- adjusting brightness
 - printer display 88
- adjusting toner darkness 37
- AirPrint
 - using 34
- Android device
 - printing from 33
- attaching cables 19
- avoiding paper jams 93

B

- black images 126
- blank or white pages 113
- bookmarks
 - creating 21
 - creating folders for 21

C

- canceling a print job
 - from the computer 37
 - from the printer control panel 37
- cannot open Embedded Web Server 91
- checking the printer connectivity 30
- checking the status of parts and supplies 74
- cleaning the printer 87
- clearances around the printer 18
- clearing jam
 - in door B 101
 - in the duplex unit 101
 - in the fuser area 101
 - in the manual feeder 100
 - in the optional tray 97
 - in the standard tray 95
- Cloud Connector profile
 - creating 20
 - printing from 36
- collated printing does not work 104

- Color Correction
 - manual 136
- Color Correction Content 136
- colored background on prints 117
- confidential documents do not print 108
- confidential print jobs
 - configuring 35
 - printing from a Macintosh computer 35
 - printing from Windows 35
- configuring supply notifications 74
- configuring the SMTP server 31
- configuring Universal paper 22
- connecting the printer
 - to a wireless network 28
- connecting to a wireless network
 - using PIN method 29
 - using Push Button method 29
- conserving supplies 88
- contacting customer support 139
- control panel
 - using 11
- creating a Cloud Connector profile 20
- creating bookmarks 21
- creating folders
 - for bookmarks 21
- customer support
 - contacting 139

D

- deactivating the Wi-Fi network 30
- display brightness
 - adjusting 88
- documents, printing
 - from a computer 33
 - from a mobile device 33
- dots on print 122

E

- emission notices 142, 146, 149
- envelope seals when printing 104
- envelopes
 - loading 24

- environmental setting
 - Hibernate mode 87
 - sleep mode 87
- erasing printer memory 32
- Ethernet port 19
- exporting a configuration file
 - using the Embedded Web Server 27
- e-mail alerts
 - setting up 74
- e-mail server
 - setting up 31

F

- factory default settings
 - restoring 32
- FAQ about color printing 137
- FCC notices 146
- finding more information about the printer 8
- firmware, updating 26
- font sample list
 - printing 36

G

- genuine Lexmark parts and supplies 75
- genuine parts and supplies 75
- ghost images on prints 116
- Google Cloud Print
 - using 33
- gray background on prints 117

H

- hardware options
 - trays 19
- hardware options, adding
 - print driver 27
- held documents do not print 108
- held jobs 35
 - printing from a Macintosh computer 35
 - printing from Windows 35
- Hibernate mode
 - configuring 87
- home screen
 - customizing 12

home screen icons
 displaying 12
horizontal dark lines 130
horizontal white lines 133

I

icons on the home screen
 showing 12
identifying jam locations 95
images cut off on print 127
importing a configuration file
 using the Embedded Web
 Server 27
incorrect margins 118
indicator light
 understanding the status 12
installing the print driver 26
installing the printer software 26
installing trays 19
internal options, adding
 print driver 27

J

jammed pages are not
 reprinted 107
jams
 avoiding 93
jams, clearing
 in the standard bin 99

L

letterhead
 loading 24
 selecting 14
Lexmark Mobile Print
 using 33
light print 119
linking trays 26
loading trays 22
locating jam areas 95

M

manual color correction
 applying 136
manual feeder
 loading 24
 replacing 82
memory
 types installed on printer 32
menu
 802.1x 65

About this Printer 47
Certificate Management 70
Cloud Connector 72
Confidential Print Setup 70
Config Menu 44
Device 72
Eco-Mode 40
Erase Temporary Data Files 71
Ethernet 59
Google Cloud Print 68
HTTP/FTP Settings 65
Image 53
Information Sent to Lexmark 43
IPSec 63
Layout 48
Local Accounts 69
Login Restrictions 70
LPD Configuration 65
Media Types 55
Menu Settings Page 72
Miscellaneous 72
Network 73
Network Overview 56
Notifications 41
Out of Service Erase 47
PCL 52
PostScript 51
Power Management 42
Preferences 38
Print 73
Public 68
Quality 50
Remote Operator Panel 40
Restore Factory Defaults 43
Restrict external network
 access 67
 Setup 49
SNMP 62
TCP/IP 61
Tray Configuration 54
Troubleshooting 73
Universal Setup 55
USB 66
Visible Home Screen Icons 47
Wireless 57
Wi-Fi Direct 67
Menu Settings Page
 printing 31
missing colors 121
mobile device
 printing from 33, 34
Mopria Print Service 33

mottled print 122
moving the printer 88

N

noise emission levels 142
Non-Lexmark supply 92
non-volatile memory 32
 erasing 32
notices 142, 143, 144, 145, 146,
149

O

ordering supplies
 print cartridge 75
 waste toner bottle 78

P

paper
 letterhead 14
 preprinted forms 14
 selecting 13
 unacceptable 14
paper characteristics 13
paper curl 124
paper guidelines 13
paper jam
 in the optional tray 97
 in the standard tray 95
paper jam in door B 101
paper jam in the manual
 feeder 100
paper jams
 avoiding 93
 location 95
paper jams, clearing
 in the standard bin 99
paper sizes
 supported 15
paper types
 supported 16
paper weights
 supported 17
personal identification number
 method 29
pick tires
 replacing 82
placing separator sheets 37
power cord socket 19
preprinted forms
 selecting 14

- print cartridge
 - ordering 75
 - replacing 78
 - print driver
 - hardware options, adding 27
 - installing 26
 - print job
 - canceling from the computer 37
 - canceling from the printer control panel 37
 - print jobs
 - storing 35
 - print jobs not printed 107
 - Print Quality Test Pages 73
 - print quality troubleshooting
 - blank pages 113
 - crooked print 126
 - dark print 114
 - ghost images on prints 116
 - gray or colored background 117
 - horizontal dark lines 130
 - horizontal white lines 133
 - light print 119
 - missing colors 121
 - mottled print and dots 122
 - paper curl 124
 - print appears tinted 138
 - repeating defects 136
 - skewed print 126
 - solid color or black images 126
 - text or images cut off 127
 - toner easily rubs off 128
 - uneven print density 129
 - vertical dark lines 132
 - vertical white lines 134
 - white pages 113
 - print troubleshooting
 - collated printing does not work 104
 - confidential and other held documents do not print 108
 - envelope seals when printing 104
 - incorrect margins 118
 - jammed pages are not reprinted 107
 - job prints from the wrong tray 109
 - job prints on the wrong paper 109
 - paper frequently jams 106
 - print jobs do not print 107
 - slow printing 110
 - tray linking does not work 105
 - printer
 - shipping 89
 - printer configuration 10
 - printer connectivity
 - checking 30
 - printer information
 - finding 8
 - printer is not responding 90
 - printer location
 - selecting 18
 - printer memory
 - erasing 32
 - printer menus 38
 - printer messages
 - Non-Lexmark supply 92
 - Replace cartridge, printer region mismatch 92
 - printer parts
 - cleaning 87
 - printer ports 19
 - printer reports
 - viewing 75
 - printer settings
 - restoring factory default 32
 - printer software
 - installing 26
 - printer status 12
 - printing
 - font sample list 36
 - from a Cloud Connector profile 36
 - from a computer 33
 - from a mobile device 33, 34
 - from an Android device 33
 - Menu Settings Page 31
 - using Google Cloud Print 33
 - using Mopria Print Service 33
 - using Wi-Fi Direct 34
 - printing confidential and other held jobs
 - from a Macintosh computer 35
 - from Windows 35
 - printing from a computer 33
 - Push Button method 29
- R**
 - recycling
 - Lexmark packaging 140
 - Lexmark products 140
- removing paper jam
 - in the duplex unit 101
 - in the fuser area 101
 - in the manual feeder 100
 - in the optional tray 97
 - in the standard tray 95
- repeat print jobs 35
 - printing from a Macintosh computer 35
 - printing from Windows 35
- repeating defects on print 136
- Replace cartridge, printer region mismatch 92
- replacing parts
 - manual feeder 82
 - pick tires 82
 - tray 81
- replacing supplies
 - print cartridge 78
 - waste toner bottle 80
- reserve print jobs
 - printing from a Macintosh computer 35
 - printing from Windows 35
- resetting
 - supply usage counters 92
- resetting the supply usage counters 86
- restoring factory default settings 32
- S**
- safety information 5, 6, 7
 - selecting a location for the printer 18
 - separator sheets
 - placing 37
 - setting the paper size 22
 - setting the paper type 22
 - setting up e-mail 31
 - setting up e-mail alerts 74
 - shipping the printer 89
 - sleep mode
 - configuring 87
 - slow printing 110
 - SMTP server
 - configuring 31
 - solid color 126
 - statement of volatility 32
 - status of parts
 - checking 74

- status of supplies
 - checking 74
- storing paper 14
- supplies
 - conserving 88
- supply notifications
 - configuring 74
- supply usage counters
 - resetting 86, 92
- supported paper sizes 15
- supported paper types 16
- supported paper weights 17

T

- temperature around the printer 18
- text cut off on print 127
- toner darkness
 - adjusting 37
- trays
 - installing 19
 - linking 26
 - loading 22
 - replacing 81
 - unlinking 26
- troubleshooting
 - cannot open Embedded Web Server 91
 - FAQ about color printing 137
 - printer is not responding 90
- troubleshooting, print
 - collated printing does not work 104
 - confidential and other held documents do not print 108
 - envelope seals when printing 104
 - incorrect margins 118
 - jammed pages are not reprinted 107
 - job prints from the wrong tray 109
 - job prints on the wrong paper 109
 - paper frequently jams 106
 - print jobs do not print 107
 - slow printing 110
 - tray linking does not work 105
- troubleshooting, print quality
 - blank pages 113
 - crooked print 126
 - dark print 114

- ghost images on prints 116
- gray or colored background 117
- horizontal dark lines 130
- horizontal white lines 133
- light print 119
- missing colors 121
- mottled print and dots 122
- paper curl 124
- print appears tinted 138
- repeating defects 136
- skewed print 126
- solid color or black images 126
- text or images cut off 127
- toner easily rubs off 128
- uneven print density 129
- vertical dark lines 132
- vertical white lines 134
- white pages 113

U

- uneven print density 129
- Universal paper
 - configuring 22
- unlinking trays 26
- updating firmware 26
- USB printer port 19
- using genuine Lexmark parts and supplies 75
- using the control panel 11

V

- verify print jobs 35
 - printing from a Macintosh computer 35
 - printing from Windows 35
- vertical dark lines 132
- vertical white lines 134
- viewing reports 75
- volatile memory 32
 - erasing 32
- volatility
 - statement of 32

W

- waste toner bottle
 - ordering 78
 - replacing 80
- wireless network
 - connecting the printer to 28
 - Wi-Fi Protected Setup 29
- wireless networking 28

- Wi-Fi Direct
 - printing from a mobile device 34
- Wi-Fi network
 - deactivating 30
- Wi-Fi Protected Setup
 - wireless network 29