

PHILIPS

hue personal wireless lighting

Festavia string lights 500 LEDs

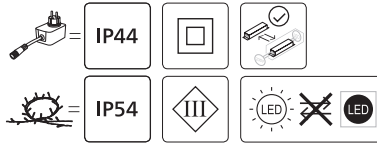
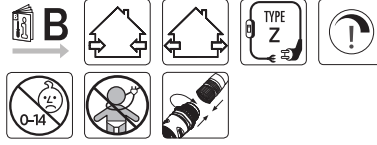
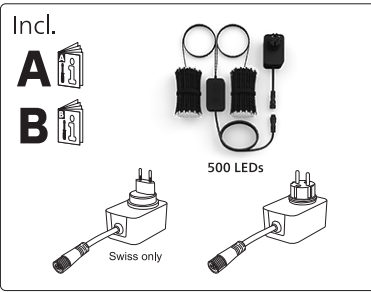

2

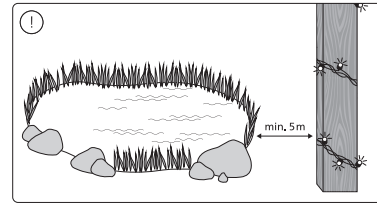
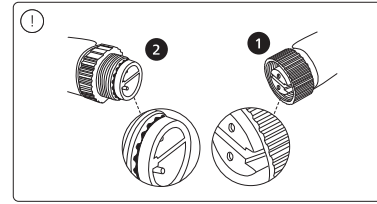
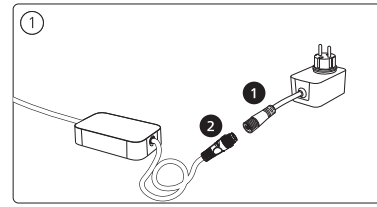

3



Signify  
I.B.R.S. / C.C.R.I. Numéro 10461  
5600 VB Eindhoven,  
the Netherlands  
00800-74454775

© 2023 Signify Holding  
All rights reserved

www.philips-hue.com

442296206321  
Last update: 05/2023



User manual  
Benutzerhandbuch  
Notice d'emploi  
Manual de usuario  
Manual do usuário  
Manuale d'uso

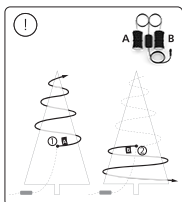
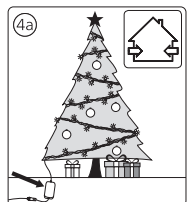
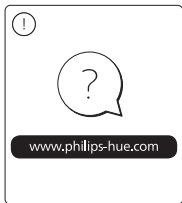
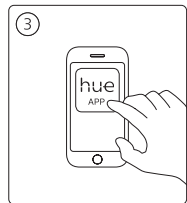
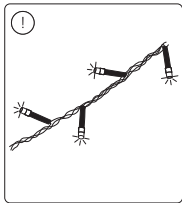
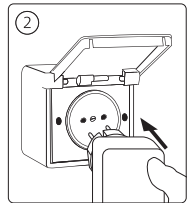

4

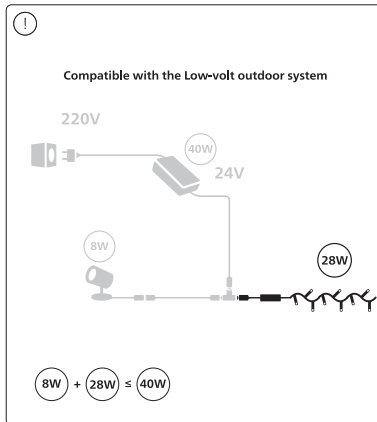
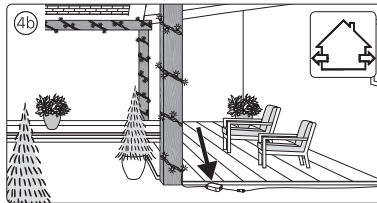

5

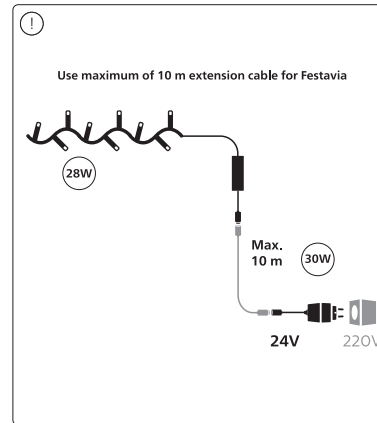

6

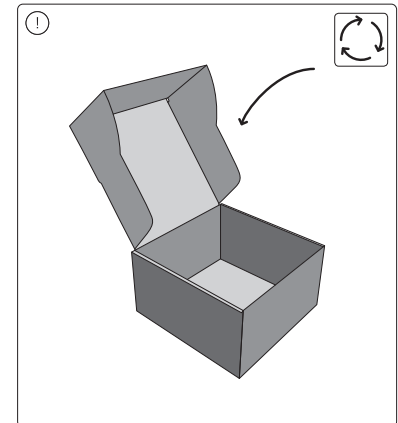
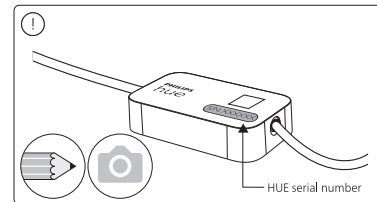

7