

User Manual

FHD PoE IP Camera



Model: FI9961EP D2EP

Table of Contents

Security Warning	1
1 Overview	2
1.1 Key Features.....	2
1.2 PoE (Power over Ethernet).....	2
1.3 Read before Use.....	3
1.4 Packing Contents.....	3
1.5 Physical Description.....	3
1.6 SD Card Management	4
1.7 Wall Installation	5
2 Access the IP Camera.....	6
2.1 Hardware Connection & Software Installation	6
2.2 Access the Camera In LAN.....	6
2.3 Access the Camera in WAN.....	8
2.4 Using the VLC Player	8
2.5 IP Camera Connection to the Server.....	11
3 Surveillance Software GUI	12
3.1 Login Window	12
3.2 Surveillance Window.....	14
4 Advanced Camera Settings.....	19
4.1 Setup Wizard	19
4.2 Device Status	19
4.3 Basic Settings	21
4.4 Network	26
4.5 Video	31
4.6 Motion Detection	34
4.7 Record.....	37
4.8 Firewall.....	40
4.9 System	40
5 Playback.....	44
6 Appendix.....	46
6.1 Frequently Asked Questions.....	46
6.2 Default Parameters	55
6.3 Specification.....	56
6.4 CE & FCC	57
6.5 WARRANTY.....	58
6.6 Statement	60
7 Obtaining Technical Support	62

Security Warning

- Please change the password of your camera regularly, using a combination of numbers, letters and special characters.
- We recommend that you regularly update your camera to the latest available software and firmware versions to help ensure the best experience for your camera.

1 Overview

Foscam Outdoor FHD IP Camera is an integrated IP Camera with a color CMOS sensor enabling viewing in High Definition resolution. It combines a high quality digital video camera, with a powerful web server, to bring clear video to your desktop from anywhere on your local network or over the Internet.

The IP Camera supports the industry-standard H.264 compression technology, drastically reducing file sizes and conserving valuable network bandwidth.

The IP Camera is based on the TCP / IP standard. There is a WEB server inside which could support Internet Explorer. Therefore the management and maintenance of your device is simplified by using the network to achieve the remote configuration and start-up.

The camera is designed for outdoor surveillance applications such as courtyards, supermarket, and school. Controlling the IP camera and managing images are simplified by using the provided web interface across the network utilizing connectivity.

1.1 Key Features

- ◆ Standard H.264 video compression algorithm to satisfy the transmission of high definition video in narrow bandwidth network
- ◆ 2.0 Mega-Pixel
- ◆ Supports IE / Firefox / Google / Safari browser or any other standard browsers
- ◆ Supports WPA and WPA2 Encryption
- ◆ PoE compliant with PoE standards IEEE 802.3af
- ◆ 1 infrared array LED for IR range up to 20m (66ft)
- ◆ Supports image snapshot
- ◆ Supports dual-stream
- ◆ Supports IR-Cut and the filter change automatically
- ◆ Supports remote viewing & record from anywhere anytime
- ◆ Multi-level users management with password protection
- ◆ Motion detection alert via email or upload image to FTP
- ◆ Supports multiple network protocols: HTTP / HTTPS / RTSP / TCP / IP / UDP / FTP / DHCP / ONVIF
- ◆ Providing Video Management Software to manage or monitor multi-cameras
- ◆ Supports Wide Dynamic Range

1.2 PoE (Power over Ethernet)

The Network Camera is PoE-compliant, allowing transmission of power and data via a single Ethernet cable. Such as the following picture: connect the Network Camera to a PoE-enabled router / switch via Ethernet cable.

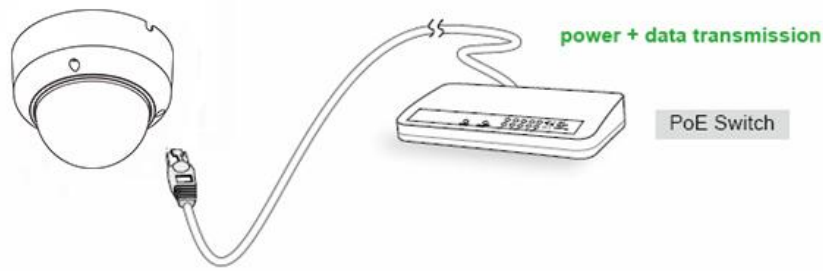

1.3 Read before Use

Please first verify that all contents received are complete according to the Package Contents listed below. Before the Network Camera is installed, please carefully read and follow the instructions in the Quick Setup Guide to avoid damage due to faulty assembly and installation. This also ensures the product is used properly as intended.

1.4 Packing Contents

• IP Camera × 1	• Power Adapter × 1
• Quick Setup Guide × 1	• Ethernet Cable × 1

1.5 Physical Description

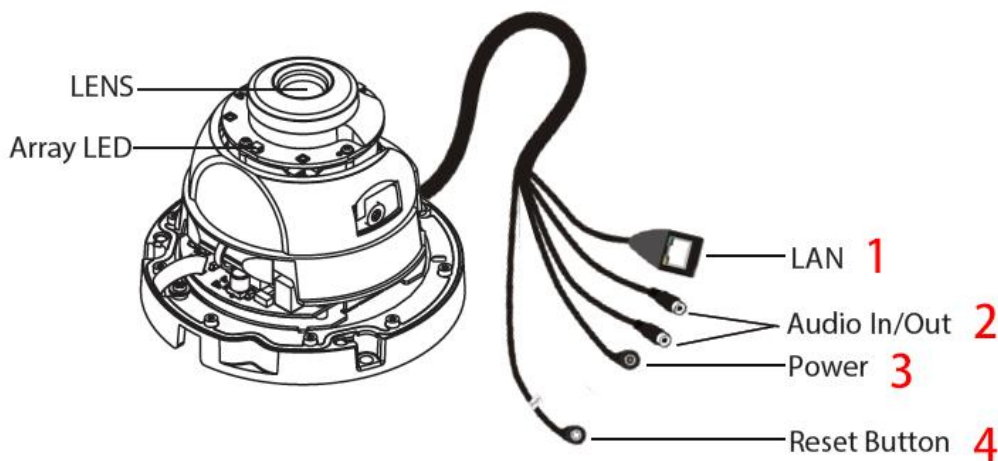

1 LAN

10/100M adaptive Ethernet interface. Through this interface, IP camera can be connected with various network devices, such as hub, router, etc.

2 Audio Input / Output

- Audio input interface

The jack is used to plug external input device such as sound pick up device directly. Here microphone cannot directly insert to the interface, it must connect to adapter first.

- Audio output interface

The jack is used to plug external output device such as loud speaker directly. Here microphone cannot directly insert to the interface, it must connect to adapter first.

3 Power Interface

Connect the external power adapter, request for 12V / 1A power.

4 Reset Button

Press and hold on the reset button for 5 seconds. Releasing the reset button, the password will back to the factory default administrator password. The default administrator user is admin with no password.

NOTE: There are up to two labels located at the bottom of the camera, this is an important feature of original Foscam cameras. If your camera does not have labels, it may be a clone. Cloned Foscam cameras can not use original firmware and are not eligible for warranty or technical services.

1.6 SD Card Management

The record files of the IPC can be stored in the Micro SD Card.

You need open the IP Camera, then plug Micro the SD card into SD card slot inside the IP Camera.

When you plug in the Micro SD card during the camera work process, please reboot the camera again, or else the Micro SD Card may be cannot work well.

Insert Micro SD Card in the location shown below.

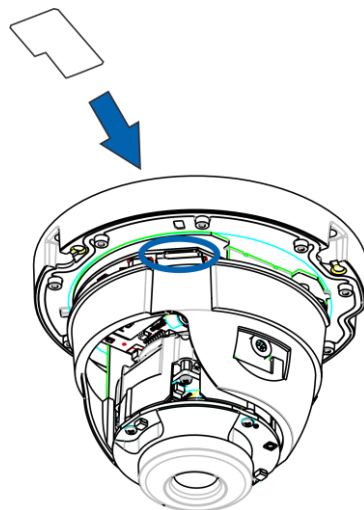

NOTE: When you re-install the camera, please ensure the tightness with the camera.

1.7 Wall Installation

Please refer to the **Quick Setup Guide**.

NOTE: Ensure that the rain or water will not reach the connector ports at the end of the pig tail wiring. These connectors are not weather-resistant.

The cable of an outdoor camera should, from the position where the cable is divided into several cables, be fitted dry. Install the cable into a waterproof junction box (1) or bring the cable indoors (2).

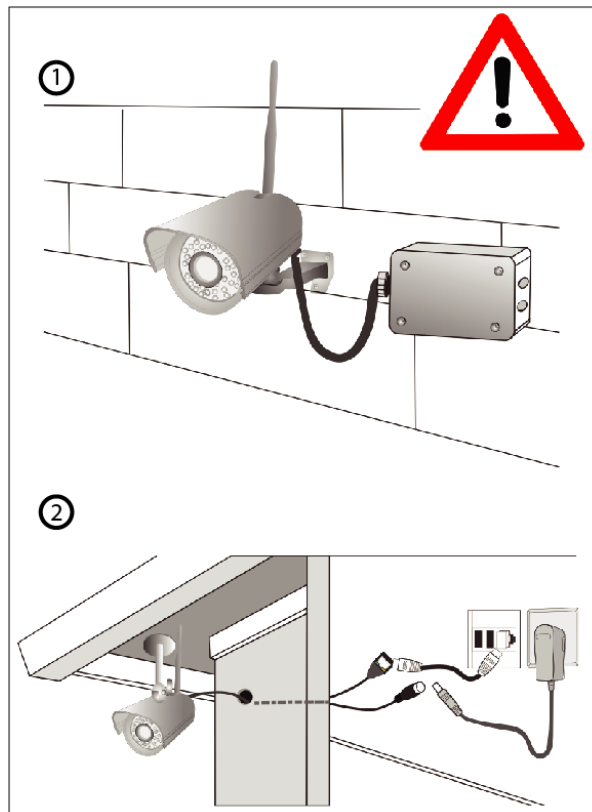

2 Access the IP Camera

2.1 Hardware Connection & Software Installation

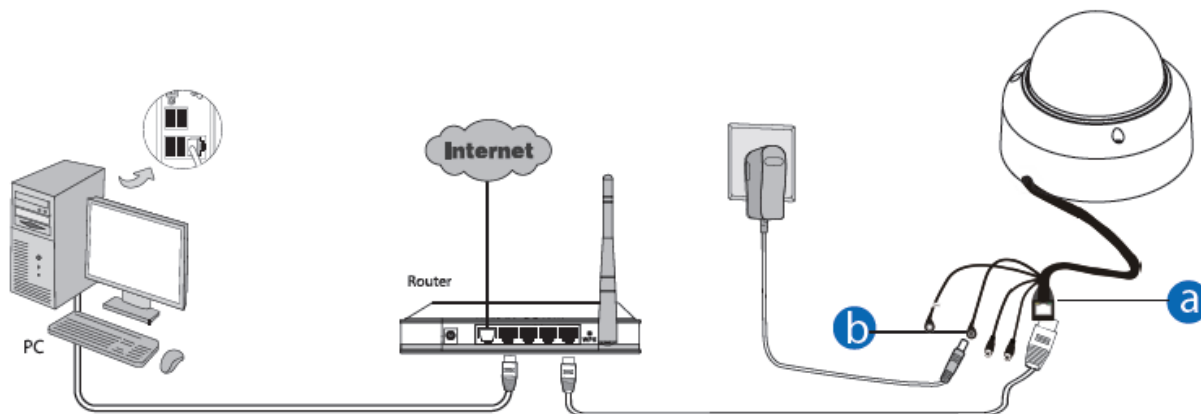

- a. Connect the camera to the LAN network (Router or Switch) via network cable.
- b. If the Router or Switch supports PoE function, power adapter is unnecessary. If not, please connect the power adapter to the camera.
- c. Visit Foscam official website <http://www.foscam.com>, select “Support > Download Center > Software Tools”, then you can find the “Equipment Search Tool”, download the tool to your computer, the icon shows as below:



NOTES:

- If your computer (Windows OS) supports autorun function, you can find the corresponding file in the opened control panel.

2.2 Access the Camera In LAN

The camera supports HTTP and HTTPS protocols, you can access the camera in two ways.

(1) Http:// LAN IP + Http Port No.

The default HTTP port NO. is 88. Double click the Search Tool icon to run, and it should find the camera's IP address automatically after you plug in the network cable.

Camera Name	IP Address	Device ID	Type
FI9961EP	Http://192.168.1.103:88	AOED6F69FFA8	IPC

Double click the IP address of the camera; the camera login page should be open in your default browser.

(2) Https:// LAN IP + Https Port no.

The default HTTPS port NO. is 443. You can use the URL to access the camera: https:// LAN IP + HTTPS port NO.

Go to **Settings > Network > Port** panel, you can see and change the HTTP and HTTPS port NO.

Port

Save
Refresh

HTTP Port	<input type="text" value="88"/>
HTTPS Port	<input type="text" value="443"/>

NOTE: When logging in for the first time, you will need to download and install the add-on.

FOSCAM
HD IP Camera

You have not installed the plugin, please enter the account and password to download

Username

Password

Language

Download

Click Run

Do you want to run or save 5.1.0.13--1547793391598.exe (2.86 MB) from download.myfoscam.com?

This type of file could harm your computer.

Run
Save
Cancel

2.3 Access the Camera in WAN

2.3.1 Static IP Addresses

Users with static IP addresses after you have finished connecting the camera using the LAN IP address and port forwarding, you can access the camera directly from Internet using the WAN IP address and port number

How to Obtain the WAN IP address from a public website ?

To obtain your WAN IP address, enter the following URL in your browser: <http://www.whatismyip.com>. The web page at this address will show you the current WAN IP.



Access your IP Camera from the Internet

You can access the IP Camera from the Internet (remote access). Enter the WAN IP address and port number in your standard browser. For example, you would enter `http:// 183.37.28.254:88`

2.4 Using the VLC Player

This camera supports RTSP streaming, here you can view the camera using VLC player.

RTSP URL [rtsp:// \[user name\]\[:password\]@IP:port number/videosream](rtsp:// [user name][:password]@IP:port number/videosream)

The part in the square brackets may be omitted.

user name & password:

The user name and password to access the camera. This part can be omitted.

IP: WAN or LAN IP address.

port number: If there is the RSTP port number on the Port page, you must only use RTSP port number. otherwise, you must only use http port number.

Videostream: Here support two modes: videoMain and videoSub. When the network speed is bad, here you had better select videoSub.

For example:

IP: 192.168.1.11

Port number: 88

User name: admin

Password: 123

Here I can enter one of the following URLs in the VLC.

1. rtsp://admin:123@192.168.1.11:88/videoMain
2. rtsp:// @192.168.1.11:88/videoMain
3. rtsp://:123@192.168.1.11:88/videoMain
4. rtsp://admin@192.168.1.11:88/videoMain

Open the VLC, and go to Media Open Network Stream option, then enter the URL into VLC.

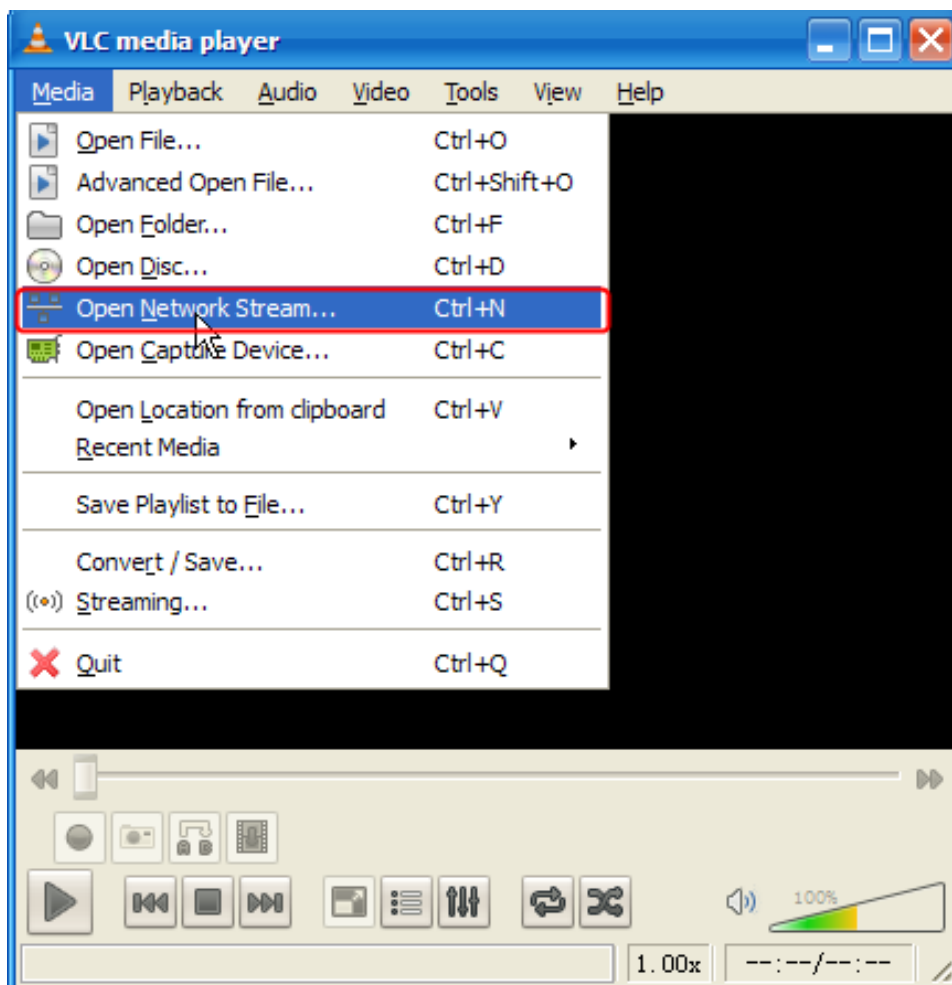

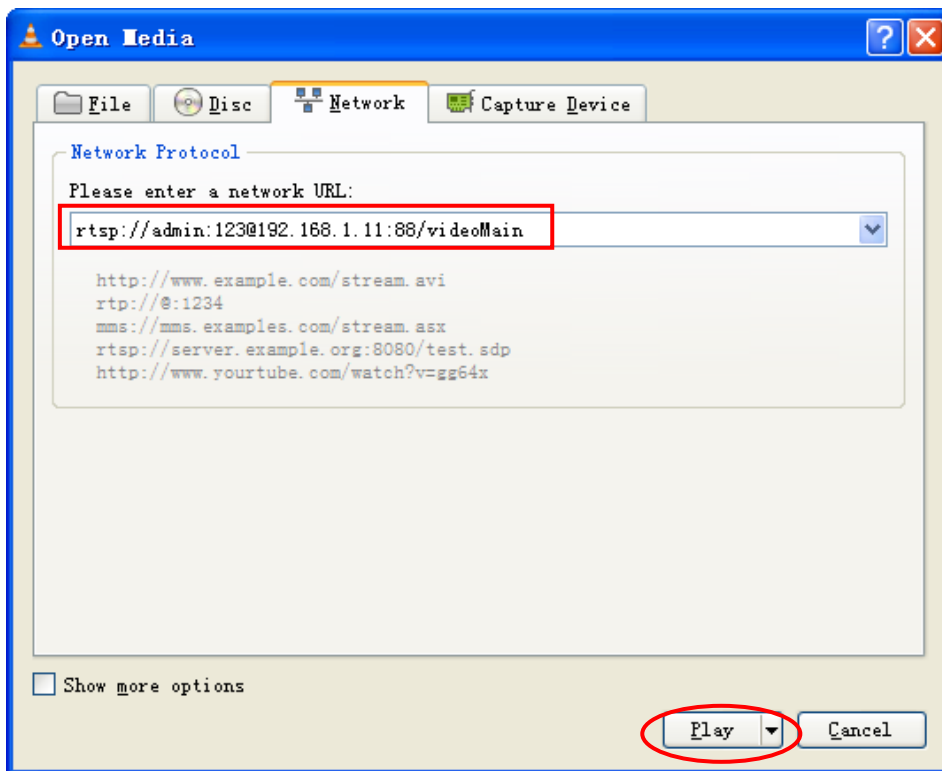

Sometimes you may need to enter the user name and password again. Click OK and you can see the real-time preview.

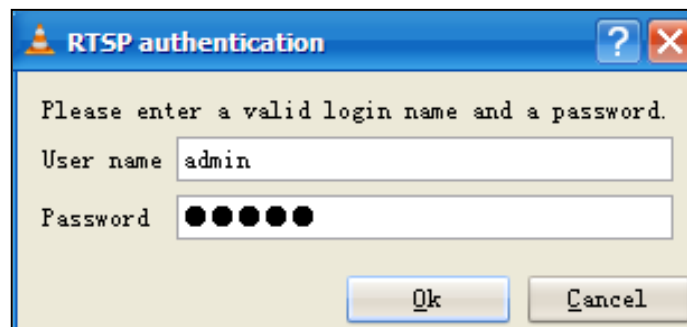

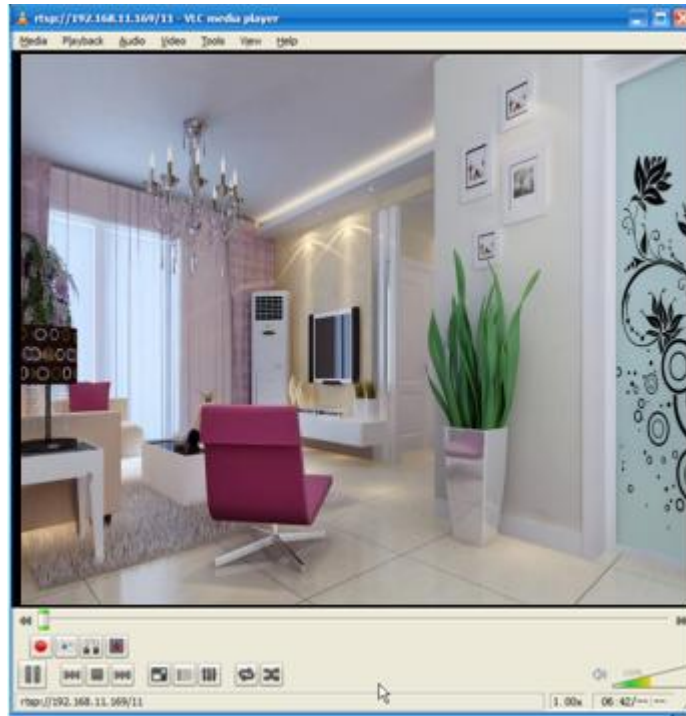

NOTE: If you modify the camera's username or password, you had better reboot the camera, or else the new username and password cannot take effect when you enter the authentication in the VLC.

2.5 IP Camera Connection to the Server

Device supports ONVIF 2.2.1 protocol, You can easily access the NVR with ONVIF or server with ONVIF.

3 Surveillance Software GUI

Please refer to the [2.1 Hardware Connection & Software Installation](#) if you install the camera for the first time. You can start to learn about software operation after finish quick installation.

3.1 Login Window

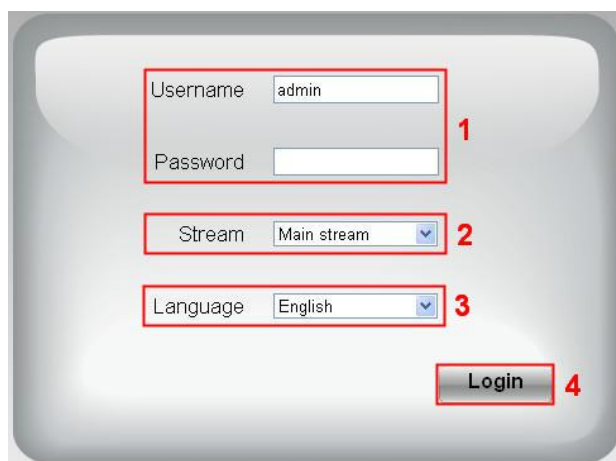

Section1 Enter the Username and password

The default administrator username is admin with no password, please change the password at first using and prevent unauthorized users login the camera.

Section2 Stream

The camera supports two stream modes: Main stream and sub stream. If you want to access the camera form LAN, here you can select Main stream. If you want to access the camera from Internet, here we recommend sub stream.

NOTE: When the network bandwidth is bad you'd better select Sub Stream and the video will be more fluent.

Section3 Select the language

You can select the language you need by clicking on the language dropdown list.

Section4 login the camera

Click **Login** button.

NOTE: When setting up your camera for the first time, it will request that you modify the default username / password if both are still set to default. Input the new username and password, click **Modify** to complete the modification. You will now use the new username and password to login the camera in the future.

Username

New username

New password

Security Level

Confirm the password

After logging in for the first time, you will go to **Setup Wizard** automatically. Here you can set the basic parameters of camera, such as camera name, camera time, IP configuration.

Setup Wizard

Setup Wizard - Start

Follow the guide to set your camera, click "Next" to start.
Please click the menu on the left for more settings.

Country: Select the country.

Setup Wizard

Step 1 of 4 - country

country

Please select the country where you live to ensure a better video experience for you.

Device Name: You could give name for your camera.

Setup Wizard

Step 2 of 5 - Camera Name

Camera Name

The maximum Device Name length is 20, support English, numbers, letters and symbols

System Time: Select the time zone you need to set the date, time, format, etc.

IP: Set IP address of the camera. You could choose to obtain an IP automatically or set the IP address according to your needs.

Setup Wizard

Step 4 of 4 - IP Configuration

Obtain IP From DHCP

IP Address	192.168.1.6
Subnet Mask	255.255.255.0
Gateway	192.168.1.1
Primary DNS Server	192.168.8.8
Secondary DNS Server	211.162.78.2

Previous Finish

Click **Finish** to finish setting.

3.2 Surveillance Window

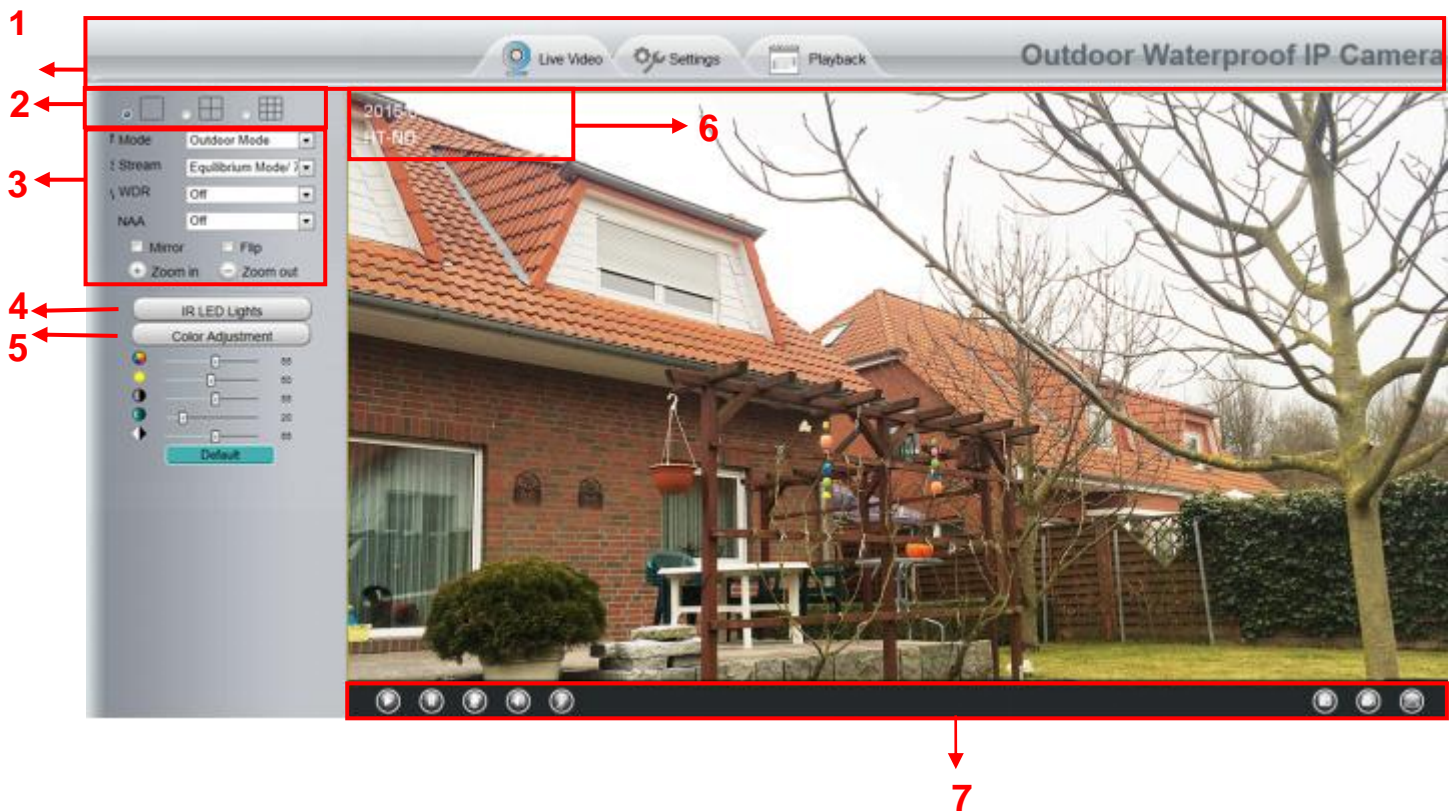

Section 1 Live Video / Settings Buttons / Playback

 **LiveVideo**: Path to surveillance window. Click this button and back to the surveillance window

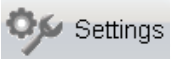
 **Settings**: Path to Administrator Control Panel. Click it, and it will lead to Administrator Control Panel and do advanced settings.

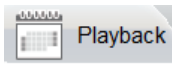

: Path to playback window, click it to search / playback the records.

Section 2 Multi-Device Window

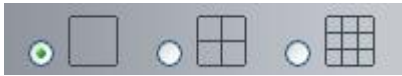

The firmware inside the camera supports up to maximum of 9 cameras being monitoring at the same time. You can add other cameras in multi-camera panel.

Section 3 Mode / Stream / WDR / NAA / Mirror / Flip Buttons / Zoom in / out

Mode

- 1) 50Hz -----Indoor surveillance (Region: Europe, China)
- 2) 60Hz -----Indoor surveillance (Region: USA, Canada)
- 3) Outdoor Mode-----Outdoor surveillance

Stream

The default stream supports multiple modes, For example: HD Mode / 1080P / 25fps / 4M meanings: **Stream type / Resolution / Maximum frame rate / Bit rate**. (Different models support different specific mode.)

1) Stream type no. Identify the stream type.

2) Resolution

The bigger the resolution, the better of the image quality is. If you are accessing the camera via internet and want to get more fluent video streaming, please select resolution VGA.

3) Maximum frame rate

The maximum frame rate is 30 fps. You should lower frame rate when the bandwidth is limited. Normally, when the frame rate above 15, you can achieve fluently video. The maximum frame rate for each model is different, please refer to [6.3 Specification](#).

4) Bit Rate

Generally speaking, the larger the bit rate is, the clearer video will become. But the bit rate configuration should combine well with the network bandwidth. When the bandwidth is very narrow, and bit rate is large, that will lead to video cannot play well.

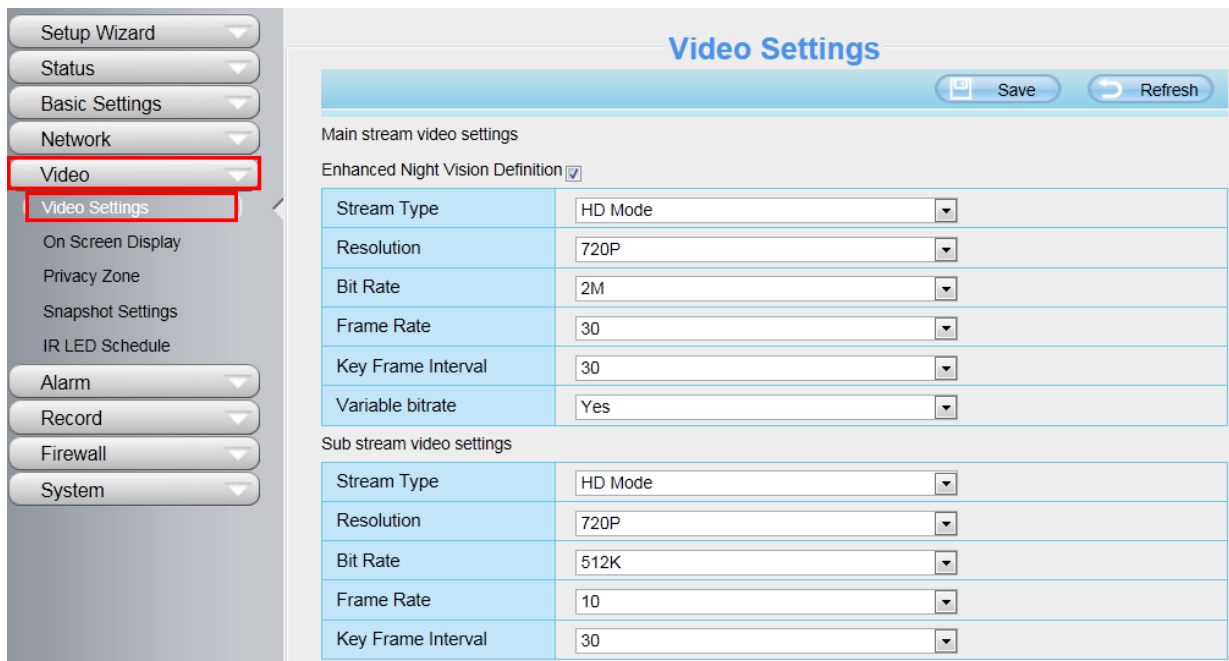

You can reset the stream type on **Settings > Video > Video Settings** panel.



WDR: WDR stands for High Dynamic Range. It usually refers to the method of capturing images having "greater dynamic range between the lightest and darkest areas of an image than current standard digital imaging methods or photographic methods". You can select **On** from the dropdown list under sunlight or with bright background.

NAA: NAA (Network Auto-Adaptability) can make IP Camera changing the real-time rate to adapt different network conditions, which can supply better preview experience. It is OFF as default.

Zoom In or Zoom Out

Device Support 8x zoom feature, click  or , The focal length of the camera lens will be larger or shrink, you can adjust the focus distance to the target object size, access to high-definition screen.

Section 4 IR LED Lights

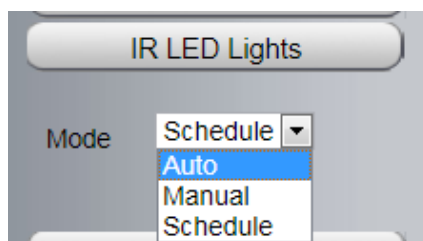

Click Infra led and there are three modes to adjust the infrared led: Auto, Manual and Schedule.

Auto: Select it and the camera will adjust the infra led (on or off) automatically.

Manual: Select it and turn off the infra led manually.

Schedule: Select it and the IR led light will be off at the schedule period. If you want to define or change the IR led lights schedule time, please go to **Settings > Video > IR LED Schedule** page.

Section 5 Image quality settings

In this page, you can tune Hue, Brightness, Contrast, Saturation, and Sharpness to get higher quality.



Section 6 OSD

If you have added time and camera name in the video, you can see it in the live window.

Go to **Settings > Basic settings > Camera name** panel, and you can change another device name. The default device name is anonymous.

Go to **Settings > Basic Settings > Camera time** panel and adjust the device time.

Go to **Settings > Video > On Screen Display** panel, you can add or no add OSD.

Section 7 Play / Stop / Snap / Record / Full screen button



1-----Play Click it to play the video of the camera

2-----Stop Click it to stop the video of the camera

3----- Talk Click the button and the icon will become to , then talk to the microphone that connected with PC, people around the camera can hear your voice if the camera has connected with audio output device. Click the icon again and stop talking.

4----- Audio Click the button and the icon will become to , you can hear the sound around the camera if the camera has connected with other audio input device through the Audio Input port of the camera, Click the icon again and stop audio.

5----- Volume click it to open the volume control.

6----- Snap Click it to make snapshot and it pop up a window which picture you snapshot, right click in the window and save the picture to anywhere you want.

7----- Record Click the icon  and the camera start recording, you can see a green dot in the live window. Click again and stop recording. The default storage path is C:\IPCamRecord. You can change the storage path: Go to **Settings > Record > Storage Location** panel.

8-----Full Screen Click it to make full-screen, or you can double click the surveillance screen to make full-screen. Double click again and exit full-screen.

Onscreen Mouse Control

Right click the mouse and you can full screen and Zoom up.



Full Screen: Select it and Click it to make full-screen, press ESC and exit full-screen.

Zoom Up / Down: Click it and the live view will be digital zoomed up, then click Zoom Down and the live view back to original size.

NOTE: For Mac OS, the plugin cannot support Onscreen Mouse function, so you cannot allow to use it.

4 Advanced Camera Settings

Click the button **Settings**, goes to Administrator Control Panel to make advanced camera settings.

4.1 Setup Wizard

After logging in for the first time, you will go to "Setup Wizard" automatically. Here you can set the basic parameters of camera, such as the camera name, camera time, IP configuration and so on.

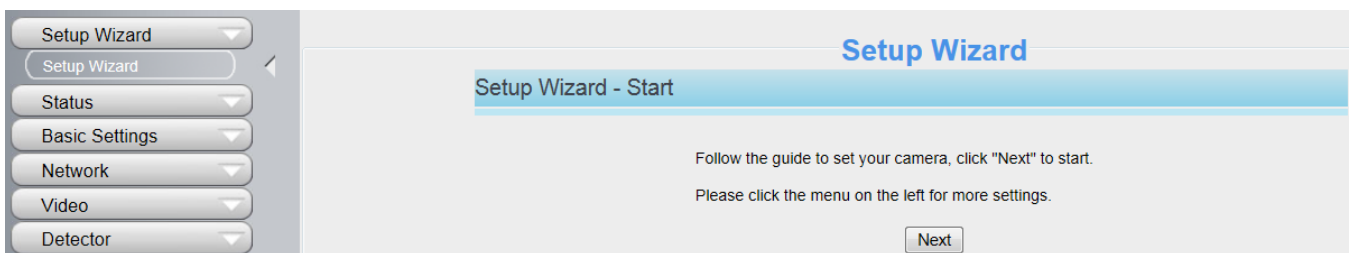

4.2 Device Status

Device Status contains four columns: Device Information, Device Status, Session Status and Log, it will show you various information about your camera.

4.2.1 Device Information

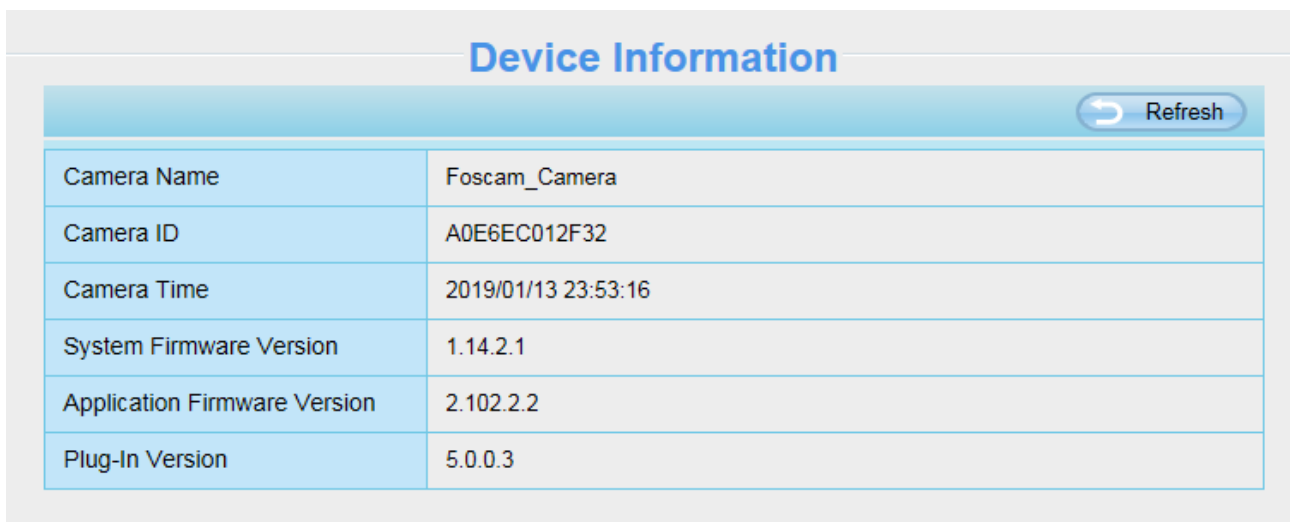

Device Information	
Camera Name	Foscam_Camera
Camera ID	A0E6EC012F32
Camera Time	2019/01/13 23:53:16
System Firmware Version	1.14.2.1
Application Firmware Version	2.102.2.2
Plug-In Version	5.0.0.3

Camera Name: The Device Name is a unique name that you can give to your device to help you identify it. Click Basic Settings and go to Device Name panel where you can change your camera name. The default device name is anonymous.

Camera ID: Display the MAC address of your camera. For example Device ID is A0E6EC012F32, the same MAC ID sticker is found at the bottom of the camera.

Camera Time: The system time of the device. Click Basic Settings and go to Camera Time panel and adjust the time.

System Firmware Version: Display the System Firmware version of your camera.

Application Firmware Version: Display the application firmware version of your camera.

Plug-In Version: Display the plug-in version of your camera

4.2.2 Device Status

On this page you can see device status such as Alarm status, NTP status, IR LED Status and so on.

Device Status	
 Refresh	
Motion alarm status	No alarm
Sound alarm status	Disabled
Human Detection Alarm Status	Disabled
Recording Status	Not Recording
SD Card Status	No SD card
SD Card Free Space	0KB
SD Card Total Space	0KB
NTP Status	Failed
WiFi Status	Not connected
IR LED Status	On

4.2.3 Session Status

Session status will display who and which IP is visiting the camera now.

Session Status	
 Refresh	
Username	IP Address
1	192.168.31.29

4.2.4 Log

The log record shows who and which IP address accessed or logout the camera and when.

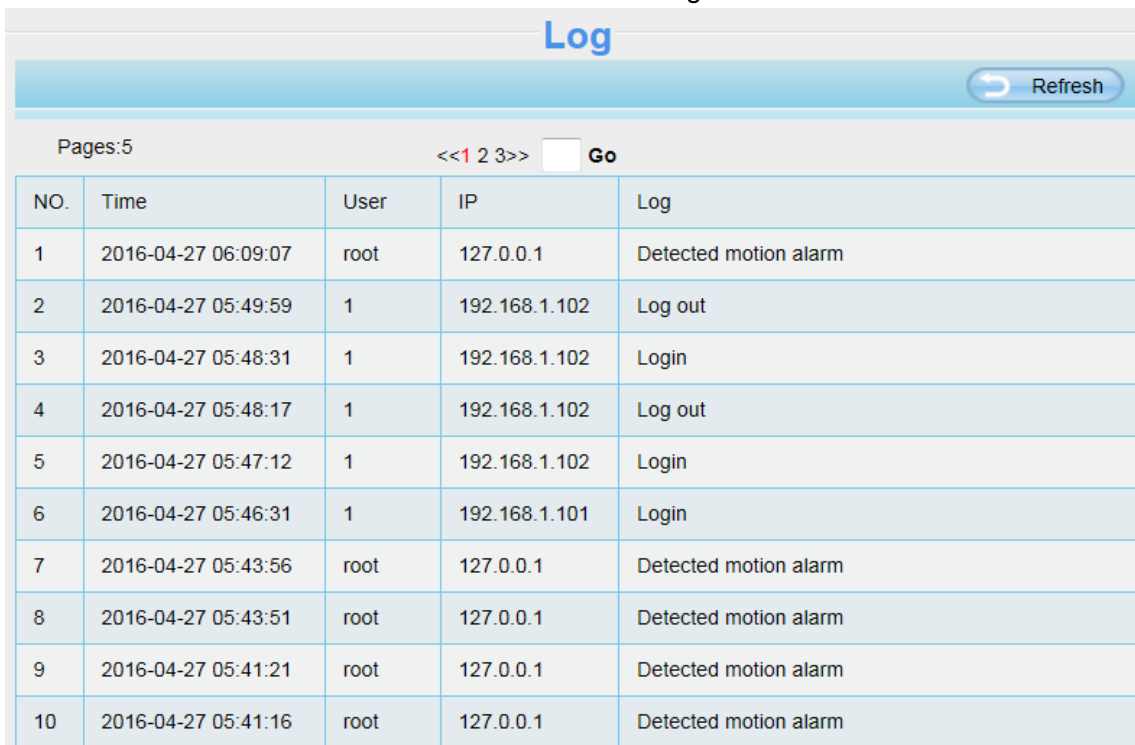

The screenshot shows a web interface titled "Log". At the top right, there is a "Refresh" button. Below the title, it says "Pages:5" and a pagination control with "<< 1 2 3 >>" and a "Go" button. The main content is a table with 5 columns: NO., Time, User, IP, and Log. The table contains 10 rows of log entries.

NO.	Time	User	IP	Log
1	2016-04-27 06:09:07	root	127.0.0.1	Detected motion alarm
2	2016-04-27 05:49:59	1	192.168.1.102	Log out
3	2016-04-27 05:48:31	1	192.168.1.102	Login
4	2016-04-27 05:48:17	1	192.168.1.102	Log out
5	2016-04-27 05:47:12	1	192.168.1.102	Login
6	2016-04-27 05:46:31	1	192.168.1.101	Login
7	2016-04-27 05:43:56	root	127.0.0.1	Detected motion alarm
8	2016-04-27 05:43:51	root	127.0.0.1	Detected motion alarm
9	2016-04-27 05:41:21	root	127.0.0.1	Detected motion alarm
10	2016-04-27 05:41:16	root	127.0.0.1	Detected motion alarm

Reboot the camera and clear the log records.

4.3 Basic Settings

This section allows you to configure your Camera Name, Camera Time, Mail, User Accounts and Multi-Device.

4.3.1 Camera Name

Default alias is anonymous. You can define a name for your camera here such as apple. Click **Save** to save your changes. The alias name cannot contain special characters.

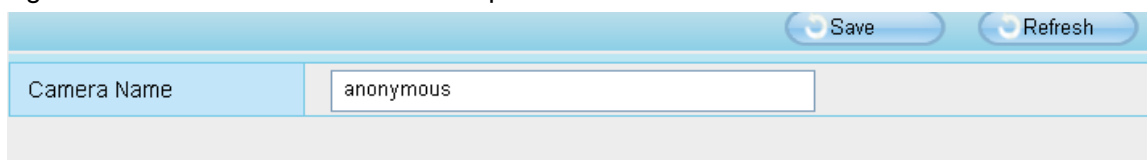

The screenshot shows a configuration form for the Camera Name. At the top right, there are "Save" and "Refresh" buttons. The form has a label "Camera Name" and a text input field containing the value "anonymous".

4.3.2 Camera Time

This section allows you to configure the settings of the internal system clocks for your camera.

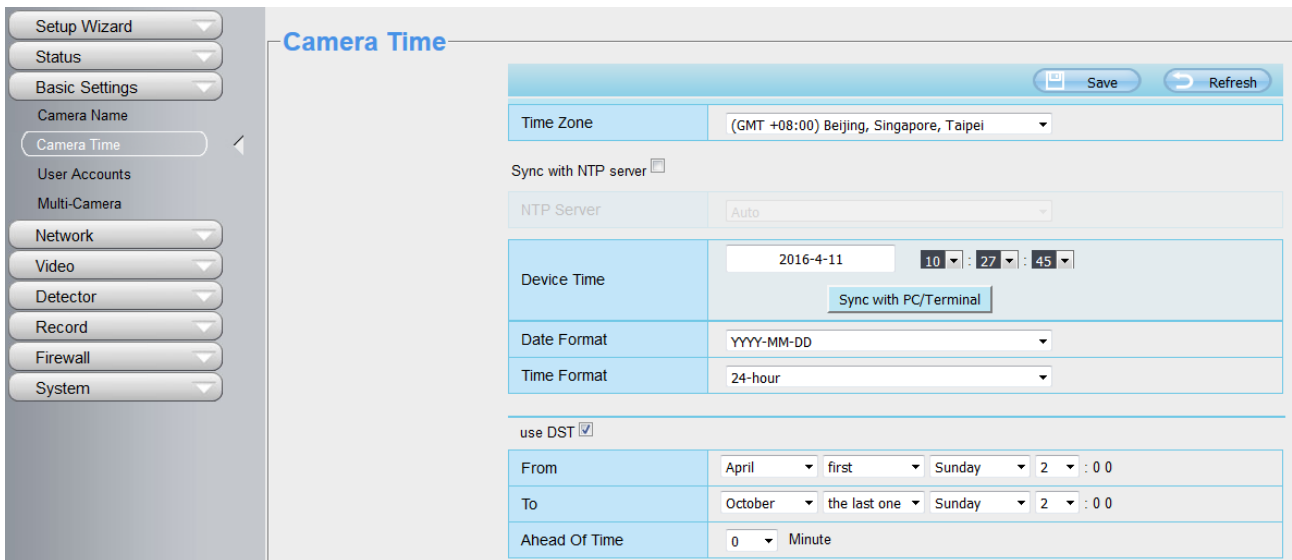

Time Zone: Select the time zone for your region from the drop-down menu.

Sync with NTP server: Network Time Protocol will synchronize your camera with an Internet time server.

Choose the one that is closest to your camera.

Sync with PC/Terminal: Select this option to synchronize the date and time of the Network Camera with your computer.

Manually: The administrator can enter the date and time manually. Please select the date and time format.

use DST: Select the **use DST**, then select the daylight saving time from the drop-down menu.

Click Save button to submit your settings.

NOTE: If the power supply of camera is disconnect, you need set the camera's time again.

4.3.3 User Accounts

Here you can create users and set privilege, **visitor**, **operator** or **administrator**. The default administrator user accounts are admin with a blank password.

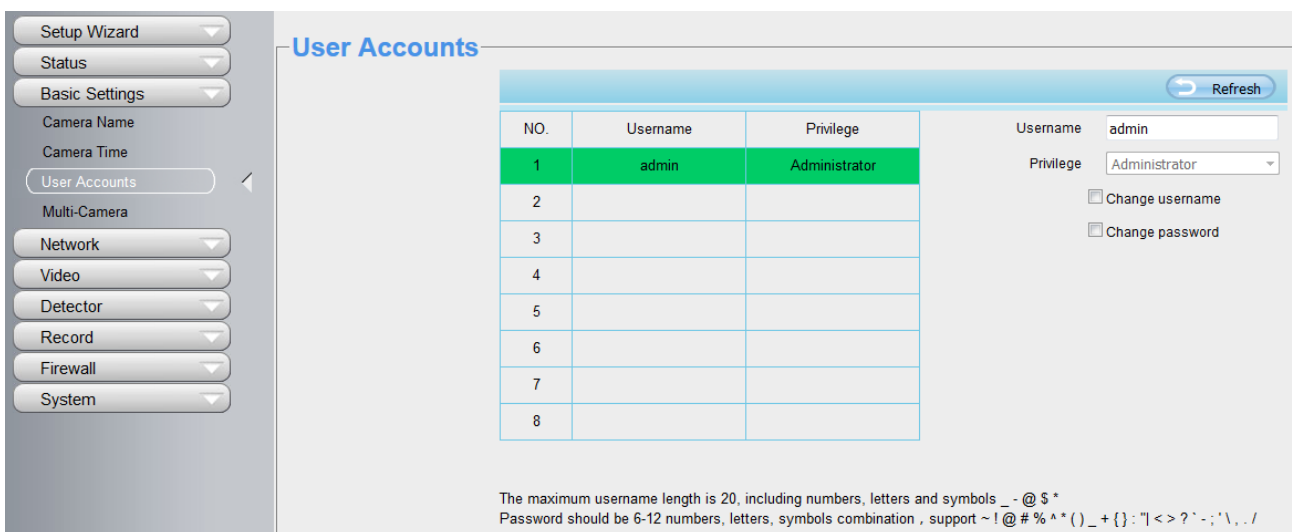

How to change the password?

Firstly, select the account which you want to change the password, then select **Change password**, enter the old password and the new password, lastly click modify to take effect.

Refresh

NO.	Username	Privilege
1	admin	Administrator
2		
3		
4		
5		
6		
7		
8		

Username:

Password:

New password:

Security Level:

Confirm the password:

Privilege:

Change username

Change password

Modify

The maximum username length is 20, including numbers, letters and symbols _ - @ \$ *
 Password should be 6-12 numbers, letters, symbols combination , support ~ ! @ # % ^ * () _ + { } : " | < > ? ` - ; ' \ , . /

How to add account ?

Select one blank column, then enter the new user name, password and privilege, last click Add to take effect. You can see the new added account on the Account list.

Refresh

NO.	Username	Privilege
1	admin	Administrator
2		
3		
4		
5		
6		
7		
8		

Username:

Password:

Security Level:

Confirm the password:

Privilege:

Add

The maximum username length is 20, including numbers, letters and symbols _ - @ \$ *
 Password should be 6-12 numbers, letters, symbols combination , support ~ ! @ # % ^ * () _ + { } : " | < > ? ` - ; ' \ , . /

NO.	Username	Privilege
1	admin	Administrator
2	Test	Visitor
3		
4		
5		
6		
7		
8		

Username:

Privilege:

Change username

Change password

The maximum username length is 20, including numbers, letters and symbols _ - @ \$ *
 Password should be 6-12 numbers, letters, symbols combination, support ~ ! @ # % ^ * () _ + { } : " | < > ? ` - ; ' \ , . /

Delete: Select the account which you want to delete, then click Delete button to take effect.

NOTE: The default administrator account cannot be deleted, but you can add other administrator users.

4.3.4 Multi-Camera

If you want to view multi-surveillance screens on one window, you need to login one camera, and set it as the main device, and do Multi-Device Settings, add other cameras to the first one camera. Before you do multi-cams settings, you need to assign different port such as 81, 82, 83, 84, 85, 86, 87, 88 to the cameras if there is 8 cameras installed.

The firmware within the camera can support a maximum of 9 devices monitoring all at the same time. This page you can both add FOSCAM MJPEG and H.264 series cameras to the first camera and view multi-surveillance screen on one window.

Add Cameras on LAN

In Multi-Device Settings page, you can see all devices searched in LAN. The 1st Device is the default one. You can add more cameras in the list in LAN for monitoring. The camera's software supports up to 9 IP Cameras online simultaneously. Click The **2nd Device** and click the item in the Device List in LAN, the Alias, Host and Http Port will be filled in the boxes below automatically. Enter the correct username and password then click **Add**. Add more cameras in the same way.

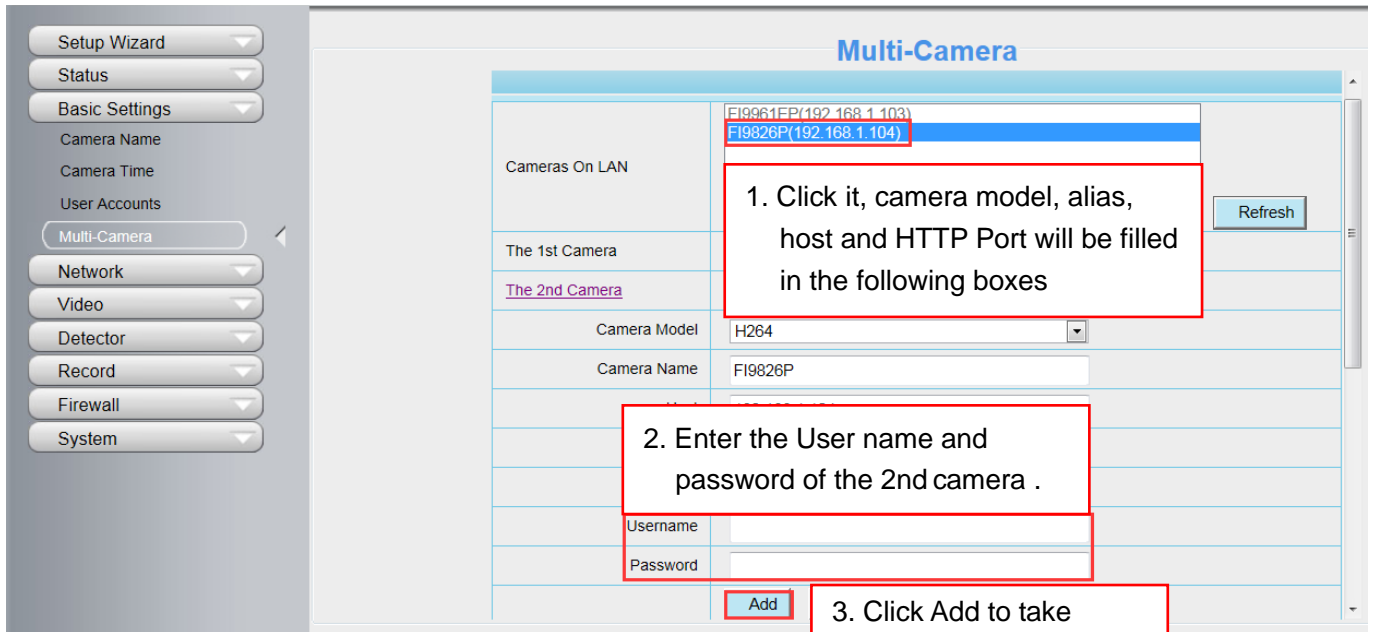

Camera Model: Our Company produces two series cameras: MJ and H.264. Here will show you which series the camera belongs to.

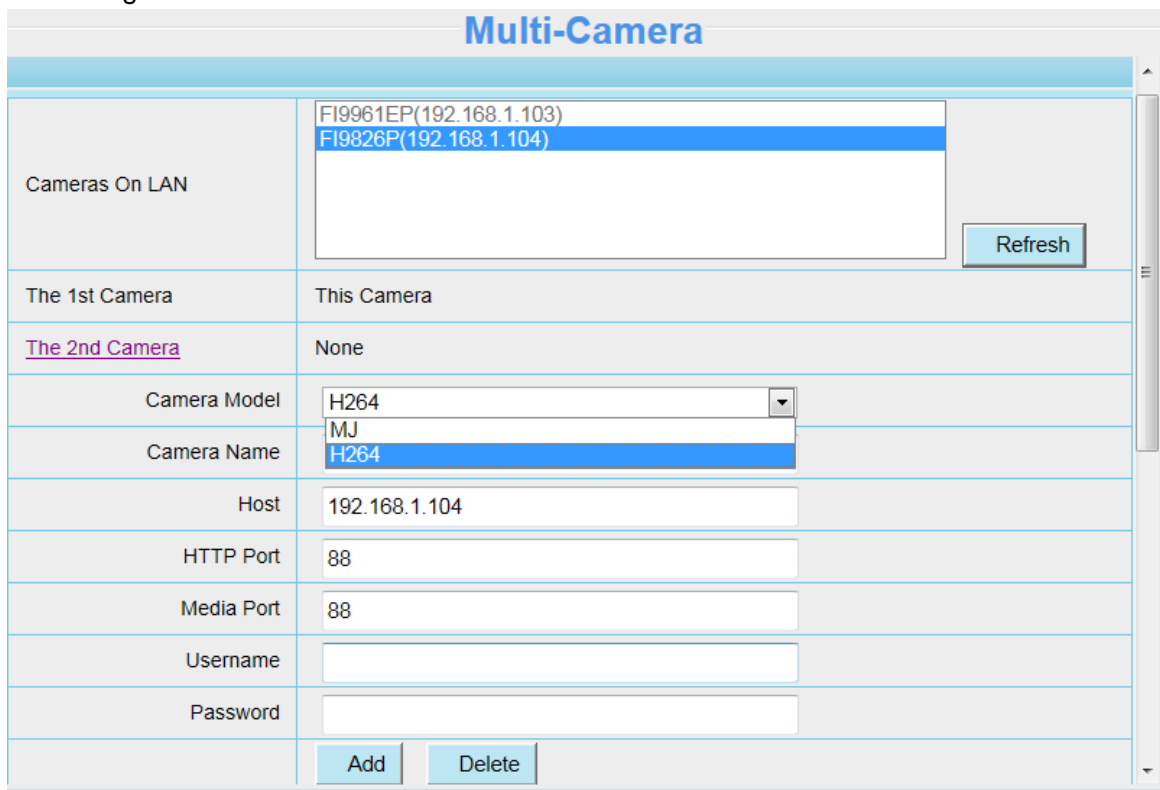

Back to Surveillance Windows, and click Four Windows option, you will see four cameras you added.

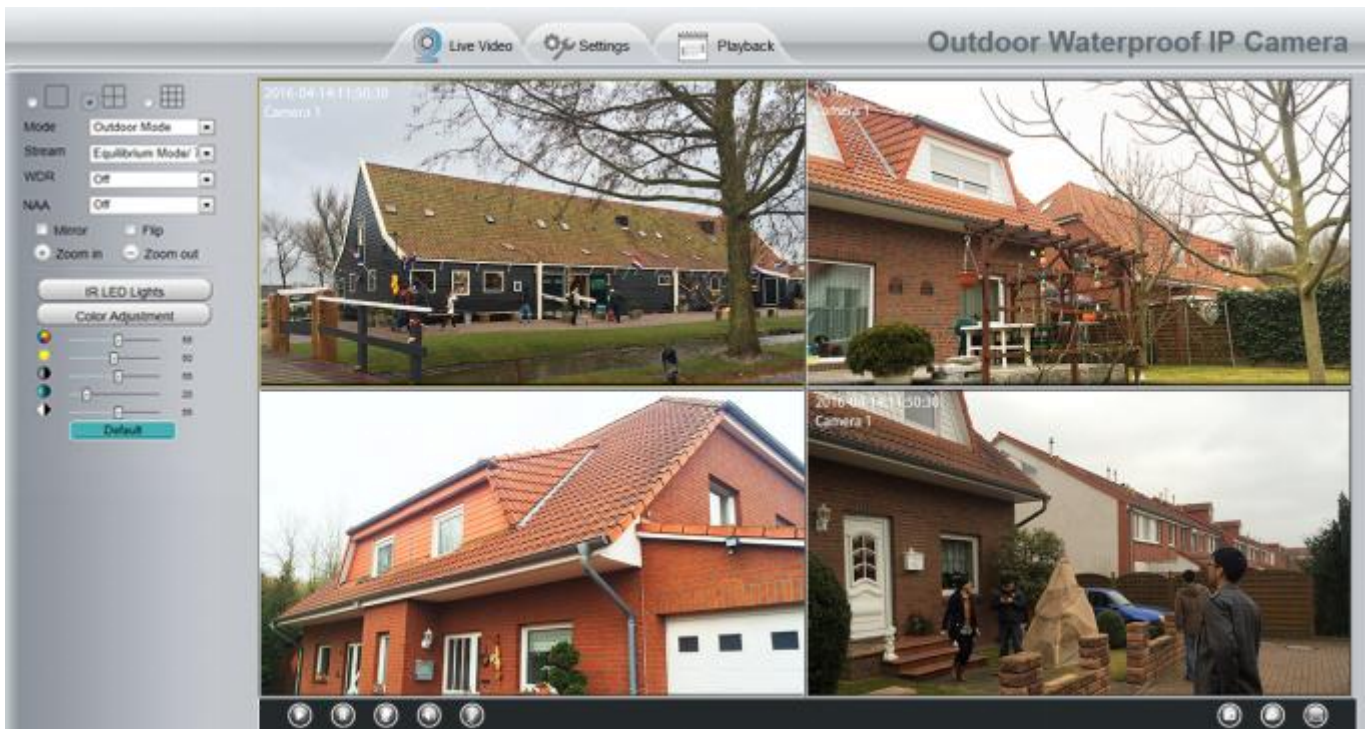

4.3.5 Voice Prompt

On this page, you can enable or disable voice prompt. Select “Yes” to enable or select “No” to disable. If select “Yes”, you can hear the voice prompt after connect the audio output device.

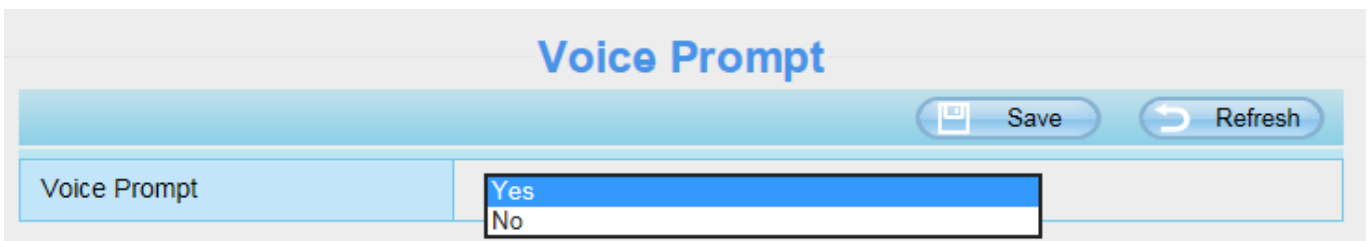

4.4 Network

This section will allow you to configure your camera's IP, Port, Mail Settings and FTP Settings and so on.

4.4.1 IP Configuration

If you want to set a static IP for the camera, please go to **IP Configuration** page. Keep the camera in the same subnet of your router or computer.

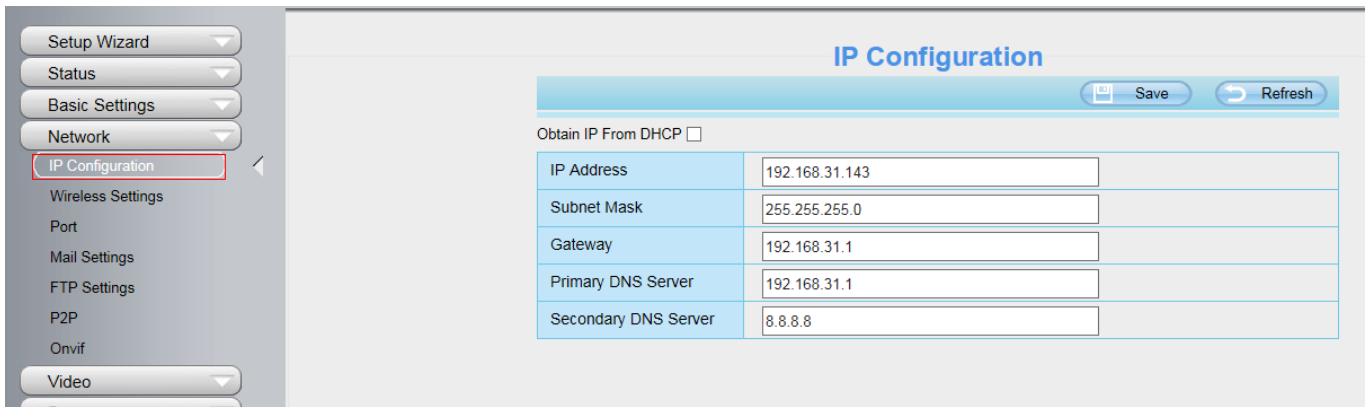

Changing settings here is the same as using the Equipment Search Tool.

It is recommended that you use the subnet mask, gateway and DNS server from your locally attached PC. If you don't know the subnet mask, gateway and DNS server, you can check your computer's local area connection as follows:

Control Panel > Network Connections > Local Area Connections > Choose Support > Details.

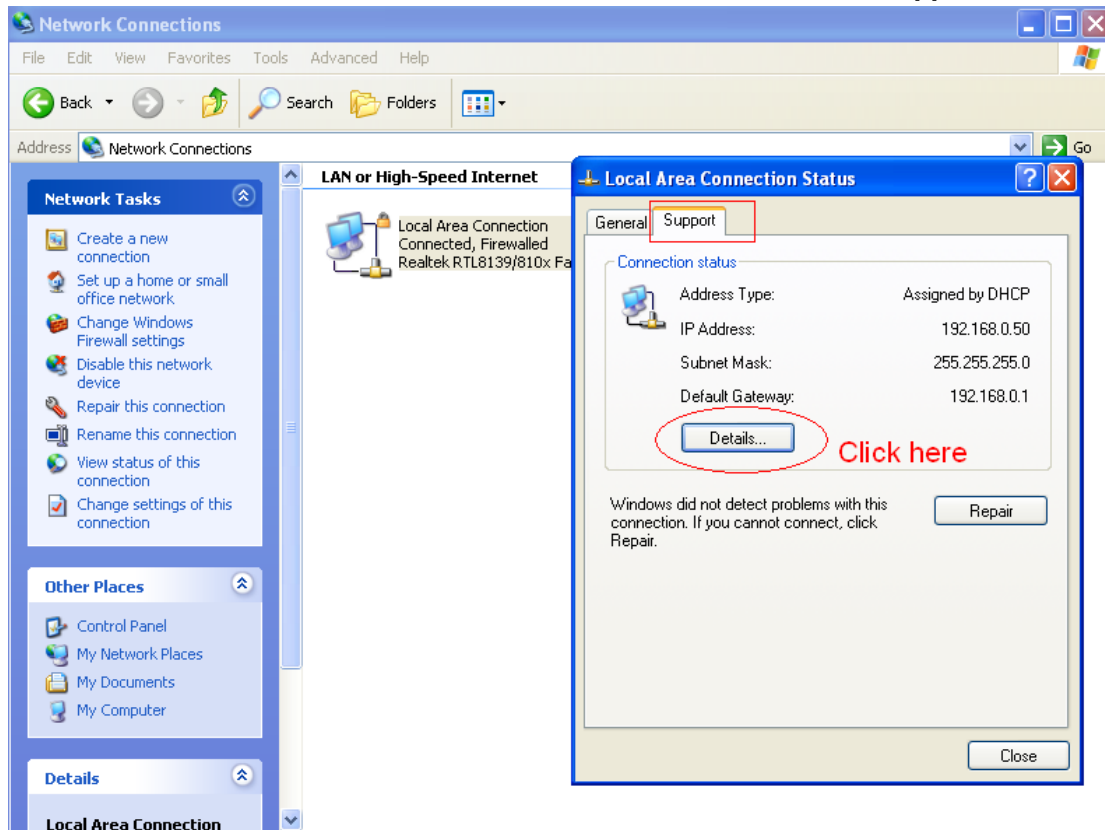

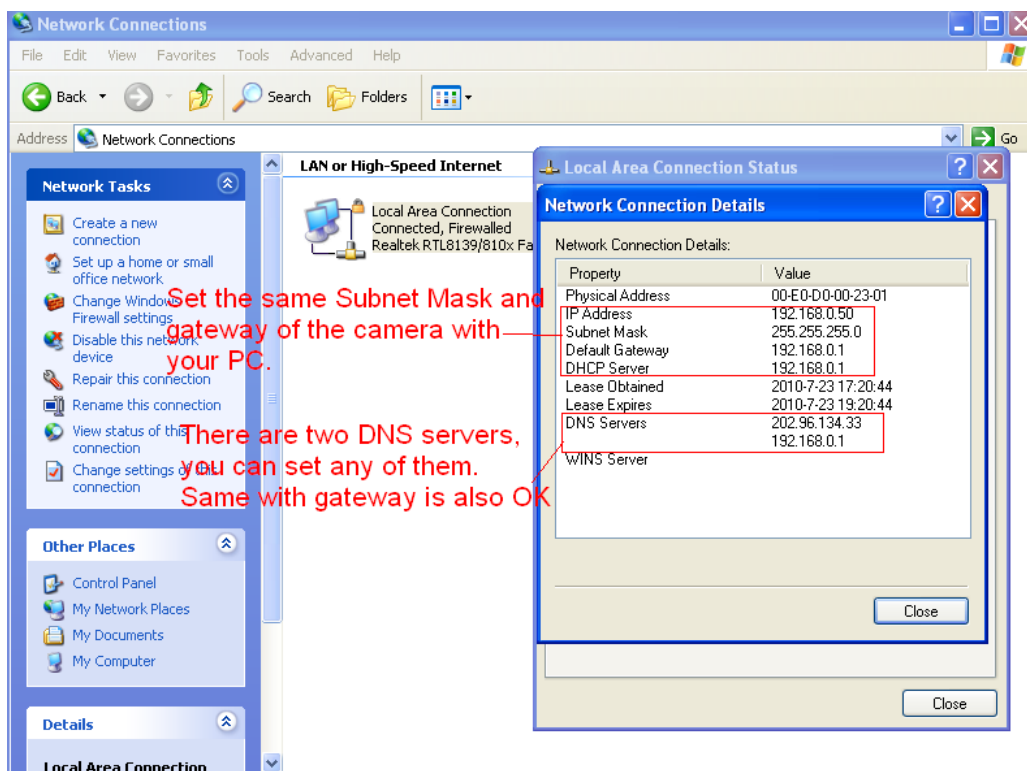

If you don't know the DNS server, you can use the same settings as the Default Gateway.

4.4.2 Mail Settings

If you want the camera to send emails when motion has been detected, here Mail will need to be configured.

5		Save	Refresh
Enable	<input checked="" type="checkbox"/>		
SMTP Server	smtp.gmail.com		
SMTP Port	25		1
Transport Layer Security	STARTTLS	G-Mail only supports TLS at Port 465 and STARTTLS at Port 587 or 25.	
Need Authentication	Yes		
SMTP Username	cuiyao93@gmail.com		2
SMTP Password	Test	6
Sender E-mail	cuiyao93@gmail.com		3
First Receiver	yaoyao@163.com		
Second Receiver			
Third Receiver			4
Fourth Receiver			

1----- SMTP Server / Port / Transport Layer Security Enter SMTP server for sender. SMTP port is usually set as 25. Some SMTP servers have their own port, such as 587 or 465, and Transport Layer Security usually is None. If you use Gmail, Transport Layer Security must be set to TLS or STARTTLS and SMTP Port must be set to 465 or 25 or 587, which port you choose should be decided by which Transport Layer Security you

select.

2-----SMTP Username / password ID account and password of the sender email address

3----- Sender E-mail Mailbox for sender must support SMTP

4----- Receiver Mailbox for receiver need not support SMTP, you can set 4 receivers

5----- Save Click Save to take effect

6----- Test Click Test to see if Mail has been successfully configured.

Click Test to see if Mail has been successfully configured.

The screenshot shows a configuration window for email settings. At the top right, there are 'Save' and 'Refresh' buttons. Below them, an 'Enable' checkbox is checked. The main area is a table with the following fields:

SMTP Server	smtp.gmail.com
SMTP Port	25
Transport Layer Security	STARTTLS <small>G-Mail only supports TLS at Port 465 and STARTTLS at Port 587 or 25.</small>
Need Authentication	No
SMTP Username	yaoyao@gmail.com
SMTP Password	••••••••
Sender E-mail	yaoyao@gmail.com
First Receiver	yaoyao@163.com
Second Receiver	
Third Receiver	
Fourth Receiver	

To the right of the SMTP Password field is a 'Test' button. Next to it is a green 'Success' button, which is highlighted with a red box. To the right of the 'Success' button is a red-bordered box containing the text 'Test result.'.

If the test success, you can see the Success behind the Test, at the same time the receivers will receive a test mail.

If the test fails with one of the following errors after clicking Test, verify that the information you entered is correct and again select Test .

- 1) Cannot connect to the server.
- 2) Network Error. Please try later.
- 3) Server Error.
- 4) Incorrect user or password.
- 5) The sender is denied by the server. Maybe the server need to authenticate the user, please check it and try again.
- 6) The receiver is denied by the server. Maybe because of the anti-spam privacy of the server.
- 7) The message is denied by the server. Maybe because of the anti-spam privacy of the server.
- 8) The server does not support the authentication mode used by the device.

4.4.3 FTP Settings

If you want to upload record images to your FTP server, you can set **FTP Settings**.

<div style="text-align: right;"> <input type="button" value="Save"/> <input type="button" value="Refresh"/> </div>	
FTP Server	<input type="text" value="ftp://192.1681.8.150"/> Example:ftp://192.168.1.103/dir The maximum length of the address is 127, does not support the character & =
Port	<input type="text" value="21"/>
FTP Mode	PASV
Username	<input type="text" value="user"/> The maximum length of the user name is 63, support numbers, letters and symbols _ @ \$ * - , . # !
Password	<input type="password" value="••••••"/> The maximum password length is 63, including numbers, letters and symbols ~ ! @ # \$ % ^ * () _ + { } : " < > ? ` - ; ' \ , . /
<input type="button" value="Test"/>	<input type="text" value="FTP server address error"/>

FTP server: If your FTP server is located on the LAN, you can set as Figure as above. If you have an FTP server which you can access on the internet, you can set as below.

<div style="text-align: right;"> <input type="button" value="Save"/> <input type="button" value="Refresh"/> </div>	
FTP Server	<input type="text" value="ftp://ftp.mgenseal.com"/> Example:ftp://192.168.1.103/dir The maximum length of the address is 127, does not support the character & =
Port	<input type="text" value="21"/>
FTP Mode	PASV
Username	<input type="text" value="user"/> The maximum length of the user name is 63, support numbers, letters and symbols _ @ \$ * - , . # !
Password	<input type="password" value="••••••"/> The maximum password length is 63, including numbers, letters and symbols ~ ! @ # \$ % ^ * () _ + { } : " < > ? ` - ; ' \ , . /
<input type="button" value="Test"/>	<input type="text" value="Success"/>

Port: Default is port 21. If changed, external FTP client program must change the server connection port accordingly.

FTP Mode: Here supports two modes: PORT and PASV.

Username / password: The FTP account and password.

Click Save to take effect.

Click Test to see if FTP has been successfully configured.

4.4.4 P2P

Access the camera by smart phone (Android or iOS operating system), please refer to the *Quick Setup Guide*. First of all, you need to open the P2P function of the camera at **Settings > Network > P2P**.

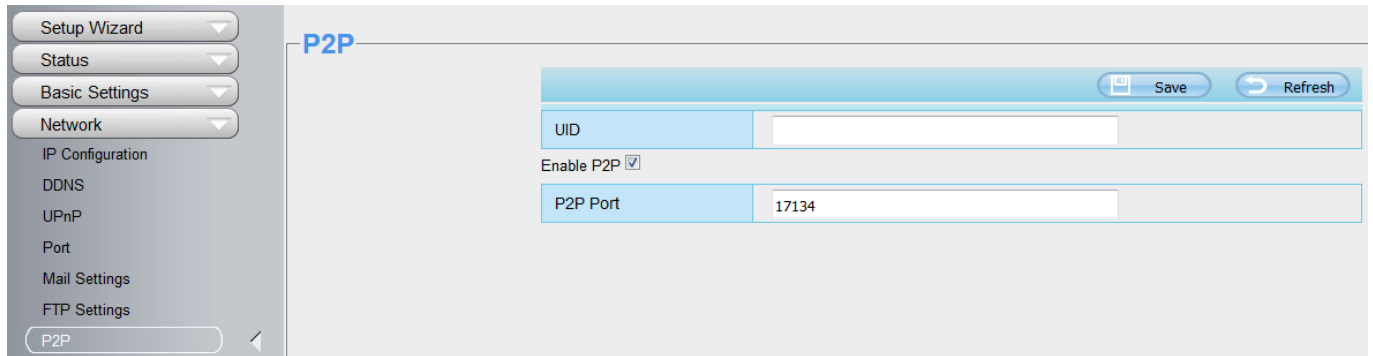

4.5 Video

This section allows you to configure Video stream settings, On screen display and Snapshot settings.

4.5.1 Video Settings

There are two ways to set the stream video settings. They are main stream video settings and sub stream video settings.

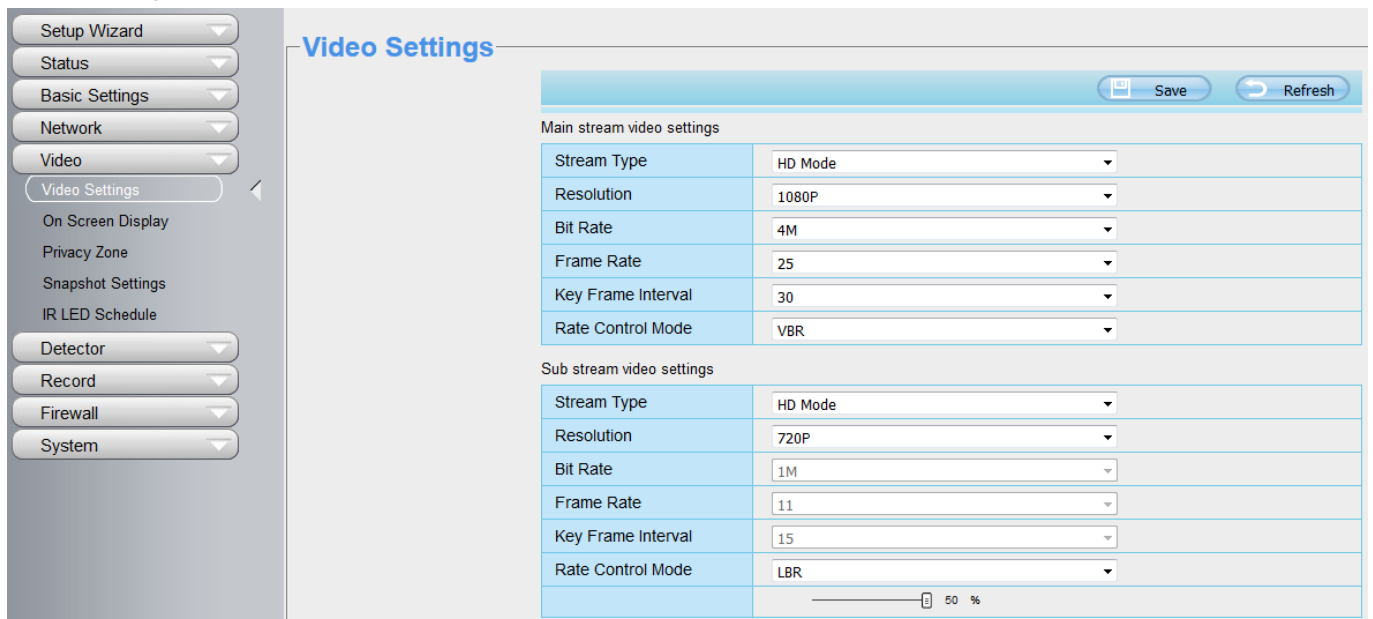

Stream Type: There are four types to identify different streams you have set. If select the HD Mode, the clearer video will become, and it will take up more bandwidth; If select the Smooth Mode, the bandwidth is very narrow, and bit rate is large, that will lead to video can not play well. The Equilibrium Model is a value between HD Mode and Smooth Mode.

Resolution: The camera supports multiple types, For example: 1080P, 960P, 720P, VGA. The higher the resolution is, the clearer video will become. But the code flux will become larger too, and it will take up more bandwidth. (Different models support different specific types.)

Bit Rate: Generally speaking, the larger the bit rate is, the clearer video will become. But the bit rate

configuration should combine well with the network bandwidth. When the bandwidth is very narrow, and bit rate is large, that will lead to video can not play well.

Frame Rate: Note that a larger frame size takes up more bandwidth. You should lower frame rate when the bandwidth is limited. Normally, when the frame rate above 15, you can achieve fluently video. The maximum frame rate for each model is different, please refer to [6.3 Specification](#).

Key Frame Interval: The time between last key frame and next key frame. The shorter the duration, the more likely you will get a better video quality, but at the cost of higher network bandwidth consumption.

Rate Control Mode: There are three rate control modes.

CBR: Constant Bit Rate, it means that the Bit Rate is constant.

VBR: Variable Bit Rate, the camera will change the video bit rate according to the situation, but will not more than the maximum parameter "Bit Rate".

LBR: Low Bit Rate. If you can select the LBR, then you can slide the scroll bar to choose percentage of the bit rate. By reducing the bit rate, so that the camera can obtain a better image at low bandwidth.

4.5.2 On Screen Display

This page is used to add timestamp and device name on the video.

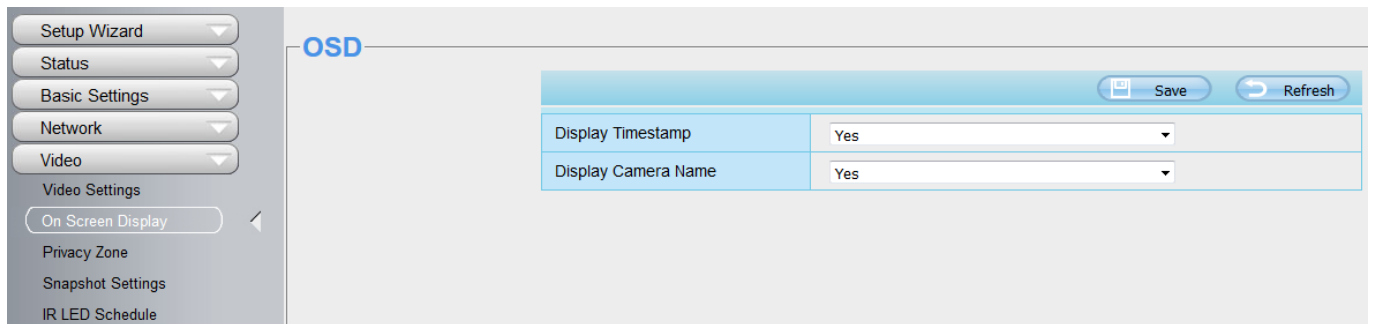

Display Timestamp: There are two options: Yes or NO. Select Yes and you can see the system date on the video.

Display Camera Name: There are two options: Yes or NO. Select Yes and you can see the device name on the video.

4.5.3 Snapshot Settings

In this page you can set the snapshot pictures' image quality and the storage path.

Snapshot Settings

Manual snap Quality	Medium
Pictures Save To	None

Enable timing to capture

Capture interval	2 (1-65535s)
------------------	--------------

All	00	01	02	03	04	05	06	07	08	09	10	11	12	13	14	15	16	17	18	19	20	21	22	23
MON																								
TUE																								
WED																								
THU																								
FRI																								
SAT																								
SUN																								

Manual snap Quality: Low, Middle and High. The higher the quality, the picture will be clearer.

Pictures Save To: FTP or SD card. If you have done FTP and Alarm settings, when alarming, the camera will snap pictures to the FTP or SD card automatically.

If you select the FTP, you can set the file name which the picture save to. For example: file name is "NAME", the snapshot picture is "NAME_20150605-180000.jpg".

Enable timing to capture

To enable capture interval, follow the steps below:

1 Select Enable timing to capture

2 Capture interval: The interval time between two captures.

3 Select the capture time

- Capture anytime

Click the black button up the MON, you will see all time range turn red. When something moving in the detection area at anytime, the camera will capture.

- Specify an capture schedule

Click the week day words, the corresponding column will be selected. For example, click TUE, the all column of TUE turns to red, that means during Tuesday whole day, the camera will capture.

- Press the left mouse and drag it on the time boxes, you can select the serial area,

4 Click Save button to take effect.

4.5.4 IR LED Schedule

On this page you can set the schedule time for switching IR LED lights. When parameter Mode is set to the **Schedule** on the Live **Video** window, At these schedule time, the IR LED lights will be turned off.

4.6 Motion Detection

IP Camera supports **Motion Detection Alarm**, when the motion has been detected, it will send emails or upload images to FTP.

To enable motion detection, follow the steps below:

1 Enable Motion detection

2 Trigger interval--- The interval time between two motion detections. Here supports 5s / 6s / 7s / 8s / 9s / 10s / 11s / 12s / 13s / 14s / 15s. Select one interval time.

3 There are some alarm indicators:

A Camera Sound and PC Sound

If the camera has connected with a speaker or other audio output device, if you select Camera Sound or PC Sound, when the motion has been detected, the people around the camera will hear beep alarm sound.

B Send E-mail

If you want to receive alarm emails when motion is detected, you must select Send E-mail and set Mail Settings first.

C Take Snapshot

If you select this checkbox, when the motion has been detected, the camera will snap the live view window as a still picture and load it to the FTP. Make sure you have set FTP and set FTP as the storage path in Video > Snapshot settings panel.

Time interval: The interval time between two pictures.

D Recording

If you select this checkbox, when the motion has been detected, the camera will recording and load it to the FTP server. Make sure you have set FTP and set FTP as the storage path in Video > Snapshot settings panel.

E Push message to the phone

If you select this checkbox, when the motion has been detected, the camera will push the message to the phone which has been connected the camera.

4 Set Detection Area

Click set detect area and it pop up a window, then you can draw the detection area. Click Back button after settings. When something moving in the detection area, the camera will alarm.

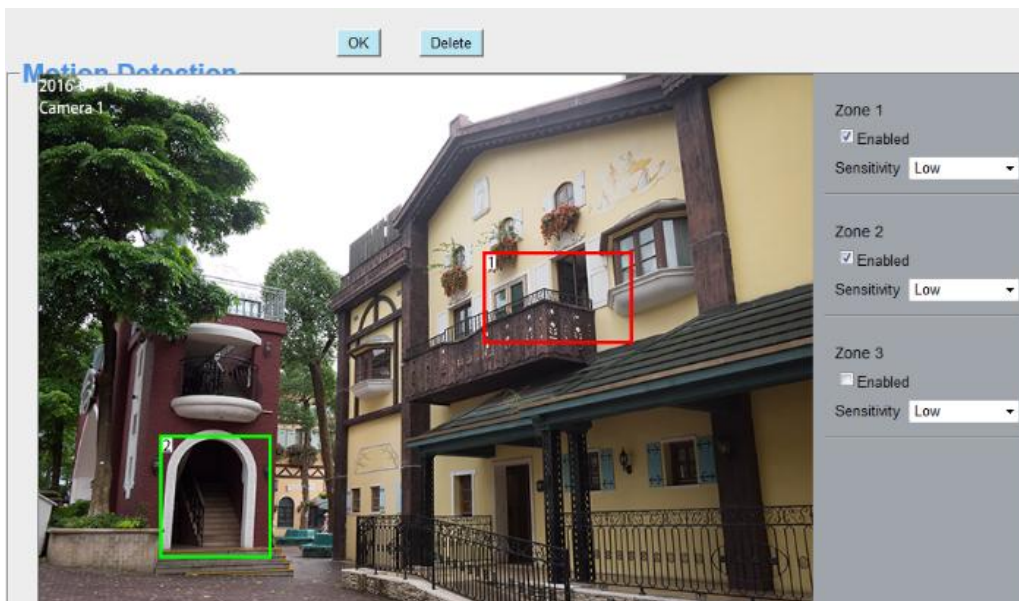

5 Alarm Schedule

- ① Alarm anytime when motion is detected

Click the black button up the MON, you will see all time range turn red. When something moving in the detection area at anytime, the camera will alarm.

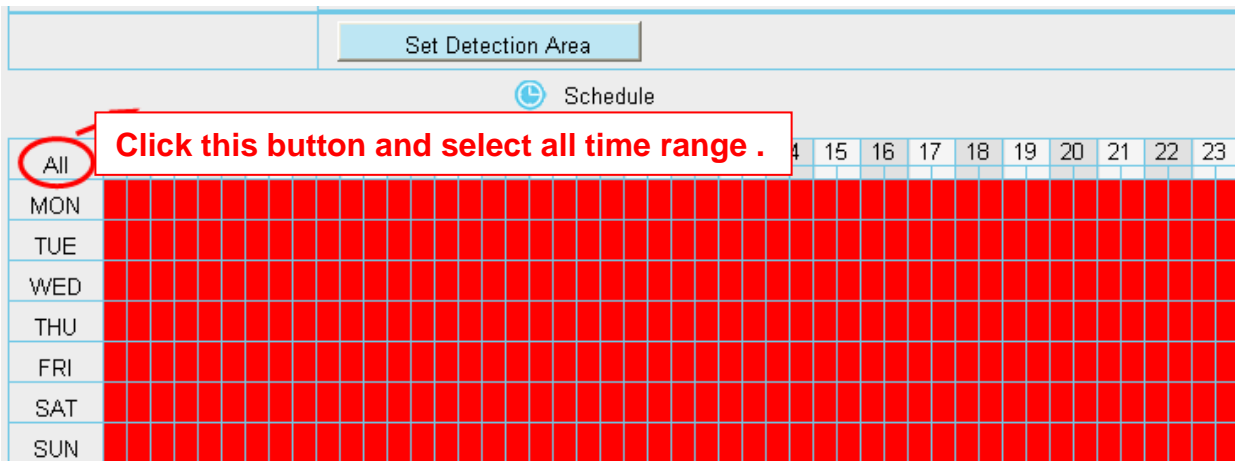

② Specify an alarm schedule

Click the week day words, the corresponding column will be selected. For example, click TUE, the all column of TUE turns to red, that means during Tuesday whole day, when something moving in the detection area, the camera will alarm.

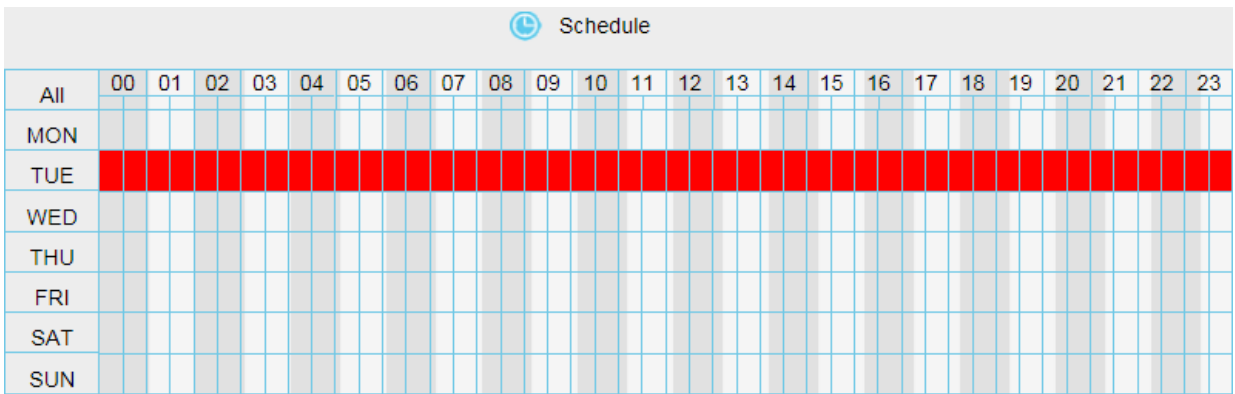

③ Press the left mouse and drag it on the time boxes, you can select the serial area,

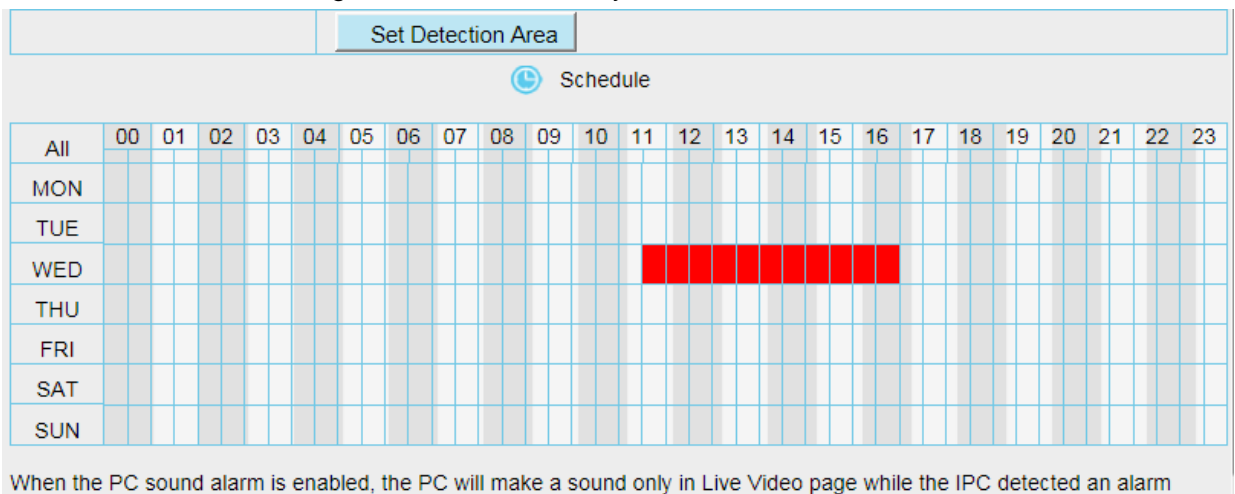

6 Click Save button to take effect. When the motion is detected during the detection time in the detection area, the camera will alarm and adopt the corresponding alarm indicators.

NOTE: You must set the detection area and detection schedule, or else there is no alarm anywhere and anytime.

4.7 Record

4.7.1 Storage Location

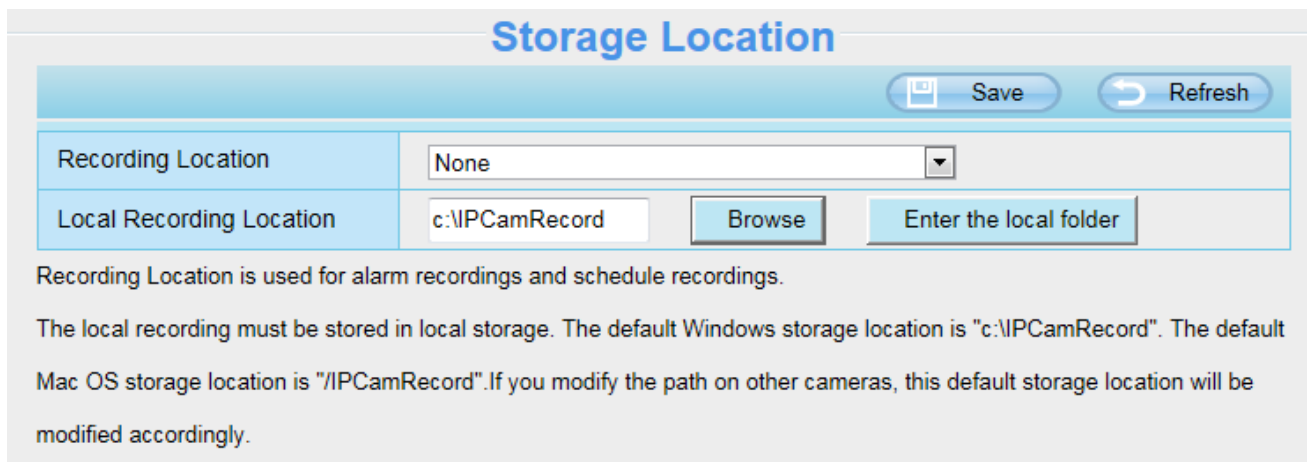

Storage Location

Save Refresh

Recording Location	None
Local Recording Location	c:\IPCamRecord <input type="button" value="Browse"/> <input type="button" value="Enter the local folder"/>

Recording Location is used for alarm recordings and schedule recordings.

The local recording must be stored in local storage. The default Windows storage location is "c:\IPCamRecord". The default Mac OS storage location is "/IPCamRecord". If you modify the path on other cameras, this default storage location will be modified accordingly.

Recording Location: SD card, FTP.

- SD card: The video will be saved in SD card. **Make sure the camera has been inserted the SD card.** On this page, you can see the available space of the SD card.
- FTP: The video will be saved in FTP. Please refer to [4.4.3 FTP Settings](#).

Local Recording Location: For Windows OS, the manual recording path is C:/ IPCamRecord, you can change another one. For MAC OS, the manual recording path is: / IPCamRecord.

Enter the local folder: Click here, you can enter the local folder.

4.7.2 Alarm Record

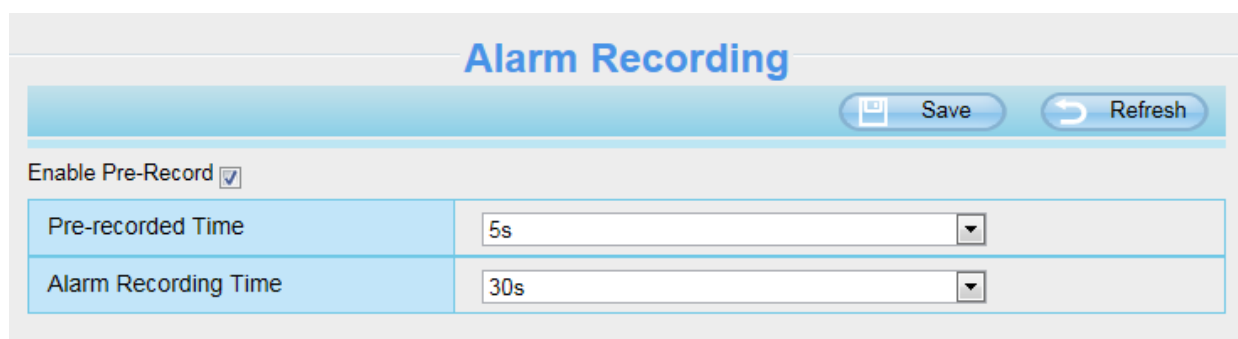

Alarm Recording

Save Refresh

Enable Pre-Record

Pre-recorded Time	5s
Alarm Recording Time	30s

4.7.3 Local Alarm Recording

On this page you can enable local alarm record, and select the local alarm record time.

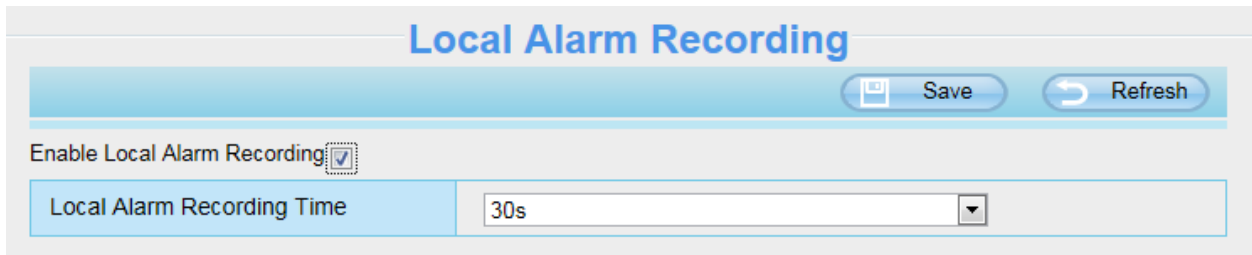

4.7.4 Schedule Recording

When the video is selected as FTP, the device supports scheduled recording.

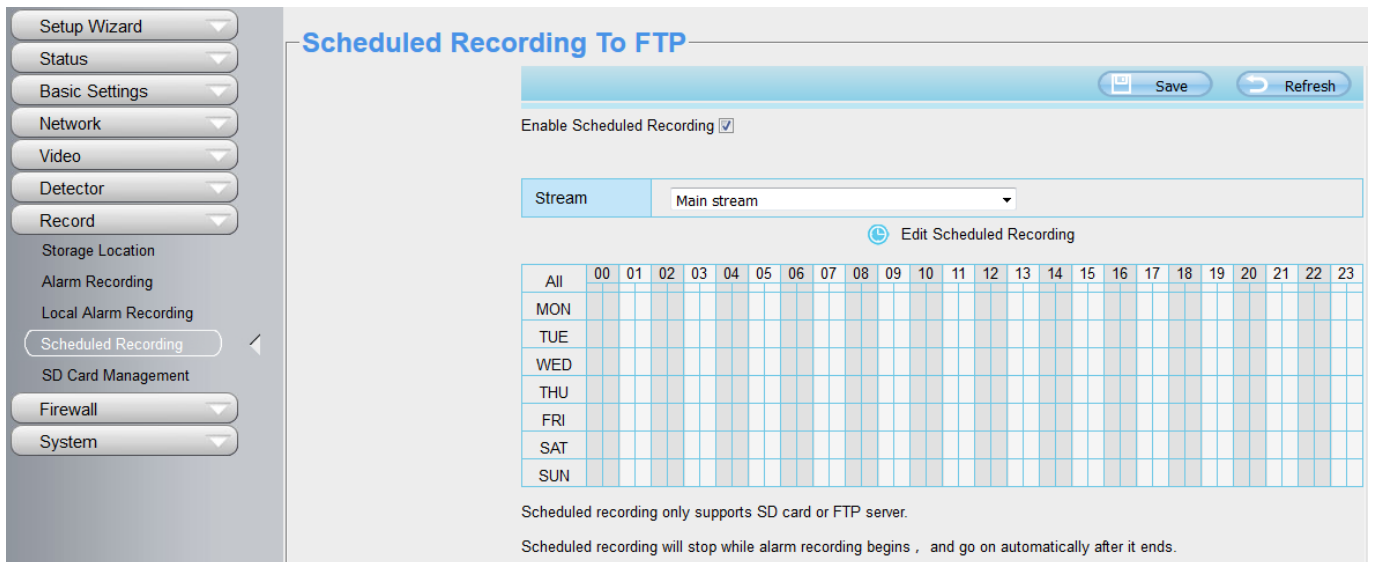
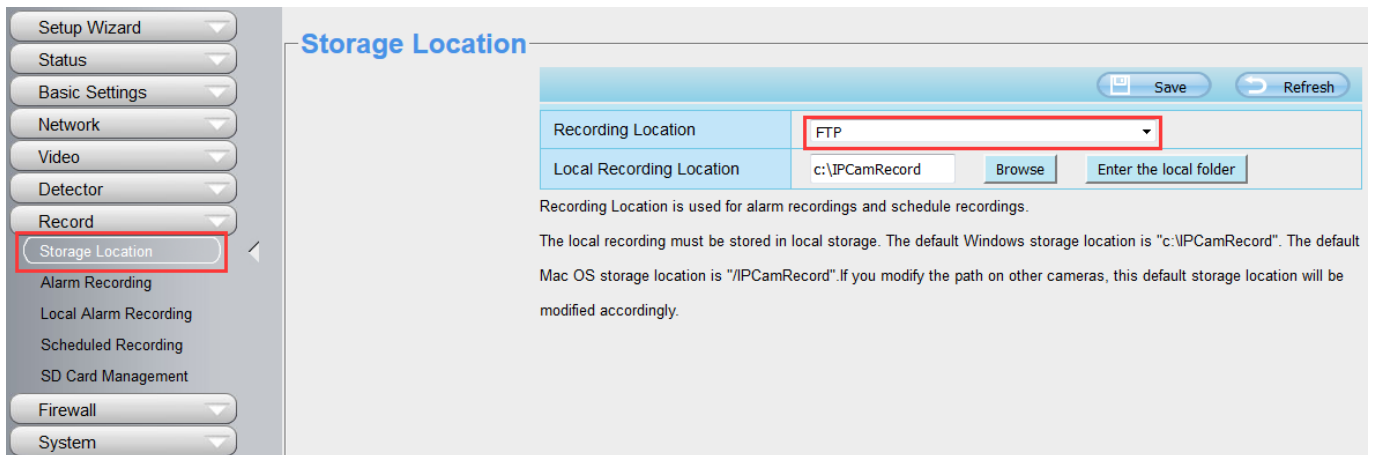

When the video is selected as SD card, the device supports pumping frame recording.

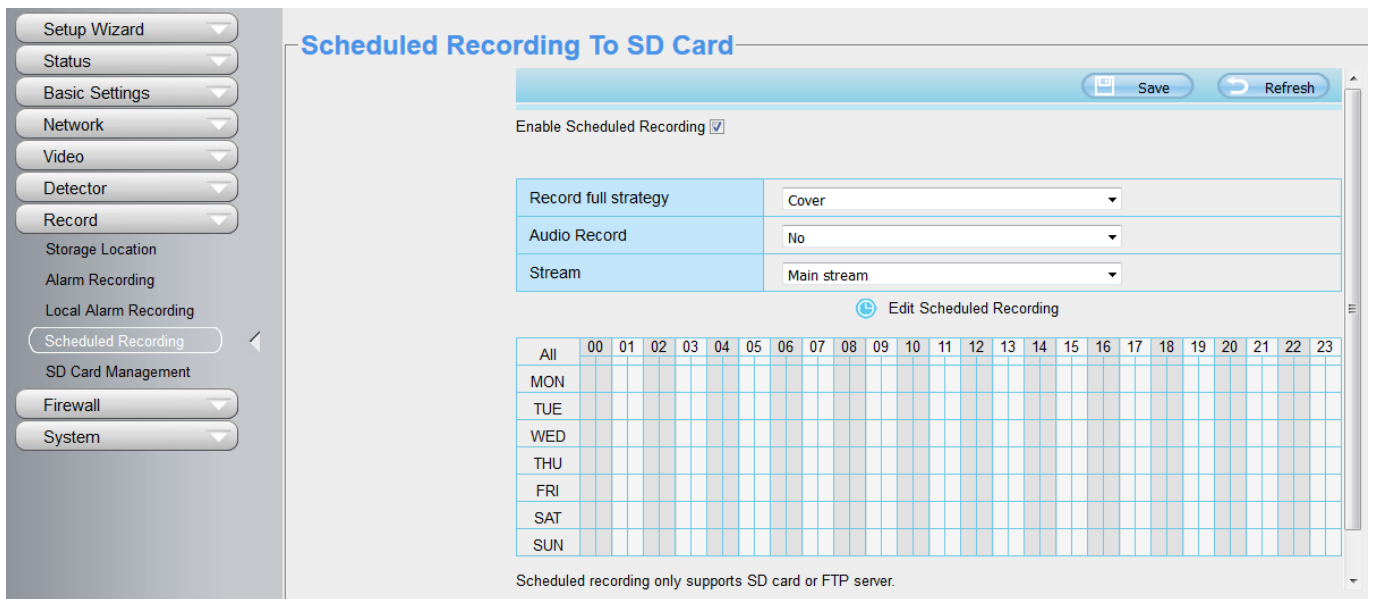
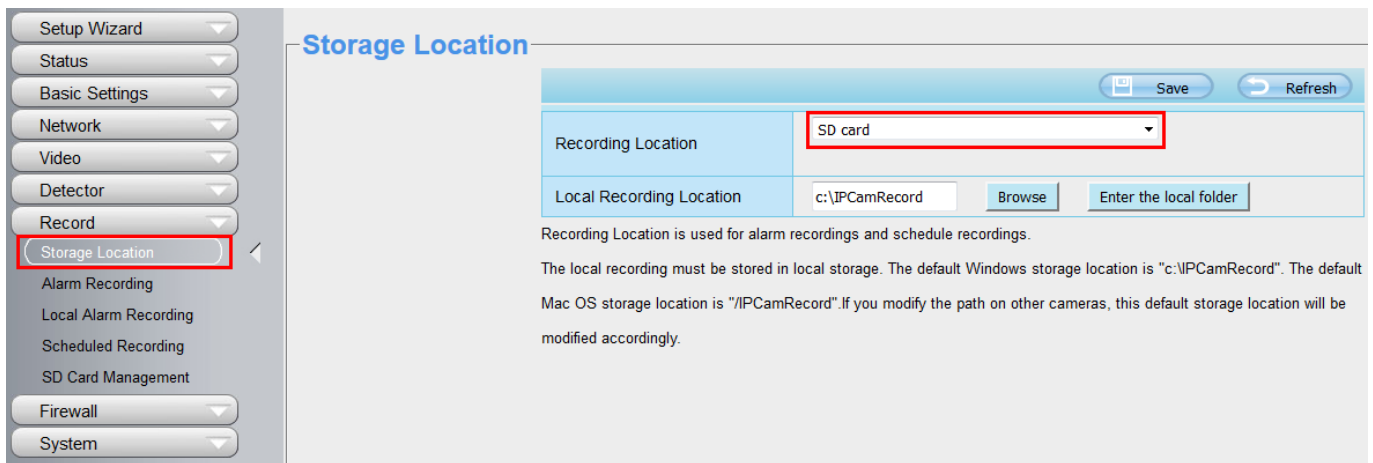

Record frame: There are six frame selections, such as 1 / 30, 4 / 30, 8 / 30, 15 / 30, 24 / 30, 30 / 30. Recommended default is 4 / 30. The greater the Frame rate is, the sharper picture quality is, and the greater of storage space is, the shorter the storage time is.

Record full strategy: When the SD card is full, you can choose to cover the previous recording, or stop recording.

NOTES:

- Scheduled recording only supports video saved to the SD card or FTP server.
- The schedule recording will stop while alarm recording is beginning, and it will continue automatically after alarm recording end.
- You can refer to [4.6 Motion Detection](#) > 5 Alarm Schedule. in **Alarm** about editing the time of recording Schedule.

4.7.5 SD Card Management

The SD card Slot inside the camera, if you want to install or remove the Micro SD card, you need to open the camera.

When you plug in the Micro SD card during the camera work process, please reboot the camera again, or else the SD Card may be cannot work well.

Go to the **Settings > Status > Device Status** page, you can see the SD card status.

The default storage path of alarm record files is SD card, when the available size of SD card is less than 256M, the old record files will be deleted automatically.

4.8 Firewall

This section explains how to control the access permission by checking the client PC's IP addresses. It is composed of the following columns: **Block access from these IP addresses** and **Only allow access from these IP addresses**.

IP Filtering	
Enable Firewall	<input checked="" type="checkbox"/>
IP Filtering	<div style="border: 1px solid #ccc; padding: 2px;">Block access from these IP addresses Block access from these IP addresses Only allow access from these IP addresses</div>
IP Address #1	<input type="text"/>
IP Address #2	<input type="text"/>
IP Address #3	<input type="text"/>
IP Address #4	<input type="text"/>
IP Address #5	<input type="text"/>
IP Address #6	<input type="text"/>
IP Address #7	<input type="text"/>
IP Address #8	<input type="text"/>

Enable firewall, If you select Only allow access from these IP addresses and fill in 8 IP addresses at most, only those clients whose IP addresses listed in the Only allow access from these IP addresses can access the Network Camera. If you select Block access from these IP addresses, only those clients whose IP addresses are in the IP list cannot access the Network Camera.

Click **Save** to take effect.

4.9 System

In this panel, you can back up / restore your camera settings, upgrade the firmware to the latest version, restore the camera to default settings and reboot the device.

4.9.1 Back-up & Restore

Click Backup to save all the parameters you have set. These parameters will be stored in a bin file for future use.

Click Browse and select the parameters file you have stored, then click Submit to restore the restore the

parameters.

Backup is used to save your current settings. It is recommended to backup your configuration before modifying or upgrading firmware.

Settings can be restored by uploading the backup file.

Path:

Note:

1. All current settings will be lost when importing a configuration file. If an incorrect file is loaded, the camera may stop working correctly.
2. Keep the power on during this process, or you may damage your camera. Your camera will reboot automatically once restoration is completed.

4.9.2 System Upgrade

Click **Download the latest firmware**, you will see the following screen. And click **Save** to save the firmware on your computer locally.

Your current firmware version will be displayed on your screen. You may go to the **Status > Device Information** page to check for the latest firmware versions available.

Click **Browse**, choose the correct bin file and then click **System upgrade**.

Don't shut down the power during upgrading. After upgrading, you can see the upgrade result.

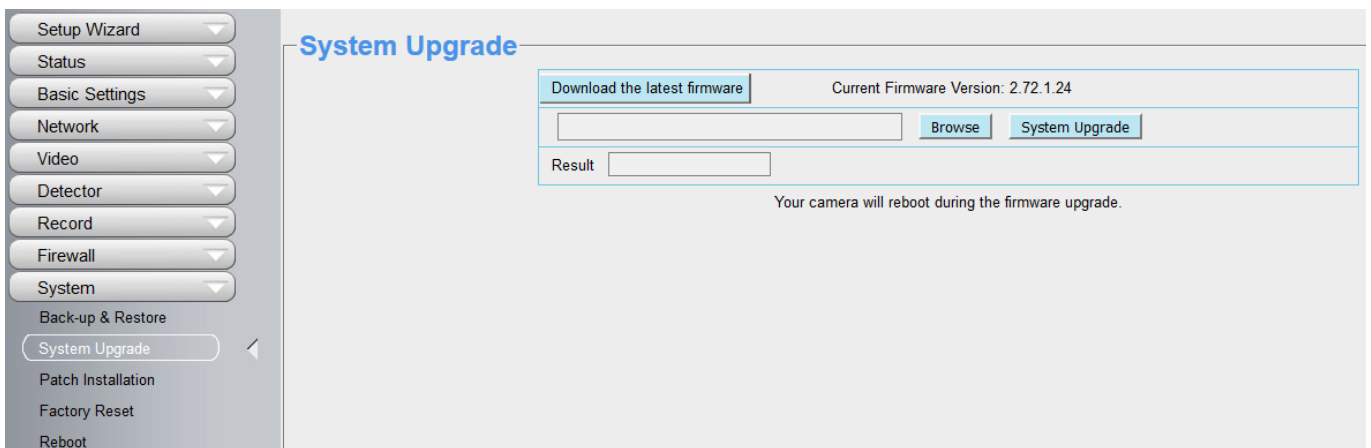

Upgrade Firmware by Equipment Search Tool

Double click the Equipment Search Tool shot icon  , select the Camera IP that you want to upgrade the firmware. Then select Upgrade Firmware and enter the username and password, choose the firmware file, and upgrade.

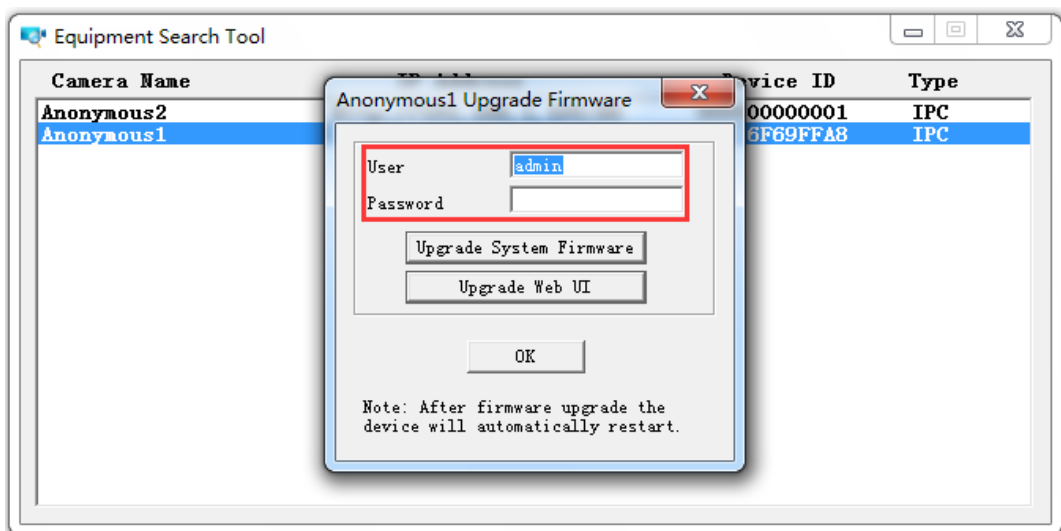
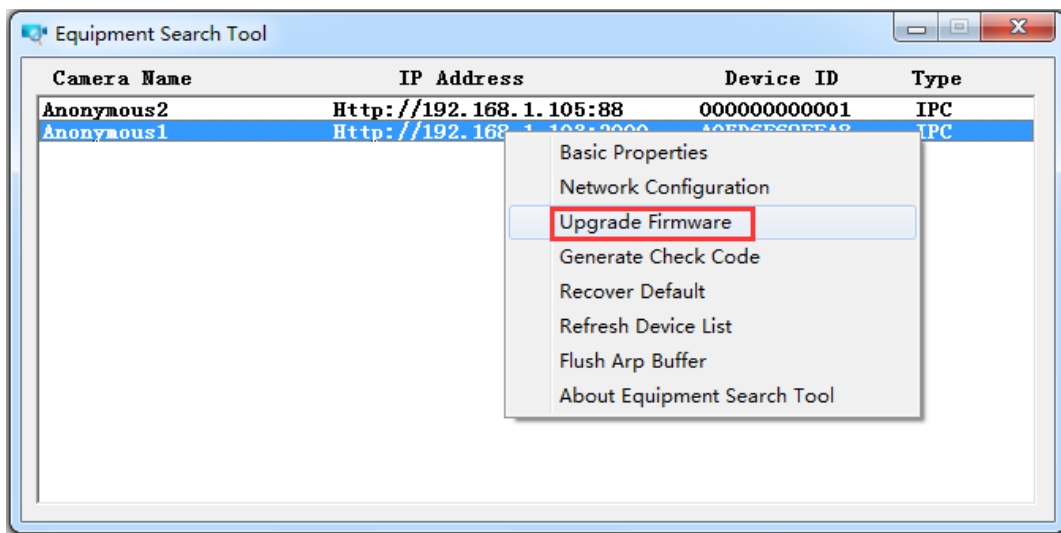

CAUTION:

We recommend that you regularly update your camera to the latest available software and firmware versions to help ensure the best experience for your camera.

NOTE:

- 1) Please ensure you have download the correct firmware package for your camera before upgrading. Read the upgrade documentation (readme.txt file) in the upgrade package before you upgrade.
- 2) Upon downloading the firmware check the sizes of the .bin files. They must match the size in the readme.txt file. If not, please download the firmware again until the sizes are the same. Your camera will not function correctly if a corrupt .bin file is used.
- 3) Never shut down the power of the camera during upgrade until the IP camera restart and get connected.
- 4) After upgrade successfully, please clear the cache of browser, uninstall the old plugin and re-install it, then reset the camera to the default factory settings before using the camera.

4.9.3 Patch Installation

Click **Browse** to select the correct patch file, and then click **Install Patch** to install the patch. Do not turn off the power during it installing. After installing is complete, you will receive a system prompt.



4.9.4 Factory Reset

Click **Factory Reset** button and all parameters will return to factory settings if selected. The default administrator username is admin with a blank password.

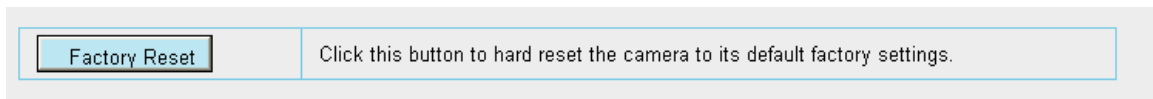

4.9.5 Reboot

Click **Reboot** to reboot the camera. This is similar to unplugging the power to the camera.

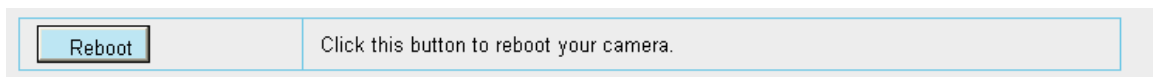

5 Playback

On this page you can view the record files stored in the SD card.

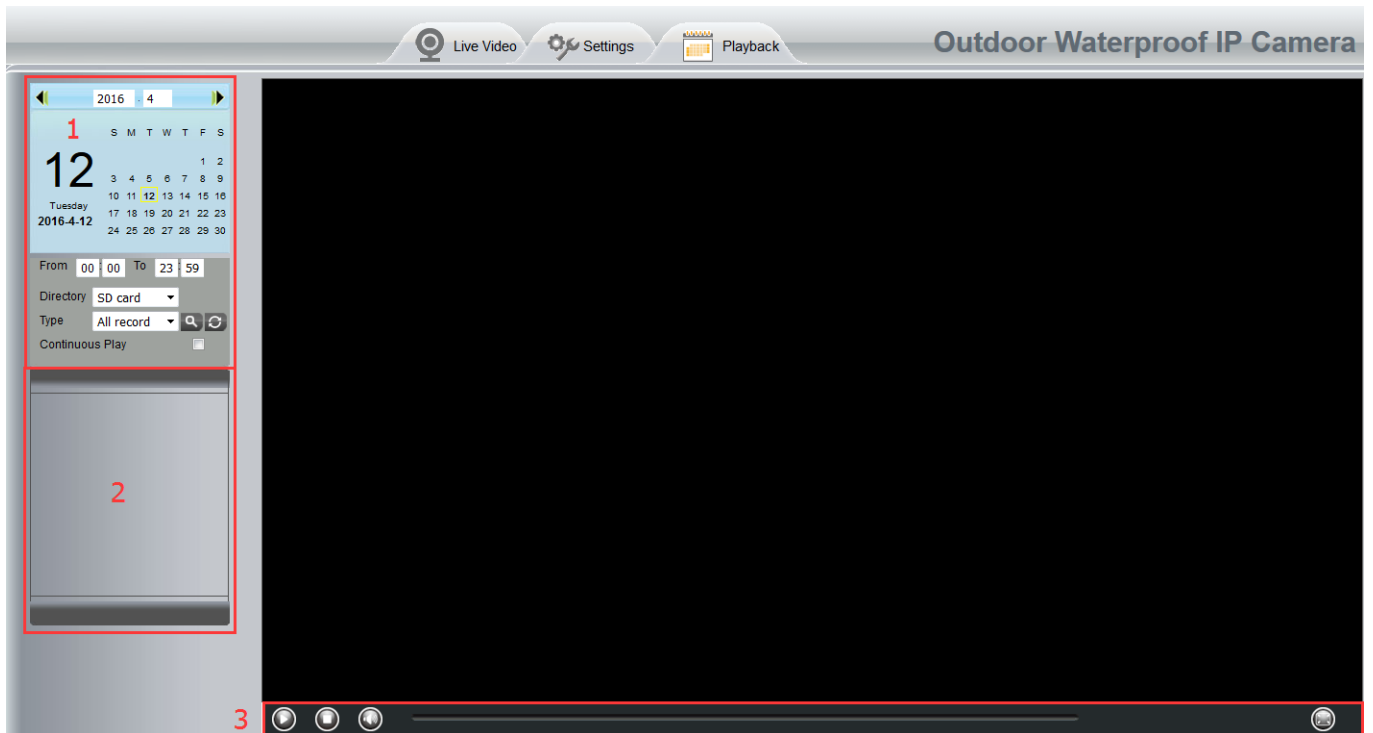

Section 1 Define the Record files time and Type

Directory : The storage path of record files

Time : Here supports three types: current day, current month and All records. Another way, select the time on the time&date manually.

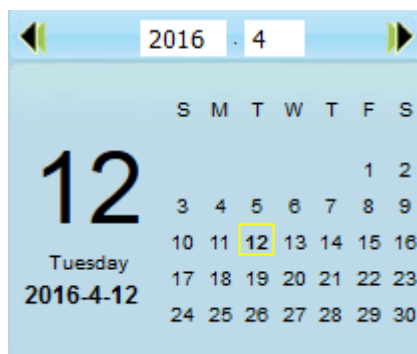

Type : The type of records files, Here supports two types: Normal record, Alarm record and All records.

: Click this button to search all record files satisfy the conditions you selected.

Continuous Play: Select the checkbox to play continuously all the record files.

Section 2 Search record files

On this panel you can see all record files satisfy the conditions you set.

Section 3 Play / Stop / audio / Full screen Buttons

Please select one record file before use these buttons.



Click this button to play the record files.



Click this button to stop the record files.



Click this button to audio on / mute.



Click this button to make full screen, and double click left mouse to exit full screen.

6 Appendix

6.1 Frequently Asked Questions

NOTE: Any questions you would meet, please check Network connections firstly. Check the working status revealed by the indicators on the network server, hub, and exchange. If abnormal, check the network connections.

6.1.1 Equipment search tool cannot find the camera

After power on camera and connect it to router by Ethernet cable, open Equipment Search Tool it cannot find any camera IP address. Shows a blank window like below.

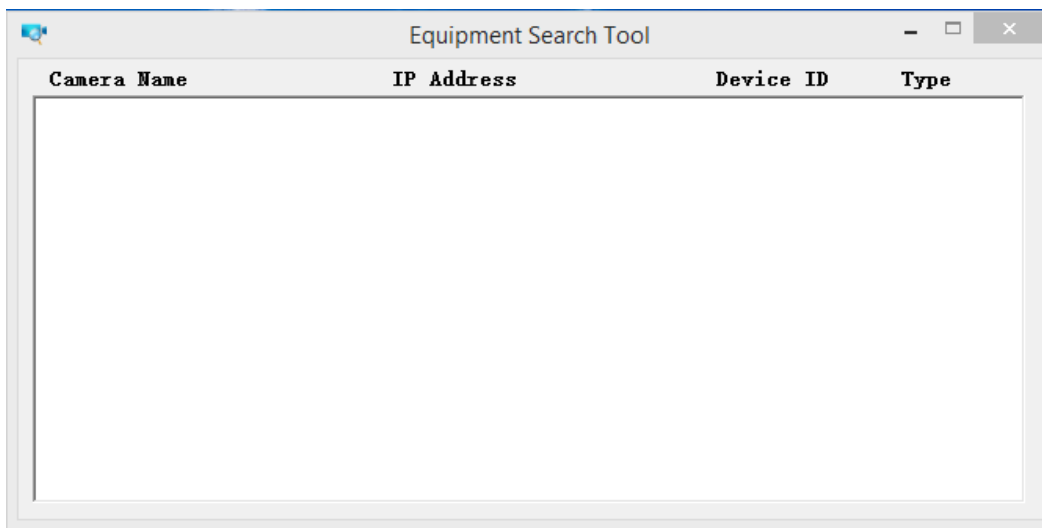

This is usually because camera doesn't get an IP in same network segment as the computer. Please follow below steps to fix the problem.

1. Make sure both camera and computer are connected to same router.
2. Make sure camera's connected to router properly and camera status is normal.
For indoor pan/tilt cameras, when powered on you will see a red power light and camera will pan/tilt. And on LAN port you'll see a blinking orange light and a solid green light.
3. Reset camera to have a check. Just keep pressing rest button on camera with power on for about 30 seconds till it reboot. Reset button is usually on back/bottom of camera, or on the end cords.
4. Try another Ethernet cable or hook into another LAN port on router.
5. Make sure the router DHCP server is enabled and there is no Mac address filter.
Check router's DHCP list as well, to see if you can find camera's IP address there.
If yes, please try to log-in the camera directly by manually input the IP address and port (default http port: for SD camera is 80, for HD camera is 88) of camera into address bar of web browser.
6. Please turn off any virtual machine or multiple connection (use only wired or wireless connection) that is running on computer.
7. At latest make sure there's no firewall is blocking Equipment Search Tool or other search tool conflicts with it.

6.1.2 Install plugin for Internet Explore

Suggest use IE browser to log in the camera and install the plugin for the first time, then you can use it on other browser as well. Just remember to allow the plugin to run. See below for steps to install plugin via IE browser.

Step 1: User IE browser to log in the camera for the first time, it will prompt to ask your install the plugin on the bottom of IE browser.

Step 2: Click **Install** to continue the installation of the .exe plugin.

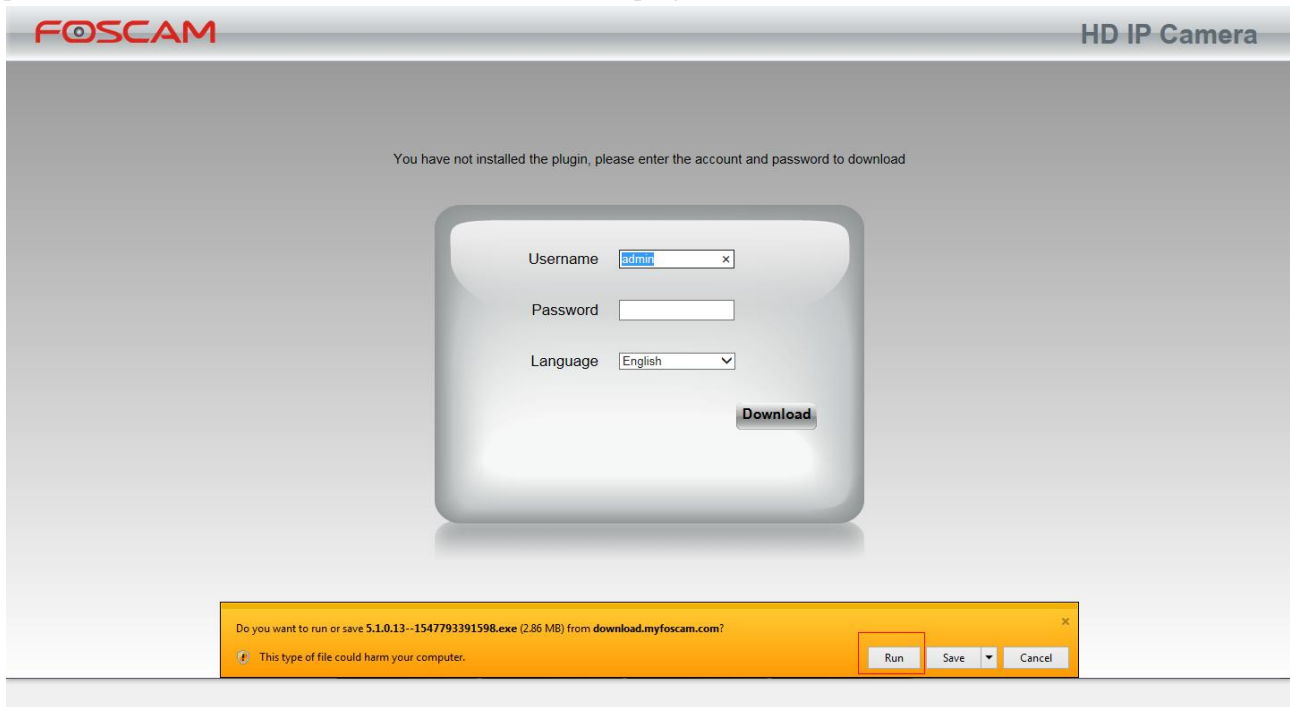

Step 3: Follow the Setup Wizard to finished installing the plugin

Note: When starting to install the plug-in, it will force to close the IE browser. Please click **Yes** to close the IE browser firstly.

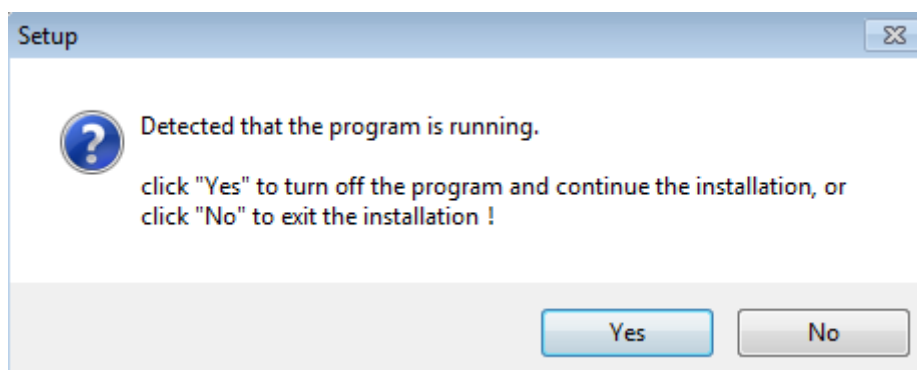

And click **Next** to follow the setup wizard.

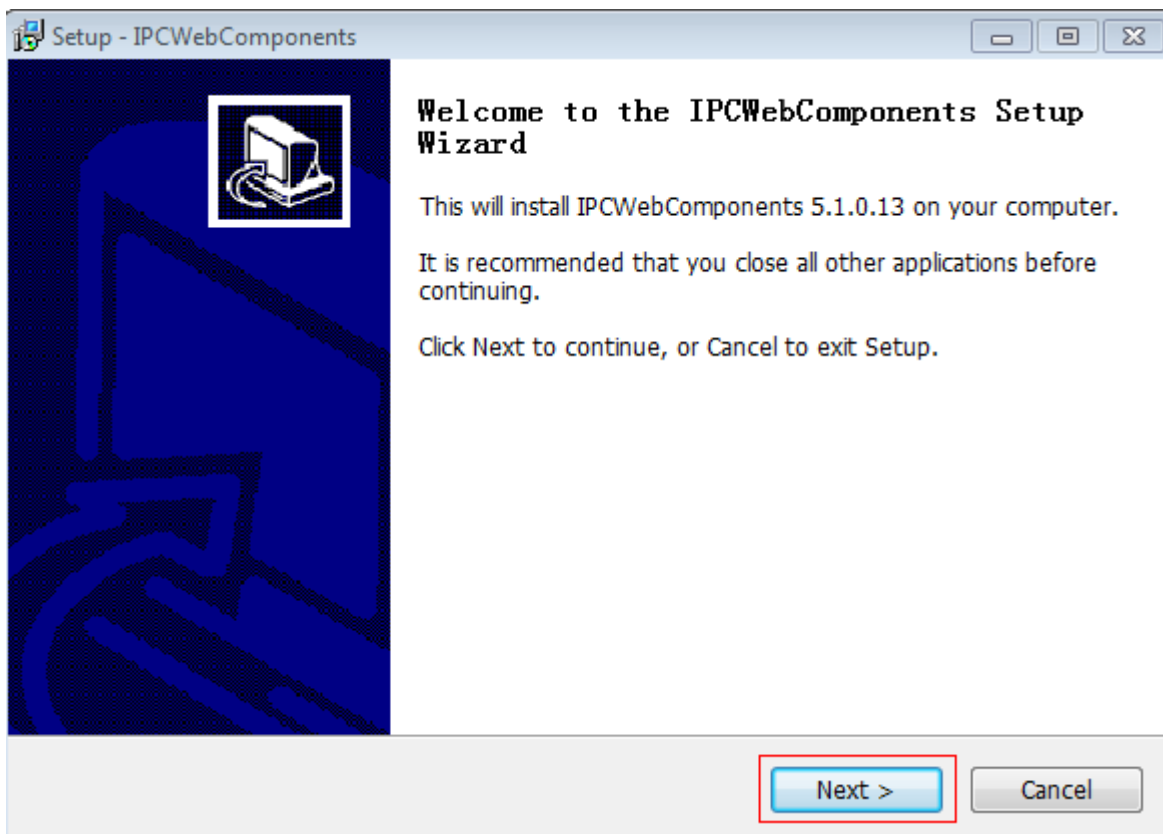
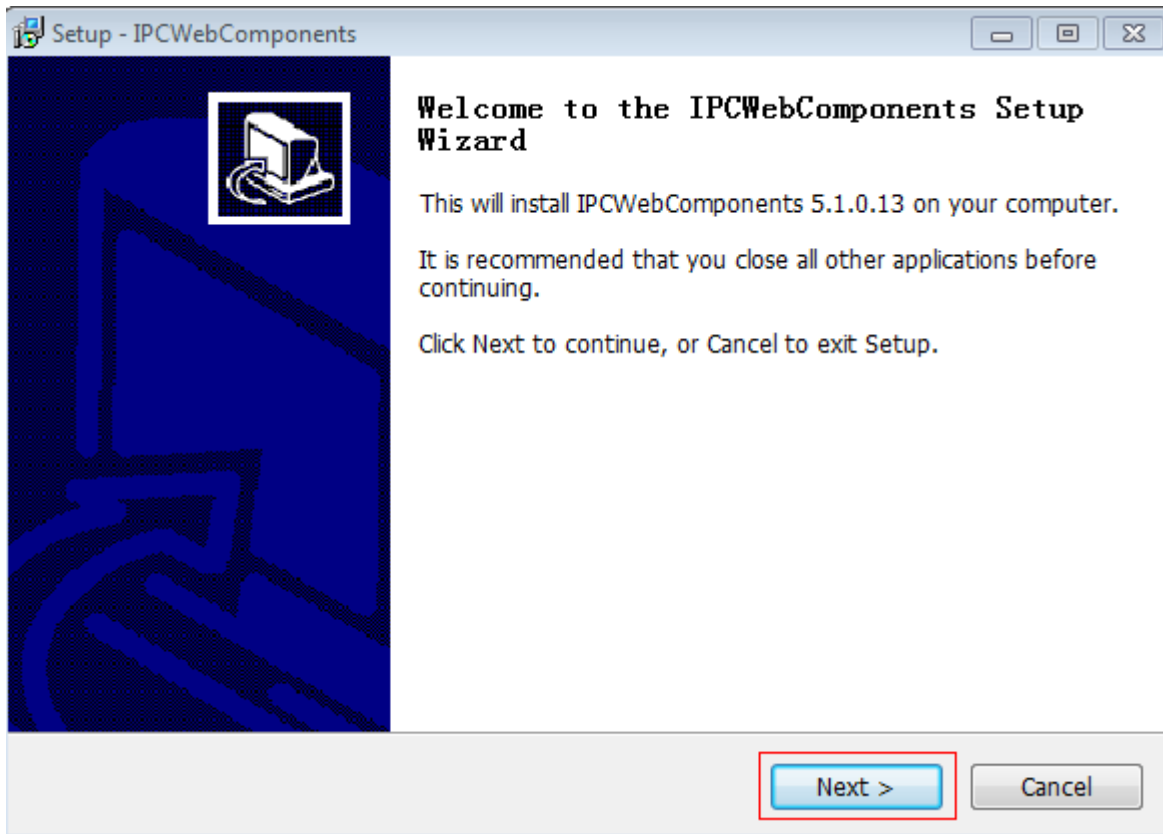

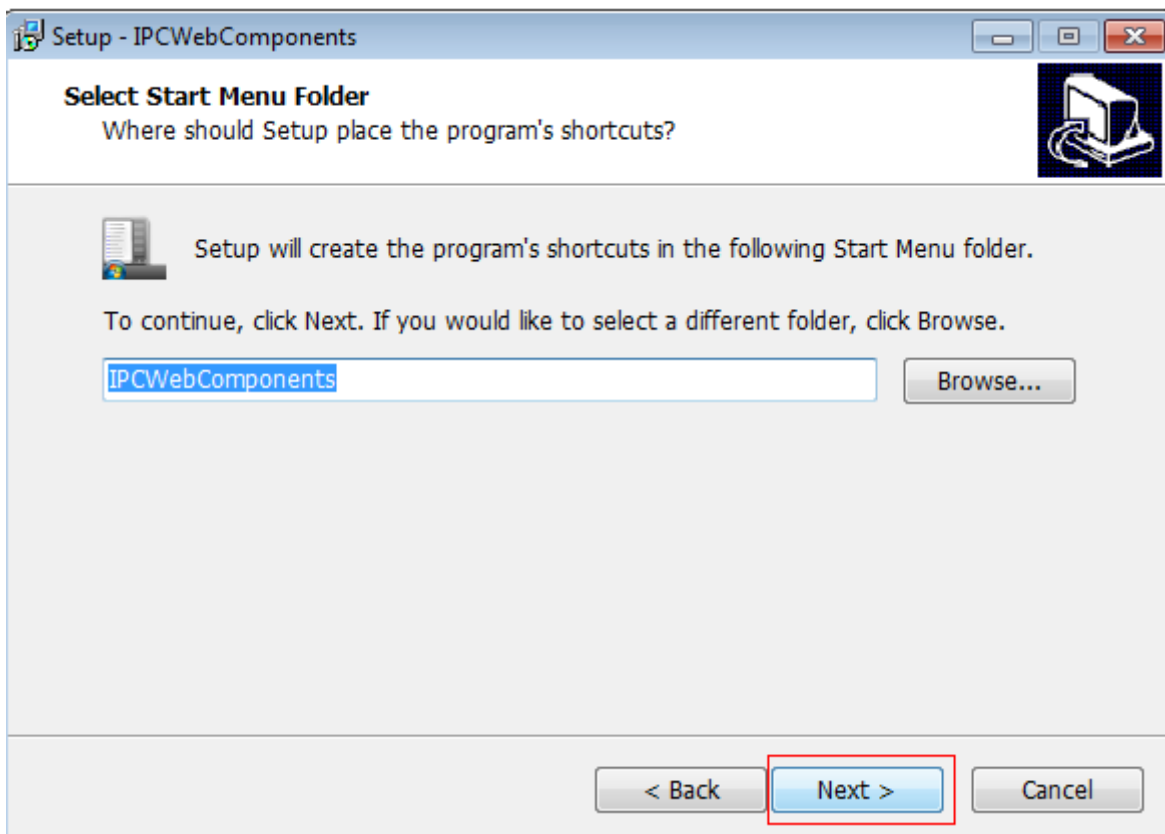
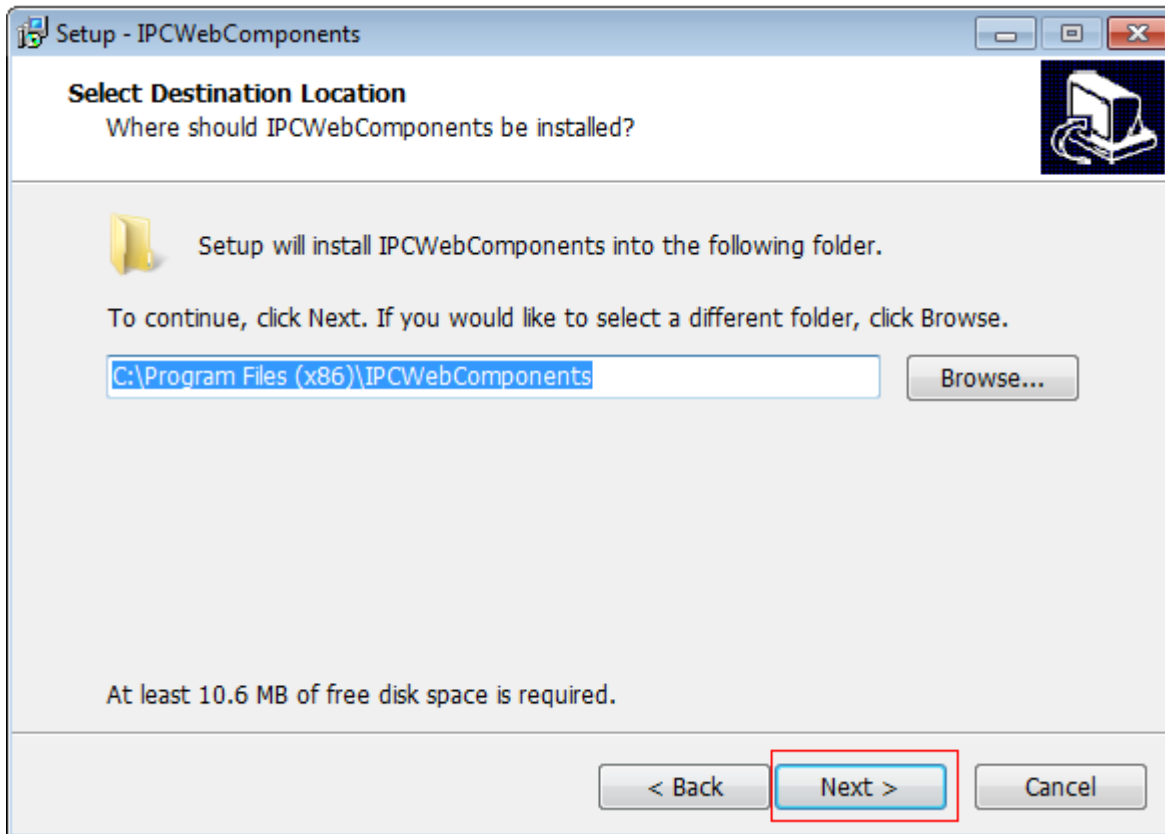

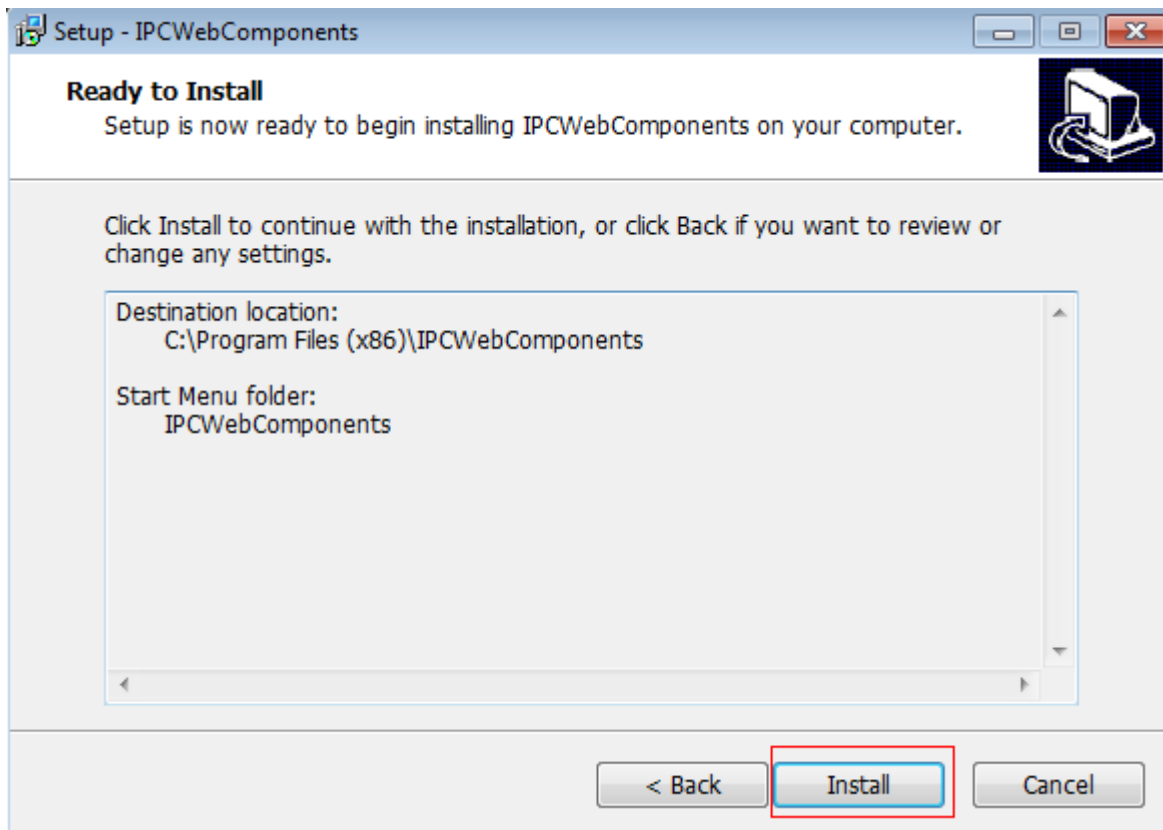

Step 4: Click **Finish** and reboot IE browser to log in the camera.

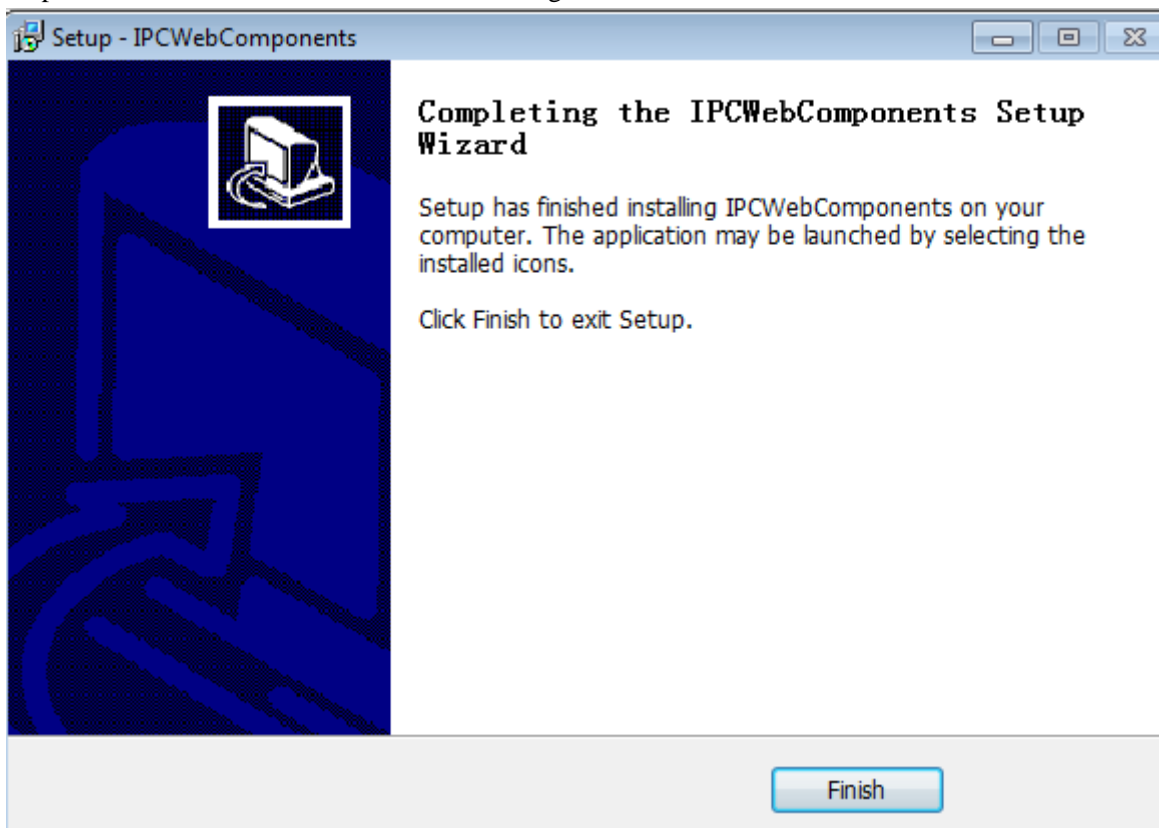

Note, for Safari on MAC OSX it'll show a link "Plugins are not found, click me to download" just above login windows of the camera. Please click it to download plugin and follow wizard to install. See this link for help if after installed plugin but still cannot login camera:

<http://www.foscam.com/faqs/view.html?id=14>

6.1.3 Unable to connect to router wirelessly

After setup wireless configuration, and input the wireless password correctly, save the settings. Normally, after you disconnect the Ethernet cable, wait for few minutes camera will show up again in Equipment Search Tool (or show up in router's DHCP client list/LAN list) with a new IP address. That indicates your camera's connected wirelessly.

If not, please follow below steps to help camera connect wirelessly.

Step1: Please make sure wireless signal is strong enough to connect with.

- (1) Make sure the camera antenna is fixed well;
- (2) Best to keep the distance between the camera and router in 2~3 meters while setup;
- (3) There's no interference or obstacles from house appliance or walls;

Step2: Please check if the frequency band of the wireless signal is 2.4GHz.

Our cameras only support connecting to 2.4GHz frequency wireless band. If your wireless router is dual band, that supports two frequency band 2.4GHz and 5GHz.

Please set the 2.4GHz and 5GHz with different SSIDs, and make sure configure camera to connect with the 2.4GHz SSID.

Step3: Please check if your wireless password contains special characters.

Remove special character in SSID and wireless password to have a try.

Step 4: Reboot camera and router to have a check.

If above are all confirmed, power off and on the camera and router may help camera to connect.

Step 5: Please log-in the router and check if the MAC filter feature is enabled.

Camera has wired and wireless MAC, they are different. If your router has wireless MAC filtering turned on, it'll block camera to connect. Please turn it off, or add camera's MACs in the allow list.

Step 6: Please change the wireless channel, and the wireless encryption of router to have a try.

Change channel helps reduce influence from nearby WiFi networks, you can try 3,6,or 11 for example. As for encryption, suggest use WPA2/PSK AES.

Step7: At last reset camera to default, and please try re-configure the wireless settings again.

6.1.4 Forgot camera's user name and password

Camera can be hard reset to default settings, when you forgot camera's login user name and password. Below are the steps:

- (1) Keep power on camera;
- (2) Press and hold reset button of camera for 30 second, till it reboots. Reset button is on bottom, or back, or end cords of the camera.
- (3) Once reset, camera will be restored to default settings. And default username is admin, no password (leave password blank).

6.1.5 How to setup alarm recording to SD card

For the cameras that support Micro SD card, we can save alarm recording on SD card and below are the steps to set it up:

Step 1: Setup the Motion Detection Settings

Please go to **Settings > Alarm > Motion Detection** menu.

- (1) Click **Enable**.
- (2) Choose **Recording** for the alarm action.
- (3) Set the Detection Area
- (4) Set a Schedule.
- (5) Click **Save** to save the settings.

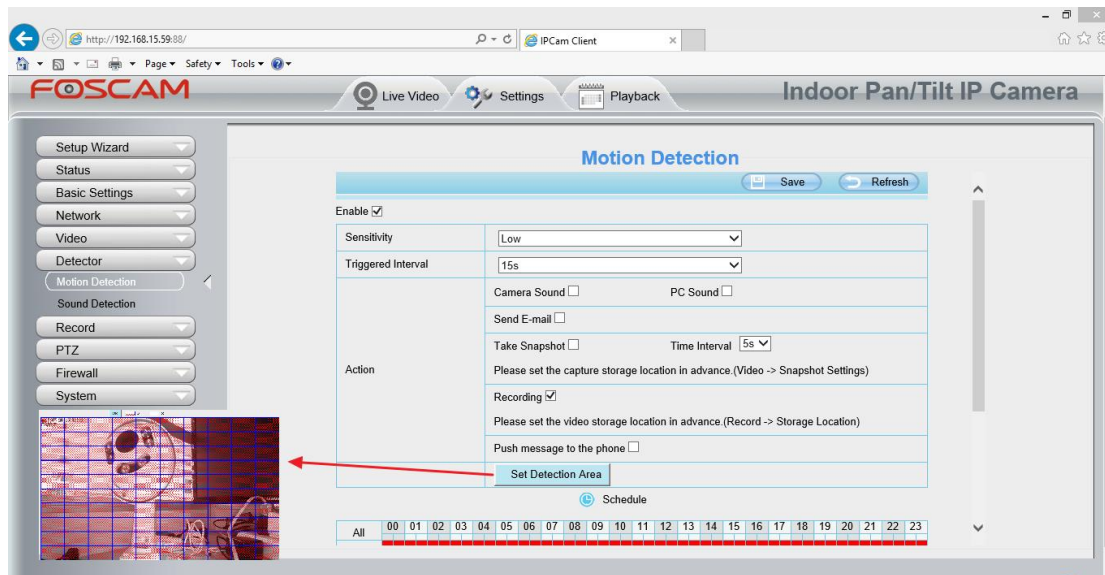

Note:

- 1) Please DO NOT forget to set the alarm schedule, the alarm schedule is red.
- 2) Please make sure your camera time is correct.
- 3) Please DO NOT forget to set the alarm area, the detected area is covered by the red grids. Or for some models you can setup 3 detection zones in total.

Step 2: Setup the Storage Location

Go to **Settings > Record > Storage Location**, and set the "Recording Location" to "SD card and click **Save**.

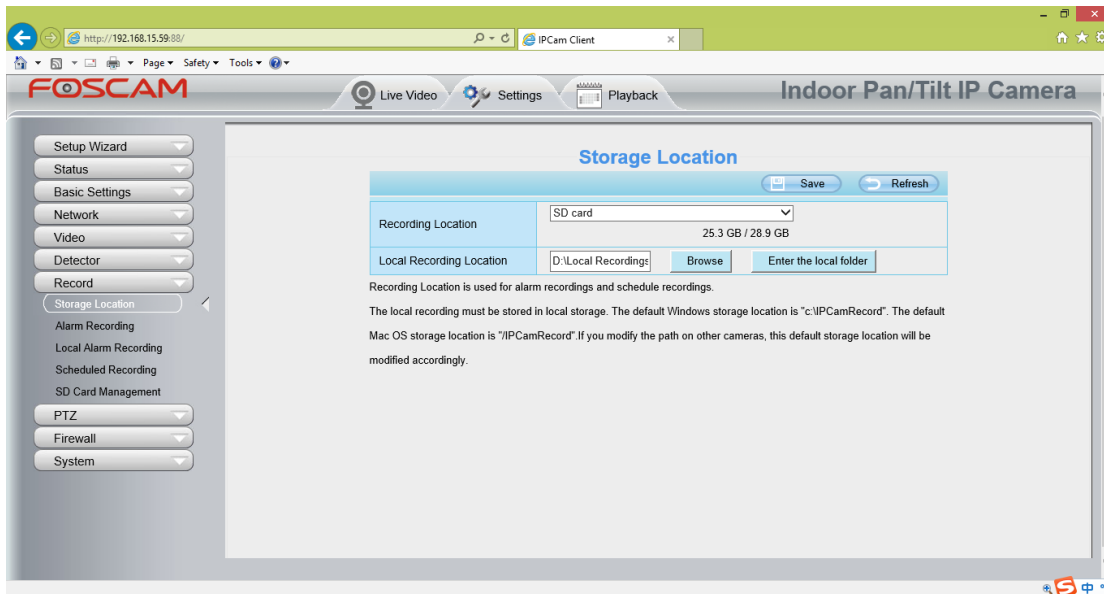

Note:

SD card needs format correctly so it'll be identified by camera, and has enough space for saving the recordings. It's suggested to use FAT32 for 4G~128G SD card.

6.1.6 How to setup alarm Emails

Setup alarm Emails, when camera detects a motion it'll send Email with snapshot to inform about the motion alarm. Steps as below.

Step 1: Setup Mail Settings

Before you set, please make sure that your email for sender enabled SMTP. And get your Email SMTP server, SMTP port, TLS information ready.

Please go to **Settings > Network > Mail Settings** menu to setup your email firstly.

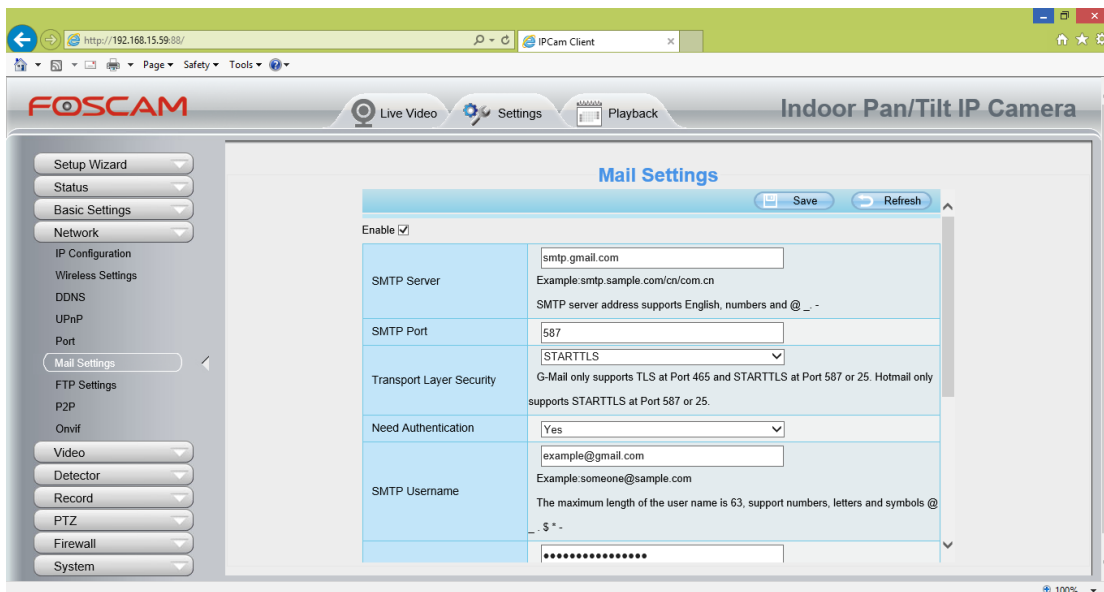

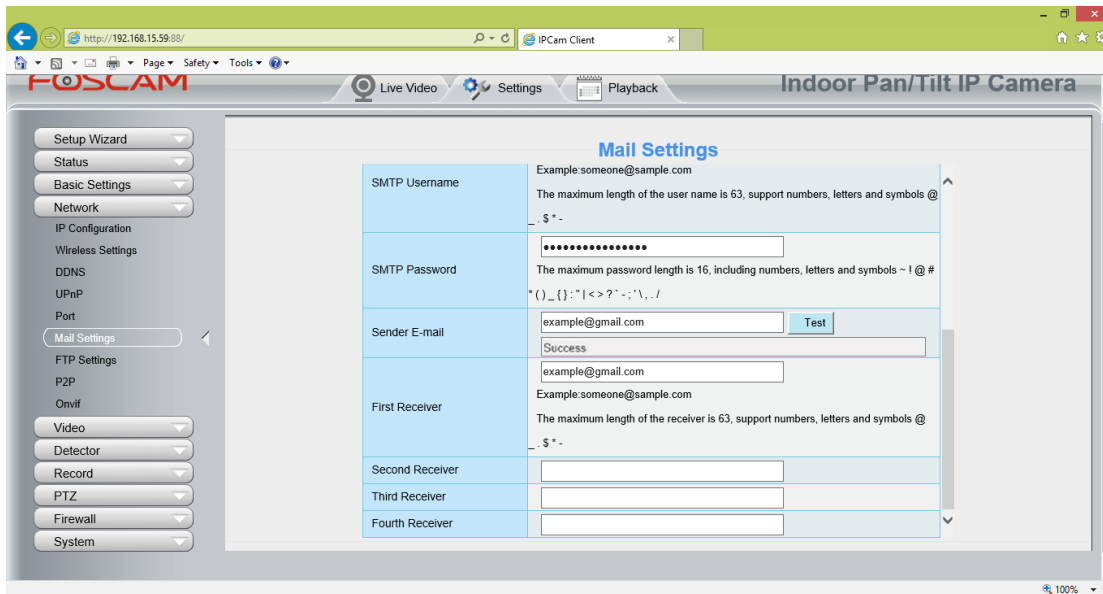

Note:

- (1) Please make sure that your sender email supports SMTP;
- (2) Please click on **Save** before you click on **Test**;
- (3) Make sure the test result is success.
- (4) After succeed, you will receive a test email in the mailbox of Sender.

Step 2: Setup the Motion Alarm Settings

Please go to **Settings > Alarm > Motion Detection** menu:

1. Click **enable**,
2. Choose **Send E-mail** for the alarm action,
3. set your detection area,
4. Set your schedule.

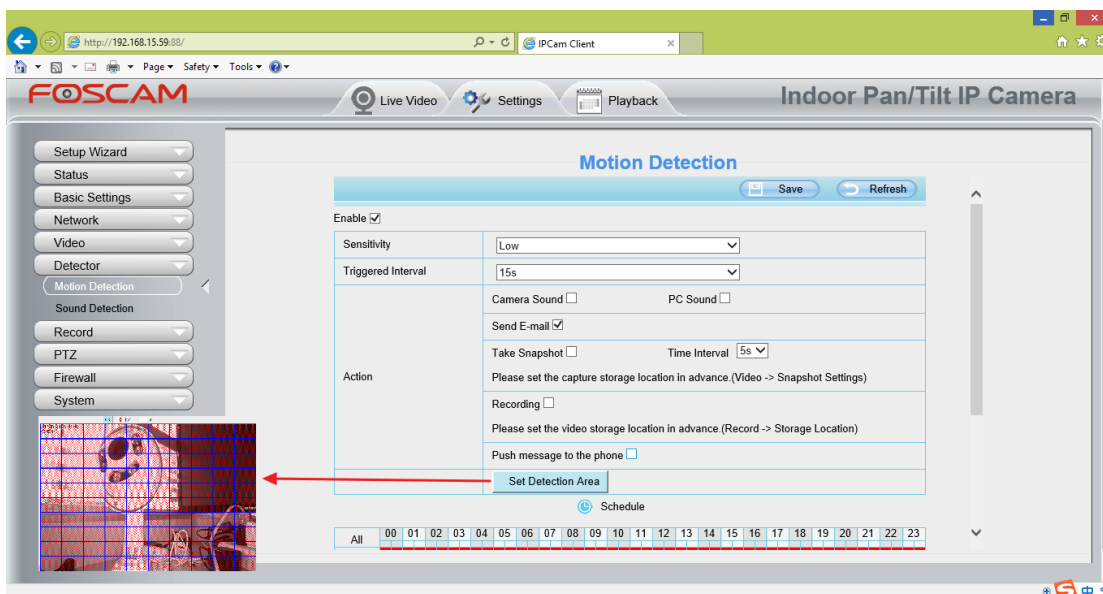

Do not forget to click on **Save** after you finish settings.

If there is motion trigger, camera will alarm and you can receive alarm emails.

Note:

- (1) Please DO NOT forget to set the alarm schedule, the alarm schedule is red.
- (2) Please make sure your camera time is correct.
- (3) Please DO NOT forget to set the alarm area, the detected area is covered by the red grids. Or for some models you can setup 3 detection zones in total.

6.1.7 Camera is not displaying image

Camera unable to show live image on web browser cloud be caused by multiple factors.

- (1) Plugin is not installed or running properly.

Please install plugin first, go to **IE Browser > Tool > Internet Option > Security > Custom Level > ActiveX control and Plug-ins**. Three options of front should be set to be **Enable**, The ActiveX programs read by the computer will be stored. As follows:

Enable: Download unsigned ActiveX controls.

Enable: Initialize and script ActiveX controls not marked as safe.

Enable: Run ActiveX controls and plug-ins.

- (2) Low network bandwidth that's unable to transfer image. Please lower resolution of the camera.
- (3) IR-cut is stuck at night when IR lights are on. In this case, manually turn off and on IR lights a few times.
- (4) Also, if camera's firmware is too old that doesn't support the browser and unable to install plugin will cause the same issue. Please update firmware of the camera to latest first.

6.1.8 Unable to connect camera remotely using Foscam app

Foscam P2P cameras allow users to connect camera remotely using Foscam app without extract setup like port forwarding. When it unable to connect remotely, below tips can help app establish the connection:

- (1) Update app and camera's firmware to latest version,
- (2) Power off the camera then power back on,
- (3) Delete camera from app then re-add it back, also lower camera's resolution.

6.1.9 Camera is added by others

When use myfoscam.com cloud or Foscam app, one camera can only be added to one account at the same time. To solve error "This camera has already been added by another account" when add camera to Foscam app or cloud, please send a clear photo of camera's model sticker to Foscam support email support@foscam.com to unbind it.

More FAQs are available here:

<https://www.foscam.com/faqs/index.html>

6.2 Default Parameters

Default network parameters

IP address: obtain dynamically

Subnet mask: obtain dynamically

Gateway: obtain dynamically

Username and password

Default admin username: admin with a blank password

6.3 Specification

Image Sensor	Sensor	High Definition Color CMOS Sensor
	Display Resolution	2.0 Megapixels
	Min. Illumination	0 Lux (With IR Illuminator)
Lens	Lens Type	Glass Lens
	Focal Length	f: 2.8mm
	Aperture	F1.8
	Angle of View	Horizontal:113° Diagonal :133°
Video	Image Compression	H.264
	Image Frame Rate	25fps (1080P) /11fps (720P) /, downward adjustable
	Resolution	1080P(1920x1080),720P(1280 x 720), VGA(640 x 480), QVGA(320 x 240)
	Stream	dual stream
	Image Adjustment	The hue, brightness, contrast, saturation, sharpness are adjustable
	Flip Image	flip and mirror
	Infrared Mode	Automatic or manual
Network	IR Range	Infrared lamp array, IR LEDs for IR range up to 10 meters (33ft)
	Ethernet	One 10/100Mbps RJ45 port
	Remote Access	P2P
	PoE	IEEE. 802.3af
System Requirements	Network Protocol	IP, TCP, UDP, HTTP, HTTPS, SMTP, FTP, DHCP, ARP, P2P, RTSP, ONVIF
	Operating System	Microsoft Windows 2000/XP, Vista, 7; Mac OS
Other Features	Browser	Microsoft IE8 and above version or compatible browser; Google Chrome; Apple Safari.
	Motion Detection	Alarm via E-Mail, upload alarm snapshot to FTP
	User Accounts	Three levels user role
	Firewall	Supports IP Filtering
	Storage	Micro SD card, FTP and local storage
Power	Reset	Reset button is available
	Power Supply	DC 12V / 1.0A
	Power Consumption	4.5 Watts (Max.)

Physical	Dimension (L * W * H)	112.5mm * 112.5mm * 88mm / 4.4in * 4.4in * 3.5in
	Net Weight	700g / 1.5lb
Environment	Operating Temperature	-20°C~ 60°C (-4°F ~ 140°F)
	Operating Humidity	20% ~ 85% non-condensing
	Storage Temperature	-20°C ~ 60° (-4°F ~ 140°F)
	Storage Humidity	0% ~ 90% non-condensing
Certification	CE, FCC, RoHS,WEEE	

6.4 CE & FCC

Electromagnetic Compatibility (EMC)

FCC Statement



FCC Warning

This device complies with Part 15 of the FCC Rules. Operation is subject to the following two conditions: (1) This device may not cause harmful interference, and (2) this device must accept any interference received, including interference that may cause undesired operation. NOTE 1: This equipment has been tested and found to comply with the limits for a Class B digital device, pursuant to part 15 of the FCC Rules. These limits are designed to provide reasonable protection against harmful interference in a residential installation. This equipment generates, uses and can radiate radio frequency energy and, if not installed and used in accordance with the instructions, may cause harmful interference to radio communications. However, there is no guarantee that interference will not occur in a particular installation. If this equipment does cause harmful interference to radio or television reception, which can be determined by turning the equipment off and on, the user is encouraged to try to correct the interference by one or more of the following measures:

- Reorient or relocate the receiving antenna.
- Increase the separation between the equipment and receiver.
- Connect the equipment into an outlet on a

circuit different from that to which the receiver is connected. -Consult the dealer or an experienced radio/TV technician for help.

This equipment complies with FCC radiation exposure limits set forth for an uncontrolled environment. This equipment should be installed and operated with minimum distance 20cm between the radiator & your body.

NOTE 2: Any changes or modifications to this unit not expressly approved by the party responsible for compliance could void the user's authority to operate the equipment.

CE Mark Warning



This is a Class A product. In a domestic environment, this product may cause radio interference, in which case the user may be required to take adequate measures.

6.5 WARRANTY

FOSCAM values your business and always attempts to provide you the very best of service.

No limited hardware warranty is provided by FOSCAM unless your FOSCAM product ("product") was purchased from an authorized distributor or authorized reseller. Distributors may sell products to resellers who then sell products to end users. No warranty service is provided unless the product is returned to an authorized return center in the region where the product was first shipped by FOSCAM or to the point-of-purchase, which may have regional specific warranty implications.

If you purchase your FOSCAM product from online store, please contact the point-of-purchase and ask for return / replacement / repair service.

Limited Hardware Warranty

FOSCAM products are warranted to be free from manufacturing defects in materials and workmanship starting from the shipping date of FOSCAM.

This limited hardware warranty does not cover:

- Software, including the software added to the products through our factory-integration system, software, etc.
- Usage that is not in accordance with product instructions.
- Failure to follow the product instructions.
- Normal wear and tear.

Return Procedures

- Please read FOSCAM warranty policy & policy of your reseller first before sending items back to point-of-purchase.
- Customer must first contact point-of-purchase to obtain a Return Merchandise Authorization (RMA) number before returning the product. If the product you received is suspected to be defective and the product warranty has not expired, The RMA number will allow your reseller to track your return much easier and help them expedite processing your request.
- After receiving your RMA case number, pack the item(s) very well with the original box and all the original accessories included such as power adapters, brackets, cables, manuals.
- Write your RMA number and the return reason (the problem of the product) on the warranty card along with the complete package to send them back.

Replacement Services

- **If customers ask for replacement service, please contact point-of-purchase and follow their policy.**
- Our technicians will inspect all items returned for replacement requests. If the returned product is found in working order, we will return the same item received. However customers shall be responsible for all

shipping & handling charges incurred for getting the units back to customers.

- If returned products are found defective, we will replace the product and assume the shipping cost for sending back the replacement unit to customers.
- If for any reason, we are unable to provide a replacement of the original returned item(s). You will have a choice for a "Substitute" item at the same equal value.
- We do not provide exchange and replacement due to normal hardware upgrade according the market after 14 days after the product is delivered.
- Our technicians will test the product before send out the replacement, any other demand for more than two times replacement for the same product during replacement limit will be rejected.
- **Replaced products are warranted from the balance of the former warranty period.**

Warranty Forfeiture

- Warranty is void if purchase from unauthorized distributor or reseller.
- **Warranty is void if trade-mark, serial tags, product stickers have been removed, altered or tampered with.**
- Warranty is void for mishandling, improper use, or defacing the product.
- Warranty is void for physical damage, altered, either internally or externally, improper or inadequate packaging when returned for RMA purposes.
- Warranty is void if damage has resulted from accident, dismantle, abuse, or service or modification by someone other than the appointed vendor, source, fission or the spare part has been over the period of warranty.
- Warranty is void if product is damaged due to improper working environment or operation. (For example, improper temperature, humidity, unusual physical or electrical stress or interference, failure or fluctuation of electrical power, static electricity, using wrong power adapter, etc.)
- Warranty is void if damaged by the use of parts not manufactured or sold by FOSCAM.
- Damage caused by improper installation of third-party products.
- Warranty is void if damaged for irresistible cause, such as earthquake, fire, lightning, flood, etc.
- Product beyond limited warranty.

Shipping Fee

- If products are defective or damaged under normal use or operation in the replacement limit, distributors or resellers are responsible for the shipping cost the product back to customers, customers should assume the shipping cost send the product to the point-of-purchase.
- During replacement limit, if customers ask for replacement due to the product does not fit for customer's personal expectation, customers should responsible for both shipping fee.
- Customers shall be responsible for both shipping fee if their product beyond the replacement limit but still in warranty limit.

Repair Service Out Of Warranty

- FOSCAM provide extra repair service for product that out of warranty, it is chargeable. The total fee contains device cost and service fee. Device cost (including accessories) is the standard uniform price provide by FOSCAM.
- Different region may have different service fee, please contact the point-of-purchase to confirm that before you ask for this service.
- Our technicians will quote the total price after detect the product, If customers refused to repair after the quotation, customers need pay for the test fee, \$3.5 / hour. If agree with the quotation, test will be free.

- Repaired product out of warranty will obtain 3-month warranty from the date of the product back to customers.

Limitation of Liability

- FOSCAM is not responsible for other extra warranty or commitment promised by resellers, if your reseller promised some extra commitment or warranty; please ask for written documents to protect your rights and interests.
- FOSCAM does not offer refunds under any circumstances. Please contact the point-of-purchase and follow their refund / return policy.
- FOSCAM shall not be liable under any circumstances for any consequential, incidental, special or exemplary damages arising out of or in any connection with this agreement or the products, including but not limited to lost profits, or any claim based on indemnity or contribution, or the failure of any limited or exclusive remedy to achieve its essential purpose or otherwise. Purchaser's exclusive remedy, as against FOSCAM, shall be the repair or replacement of defective parts. If FOSCAM lists a product on its website specification in error or that is no longer available for any reason, FOSCAM reserves the right to explain it without incurring any liability.

All rights reserved. FOSCAM and the FOSCAM logo are trademarks of ShenZhen FOSCAM Intelligent Technology Limited., registered in the U.S. and other countries.

6.6 Statement

You are advised to be cautious in daily life, keep personal account information carefully, do not share personal account easily. Change passwords of your account and equipment periodically, and upgrade equipment firmware to strengthen security consciousness.

Our company makes no warranty, implied or otherwise, that this product is suitable for any particular purpose or use. You need to abide by the relevant laws and regulations of the use restrictions when using Foscam cameras. Our company takes no responsibility of illegal activities by using our products.

Our company takes no responsibility of the loss by force majeure, such as failure or faults of telecom system or the Internet network, computer viruses, malicious attacks of hackers, information damage or loss, and faults of computer system.

Foscam company does not need to take any responsibility of the special, incidental or corresponding loss by the products of our company or any software provide by our company, including but not limited to operating loss, profit or purpose. The company only takes the responsibility applicable to national and local legal requirements.

Our company takes no responsibility of the loss caused by the following at any time:

- 1) loss of purchases;
- 2) loss of intangible property damage, such as data, programs;
- 3) loss of compensation claimed by third-party customers.

Delete images, format the memory card or other data storage devices does not completely remove the original image data. You can restore deleted files from discarded the storage device by commercial software, but which will potentially lead to personal image data used maliciously by others. The privacy of the data security belongs to user responsibility, the company takes no responsibility.

Parts mentioned in this statement should not be understood by the configuration description of the product purchased by the customer, the product configuration must accord to the specific models purchased by the customer.

Without the prior written permission of Foscam company, all the contents of relevant operating instructions manual affiliated to the product must not be reproduced, transmitted, transcribed or stored in a retrieval system, or translated into other languages.

Our company will reserve the right to improve and modify the product and corresponding manuals. The company reserves the right of final interpretation on our products.

7 Obtaining Technical Support

While we hope your experience with the IP camera network camera is enjoyable and easy to use, you may experience some issues or have questions that this User's Guide has not answered.

If you have problem with FOSCAM IP camera, please first contact FOSCAM reseller for solving the problems. If our reseller cannot provide service, please contact our service department:

support@foscam.com



CE Certificate statement Website:

<http://www.foscam.com/company/ce-certificate.html>

Exporter and Importer Information Opened to Public: <https://www.foscam.com/company/open-information.html>

Manufacturer: Shenzhen Foscam Intelligent Technology Co., Ltd

Addr: 9/F, Block F5, TCL International E City, No.1001

ZhongShanyuan Rd., NanShan District, Shenzhen, China, 518055